

HIOKI

Next Generation Automotive
Measurement Solution Series

NEW

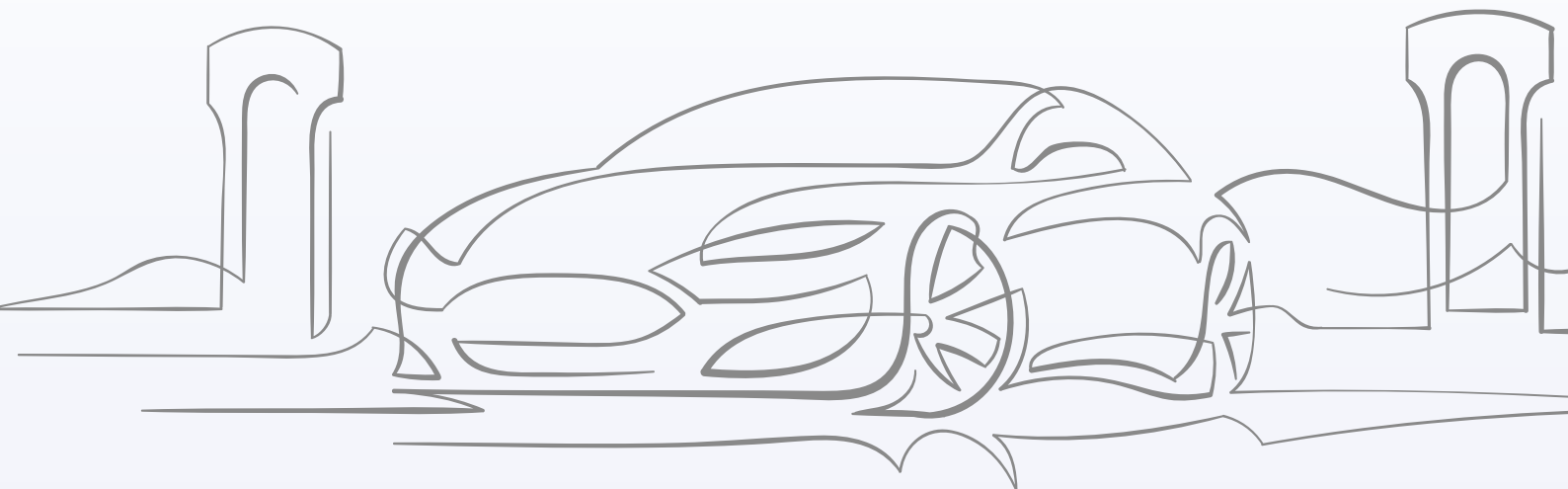

HIOKI's Next Generation Automotive Measurement Solutions



CE



Fast Charging Stations -----3

Power Systems -----4

Batteries -----6

Automotive Electronics -----8

Maintenance -----10

Wireless Power Transmission Evaluation System -----11

Fast Charging Stations



Fast Charging Stations

Evaluate EV Fast Charging Stations During Development

Conduct motion assessment by simultaneously recording output voltage, current and control signals in EV fast charging stations.

- Directly measure up to 1000 V DC (700 V AC) with the MR8905 module
- Ensure testing and equipment safety with all-channel isolation
- Using the MR8904, you can freely select specific signals from the CAN-bus and convert them into analog or logic signals (output voltage/current into EV CAN control signals).

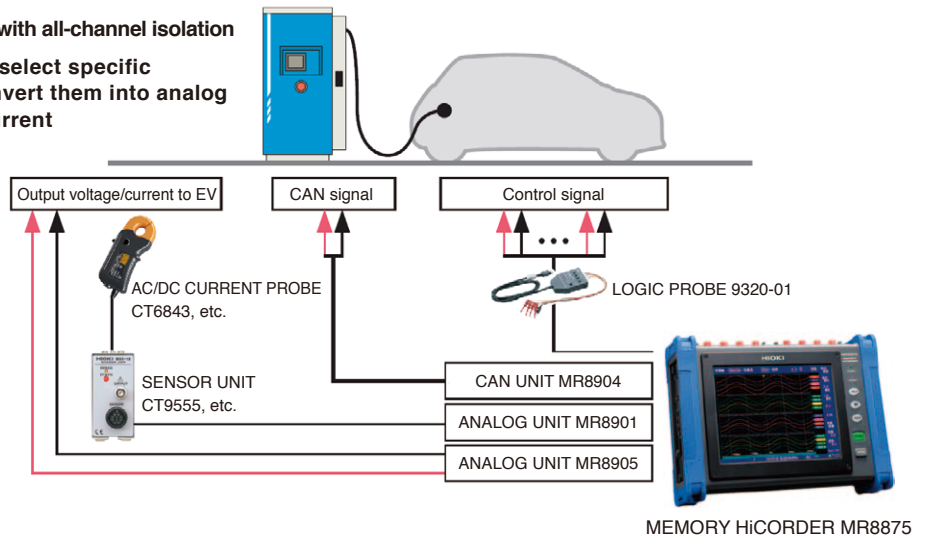

Verify the Power Quality of EV Fast Charging Stations

2-Fold Testing

Assess the power quality of a fast charging station's input (AC) and output (DC). At the same time, measure the inversion efficiency between the input and output.

- The voltage of CH 1, 2, 3, and 4 are isolated, enabling the POWER QUALITY ANALYZER PQ3198 to simultaneously measure both power and efficiency
- Evaluate the primary input (AC) and secondary output (DC) of the fast charging station at the same time

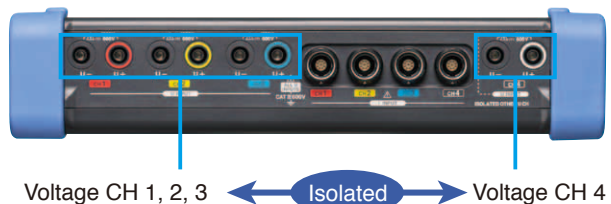

POWER QUALITY ANALYZER PQ3198

Power Systems

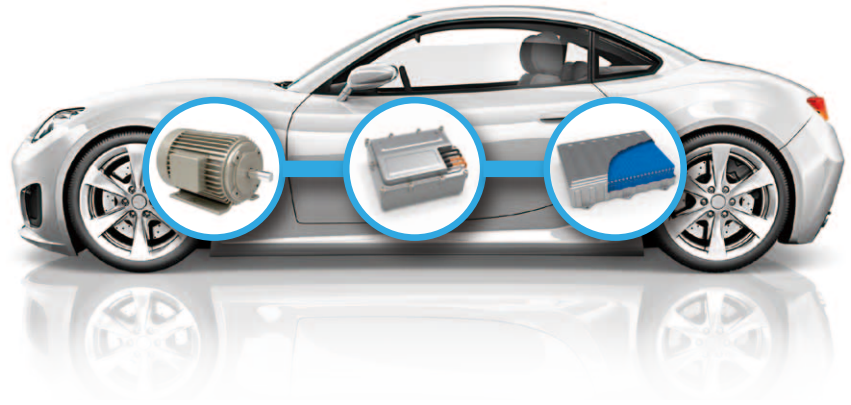

Power Conversion of Power Systems

Assess Motor Integrity

Evaluating a vehicle under actual driving conditions is an indispensable part of the development process.

During assessment, motors are tested under many states including idle-stopping/starting, switching between the motor and engine, while generating or charging electricity, electric power-only driving, auxiliary electric power driving, braking energy recovery system, and idling.

POWER ANALYZER PW6001 series

- 10 ms sampling rate
- Automatically measures and adjusts to fluctuating frequencies starting at 0.1 Hz
- Generates X-Y charts of motor characteristics

- Peak (max.) torque
- Rated torque
- Peak power
- Rated power
- Energy conversion efficiency
- Rotation speed range
- Operating voltage
- And more...

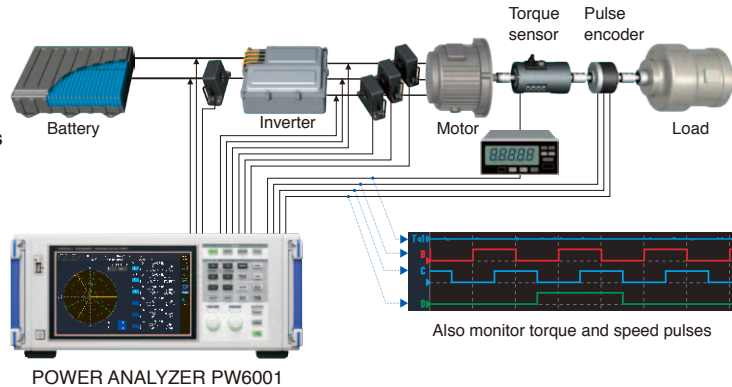

Evaluate the Electric Control of Motors

Compatible with Next Generation Switching Devices

Higher switching frequencies enable the miniaturization of passive components and low ON resistance, resulting in lower loss. The HIOKI POWER ANALYZER PW6001 is fully equipped to properly measure inverters and motor systems characterized by low power loss by delivering the following functions:

- Phase correction technology for HIOKI current sensors
- FFT frequency analysis
- High CMRR (excellent noise resistance)
- Simultaneous measurement of 2 motors (motors for driving & generation, and driving & regeneration)

Measurement example of two motors

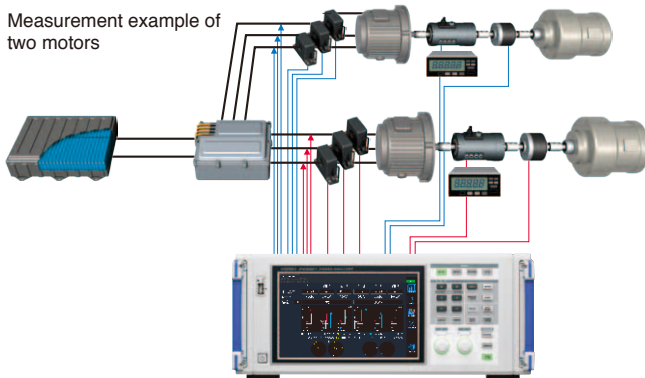

POWER ANALYZER PW6001

AC/DC CURRENT SENSOR CT6904 frequency characteristics (typical)

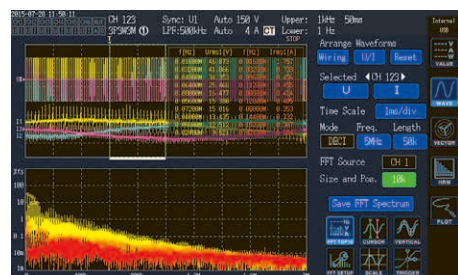
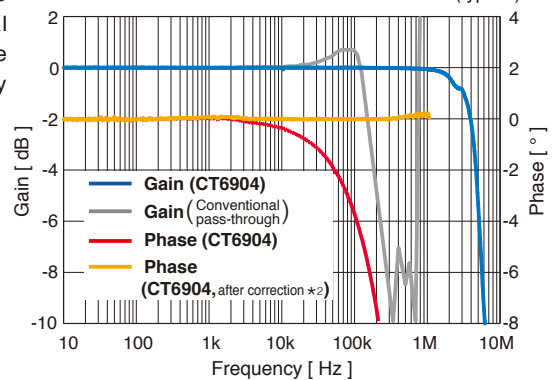

Power Systems

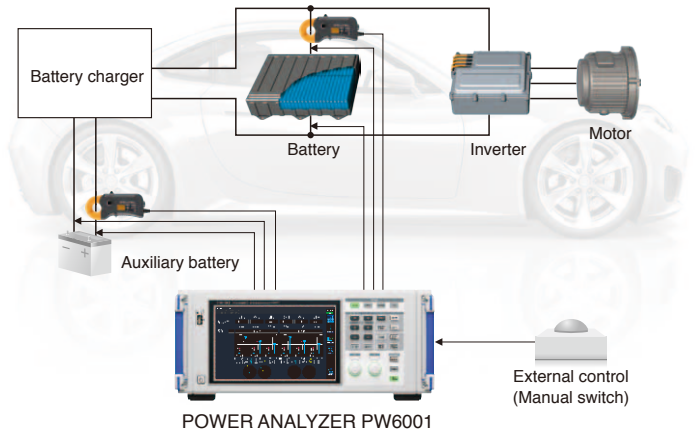

Energy Consumption Assessment Tests

Compliant with the WLTC (World Light vehicles Test Cycle) WLTP Standards

Working in tangent with our own high accuracy clamp current sensors, HIOKI power analyzers support needs for the highest accuracy measurements of integrated current and power charge/discharge tests of battery packs in EV systems.

- Excellent DC power accuracy
- High-precision sensors (operating temperature range: -40°C to 85°C [-40°F to 185°F])
- Integrated power of charging/discharging according to polarity at a sampling rate of 5 MS/s

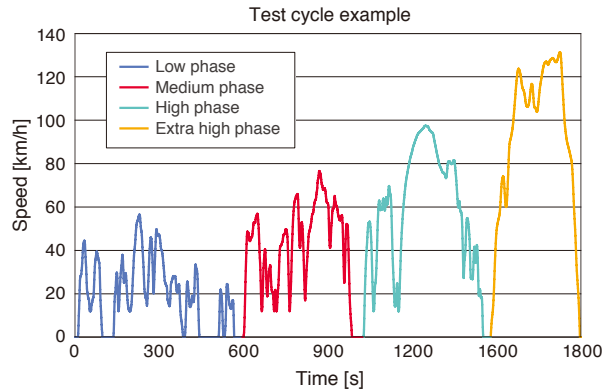

Charging/Discharging Current and Power Integration Function

To attain the DC integration values, the charge/discharge power is calculated and summed up for each polarity at a sampling rate of 5MS/s. Achieve accurate measurements even when the charge/discharge is repeated over extremely short intervals.

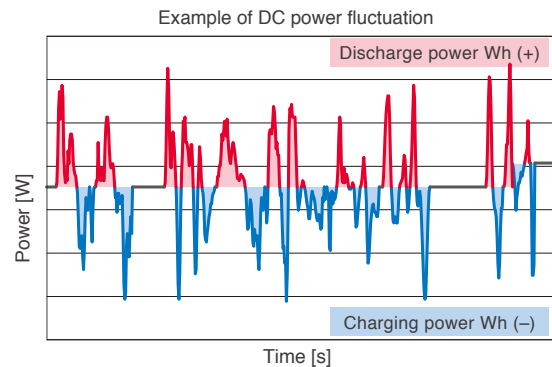

Advanced Current Sensors

Select the sensing method best suited for your situation: high-current (2000 A) and high-accuracy pass-through sensors, easy-to-use clamp sensors that don't require wire-cutting, or direct connection elements with high-accuracy and wide frequency bandwidth.

- High-precision AC/DC
- Wide operating temperature suitable for harsh environments

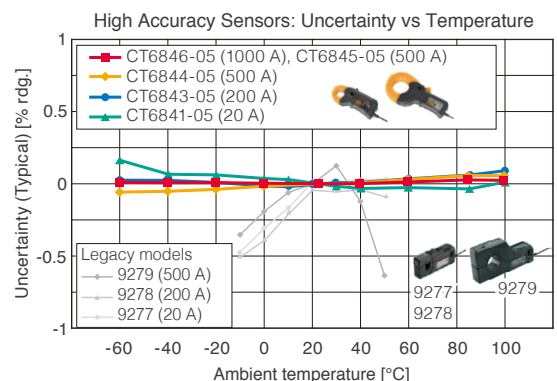
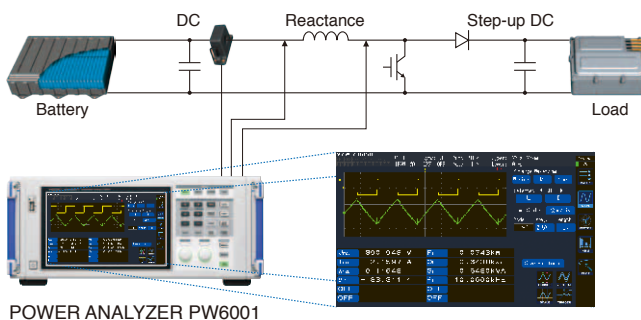
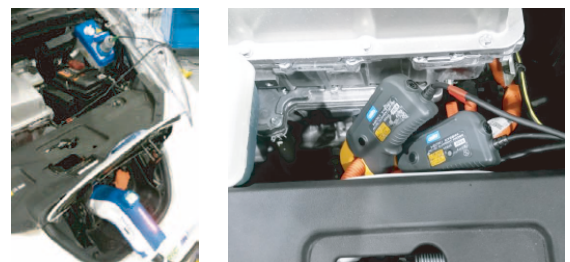

Batteries



Compliance Testing of Batteries

The battery, which bears the responsibility of delivering all of the energy in an electric vehicle, must offer safety and a long service-life.

An EV usually contains hundreds or even thousands of battery cells, and safe operation is dependent on maintaining consistent stability for all the battery cells in use.

In order to ensure consistent electrical characteristics when assembling battery cells into modules, assessment and screening of individual cells are required.

- Simultaneous high speed measurement of battery voltage (OCV) and internal battery resistance (IR)



BATTERY HITESTER BT3562

Quickly identify defective batteries through AC-IR and OCV testing.

New Solution

Traditionally, for DC-IR calculation, it is usually necessary to carry out charge/discharge tests to obtain current/voltage data points and to log the results over a long period of time. With the HIOKI BT4560, you can now dramatically reduce test time by determining the state of battery deterioration through the direct testing of electrolyte resistance and reaction resistance. The method utilizes the testing of small currents and low frequency signals, as well as frequency sweeping, to find battery failures. As an added bonus, batteries are not compromised during measurement.

- Resistance, reactance, and voltage
- 0.1 Hz to 1050 Hz



BATTERY IMPEDANCE METER BT4560

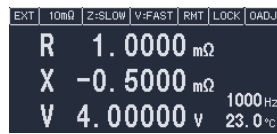

BT4560's minimum measuring time: approx. 10 seconds

Battery diagram

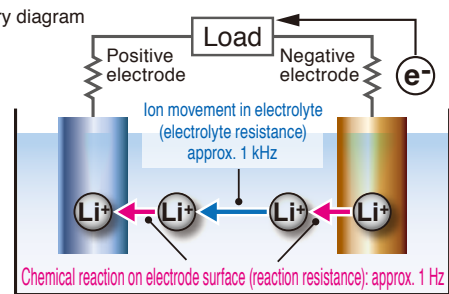

Equivalent circuit of battery

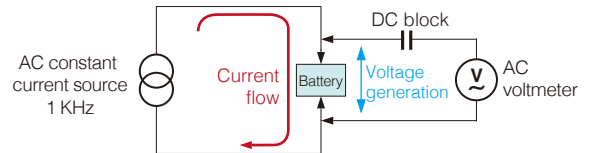
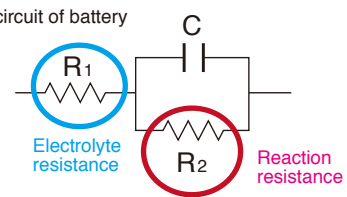

Enhance service life of battery modules by checking internal resistance

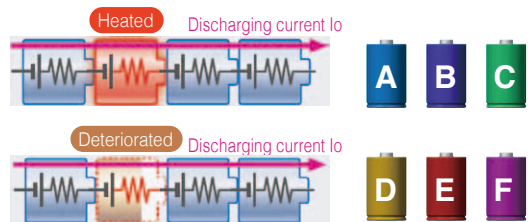

Checking the battery deterioration level

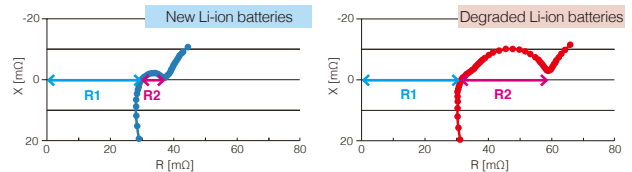

Batteries



Test High-voltage Battery Packs

Conduct high-voltage DC testing at 1000 V with the BT3564. An anti-spark function prevents arcs or sparks that tend to occur during high-voltage testing.



BATTERY HiTESTER BT3564

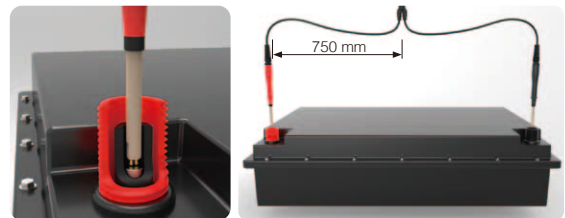

Connection Testing of Battery Systems

Check the reliability of electrical connections and the connection tabs and wires in a battery system. When there is a defect in the welding, resistance will increase in the joints, leading to heat emission and damage during charging and discharging. You can monitor for the increase using the precise capabilities of the RM3545.

- Test DC resistance to determine the connection state
- Resistance range: 0.00 $\mu\Omega$ to 1200 M Ω ; resolution: 0.01 $\mu\Omega$



RESISTANCE METER RM3545

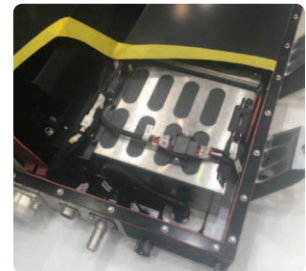

Thermal Management of Batteries

It is well-known that temperature can affect a battery. For the batteries used in vehicles, it is absolutely necessary that safety is ensured under different driving conditions and external environments.

Compact and portable, the LR8400 series feature multiple channels and a fastest measuring time of 10 ms, features that are perfect for use both in the lab and during actual driving tests.

- Monitor the temperature of batteries
- Conduct battery thermal safety tests



MEMORY HiLOGGER LR8400

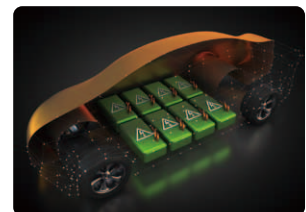

Battery Management Systems (BMS)

- Evaluate BMS by emulating battery operation
- Use with HILS (Hardware-in-the-Loop Simulation) validation for battery SOC, SOH estimation

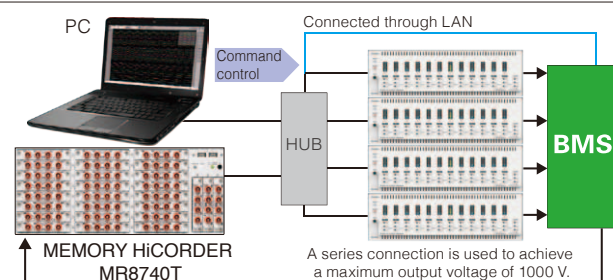

Automotive Electronics

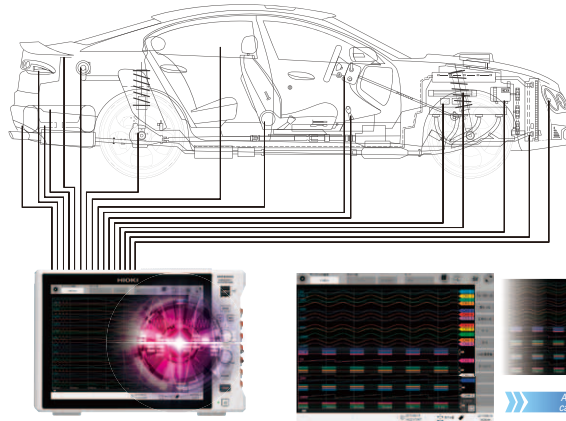

Test multiple points simultaneously

Continuous 32-channel logging at 1 MS/s for 1 hour

At the sampling rate of 1 MS/s, 32-channel logging can continue for 1 hour

MEMORY HiCORDER MR6000

Record ECU Signals

Due to the development of the electronic control units (ECU) in vehicles, automotive sensors are becoming more miniaturized, multifunctional and integrated. In order to carry out a full set of functional tests for vehicles, sensor signal logging is essential.

While multiple channels and high signal acquisition speed are required, the demands on measurement equipment are also increasing.

- Multiple channels for high-speed data transmission
- Isolation between channels
- Many types of sensors for a diverse range of applications
- A full line-up of measurement units

| Measured signal | Model | Description | No. of channels | Fastest sampling | Bandwidth | A/D resolution | DC accuracy | Max. input voltage | Sensitivity (#1) | Max. sensitivity range | Isolation | Supplement |
|--------------------------------|--------|------------------------|------------------|------------------|--|----------------|---|----------------------------|--------------------------------|------------------------|-----------|-------------------------------------|
| Voltage (high speed) | U8976 | High-Speed Analog Unit | 2 ch | 200 MS/s | DC to 30 MHz | 12 bits | ±0.5% f.s. | 400 V DC 1000 V DC (#2) | 0.0625 mV | 100 mV f.s. | Yes | n/a |
| Voltage | 8966 | Analog Unit | 2 ch | 20 MS/s | DC to 5 MHz | 12 bits | ±0.5% f.s. | 400 V DC | 0.05 mV | 100 mV f.s. | Yes | n/a |
| Voltage (4ch) | U8975 | 4ch Analog Unit | 4 ch | 5 MS/s | DC to 2 MHz | 16 bits | ±0.1% f.s. | 200 V DC | 0.125 mV | 4 V f.s. | Yes | n/a |
| Voltage (4ch, high resolution) | U8978 | 4ch Analog Unit | 4 ch | 5 MS/s | DC to 2 MHz | 16 bits | ±0.3% f.s. | 40 V DC | 3.125 μV | 100 mV f.s. | Yes | n/a |
| Voltage (high resolution) | 8968 | High Resolution Unit | 2 ch | 1 MS/s | DC to 100 kHz | 16 bits | ±0.3% f.s. | 400 V DC | 3.125 μV | 100 mV f.s. | Yes | with AAF |
| Voltage (DC, RMS) | 8972 | DC/RMS Unit | 2 ch | 1 MS/s | DC to 400 kHz | 12 bits | ±0.5% f.s. | 400 V DC | 0.05 mV | 100 mV f.s. | Yes | with RMS |
| Voltage (high voltage) | U8974 | High Voltage Unit | 2 ch | 1 MS/s | DC to 100 kHz | 16 bits | ±0.25% f.s. | 1000 V DC 700 V AC | 0.125 mV | 4 V f.s. | Yes | CAT IV 600 V AC/DC |
| Voltage (high resolution) | MR8990 | Digital Voltmeter Unit | 2 ch | 2 ms | n/a | 24 bits | ±0.01% rdg. ±0.0025% f.s. | 500 V DC | 0.1 μV | 100 mV f.s. | Yes | CAT II 300 V AC/DC |
| Current | U8977 | Current Unit | 3ch | 5 MS/s | DC to 2 MHz | 16 bits | ±0.3% f.s. | Current sensor only | Depends on current sensor | n/a | n/a | Max. 3 Units |
| Current | 8971 | Current Unit | 2 ch | 1 MS/s | DC to 100 kHz | 12 bits | ±0.65% f.s. | Current sensor only | Depends on current sensor | n/a | n/a | with RMS Max. 4 Units |
| Temperature | 8967 | Temperature Unit | 2 ch | 1.2 ms | DC | 16 bits | Detailed reference | Thermocouples only | 0.01°C | 200°C (392°F) f.s. | Yes | n/a |
| Strain | U8969 | Strain Unit | 2 ch | 200 kS/s | DC to 20 kHz | 16 bits | ±0.5% f.s. ±4 με | Strain only | 0.016 με | 4000 με f.s. | Yes | n/a |
| Frequency | 8970 | Frequency Unit | 2 ch | 200 kS/s | DC to 100 kHz (#5) | 16 bits | n/a | 400 V DC | 0.002 Hz | Depends on mode | Yes | n/a |
| Acceleration | U8979 | Charge Unit | 2 ch | 200 kS/s | DC to 50 kHz (DC) 1 Hz to 50 kHz (AC) | 16 bits | ±0.5% f.s. (Voltage) ±2.0% f.s. (Acceleration) | 40 V DC | Depends on acceleration sensor | n/a | Yes | Supports TEDS |
| Logic | 8973 | Logic Unit | 4 probes (16 ch) | n/a | n/a | n/a | n/a | n/a | n/a | n/a | n/a | Requires 9320-01, 9327 or MR9321-01 |

(#1) Minimum resolution shows the highest sensitivity resolution. (#2) When using the 9665 (#3) Minimum pulse width 2 μs

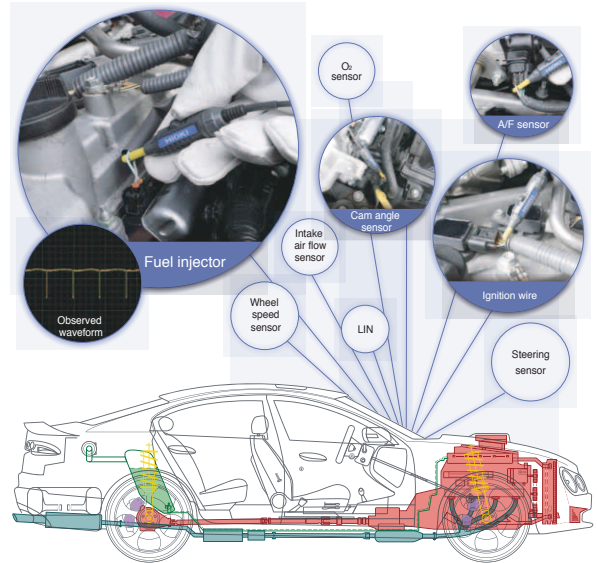

| Parameter | Units | Parameter (Cont'd) | Units |
|------------------------------|-----------|-----------------------------|--------|
| Battery Module Temperature 1 | °C | Motor 1 Speed | rpm |
| Battery Module Temperature 2 | °C | Motor 1 Torque | Nm |
| Battery Module Temperature 3 | °C | Motor Production Power | kW |
| Board Temperature | °C | Motor Regenerative Power | kW |
| Cabin Temperature | °C | Motor Temperature | °C |
| Dash Odometer | km | Outside Air Temperature | °C |
| Main Battery Current | Amp | Plug Status | 0 or 1 |
| Main Battery SOC | % | Vehicle Speed | km/h |
| Main Battery Voltage | Volt | Wheel Speed Front Driver | km/h |
| Input Voltage | millivolt | Wheel Speed Front Passenger | km/h |
| Inverter DC Voltage | Volt | Wheel Speed Rear Driver | km/h |
| Charging ? | 0 or 1 | Wheel Speed Rear Passenger | km/h |
| Charging DC ? | 0 or 1 | | |

Non-Contact CAN Sensor

Detect CAN FD/CAN signals by simply hooking the SP7001 over insulation of the wire.

Less plugging and unplugging of connectors reduces sensor faults caused by static electricity.

- Measure CAN signals without damaging the wiring insulation
- Data transfer speeds:
CAN FD: 125kbit/s to 3Mbit/s
CAN: 125kbit/s to 1Mbit/s
- Wire diameter: φ1.2mm to 2.0mm (standard size of in-vehicle signal cables)



NON-CONTACT CAN SENSOR SP7001



SP7001

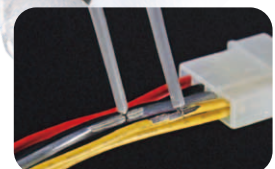

Conventional method

Automotive Electronics

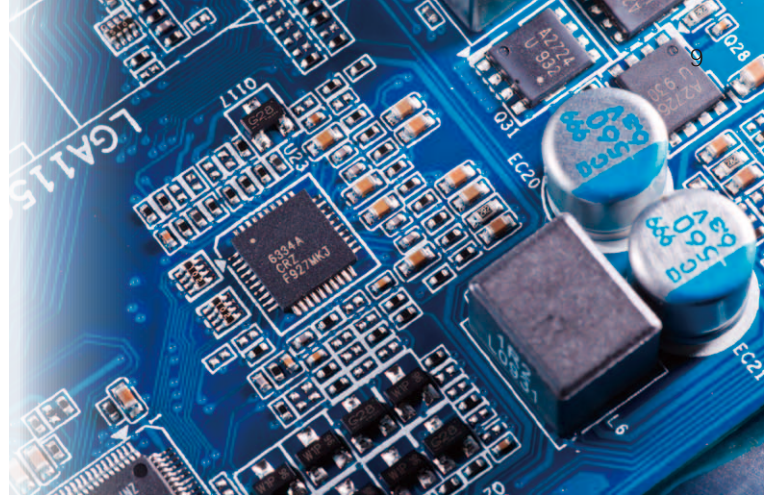

Test Electrical Characteristics of Auto Parts

In next generation vehicles, the types and number electronic parts continue to increase. To design vehicles with advanced functions, electronic components and parts must be tested in the R&D stage.

Test Component Integrity

Select the instrument according to your application's frequency range.

- High-precision testing
- A wide variety of test fixtures



IMPEDANCE ANALYZER IM7585

LCR METER IM3536

Three-Component Mode

| | | | | | |
|---|--|---|---|--|---|
| A | | Coils with large loss and small ESR | C | | Capacitors highly susceptible to the influence of leakage resistance Resistors high in resistance values and highly susceptible to the influence of float capacity |
| B | | Coils with high ESR Resistors low in resistance values and highly susceptible to the influence of wiring induction | D | | Common capacitors |

Four-Component Mode

| | | |
|---|--|--------------------------|
| E | | Piezoelectric components |
|---|--|--------------------------|

Parameter chart of four-component mode

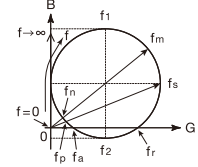

Test Parameters (Four-component mode)

- L1 (inductance)
- C1 (capacitance)
- R1 (resistance)
- C0 (parallel capacitance)
- Qm (mechanical resonance m-quality factor, mechanical quality m-coefficient)
- fr (resonance frequency)
- fa (anti-resonance frequency)
- fs (series resonance frequency)
- fp (parallel resonance frequency)
- fm (maximum admittance frequency)
- fn (minimum admittance frequency)
- f1 (maximum susceptance frequency)
- f2 (minimum susceptance frequency)

Test Parameters (Three-component mode)

- L1 (inductance)
- C1 (capacitance)
- R1 (resistance)
- Qm (quality factor)
- fr (resonance frequency)
- fa (anti-resonance frequency)

Test In-Vehicle Printed Circuit Boards

Due to the proliferation of electric vehicles and increased use of electrical parts within vehicles, the variety and actual number of circuit boards are ever-increasing. More than ever, there is a need for highly reliable inspection of a wide range of PCBs (FPC, semiconductor substrates) and electronic devices in response to the increased use of in-vehicle mounted boards in ECU and BMS.

Test Mounted Boards Built for Automobiles

- Improve mounted board quality
- Provide verification of proper mounting via electrical test data



IN-CIRCUIT TESTER
FA1220 series



FLYING PROBE TESTER
FA1240

Test Bare Boards Built for Automobiles

- Detect latent defects in high density printed circuit boards

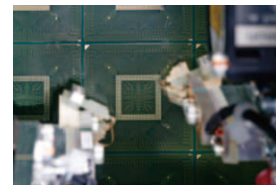

FLYING PROBE TESTER
FA1817

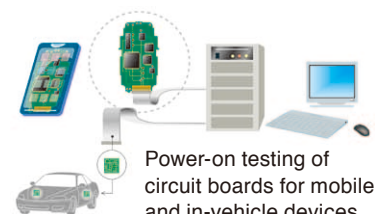

Power-on testing of circuit boards for mobile and in-vehicle devices



Detect insulation failure

High speed insulation testing of relatively low voltages and ultra high resistance (e.g., 250 V @ 100 GΩ)

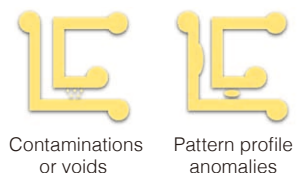

Contaminations or voids

Pattern profile anomalies

Maintenance

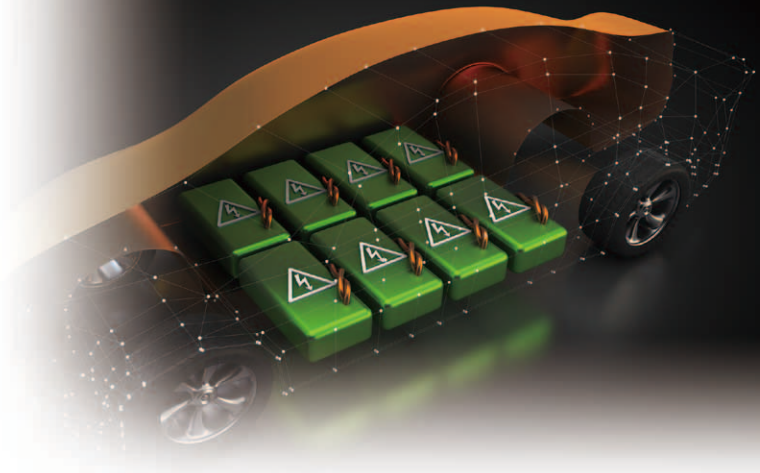

Essential Tools for On-site Maintenance

In terms of maintenance, alternative energy vehicles have needs that are different from those of conventional automobiles. To meet increased electrification and power system changes, even more inspections must be conducted during auto maintenance and repair in order to ensure driving safety.

Inspect high voltage wire harnesses

After operating a vehicle over a long period of time, continuity and insulation problems may appear in high-voltage wire harnesses. The performance of the harnesses determines whether the vehicle can function normally, and directly affects the safety of the vehicle, passengers and driver. To inspect a harness, it must be unplugged from the power source before it can be measured by a multimeter. The harness can be deemed compliant if the results fall within the accepted range as determined by your standards.

- Designed to prevent connection errors
- 5-digit display (up to 60,000) and high-resolution measurement

Terminal Shutters Prevent Incorrect Insertion of Leads



For Current Range: The A and COM connectors open
For Voltage Range: The V and COM connectors open

The terminal shutters of functions, when not in use, will close by design (DT4281/4282).



DIGITAL MULTIMETER DT4281

Insulation Resistance Testing of Automotive Motors

Insulation resistance testing is absolutely essential to ensure the safety of automotive motors.

- Voltage range: 500 to 1000 V (IR4057)
- Easy to operate



INSULATION TESTER IR4057



HIGH VOLTAGE INSULATION TESTER IR3455

Test Battery Deterioration State

Quickly determine the deterioration level of batteries.

- Portable and compact
- Directly upload test data to your mobile device via Bluetooth®



BATTERY HiTESTER BT3554



GENNECT Cross Data Transfer and Management App

Wireless Power Transmission Evaluation System

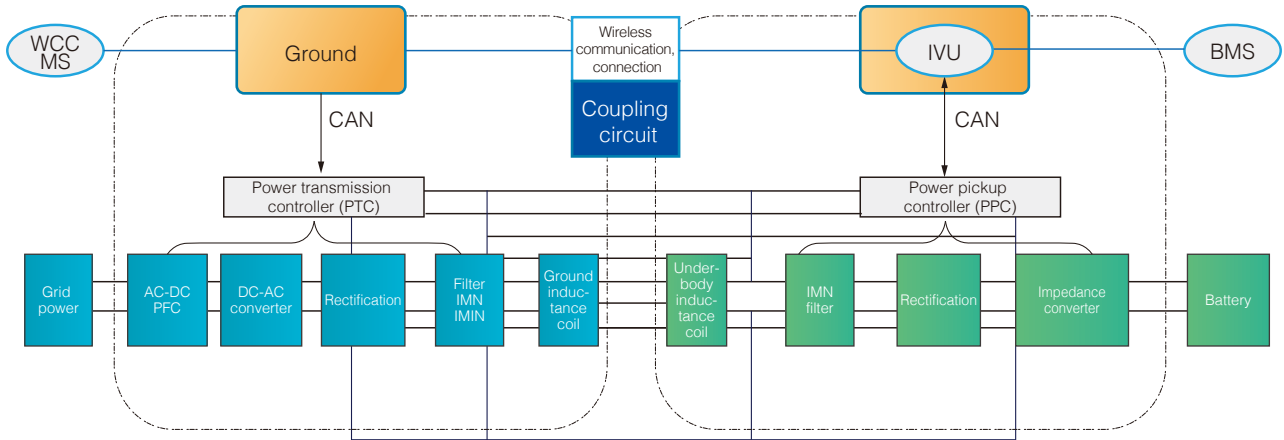

Fully Automated WPT Evaluation Testing

Integrated measurement and an XYZ stage delivers high-speed analysis of various multi-point measurements.

- Generate 4 separate characteristic graphs in real time
- Automatically control the position of the power transmission coil (max. 800 mm)
- Two types of transmission efficiency measurements plus simultaneous testing of the surrounding conditions

| Category | Evaluation parameter | Test |
|---|---|---|
| Bench/ frame type test | System efficiency | Power class, operating frequency voltage/current, and power transmission efficiency |
| | Electromagnetic field limits | Magnetic coupling (coupling coefficient, mutual inductance) and resonance |
| | Ground clearance | |
| | Safety class --- human body electromagnetic field | Electromagnetic field required in ICNIRP guidelines |
| Expandable functions (grounded equipment) | Safety class --- foreign substance, inflammation | Temperature testing |
| | Safety | Touch current, dielectric and compression strength, and contact resistance |



Automatic position control of power transmission coil (max. 800 mm)

Fastest speed: 3000 points/h
Long stroke design
X, Y ±300mm
Z ±100mm

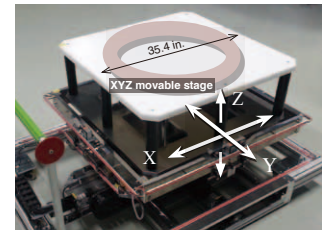

WPT EVALUATION STAGE Z5016

Auto-generation of 4 graphs even during testing



PC SUITE Z5015

Two types of transmission efficiency measurement

Simultaneous measurement of the surrounding conditions



- **Power transmission efficiency measurement**
Detailed analysis by performing actual power transmission
- **Automatic measurement of coupling coefficient**
Calculate efficiency without applying a high voltage
- **Data logging**
Measure environmental characteristics such as voltage, heat, and magnetic flux density

PLC RACK Z5017, SWITCHING BOX Z5018

ISO/IEC 17025 Calibration (JCSS)

HIOKI is an international MRA-compliant, JCSS-accredited calibration service provider that meets ISO/IEC 17025 requirements. This enables us to issue JCSS calibration certificates bearing the international MRA-compliant JCSS mark that are recognized worldwide.

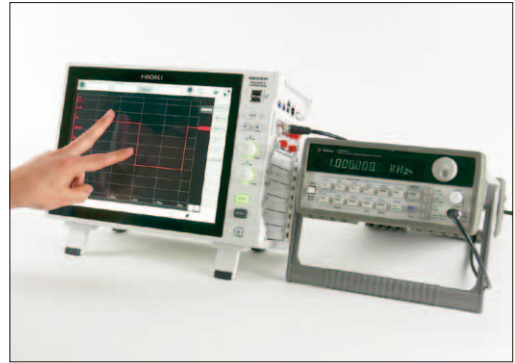

JCSS calibration and international MRAs

NITE (National Institute of Technology and Evaluation)

IA Japan (International Accreditation Japan)

JCSS
(Japan Calibration Service System)
International MRA
(mutual recognition agreement)

Accreditation
and
registration

Calibration
service
providers



Calibration certificates that
are recognized worldwide



This is the mark of the calibration service provider registration program based on the Measurement Act. JCSS-registered service providers are registered under the ISO/IEC 17025 standard. HIOKI E.E. CORPORATION is an international MRA-compliant, JCSS-accredited service provider. HIOKI's accreditation number is JCSS 0156.

JCSS is a registration program designed to ensure that calibration service providers possess the technological skills needed to perform calibration that complies with measurement-related laws and the requirements imposed by ISO/IEC 17025. Registered service providers are entitled to perform JCSS calibration and issue calibration certificates bearing the JCSS mark. Such certificates serve as evidence of the calibration service provider's technological skills and traceability. JCSS calibration service providers who have been certified as international MRA-compliant can issue calibration certificates bearing the ILAC-MRA and IA Japan marks. Such certificates can be used as official documents whose validity is recognized worldwide.

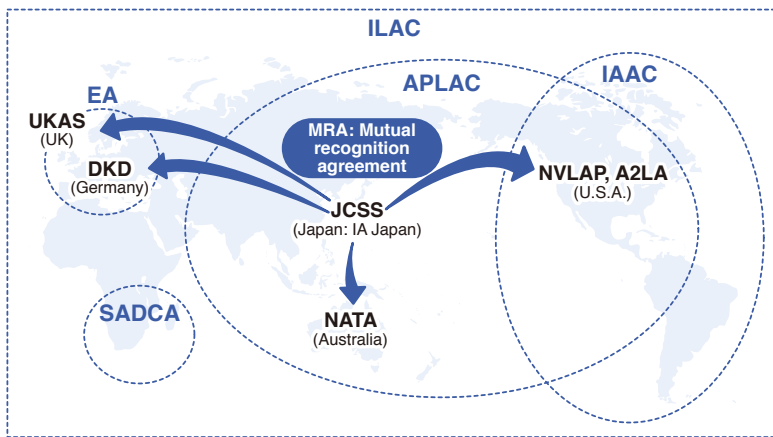

ILAC: International Laboratory Accreditation Cooperation / **APLAC:** Asia Pacific Laboratory Accreditation Cooperation / **IAAC:** Interamerican Accreditation Cooperation / **EA:** European Cooperation for Accreditation / **SADCA:** Southern African Development Community Accreditation

International MRAs

An MRA is a mutual recognition agreement. IA Japan belongs to ILAC and APLAC. Calibration certificates issued by calibration service providers that have been certified as MRA-compliant by IA Japan are treated as equivalent to calibration certificates recognized by member certification entities in member countries.

Note: Company names and product names appearing in this catalog are trademarks or registered trademarks of various companies.

HIOKI
HIOKI E. E. CORPORATION

DISTRIBUTED BY

HEADQUARTERS

81 Koizumi,
Ueda, Nagano 386-1192 Japan
<https://www.hioki.com/>



Scan for all
regional contact
information