

StanleyBlack&Decker

STANLEY[™]

PERFORMANCE IN ACTION.[™]



**ONE TOOL
COMPANY**

2018

HAND TOOLS



TOOLS THAT BUILD THE WORLD

Since 1843, STANLEY® has been proudly offering quality and innovative tool solutions. For over a century, we have built a legacy by producing some of the most well known hand tools and storage products in the world, all to help you build a legacy of your own.

We are committed to bringing you durable and quality tools that are inventive and distinct. With superior quality, constant innovation and rigorous operational improvements, STANLEY® defines excellence and is trusted by professionals around the globe.

In 2013, STANLEY® embraced a new brand logo and identity, modernizing one of the most recognizable brands in the world. The new brand identity exemplifies

STANLEY's 175-year reputation for innovation, merit and performance. With the evolution of the brand logo, we are proud to offer you even more cutting edge products for all your job site needs. It is time to experience the power of innovation!



STANLEY™

1843

The Stanleyworks, originally a bolt and door hardware manufacturing company located in New Britain, Connecticut; was founded in 1843 by Frederick T. Stanley



1863
STANLEY introduced hammers

1876
Miter boxes were introduced



1921
A new logo is introduced to symbolize the merger of the STANLEY Rule & Level Company and the STANLEY Works

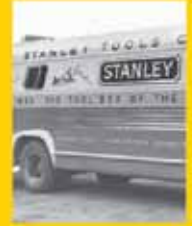

1940
STANLEY's fleet of Rollorama coaches carried more than 1,300 sample items to retailers



1844
Began to manufacture ivory and boxwood rules

1870
STANLEY began manufacturing screwdrivers and hand planes



1857
STANLEY Rule & Level Company established by Henry Stanley begins to manufacture levels



1900
Rules & Level is the largest manufacturer of planes and related tools in the world

1924
STANLEY filed a patent for the ratcheting screwdriver

1920
The STANLEY Rule and Level Company merged with The Stanley Works to become it's famous Hand Tools Division



1930
STANLEY made the first steel tape rule



1937
Henry Phillips, inventor of Phillips head screw choose STANLEY as the first company to begin making Phillips screwdrivers

1921
STANLEY manufactured it's first utility knife



1954

Time Magazine published a cover story titled "Do-It-Yourself-The New Million Dollar Hobby". STANLEY was ideally positioned to benefit from this trend and quickly developed products for this new market



1969

The Power Lock Tape Rule represented STANLEY as a part of Apollo 11's Lunar Landing Gear

1980

The Stanleyworks was presented the American Eagle Award from the American Supply & Machinery Manufactures 'Associ.Inc.' for its "unusual across-the-board quality"



2006

STANLEY acquires Facom® industrial hand and 1980 mechanics tools.



STANLEY

2013

STANLEY launches new logo

2015

STANLEY launches automotive line & white series short meter

1963

STANLEY opens the largest hand tool plant in the world in New Britain, CT. The same year the Power Lock Tape Rule was introduced



1998

STANLEY goes into plastic storage business, including tool boxes



1970

STANLEY began producing manual staplers

2011

STANLEY launches Carbide blades



2008

STANLEY re-introduces Sweetheart planes



2014

The STANLEY 19" Metal Toolbox Wins a Good Design Award for 2014



2015

STANLEY launches STANLEY branded power tools & accessory lines

1999

Stanley launches the FatMax Tape Rule and the FatMax Anti Vibe Hammer



2017

IRWIN Tools



ACHIEVING UNPARALLELED PERFORMANCE WITH STANLEY® TOOLS

A BRAND YOU CAN TRUST

For over a century, we have built a legacy by producing some of the most well known hand tools and storage products in the world, all to help you build a legacy of your own. It is this rich history of innovation that has made STANLEY® a trusted name and industry pioneer.

In 1843, STANLEY® started to manufacture bolts, hinges, and other hardware by using wrought iron. By merging superior quality materials, constant innovation, and rigorous operational improvements, STANLEY® defined excellence and till today, is trusted by professionals on job sites around the globe.



FULL RANGE OF PRODUCTS FOR ALL PROFESSIONALS

Be it construction or mechanic tools, we have got you covered. STANLEY® provides a broad range of over 2,000 products in all tool categories. No matter what car you drive, what stores you shop at, or what building you work in, you can bet that we deliver the tools and solutions that you can count on, and you can be sure that we will keep making it better.

QUALITY THAT EXCEEDS STANDARDS

Most of the products produced by STANLEY® exceed government and industry standards such as ASME/ANSI, ISO and DIN. We push ourselves every day to deliver tough, strong, and reliable hand tools. We have state-of-the-art test facilities that cover solvent resistance and drop testing to ensure that our products meet critical standards. In each product category, we also perform specific performance and life tests to ensure product durability and quality.



Hardness Test



Corrosion &
Solvent Test



Drop Test



Proof Torque

STANLEY® PROVIDES NOT ONLY TOOLS THAT HELP YOU GET THE JOB DONE, BUT ALSO HELP YOU TO GET IT DONE RIGHT.

INNOVATIVE DESIGN WITH GREAT FUNCTIONALITY

STANLEY® designs tools based on end user research and user insights. Our innovative processes are fashioned to determine what users want even before they know it. The brand new range of STANLEY® tools meet the demanding nature of all professionals within construction, renovation and automotive sectors. We are the pioneers in many hand tool categories and

have created several patented features focused on solving problems faced by users. We have dedicated product design practices that tap into professional needs to conceptualize products that offer the best user benefits. From the field straight to the design team, we strive to offer valuable benefits to all professionals.



MANUFACTURING

STANLEY® has been managing and manufacturing tools for over a century. The company has built a brand synonymous with quality and assurance. Facilities located all over the world meticulously churn out quality tools to meet the ceaseless demands of our clients. Our best-in-class manufacturing process ensures that the final product is something to be proud of.

STANLEY® GLOBAL PRESENCE

● 20+ Global manufacturing sites and labs with similar process and quality controls for consistent quality.

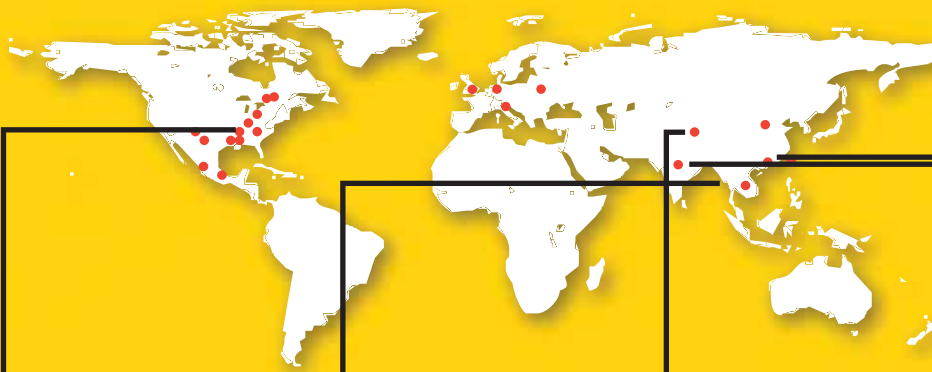

USA



THAILAND



CHINA



TAIWAN



INDIA



CONTENTS

SPANNERS & SETS

01-07



DOUBLE OPEN END SPANNERS

RING & COMBINATION SPANNERS/SETS

OPEN/RING END SLOGGING SPANNERS

ADJUSTABLE WRENCHES/SPANNERS

FASTENING TOOLS

08-25



CUSHION GRIP SCREWDRIVERS/ SETS

VDE, TRADITIONAL GRIP SCREWDRIVERS/ SETS

TORX/HEX/T-HANDLE KEYS, SPECIALTY SCREWDRIVERS

SOLDERING IRON, RIVETERS

SOCKETS & ACCESSORIES

26-41



1/4, 3/8, 1/2 & 3/4 DRIVE SOCKETS

1/4, 3/8, 1/2 & 3/4 RATCHETS & ACCESSORIES

T-HANDLE SOCKETS & 1/2 IMPACT TOOLS

TOOL SETS

42-49



MECHANICS TOOLS

SPECIALITY TOOLS SETS

TORQUE WRENCHES

50-57



BRITTOOL 3/8, 1/2, 3/4 & 1 SQUARE DRIVE

STANLEY RATCHETING TYPE 1/4, 3/8, 1/2, 3/4

CONTENTS

PLIERS

58-70



PLIERS

LOCKING PLIERS

VDE

PIPE TOOLS

71-77



CI PIPE WRENCH, STILLSON PIPE WRENCH

WATER PUMP PLIER, TUBING CUTTER

CUTTING TOOLS

78-90



RETRACTABLE UTILITY KNIFE & BLADES

SNAP-OFF KNIFE & BLADES

HACKSAWS, BOLT CUTTERS & SNIPS

MEASURING & LAYOUT TOOLS 91-96



MEASURING TAPE & MEASURING WHEELS

TORPEDO, BOX, I-BEAM LEVELS

CHALK LINE REEL & REFILL

COMBINATION SQUARES

WORK HOLDING

97-105



CLAMPS

TRADITIONAL CLAMPS

VICES

HAMMERS, CHISELS & PUNCHES

106-114



HAMMERS

HANDSAWS

CHISELS & PUNCHES

SPECIALITY TOOLS

115-119



3 JAW PULLERS

FEELER GAUGE, OIL FILTER WRENCH

12-IN-1 MULTI TOOL, SCREW EXTRACTOR

BOTTLE JACKS

TOOL STORAGE

120-127



METAL STORAGE

PLASTIC TOOL BOX

NYLON TOOL BAG

STANLEY®

SPANNERS & SETS



**DOUBLE OPEN END SPANNERS
RING & COMBINATION SPANNERS/SETS
OPEN/RING END SLOGGING SPANNERS
ADJUSTABLE WRENCHES/SPANNERS**

SPANNERS



A PROFESSIONAL CHOICE FOR EVERY TASK

A core range suitable for all end users. One of the most commonly used hand tools in automotive trades and essential to all mechanics technicians, mechanics patterns and formats carefully selected in extended selling lines. Fully certified with ISO and ANSI standards, the range

performs outstandingly and their innovative design offers ergonomic and comfort, while the high quality standards of finished forged steel gives them longer life and rust resistance.



ANTI-SLIP WRENCH
Profiled jaw ensures secure location of nut or bolt head



MAXI-DRIVE™
Profiled ring grips nut or bolt head securely for maximum torque

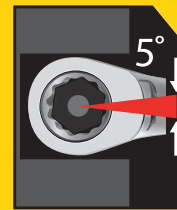

5° RATCHET INCREMENTS
For faster driving in restricted spaces



ANSI
American National Standards Institute



ISO
Accreditation by independent organization made up of members from the national standards bodies of 164 countries.



DIN
Accredited standards carried out by the German Institute for Standardization

SPANNER RANGE OVERVIEW

Double Open End Spanner



Combination Spanner



Shallow Offset Ring End Spanner



Adjustable Spanner



Combination Reversible Ratcheting Wrench



Slogging Spanner



DOUBLE OPEN END SPANNERS - MATTE FINISH

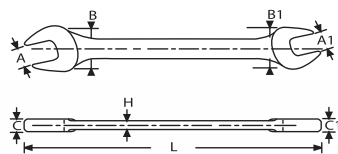

- IS 2028
- Anti-slip design on open end
- Chrome vanadium steel
- Matt finishing

PART No.	DESCRIPTION	SIZE	A(mm)	L(mm)	B(mm)	B1(mm)	C(mm)	C1(mm)	WT.(KG)	PBQ
70-366E	Double Open End Spanner	6x7mm	6	96.5	15.5	17.5	2.5	3.5	0.015	10
70-367E	Double Open End Spanner	8x9mm	8	106.5	19	20.5	3	4	0.021	10
70-368E	Double Open End Spanner	10x11mm	10	123	22	24	4	5	0.029	10
70-369E	Double Open End Spanner	12x13mm	12	143	25.5	27.5	4.5	5.5	0.043	10
70-370E	Double Open End Spanner	14x15mm	14	152.5	29.5	32	5	6	0.065	10
70-371E	Double Open End Spanner	16x17mm	16	164.5	34	36	5.4	6.4	0.084	10
70-372E	Double Open End Spanner	18x19mm	18	178	37.5	39.5	5.5	7.5	0.109	10
70-373E	Double Open End Spanner	20x22mm	20	197	41.5	45.5	6	8	0.152	10
70-374E	Double Open End Spanner	21x23mm	21	218.5	43.5	47.5	6.5	8.5	0.166	10
70-375E	Double Open End Spanner	24x27mm	24	237	49.5	54	7	9	0.232	10
70-376E	Double Open End Spanner	25x28mm	25	248.5	51.5	57.5	7.5	9.5	0.290	10
70-377E	Double Open End Spanner	30x32mm	30	262	61	65	8.5	10.5	0.349	10
72-060	Double Open End Spanner	32x36mm	-	-	-	-	-	-	-	5
72-061	Double Open End Spanner	34x36mm	-	-	-	-	-	-	-	5
72-062	Double Open End Spanner	36x41mm	-	-	-	-	-	-	-	5
72-063	Double Open End Spanner	41x46mm	-	-	-	-	-	-	-	5
72-064	Double Open End Spanner	46x50mm	-	-	-	-	-	-	-	2
72-065	Double Open End Spanner	50x55mm	-	-	-	-	-	-	-	2
72-066	Double Open End Spanner	55x60mm	-	-	-	-	-	-	-	2



COMBINATION SPANNERS - MATTE FINISH



- IS 6131-1980
- Anti-slip design on open end
- Maxi-Drive™ system helps reduce fastener rounding
- Chrome vanadium steel
- Matt finishing

PART No.	DESCRIPTION	SIZE	A(MM)	L(MM)	B(MM)	B1(MM)	C(MM)	C1(MM)	WT.(KG)	PBQ
70-936E	Combination Spanner	6mm	6	100	15	10.2	3.6	5.4	0.015	10
70-937E	Combination Spanner	7mm	7	110	16	11.7	3.6	5.4	0.019	10
70-938E	Combination Spanner	8mm	8	120	18	13	4.1	6.4	0.025	10
70-939E	Combination Spanner	9mm	9	130	20	14.5	4.1	6.4	0.031	10
70-940E	Combination Spanner	10mm	10	140	22	15.8	4.6	7.9	0.039	10
70-941E	Combination Spanner	11mm	11	150	24.5	17.2	5.1	8.4	0.049	10
70-942E	Combination Spanner	12mm	12	160	27.5	18.5	5.1	8.4	0.058	10
70-943E	Combination Spanner	13mm	13	170	28.5	20	5.9	9.4	0.070	10
70-944E	Combination Spanner	14mm	14	180	30.5	21.5	5.9	9.9	0.088	10
70-945E	Combination Spanner	15mm	16	200	34.5	24	6.3	10.9	0.113	10
70-946E	Combination Spanner	16mm	17	210	37.5	25.5	6.5	10.9	0.128	10
70-947E	Combination Spanner	17mm	18	220	39.5	26.5	6.7	11.9	0.150	10
70-948E	Combination Spanner	18mm	19	230	42	28	7.2	11.9	0.171	10
70-949E	Combination Spanner	19mm	19	230	42	28	7.2	11.9	0.171	10
70-950E	Combination Spanner	20mm	20	240	43	29.5	7.7	12.4	0.210	10
70-951E	Combination Spanner	21mm	21	250	45	31.5	8.2	12.9	0.214	10
70-952E	Combination Spanner	22mm	22	260	47	33	8.7	12.9	0.233	10
70-953E	Combination Spanner	23mm	23	270	49	34	8.9	13.4	0.260	5
70-954E	Combination Spanner	24mm	24	280	51	36	8.9	13.9	0.290	5
70-955E	Combination Spanner	25mm	25	290	53.5	37	9.2	14.4	0.329	5
70-956E	Combination Spanner	26mm	26	300	55.2	38	9.4	15	0.215	5
70-957E	Combination Spanner	27mm	27	310	57.5	39.5	9.7	15.4	0.282	5
70-960E	Combination Spanner	30mm	30	340	60.5	43.5	10.2	16.4	0.495	5
70-961E	Combination Spanner	32mm	32	360	65.5	46.5	10.2	16.9	0.562	5



“ I BELIEVE THAT WITH THE RIGHT TOOLS, ANYTHING IS POSSIBLE. STANLEY'S WIDE VARIETY OF PRODUCTS HAS ENABLED ME TO PROVE NOT JUST TO THE WORLD, BUT TO MYSELF WHAT I CAN ACCOMPLISH ”

OFFSET RING END SPANNERS - MATTE FINISH

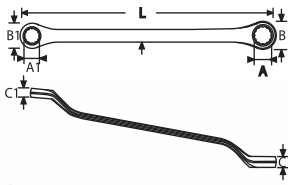

- IS 2029
- Anti-slip design on open end
- Maxi-Drive™ system helps reduce fastener rounding
- Chrome vanadium steel
- Matt finishing

PART No.	DESCRIPTION	SIZE	L(mm)	A(mm)	A1(mm)	B(mm)	B1(mm)	PBQ
70-381E	Offset Ring Spanner	6x7mm	180	5.0	6.0	9.0	10.5	10
70-382E	Offset Ring Spanner	8x9mm	195	6.0	7.0	12.0	13.5	10
70-383E	Offset Ring Spanner	10x11mm	205	8.0	9.0	14.5	16.0	10
70-384E	Offset Ring Spanner	12x13mm	225	9.0	10.0	17.5	19.0	10
70-385E	Offset Ring Spanner	14x15mm	235	10.0	11.0	20.5	21.5	10
70-386E	Offset Ring Spanner	16x17mm	255	11.0	12.0	23.5	24.5	10
70-387E	Offset Ring Spanner	18x19mm	275	12.0	13.0	26.5	27.5	10
70-388E	Offset Ring Spanner	20x22mm	300	12.5	13.5	28.5	31.5	5
70-389E	Offset Ring Spanner	21x23mm	315	12.5	13.5	29.5	33.5	5
70-390E	Offset Ring Spanner	24x27mm	340	13.5	14.5	34.5	38.5	5
70-391E	Offset Ring Spanner	25x28mm	350	13.5	14.5	36.5	40.5	5
70-392E	Offset Ring Spanner	30x32mm	365	15.5	17.5	42.5	44.5	5
72-067	Deep Offset Ring Spanner	32x36mm	406	17.5	18.5	46	50.5	5
72-068	Deep Offset Ring Spanner	36x41mm	436	18.5	20	50.5	58.5	5
72-069	Deep Offset Ring Spanner	41x46mm	471	20.5	22	58.5	65.5	5
72-070	Deep Offset Ring Spanner	46x50mm	511.0	22.0	23.5	65.5	71.5	2
72-071	Deep Offset Ring Spanner	50x55mm	556.0	23.5	25.2	71.5	78.5	2
72-072	Deep Offset Ring Spanner	55x60mm	605.0	25.2	27.2	78.5	86.5	2



ADJUSTABLE SPANNER - SOFTGRIP

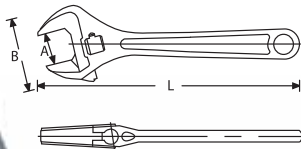

- Soft grip for anti-slip & comfort
- Jaws fully hardened & tempered
- 25% more torque
- For holding on fastening nuts & bolts
- Rust resistant finish

PART No.	DESCRIPTION	SIZE	PBQ
87-796-23	Hd Adjustable Spanner	450mm-18	1



ADJUSTABLE SPANNER - CHROME PLATED

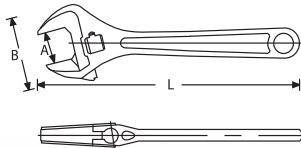

- ASME B107.100, ASME B107.8
- Adjustable jaw design allows tool to grip many fastener sizes
- Knurl adjusting mechanism for quick and precise adjustments
- Built-in tension spring stabilizes movable jaw
- Polished chrome head and chrome-plated body for anti-corrosion protection
- Laser-etched SAE and mm jaw scale for easy size adjustment
- Lightweight handle design

PART No.	DESCRIPTION	SIZE	A(MM)	L(MM)	B(MM)	WT.(KG)	PBQ
1-87-430	Adjustable Spanner	100mm	13	100mm / 4"	31	-	6
STMT87431-8	Adjustable Spanner	150mm	19.3	150mm / 6"	44.5	0.14	6
STMT87432-8	Adjustable Spanner	200mm	24	200mm / 8"	55.5	0.28	6
STMT87433-8	Adjustable Spanner	250mm	30	250mm / 10"	68.5	0.41	6
STMT87434-8	Adjustable Spanner	300mm	36	300mm / 12"	82	0.71	6
STMT87435-8	Adjustable Spanner	375mm	46	375mm / 15"	103	1.42	4



ADJUSTABLE SPANNERS - PHOSPHATE FINISH

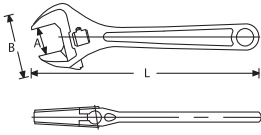

- IS 6149 -1948
- Cr-V steel
- Phosphate finish
- Knurl adjusting mechanism for quick and precise adjustment
- Built-in tension spring stabilizes movable jaw
- Forged chrome vanadium steel is strong and durable
- Laser-etched mm jaw scale for easy size adjustment
- Lightweight handle design

PART No.	DESCRIPTION	SIZE	A(MM)	L(MM)	B(MM)	WT.(KG)	PBQ
STMT74893-8	Adjustable Spanner	150mm	18	150mm / 6"	45	0.130	5
STMT74894-8	Adjustable Spanner	200mm	24	200mm / 8"	58	0.256	5
STMT74895-8	Adjustable Spanner	250mm	27	250mm / 10"	65	0.498	5
STMT74896-8	Adjustable Spanner	300mm	34	300mm / 12"	80	0.820	5



COMBINATION REVERSIBLE RATCHETING SPANNERS

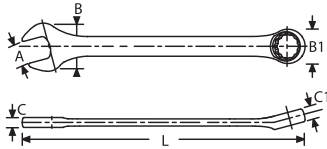

- ISO 1711-1, ISO 691, DIN 3113
- Maxi-Drive™ system helps reduce fastener rounding
- 5° increment
- Chrome vanadium steel
- Full polished finishing

PART No.	DESCRIPTION	SIZE	JAW(MM)	L(MM)	B(MM)	B1(MM)	C(MM)	C1(MM)	WT(KG)	PBQ
STMT89934-8B-12	Ratcheting Spanner	8mm	8	111.6	19.4	16.8	19.4	7	0.028	10
STMT89935-8B-12	Ratcheting Spanner	9mm	9	123.6	20.7	19	20.6	7.3	0.04	10
STMT89936-8B-12	Ratcheting Spanner	10mm	10	131.2	21.9	20	21.7	7.8	0.048	10
STMT80012-8B-12	Ratcheting Spanner	11mm	11	148.2	24.2	20.8	24.3	8.2	0.062	10
STMT89937-8B-12	Ratcheting Spanner	12mm	12	155.2	25.7	23	25.4	8.7	0.080	10
STMT89938-8B-12	Ratcheting Spanner	13mm	13	162.5	27.2	25	27.2	9	0.086	10
STMT89939-8B-12	Ratcheting Spanner	14mm	14	182.4	30.8	27	30.7	9.5	0.120	10
STMT89940-8B-12	Ratcheting Spanner	15mm	15	192.2	32.2	28	32.1	9.9	0.134	10
STMT89941-8B-12	Ratcheting Spanner	16mm	16	202.2	34	30	33.8	10.4	0.150	10
STMT89942-8B-12	Ratcheting Spanner	17mm	17	222.5	37.7	31.7	37.5	10.8	0.180	10
STMT89943-8B-12	Ratcheting Spanner	18mm	18	234.1	39.1	32.9	39.3	11.2	0.200	10
STMT89944-8B-12	Ratcheting Spanner	19mm	19	246.1	41.3	34	40.5	11.6	0.222	10



OPEN END SLOGGING SPANNERS

- DIN 133
- Cr-V forging, durable
- European most popular design



PART No.	DESCRIPTION	SIZE	PBQ
96-936-23	Open End Slogging Spanner	30mm	1
96-938-23	Open End Slogging Spanner	32mm	2
96-939-23	Open End Slogging Spanner	36mm	1
96-940-23	Open End Slogging Spanner	41mm	1
96-941-23	Open End Slogging Spanner	46mm	1
96-950-23	Open End Slogging Spanner	50mm	1
96-951	Open End Slogging Spanner	55mm	1
96-952	Open End Slogging Spanner	60mm	1
96-953	Open End Slogging Spanner	65mm	1
96-954-23	Open End Slogging Spanner	70mm	1

RING END SLOGGING SPANNERS

- DIN 7444
- Cr-V forging, durable
- European most popular design



PART No.	DESCRIPTION	SIZE	PBQ
71-682	Ring End Slogging Spanner	24mm	1
96-911	Ring End Slogging Spanner	27mm	1
96-913	Ring End Slogging Spanner	30mm	1
96-914	Ring End Slogging Spanner	32mm	1
96-915	Ring End Slogging Spanner	36mm	1
96-917	Ring End Slogging Spanner	41mm	1
96-918	Ring End Slogging Spanner	46mm	1
96-919	Ring End Slogging Spanner	50mm	1
96-920	Ring End Slogging Spanner	55mm	1
96-921	Ring End Slogging Spanner	60mm	1
96-922	Ring End Slogging Spanner	65mm	1
96-923	Ring End Slogging Spanner	70mm	1
96-924	Ring End Slogging Spanner	75mm	1

DOUBLE OPEN END SPANNER SET - MATTE FINISH

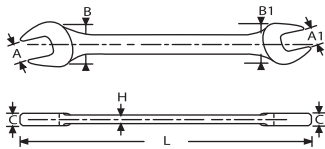

- Anti-slip design on open end
- Chrome vanadium steel
- Matt finishing

PART No.	DESCRIPTION	SIZE	PBQ
70-379E	8 Pc Double Open End Spanner Set	6x7, 8x9, 10x11, 12x13, 14x15, 16x17, 18x19, 20x22mm	1
70-380E	12 Pc Double Open End Spanner Set	6x7, 8x9, 10x11, 12x13, 14x15, 16x17, 18x19, 20x22, 21x23, 24x27, 25x28, 30x32mm	1



DOUBLE OPEN END SLIMLINE SPANNER SET

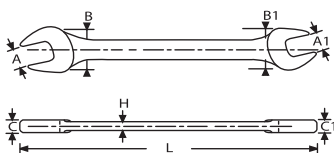

- DIN 3133 B, DIN 17350, ISO 1758
- Anti-slip design on open end
- Chrome vanadium steel

PART No.	DESCRIPTION	SIZE	PBQ
1-87-718	8 Pc Slimline Double Open End Wrench Set, Met	6x7, 8x9, 10x11, 12x13, 14x15, 16x17, 18x19, 20x22mm	1
1-87-712	7 Pc Double Open End Wrench Set, Imp	1/4 x 5/16, 3/8 x 7/16, 1/2 x 9/16, 9/16 x 5/8, 11/16 x 3/4, 13/16 x 7/8, 15/16 x 1	1



COMBINATION SPANNERS SETS

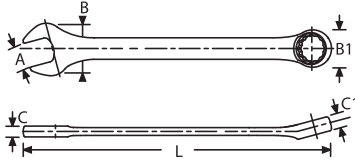

- Anti-slip design on open end
- Maxi-Drive™ system helps reduce fastener rounding
- Chrome vanadium steel
- Matt finishing

PART No.	DESCRIPTION	SIZE	PBQ
70-963E	8 Pc - Combination Spanners Sets	8,9,10,11,13,14,17 & 19MM	1
70-964E	12 Pc - Combination Spanners Sets	6,7,8,9,10,12,13,14,17,19, & 22MM	1
70-965E	23 Pc - Combination Spanners Sets	6,7,8,9,10,12,13,14,15,16,17,18,19,20,21,22,23,24,25, 27,30,& 32MM	1



14PC COMBINATION SLIMLINE SPANNERS SET

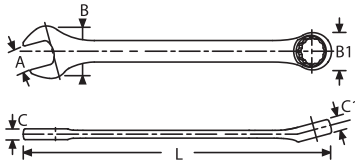

- Anti-slip design on open end
- Maxi-Drive™ system helps reduce fastener rounding

PART No.	DESCRIPTION	SIZE	WT.(g)	PBQ
1-87-038	14 Pc Slimline Combination Spanner Set - Metric	10-32MM	2300	1
1-87-709	14 Pc Slimline Comb Wrench Set - Imperial	3/8 - 1 1/4	10400	1

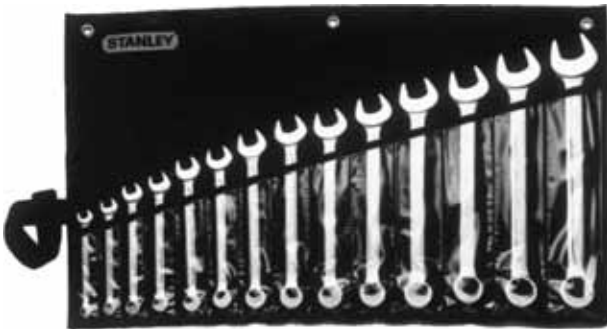

SHALLOW OFFSET RING SPANNER SET - MATTE FINISH

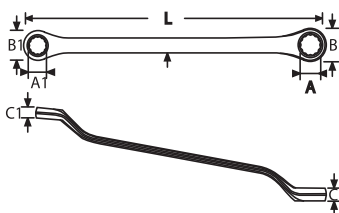

- Maxi-Drive™ system helps reduce fastener rounding
- Matt finishing

PART No.	DESCRIPTION	SIZE	PBQ
70-394E	8 Pc Shallow Offset Ring Spanner Set	6x7, 8x9, 10x11, 12x13, 14x15, 16x17, 18x19, 20x22mm	1
70-395E	12 Pc Shallow Offset Ring Spanner Set	6x7, 8x9, 10x11, 12x13, 14x15, 16x17, 18x19, 20x22mm, 21x23, 24x27, 25x28, 30x32mm	1



STANLEY®

FASTENING TOOLS



**CUSHION GRIP SCREWDRIVERS / SETS,
VDE, TRADITIONAL GRIP SCREWDRIVERS / SETS,
TORX / HEX / T-HANDLE KEYS, SPECIALTY SCREWDRIVERS
SOLDERING IRON, RIVETERS**

CUSHION GRIP™ SCREWDRIVER RANGE OVERVIEW



PHILLIPS®

Tip Size	Bar Length (mm)	Handle Dia.(mm)
PH0	60	16.5
	100	
	125	
	150	
Ph1	75	29.5
	100	
	150	
	200	
PH2	45	29.2
	100	
	150	
	200	32.2
	250	
PH3	150	34.3
	200	
	250	



SLOTTED FLARED

Tip Size	Bar Length (mm)	Handle Dia.(mm)
3mm	100	16.5
	125	
	150	
5mm	75	29.5
	100	
	150	
	200	
6.5mm	45	29.2
	100	
	125	
	150	32.2
	200	
	250	
8mm	150	34.3
	200	
	250	



TORX

Tip Size	Bar Length (mm)	Handle Dia.(mm)
T6	80	16.5
T7	80	16.5
T8	80	16.5
T10	80	16.5
T15	80	29.5
T25	80	29.5
T20	120	29.5
T27	120	152.2
T30		
T40	120	32.2



STANLEY®

CUSHION GRIP™ SCREWDRIVERS NEW RANGE

The STANLEY® CUSHION GRIP™ range is fully patented and meets ANSI standards, proving the range's durability and precision. These tools have easy-to-hold handles that are comfortable and ergonomic.



UNIT PACK

Bold and attractive single packs exploit key features and provide clear user information. Minimal packaging allows full tactile opportunities with security.

FUN FACT

STANLEY® was the first company to make Phillips® screwdrivers in 1937. It was chosen by Henry Phillips, the inventor of the Phillips® head screw.



MAKING EACH TURN COUNT

STANLEY® is one of the preeminent manufacturers of fastening tools and is responsible for helping to elevate the performance of these must-have tools. The excellent quality coupled with durability has propelled the extensive range of fastening tools to be the most highly coveted in the world

SCREWDRIVERS



STANLEY® has a full range of screwdrivers. They are sold individually or packaged in convenient multi-piece kits. We also offer a line of multi-bits and interchangeable bars/bits screwdrivers.

MULTI-TOOLS



This versatile tool features a stunningly compact design. With up to 14 tools compressed into one clever model, the multi-tool is built from solid steel for maximum strength. It also features a 400 in-lbs maximum torque.

BITS



STANLEY® are available as a combination with screwdrivers or as a stand-alone product. Together, they have a magnetism that allows for fast and secure bit changing. Made from chrome vanadium steel, the bits are undoubtedly built to last and come in a conveniently packaged storage option.

HEX KEYS



Made from durable composite materials, all the hex keys feature a compact design and exceed ANSI specifications.



ANSI
American National Standards Institute

CUSHION GRIP SLOTTED SCREWDRIVERS

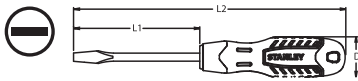

- Bi-material (PP+TPR) soft grip handle providing excellent comfort
- Chrome Vanadium (Cr-V) blade for durability
- Magnetic tips for easy pick up and screw locator
- Three-sided handle allowing more torque with anti-slip and anti-rolling features
- Ergonomic design with finger point in neck-down area for precise control
- Built-in hang hole for easy storage
- Screw tip identification on the handle for faster accessibility

PART No.	DESCRIPTION	SIZE	Tip Size	L1 (mm)	L2 (mm)	D (mm)	PBQ
STHT65181-8	Cushion Grip™ Standard	3 x 100mm	3mm	100	116.5	16.5	12
STHT65182-8	Cushion Grip™ Standard	3 x 125mm	3mm	125	141.5	16.5	12
STHT65186-8	Cushion Grip™ Standard	5 X 75mm	5mm	75	104.5	29.5	12
STHT65187-8	Cushion Grip™ Standard	5 X100mm	5mm	100	129.5	29.5	12
STHT65189-8	Cushion Grip™ Standard	5 X 200mm	5mm	200	229.5	29.5	12
STHT65190-8	Cushion Grip™ Standard	6.5 X 45mm	6.5mm	45	74.2	29.2	12
STHT65191-8	Cushion Grip™ Standard	6.5 X 100mm	6.5mm	100	132.2	32.2	12
STHT65192-8	Cushion Grip™ Standard	6.5 X 125mm	6.5mm	125	157.2	32.2	12
STHT65193-8	Cushion Grip™ Standard	6.5 X 150mm	6.5mm	150	182.2	32.2	12
STHT65194-8	Cushion Grip™ Standard	6.5 X 200mm	6.5mm	200	203.2	3.2	12
STHT65196-8	Cushion Grip™ Standard	8 X 150mm	8mm	150	184.3	34.3	12
STHT65198-8	Cushion Grip™ Standard	8 X 250mm	8mm	250	284.3	34.3	12

CUSHION GRIP Phillips® SCREWDRIVERS

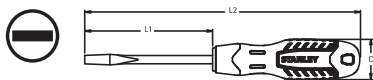

- Bi-material (PP+TPR) soft grip handle providing excellent comfort
- Chrome Vanadium (Cr-V) blade for durability
- Magnetic tips for easy pick up and screw locator
- Three-sided handle allowing more torque with anti-slip and anti-rolling features
- Ergonomic design with finger point in neck-down area for precise control
- Built-in hang hole for easy storage
- Screw tip identification on the handle for faster accessibility

PART No.	DESCRIPTION	SIZE	Tip Size	L1 (mm)	L2 (mm)	D (mm)	PBQ
STHT65157-8	Cushion Grip™	Ph0 x 60mm	Ph0	60	76.5	16.5	12
STHT65158-8	Cushion Grip™	Ph0 x 100mm	Ph0	100	116.5	16.5	12
STHT65159-8	Cushion Grip™	Ph0 x 125mm	Ph0	125	141.5	16.5	12
STHT65160-8	Cushion Grip™	Ph0 X 150mm	Ph0	150	166.5	16.5	12
STHT65162-8	Cushion Grip™	Ph1 xX 75mm	Ph1	75	104.5	29.5	12
STHT65163-8	Cushion Grip™	Ph1 x 100mm	Ph1	100	129.5	29.5	12
STHT65164-8	Cushion Grip™	Ph1 x 150mm	Ph1	150	179.5	29.5	12
STHT65167-8	Cushion Grip™	Ph2 x 100mm	Ph2	100	132.2	32.2	12
STHT65168-8	Cushion Grip™	Ph2 x 125mm	Ph2	125	157.2	32.2	12
STHT65169-8	Cushion Grip™	Ph2 x 150mm	Ph2	150	182.2	32.2	12
STHT65170-8	Cushion Grip™	Ph2 x 200mm	Ph2	200	232.2	32.22	12
STHT65171-8	Cushion Grip™	Ph2 x 250mm	Ph2	250	282.2	32.2	12
STHT65172-8	Cushion Grip™	Ph3 x 150mm	Ph3	150	184.3	34.3	12
STHT65173-8	Cushion Grip™	Ph3 x 200mm	Ph3	200	234.3	34.3	12
STHT65174-8	Cushion Grip™	Ph3 x 250mm	Ph3	250	284.3	34.3	12

CUSHION GRIP2 Torx® SLOTTED SCREWDRIVERS

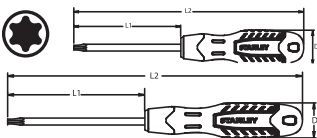

- Bi-material (PP+TPR) soft grip handle providing excellent comfort
- Chrome Vanadium (Cr-V) blade for durability
- Magnetic tips for easy pick up and screw locator
- Three-sided handle allowing more torque with anti-slip and anti-rolling features
- Ergonomic design with finger point in neck-down area for precise control
- Built-in hang hole for easy storage
- Screw tip identification on the handle for faster accessibility

PART No.	DESCRIPTION	SIZE	Tip Size	L1 (mm)	L2 (mm)	D (mm)	PBQ
STHT65146-8	Cushion Grip™ Torx	T7 X 80mm	T7	80	96.5	16.5	12
STHT65147-8	Cushion Grip™ Torx	T8 X 80mm	T8	80	96.5	16.5	12
STHT65148-8	Cushion Grip™ Torx	T10 X 80mm	T10	80	96.5	16.5	12
STHT65149-8	Cushion Grip™ Torx	T15 X 80mm	T15	80	109.5	29.5	12
STHT65150-8	Cushion Grip™ Torx	T20 X 120mm	T20	120	149.5	29.5	12
STHT65151-8	Cushion Grip™ Torx	T25 X 120mm	T25	120	152.2	32.2	12
STHT65152-8	Cushion Grip™ Torx	T27 X 120mm	T27	120	152.2	32.2	12
STHT65153-8	Cushion Grip™ Torx	T30 X 120mm	T30	120	152.2	32.2	12
STHT65154-8	Cushion Grip™ Torx	T40 X 120mm	T40	120	154.3	34.3	12

SLOTTED SCREWDRIVERS



- Improved ergonomic design for maximum grip & torque
- Chrome vanadium blade with tough hardened black oxide
- Nickel plated bar for corrosion resistance
- High quality, heat treated plated bars for lasting "pro" performance & rust resistance

PART No.	DESCRIPTION	SIZE	PBQ
62-241	Screwdriver Slotted	3 X 50mm	10
62-242	Screwdriver Slotted	3 X 75mm	10
62-243	Screwdriver Slotted	3 X 100mm	10
62-244	Screwdriver Slotted	3 X 150mm	10
62-245	Screwdriver Slotted	4 X 75mm	10
62-246	Screwdriver Slotted	4 X 150mm	10
62-247	Screwdriver Slotted	6 X 100mm	10
62-248	Screwdriver Slotted	6 X 150mm	10
62-249	Screwdriver Slotted	6 X 200mm	10
62-250	Screwdriver Slotted	6 X 250mm	10
62-251	Screwdriver Slotted	6 X 300mm	10
62-252	Screwdriver Slotted	8 X 150mm	10
62-253	Screwdriver Slotted	8 X 200mm	10
62-254	Screwdriver Slotted	8 X 250mm	10
62-255	Screwdriver Slotted	8 X 300mm	10

Phillips® SCREWDRIVERS



- Improved ergonomic design for maximum grip & torque
- Chrome vanadium blade with tough hardened black oxide
- Nickel plated bar for corrosion resistance
- High quality, heat treated plated bars for lasting "pro" performance & rust resistance

PART No.	DESCRIPTION	SIZE	PBQ
62-256	Screwdriver Phillips	#0 X 50mm	10
62-257	Screwdriver Phillips	#0 X 100mm	10
62-258	Screwdriver Phillips	#0 X 150mm	10
62-259	Screwdriver Phillips	#1 X 100mm	10
62-260	Screwdriver Phillips	#1 X 150mm	10
62-261	Screwdriver Phillips	#1 X 200mm	10
62-262	Screwdriver Phillips	#2 X 100mm	10
62-263	Screwdriver Phillips	#2 X 150mm	10
62-264	Screwdriver Phillips	#2 X 200mm	10
62-265	Screwdriver Phillips	#2 X 250mm	10
62-266	Screwdriver Phillips	#2 X 300mm	10
62-267	Screwdriver Phillips	#3 X 150mm	10
62-268	Screwdriver Phillips	#3 X 200mm	10
62-269	Screwdriver Phillips	#3 X 250mm	10
62-270	Screwdriver Phillips	#3 X 300mm	10

2-in-1 SCREWDRIVERS



PART No.	DESCRIPTION	SIZE	BLADE LENGTH	PBQ
66-432	Phillips	#2 X Flat 6.0mm X 28mm (stubby)	38mm	12
66-433	Phillips	#0 X Flat 3.5mm X 55mm	55mm	12
66-434	Phillips	#1 X Flat 5.0mm X 75mm	75mm	12
66-435	Phillips	#00 X Flat 2.3mm X 60mm	60mm	12
66-436	Phillips	#1 X Phillips #0 X 200mm	200mm	12
66-437	Phillips	#2 X Phillips #1 X 200mm	200mm	12
66-438	Phillips	#3 X Phillips #2 X 200mm	200mm	12
66-439	Phillips	#2 X Flat 6.0mm X 250mm, Insulated	250mm	12
66-446	Phillips	#2 X Flat 6.0mm X 100mm, Insulated	100mm	12
66-447	Phillips	#2 X Flat 6.0mm X 140mm, Insulated	140mm	12
66-448	Phillips	#3 X Flat 8.0mm X 140mm	140mm	12
66-449	Phillips	#2 X Flat 6.0mm X 200mm	200mm	12

CUSHION GRIP SCREWDRIVER SETS



PART No.	DESCRIPTION	PBQ
STHT65242-8	6 Pcs Cushion Grip™ Screwdriver Set	1
STHT92002-8	6 Pcs Set W/Bonus (Tester Included)	

- Phillips® PH1 x 100mm
- Phillips® PH2 x 150mm
- Std Parallel 5mm x 100mm
- Std Parallel 5mm x 150mm
- Slotted 6.5mm x 150mm
- Slotted 5mm x 100mm



16 PCS CUSHION GRIP SCREWDRIVER SET



PART No.	DESCRIPTION & CONTENTS	PBQ
68-0002C	16pcs Cushion Grip Screwdriver Set	1
	Phillips®: #1x100mm, #2x100mm, #2x150mm	
	Slotted: 5x100mm, 6.5x100mm, 6.5x150mm	
	Torx®: T6x80mm, T8x80mm, T15x80mm, T20x120mm	
	Phillips® Precision Screwdriver: #0, #1	
	Slotted Precision Screwdriver: 1.4, 2, 2.4, 3, 4mm	

VDE SCREWDRIVER 6 PC SET WITH BONUS (TESTER)



- ⊖ 3.0 x 100mm
4.0 x 100mm
5.5 x 125mm
6.5 x 150mm
- ⚡ 3.0 x 70mm
- ⊕ PH1 x 80mm
PH2 x 100mm

- Insulation directly injection-moulded around the blade
- Ergonomic, shock resistant, anti slip handle and for greater torque to be applied with less effort
- Each screwdriver is individually tested to 10,000V in a water bath for 10 Sec.

PART No.	DESCRIPTION & CONTENTS	PBQ
65-980	VDE 6 Pc Set With Bonus Tester	1
	Slotted 3x100mm, Slotted 4x100mm,	
	Slotted 5.5x125mm, Standard Parallel 6.5x150mm,	
	Phillips® #1x80mm, Phillips® #2x100mm	



9 WAY SCREWDRIVER SET

-  OPT 1PT 2PT
-  1/8" (3mm) 3/16"(5mm) 1/4"(6mm)

- Interchangeable bars maximize versatility
- Reduces the number of tools user needs to carry
- Storage case included
- Includes: 1/8" Standard Bar, 3/16" Standard Bar, 1/4" Standard Bar, Opt Phillips® Bar, 1pt Phillips® Bar, 2pt Phillips® Bar, 1 Tack Puller, 1 Brad Awl, 1 Hook Driver



PART No.	DESCRIPTION	CONTENTS	PBQ
STHT62511-8	Screwdriver- 9 Way	Cushion Grip River Set, Phillips® #0, #1, #2, Standard 1/8, 3/16, 1/4, 1 Awl, 1 Track Puller, 1 Hook Driver	6



6 WAY SCREWDRIVER

-  1PT 2PT
-  5/16" (8mm)
-  5mm 6mm
-  1/4" (6.5mm)

- Convenient and space-saving design reduces the number of tools users must carry
- Chrome-plated bar resists corrosion
- Slip-resistant rubber grip provides comfort



PART No.	DESCRIPTION	CONTENTS	PBQ
STHT68012-8	Screwdriver 6 Way, Quick Change	Slotted 1/4, 3/16, Phillips® 1 Pt, 2pt Nut Driver 1/4, 5/6	6



CUSHION GRIP MULTI BIT 2 WAY

- Bi-material handle for comfortable grip
- Larger handle for greater torque
- Chrome plated bar for rust resistant
- Magnetized Tips



PART No.	DESCRIPTION	SIZE	PBQ
65-201	Screwdriver Multi Bits 2 Way Slotted	6x100mm, Phillips® #2x100mm	6

10PC MULTI-BIT RATCHETING SCREWDRIVER

-  1PT 2PT
-  1PT 2PT
-  T10 T15
-  1PT 2PT
-  3/16" (5mm) 1/4" (6.5mm)

- Bit storage system for easy visibility, access & security
- Magnetic bit holder for quick, secure change-over of bits
- Top quality, three position audible ratcheting mechanism forward, reverse
- Supplied with 10 bits to suit a wide variety of purpose
- Overall 254mm/10



PART No.	DESCRIPTION & CONTENTS	PBQ
STHT68010-8	Screwdriver Multi Bit Ratcheting-10pcs. 1 & 2 Point Phillips®/Pozidrive® / Robertson, 5 & 6.5mm Slotted, T10 & T15 Torx®	6



6PC PRECISION SCREWDRIVER SET

66-052



- Attractive bi-material handles designed for easy & comfortable grip
- Chrome vanadium steel bars in black oxide finished with hardened tips-HRC 53
- Comes in 6 popular sizes

PART No.	DESCRIPTION & CONTENTS	PBQ
66-039	Precision Screwdriver Set 6pc-0 & 1 Point Phillips®, 1.4,2, 2.4, 3mm - Slotted Steel	12
66-052	Precision Screwdriver Set Bi-material-0 & 1 Point Phillips®, 1.4,2, 2.4, 3mm	6

66-039



SCREWDRIVER INSERT BIT SET

- Made from chrome-vanadium steel
- Recommended for manual applications multi-bit screwdrivers



PART No.	DESCRIPTION & CONTENTS	PBQ
68-071-23	Screwdriver Insert Bit 29pcs Set - Phillips® #1,#2,#3 Pozidrive® Pz1,pz2,pz3,s2 Slotted 6/8, 8/10, 10/12 Torx® T5, T20, T25, T30, Hex 3/32, 1/8, 5/32, S1, S2, S3 Nut Driver: 3/16, 1/4, 5/16, 11/32, 3/8, Bit Holder	6

MULTI TESTER



- Direct detection 12V-220V AC/Dc live objects
- Dispense with battery, economic benefits
- Rapid induction voltage testing & LED display
- CE certification by the EC

PART No.	DESCRIPTION	MEASURING RANGE	PBQ
66-137	Digital Detection Screwdriver	12V - 220V	12

LINESMAN TESTER



- Designed for optimum Industrial/Domestic uses
- As transparent material handle for better visibility for lighting
- Ergonomic Design - hexagonal shape provides better grip
- Better Cap design - Shape of plastic ensure the position of the clip
- Durable Clip - Tilted angle, help user easily hang clip on the pocket
- Test range of 100-500V

PART No.	DESCRIPTION	O/A LENGTH	TIP WIDTH	PBQ
66-119-23	Linesman Tester	127mm / 5 1/2"	3mm	20
66-120	Linesman Tester	178mm / 7 1/2"	5mm	20



**Do
you
know...**

Which happened first?
A. The invention of the light bulb.
B. The manufacturing of STANLEY® screwdrivers.

STANLEY® manufactured screwdriver in 1870;
 Electric light bulb was invented in 1879.

QUALITY MATERIALS FOR HIGH PERFORMANCE

PROFESSIONAL HEX

Attentively engineered, the STANLEY® Hex Key range comes conveniently grouped into sets or as multiples of the same size for common tasks. Hex or Torx drive options are perfectly suited to typical repair and maintenance situations.

Manufactured from S2 grade steel with a choice of short or long variants, spherical head options and up to 25° work angles, you can be sure that these ANSI certified products will live up to expectations.

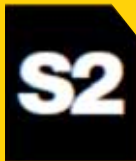

S2 Steel Material



Hex Head

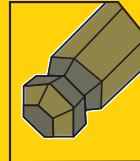

Spherical Head
Allows for 25° working angle



TorxHead

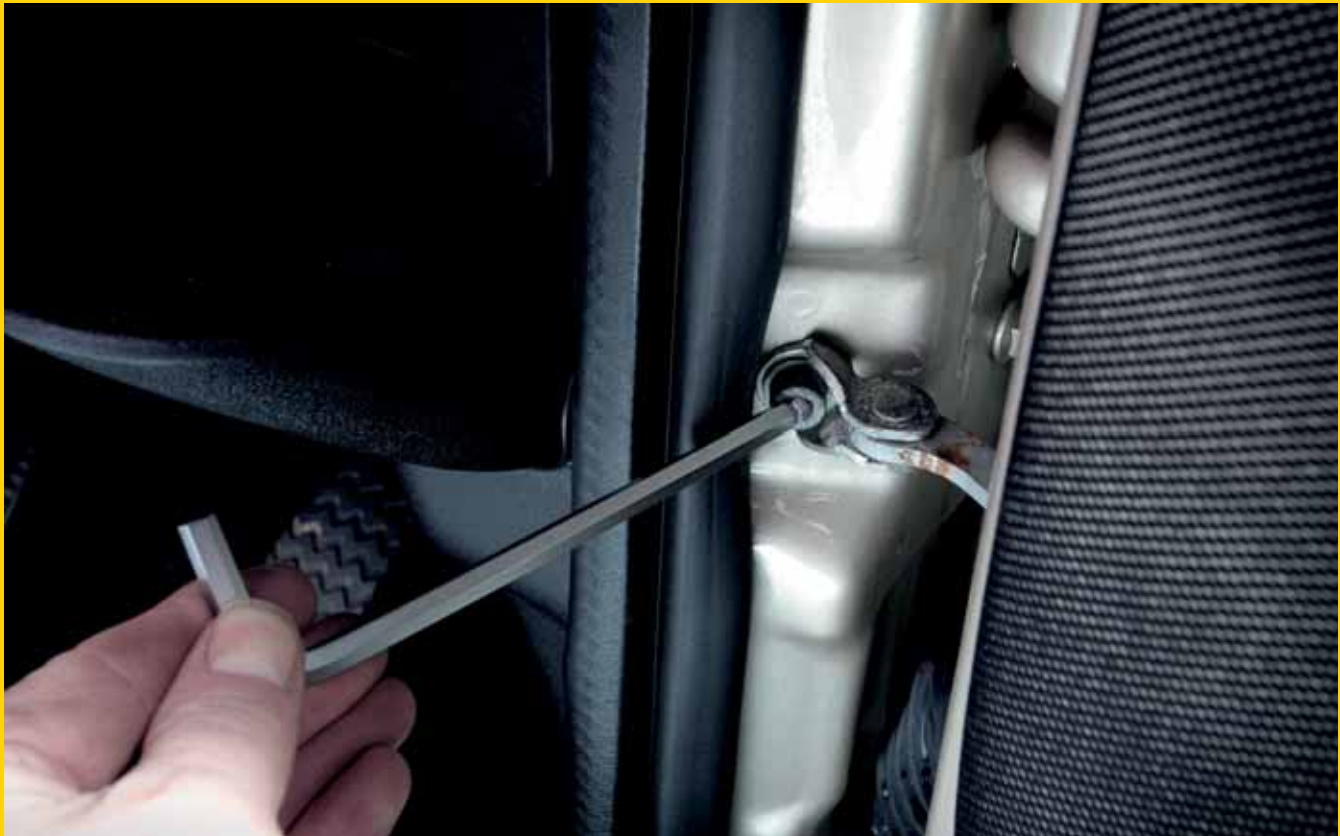

KEY SETS

69-256-22



PART No.	DESCRIPTION	SIZE	PBQ
STMT69213-8	Hex Key Set-ring, 10pcs, Metric	1.5, 2, 2.5, 3, 4, 5, 5.5, 6, 8, 10mm	6
69-230-22	Hex Key Set-ring, 10pcs, Imperial	1/16, 5/64, 3/32, 1/8, 5/32, 3/16, 7/32, 1/4, 5/16, 3/8	12
69-253-22	Hex Key Set 10pc Metric	1.5, 2, 2.5, 3, 4, 5, 5.5, 6, 8, 10mm	12
69-256-22	Hex Key Set, 9pcs, Metric, L/arm Ball	1.5, 2, 2.5, 3, 4, 5, 6, 8, 10mm Ball Tips	12
69-257-22	Hex Key Set, 12pcs, Imperial, L/arm	1/16, 5/64, 3/32, 7/64, 1/8, 9/64, 5/32, 3/16, 7/32, 1/4, 5/16, 3/8 Ball Tips	6

STMT69213-8



12PC IMPERIAL BALL END HEX KEY SET - LONG



- ANSI B18.3.2M-1979 ,GGG-K-275D
- S2 steel
- Spherical head gives a working angle of up to 25°
- HRC 60 +/- 2, 20% higher torque vs Cr-V
- Fine satin finish

PART No.	DESCRIPTION	SIZE	PBQ
94-163-23	12pcs. Long Ball Point Hex Key	1/16, 5/64, 3/32, 7/64, 1/8, 9/64, 5/32, 3/16, 7/32, 1/4, 5/16, 3/8	6



9 PC METRIC BALL END HEX KEY SET - EXTRA LONG



- ANSI B18.3.2M-1979 ,GGG-K-275D
- S2 steel
- Spherical head gives a working angle of up to 25°
- HRC 60 +/- 2, 20% higher torque vs Cr-V
- Fine satin finish

PART No.	DESCRIPTION	SIZE	PBQ
94-158	9 Pcs. Extra Long Hex Key Set (metric)	1.5, 2, 2.5, 3, 4, 5, 6, 8, 10	6



9 PC METRIC BALL END HEX KEY SET - LONG



- ANSI B18.3.2M-1979 ,GGG-K-275D
- S2 steel
- Spherical head gives a working angle of up to 25°
- HRC 60 +/- 2, 20% higher torque vs Cr-V
- Fine satin finish

PART No.	DESCRIPTION	SIZE	PBQ
STMT94162-8	9 Pcs. Extra Long Hex Key Set (metric)	1.5, 2, 2.5, 3, 4, 5, 6, 8, 10 mm	6



8 PC TAMPER PROOF Torx® KEY SET



- ANSI B18.3.2M-1979 ,GGG-K-275D
- S2 steel
- Spherical head gives a working angle of up to 25°
- HRC 60 +/- 2, 20% higher torque vs Cr-V
- Fine satin finish

PART No.	DESCRIPTION	SIZE	PBQ
92-624	8 Pc, Long L-type Tamper Proof Torx, Hex Key-	T6, T7, T8, T9, T10, T15, T20, T25	12

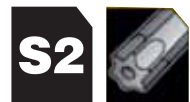

9 PC Torx® KEY SET



- ANSI B18.3.2M-1979 ,GGG-K-275D
- S2 steel
- Spherical head gives a working angle of up to 25°
- HRC 60 +/- 2, 20% higher torque vs Cr-V
- Fine satin finish

PART No.	DESCRIPTION	SIZE	PBQ
STMT92625-8	9 Pcs Torx Key Set	T10,T15,T20,T25,T27,T30,T40,T45,T50	6



METRIC BALL END HEX KEY - LONG

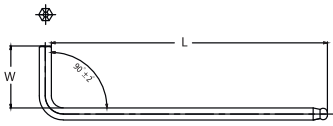

- ANSI B18.3.2M-1979 ,GGG-K-275D
- S2 steel
- Spherical head gives a working angle of up to 25°
- HRC 60 +/- 2, increase 20% torque than Cr-V
- Fine satin finish



PART No.	DESCRIPTION	SIZE	L (MM)	W (MM)	WT. (KG)	PBQ
STMT94099-8	Long Spherical Hex Key 1.5mm	1.5mm	187	55	0.016	6
94-080	Long Spherical Hex Key 2mm	2mm	187	55	0.022	6
94-081	Long Spherical Hex Key 2.5mm	2.5mm	187	55	0.033	6
STMT94102-8	Long Spherical Hex Key 3mm	3mm	187	55	0.05	6
STMT94103-8	Long Spherical Hex Key 4mm	4mm	269	81	0.096	6
STMT94104-8	Long Spherical Hex Key 5mm	5mm	269	81	0.157	6
STMT94106-8	Long Spherical Hex Key 6mm	6mm	269	81	0.258	6
STMT94108-8	Long Spherical Hex Key 8mm	8mm	302	102	0.524	6
94-088	Long Spherical Hex Key 10mm	10mm	-	-	-	6

METRIC HEX KEY - LONG



PART No.	DESCRIPTION	INCREASED LENGTH	SIZE	PBQ
94-149	Long Hex Key	209mm	12mm	2
94-150	Long Hex Key	233mm	14mm	12
94-151	Long Hex Key	240mm	16mm	12



“THE SPHERICAL HEAD HEX KEYS ARE VERY HELPFUL & QUITE COMMON NOW AMONG OTHER BRANDS. WITH THE STANLEY'S & THIS NEW S2 MATERIAL I AM NO LONGER WORRIED ABOUT BREAKING THE SPHERICAL HEADS, WHICH IS TYPICALLY WHAT HAPPEN IF YOU OVER TORQUE THEM”.

HEX KEYS

T HANDLE HEX KEYS

Manufactured from high-strength and durable chrome vanadium steel. Ergonomic design to ease gripping and handling, improving the torque performance. Routed tip finish for better gripping and holding of screws. Special surface treatment to prevent oxidation and corrosion.

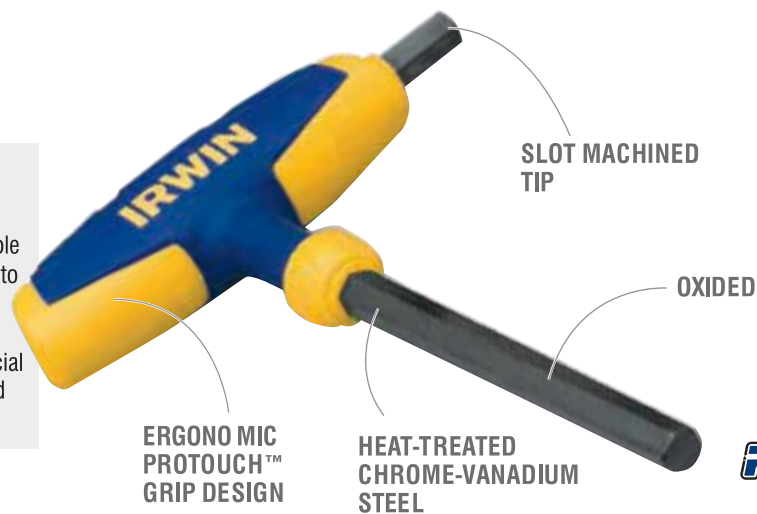

- 1. HEAT-TREATED CHROME-VANADIUM STEEL**
Cr-V with high-resistant heat treatment is high-strength and durable for long tool life
- 2. SLOT MACHINED TIP**
Routed tip finish for better gripping and holding of screws
- 3. ERGONOMIC PROTOUCH™ GRIP DESIGN**
For comfort and better gripping to improve torque performance
- 4. OXIDED**
Special surface treatment to prevent oxidation and corrosion



T-Handle Hex Key Set (mm)
- 8 Pc



T-Handle Hex Key Set (IMPERIAL) - 8 Pc

T HANDLE HEX KEY SETS



PART No.	DESCRIPTION	SIZE	PBQ
T9097008	T-Handle Hex Key Set(mm) – 8pc	2.0, 2.5, 3.0, 4.0, 5.0, 6.0, 8.0, 10.0mm	3
T9097009	T-Handle Hex Key Set(IMPERIAL)	3/32", 1/8", 9/64", 5/32", 3/16", 1/4", 5/16", 3/8"	3

METRIC 2 WAY T-HANDLE HEX KEY



PART No.	DESCRIPTION	SIZE	PBQ
94-346	2-way T-handle Hex Key	4.0mm	12
94-347	2-way T-handle Hex Key	5.0mm	12
94-348	2-way T-handle Hex Key	6.0mm	12
94-350	2-way T-handle Hex Key	8.0mm	12



RIVETERS

STHT69646-8



STHT69800-8



- Versatile tool for joining sheet metal, fabrication, leather, plastic parts etc
- Spring loaded handle ejects rivets stem
- All steel body with non-slip grip & wrench for changing nose pieces
- 69-799 body is nickel plated

PART No.	DESCRIPTION	L(IN)	L(IN)	TYPE	USE RIVERT MATERIALS	USE RIVERT IN.	USE RIVERT MM	PBQ
STHT69646-8	Medium Duty Riveter 3 Nozzles	10	254	3 Nozzles	Steel / Aluminum	1/8, 5/32, 3/16	3, 4, 5	6
STHT69800-8	Heavy Duty Riveter 4 Nozzles	10	254	4 Nozzles	Steel / Aluminum	3/32, 1/8, 5/32, 3/16	2, 3, 4, 5	6

IRWIN® RIVETERS

IRWIN Hand Riveters are engineered to meet the needs of professional and heavy duty users. Each model offers unique features and advantages for construction and industrial applications.

IRWIN HAND RIVETERS R100



1. **DURABLE STEEL BODY**
2. **VINYL GRIP**
prevents slippage
3. **SPRING-LOADED HANDLE**
automatically ejects rivet stem
4. **FOUR INTERCHANGE NOSE PIECES**
for aluminum rivets and wrenches are stored in handle for convenience

SIZE: 2.4mm[3/32"], 3.2mm[1/8"], 4.0mm[5/32"], 4.8mm[3/16"]

R100 HAND RIVETERS



PART No.	LENGTH MM	WIDTH MM	HEIGHT MM	WEIGHT KG	PBQ
1886980	330	115	33	0.56	5

R250 PRO HAND RIVETERS



- Aluminium alloy body with special coating ensures durability under harsh working conditions
- Four interchange nose pieces for aluminium/steel rivets & wrenches are stored in handle for convenience
- Size: 2.4mm[3/32"], 3.2mm[1/8"], 4.0mm[5/32"], 4.8mm[3/16"]

PART No.	LENGTH MM	WIDTH MM	HEIGHT MM	WEIGHT KG	PBQ
1887141	375	150	35	0.63	5

R360 HAND RIVETERS



- 360° Swivel Head Hand Riveter
- Steel/Aluminium Rivet Size: 2.4mm[3/32"], 3.2mm[1/8"], 4.0mm[5/32"], 4.8mm[3/16"]

PART No.	LENGTH MM	WIDTH MM	HEIGHT MM	WEIGHT KG	PBQ
1887142	375	155	37	0.75	5

SOLDERING IRON



- Suitable for soldering light gauge wires, thin metals and hobby work
- Reaches working temperature in 12 seconds
- Comes with 2 soldering tips

PART No.	DESCRIPTION	POWER	PIN HEAD	PBQ
69-031B	Soldering Iron	30W/220V	Round Pin	1

GluePro™ TRIGGER FEED HOT MELT GLUE GUN



- Quality engineered for reliable performance
- Trigger-feed mechanism controls glue flow
- Heats up quickly and bonds within 60 seconds
- Uses standard GS10DT hot melt glue sticks
- Fold-out stand for safe, handy storage while in use

PART No.	DESCRIPTION	POWER	GLUE STICK SIZE	PBQ
69-GR20B	Glue-reg Gun Round Pin	100-240V CE	GS20DT / 25DT / GS260 / GS500	6

LIGHT DUTY STAPLE GUN



- All plastic Light-Duty Staple Gun
- Large window on stapler for indicating when staples need to be reloaded
- Used for screen repairs, light upholstery, craft projects, office, home, & school tacking

PART No.	DESCRIPTION	LENGTH	STAPLES	PBQ
6-TR35	Light Duty Staple Gun	5- 5/8 Inch (143mm)	1/4 In (6mm), 5/16 In (8mm), 3/8 In (10mm)	6

LIGHT DUTY 24-GUAGE STAPLES



- Only suitable for light duty staplers
- TR45 takes all sizes and 0-TR40 takes 6,8 and 10mm

PART No.	LENGTH	CROWN WIDTH	TYPE	PACK SIZE	PBQ
1-TRA204T	6mm	12mm	Chisel Point	1000	7
1-TRA205T	8mm	12mm	Chisel Point	1000	6
1-TRA206T	10mm	12mm	Chisel Point	1000	5

STANLEY®

SOCKETS & RATCHETS ACCESSORIES



1/4, 3/8, 1/2 & 3/4 DRIVE SOCKETS

1/4, 3/8, 1/2 & 3/4 RATCHETS & ACCESSORIES

T-HANDLE SOCKETS & 1/2 IMPACT TOOLS

138 MILLION SOCKETS

is what is produced Every Year in STANLEY® Factories across the globe. We have been doing this for more than **40 years.**



All stanley Mechanics Tools , Sockets & Accessories are made of Chrome Vanadium (CR-V) steel material.

Products meets or exceeds applicable ANSI and DIN standards (DIN - Deutches Institute for Normang e.v.)

Maxi-Drive™

Patented gripping designed to out perform conventional drive configuration
 Reduces the chance of rounding fastener corners and extends fastener life
 Enables to turn worn or rounded fasteners



Stanley Socket & Ratchets

Stanley offers a complete range of sockets and 1/4, 3/8, 1/2 & 3/4 drive tools. Our sockets sets combine the most popular tools in drop tested durable multi use cases convenient for storage and transporting to the work site.

Stanley drive tools are forged from high quality steel and finished in high-polish double Nickle Chromium Alloy and are ergonomically designed and have an easy-to-use, thumb-operated reverse-switch mechanism. Sockets and extensions remain locked onto the drive until disengaged with an easy-to-reach, low-profile quick-release button.

Stanley sockets feature our MAXI-DRIVE design, a unique radius corner design which provides 15% more torque to tighten fasteners easily and prevent rounding of the fastener.

MAXI-DRIVE helps reduce fastener wear & tear by minimizing contact on the outer 5% of the fastener; helping increase life expectancy of the fastener. It also helps reduce slipping on frozen or rusted fasteners.

All Stanley Ratchets, Sockets and Wrenches are manufactured globally, to Stanley specifications, meeting or exceeding ANSI, DIN specifications.



1/4" STANDARD SOCKETS 6 POINTS

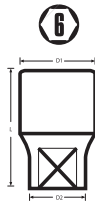

- ASME B107.5M, DIN 3124, ISO 1174-1, ISO 1711-1, ISO 691
- Maxi-Drive™ system helps reduce fastener rounding
- Chrome vanadium steel
- For manual use

1/4 Drive

PART No.	DESCRIPTION	SIZE	L(MM)	D1(MM)	D2(MM)	WT.(KG)	PBQ
STMT72872-8B-12	1/4" 6 Pt Standard Socket	3.5mm	25	12	6.4	0.010	18
STMT72873-8B-12	1/4" 6 Pt Standard Socket	4mm	25	12	6.9	0.010	18
STMT72874-8B-12	1/4" 6 Pt Standard Socket	4.5mm	25	12	7.5	0.011	18
STMT72875-8B-12	1/4" 6 Pt Standard Socket	5mm	25	12	8.1	0.010	18
STMT72876-8B-12	1/4" 6 Pt Standard Socket	5.5mm	25	12	8.8	0.010	18
STMT72877-8B-12	1/4" 6 Pt Standard Socket	6mm	25	12	9.4	0.011	18
STMT72878-8B-12	1/4" 6 Pt Standard Socket	7mm	25	12	10.9	0.012	18
STMT72879-8B-12	1/4" 6 Pt Standard Socket	8mm	25	12	11.5	0.012	18
STMT72880-8B-12	1/4" 6 Pt Standard Socket	9mm	25	13.2	12	0.015	15
STMT72881-8B-12	1/4" 6 Pt Standard Socket	10mm	25	14.7	13	0.020	15
STMT72882-8B-12	1/4" 6 Pt Standard Socket	11mm	25	16	13	0.023	13
STMT72883-8B-12	1/4" 6 Pt Standard Socket	12mm	25	16.9	13.5	0.025	8
STMT72884-8B-12	1/4" 6 Pt Standard Socket	13mm	25	14.7	14	0.028	8
STMT72885-8B-12	1/4" 6 Pt Standard Socket	14mm	25	19.7	16	0.036	8



1/4" DEEP SOCKETS 6 POINTS



- ASME B107.5M, ISO 1174-1, ISO 1711-1, ISO 691
- Maxi-Drive™ system helps reduce fastener rounding
- Chrome vanadium steel
- For manual use

1/4 Drive

PART No.	DESCRIPTION	SIZE	L(MM)	D1(MM)	D2(MM)	WT.(KG)	PBQ
STMT73197-8B-12	1/4" 6 Pt Deep Socket	4mm	49.5	11.8	6.9	0.021	18
STMT73198-8B-12	1/4" 6 Pt Deep Socket	5mm	49.5	11.8	8	0.021	18
STMT73199-8B-12	1/4" 6 Pt Deep Socket	5.5mm	49.5	11.8	8.8	0.022	18
STMT73200-8B-12	1/4" 6 Pt Deep Socket	6mm	49.5	11.8	9.4	0.022	18
STMT73201-8B-12	1/4" 6 Pt Deep Socket	7mm	49.5	11.8	10.9	0.024	18
STMT73202-8B-12	1/4" 6 Pt Deep Socket	8mm	49.5	11.8	-	0.026	18
STMT73203-8B-12	1/4" 6 Pt Deep Socket	9mm	49.5	12.8	-	0.028	15
STMT73204-8B-12	1/4" 6 Pt Deep Socket	10mm	49.5	14.5	-	0.038	12
STMT73205-8B-12	1/4" 6 Pt Deep Socket	11mm	49.5	15.6	-	0.043	10
STMT73206-8B-12	1/4" 6 Pt Deep Socket	12mm	49.5	16.6	-	0.046	8
STMT73207-8B-12	1/4" 6 Pt Deep Socket	13mm	49.5	17.6	-	0.052	8
STMT73208-8B-12	1/4" 6 Pt Deep Socket	14mm	49.5	19.6	-	0.068	11



3/8" STANDARD SOCKETS 6 POINTS

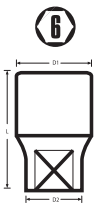

- ASME B107.5M, DIN 3124, ISO 1174-1, ISO 1711-1, ISO 691
- Maxi-Drive™ system helps reduce fastener rounding
- Chrome vanadium steel
- For manual use

3/8 Drive

PART No.	DESCRIPTION	SIZE	L(MM)	D1(MM)	D2(MM)	WT.(KG)	PBQ
STMT72914-8B-12	3/8" 6 Pt Standard Socket	6mm	25.7	17.1	10.1	0.02	12
STMT72915-8B-12	3/8" 6 Pt Standard Socket	7mm	25.7	17.1	11	0.021	12
STMT72916-8B-12	3/8" 6 Pt Standard Socket	8mm	25.7	17.1	12.2	0.025	12
STMT72917-8B-12	3/8" 6 Pt Standard Socket	9mm	25.7	17.1	13.2	0.022	12
STMT72918-8B-12	3/8" 6 Pt Standard Socket	10mm	25.7	17.1	14.7	0.022	12
STMT72919-8B-12	3/8" 6 Pt Standard Socket	11mm	25.7	17.1	16	0.024	12
STMT72920-8B-12	3/8" 6 Pt Standard Socket	12mm	25.7	17.1	16.5	0.024	12
STMT72921-8B-12	3/8" 6 Pt Standard Socket	13mm	25.7	18.3	17	0.026	12
STMT72922-8B-12	3/8" 6 Pt Standard Socket	14mm	25.7	19.5	18	0.028	11
STMT72923-8B-12	3/8" 6 Pt Standard Socket	15mm	25.7	20.4	18	0.028	11
STMT72924-8B-12	3/8" 6 Pt Standard Socket	16mm	29	22.1	19	0.038	15
STMT72925-8B-12	3/8" 6 Pt Standard Socket	17mm	29	23.3	19	0.042	14
STMT72926-8B-12	3/8" 6 Pt Standard Socket	18mm	29	24.2	20	0.046	14
STMT72927-8B-12	3/8" 6 Pt Standard Socket	19mm	29	25.5	21	0.054	11
STMT72928-8B-12	3/8" 6 Pt Standard Socket	20mm	29	26.8	22	0.05	10
STMT72929-8B-12	3/8" 6 Pt Standard Socket	21mm	29	27.7	23	0.056	9
STMT72930-8B-12	3/8" 6 Pt Standard Socket	22mm	29	29.5	24	0.072	8
STMT72931-8B-12	3/8" 6 Pt Standard Socket	23mm	29	30.7	25	0.07	8
STMT72932-8B-12	3/8" 6 Pt Standard Socket	24mm	29	31	26	0.075	7



3/8" STANDARD SOCKETS 12 POINTS

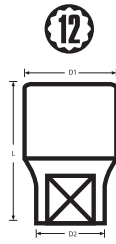

- ASME B107.5M, DIN 3124, ISO 1174-1, ISO 1711-1, ISO 691
- Maxi-Drive™ system helps reduce fastener rounding
- Chrome vanadium steel
- For manual use

3/8 Drive

PART No.	DESCRIPTION	SIZE	L(MM)	D1(MM)	WT.(KG)	PBQ
1-86-342	3/8" 12 Pt Standard Socket	7mm	25.70	17.10	0.02	6
1-86-343	3/8" 12 Pt Standard Socket	8mm	25.70	17.10	0.02	6
1-86-344	3/8" 12 Pt Standard Socket	9mm	25.70	17.10	0.02	6
1-86-345	3/8" 12 Pt Standard Socket	10mm	25.70	17.10	0.02	6
1-86-346	3/8" 12 Pt Standard Socket	11mm	25.70	17.10	0.02	6
1-86-347	3/8" 12 Pt Standard Socket	12mm	25.70	17.10	0.02	6
1-86-348	3/8" 12 Pt Standard Socket	13mm	25.70	18.30	0.03	6
1-86-349	3/8" 12 Pt Standard Socket	14mm	25.70	19.50	0.03	6
1-86-350	3/8" 12 Pt Standard Socket	15mm	25.70	20.40	0.03	6
1-86-351	3/8" 12 Pt Standard Socket	16mm	29.00	22.10	0.04	6
1-86-352	3/8" 12 Pt Standard Socket	17mm	29.00	23.30	0.04	6
1-88-146	3/8" 12 Pt Standard Socket	18mm	29.00	24.20	0.05	6
1-88-147	3/8" 12 Pt Standard Socket	19mm	29.00	25.50	0.05	4
1-88-148	3/8" 12 Pt Standard Socket	20mm	29.00	26.80	0.05	4
1-88-149	3/8" 12 Pt Standard Socket	21mm	29.00	27.70	0.05	4
1-88-150	3/8" 12 Pt Standard Socket	22mm	29.00	29.50	0.07	4
1-88-151	3/8" 12 Pt Standard Socket	23mm	29.00	30.70	0.08	4



1/2" STANDARD SOCKETS 6 POINTS

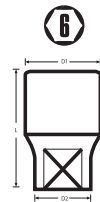

- ASME B107.5M, DIN 3124, ISO 1174-1, ISO 1711-1, ISO 691
- Maxi-Drive™ system helps reduce fastener rounding
- Chrome vanadium steel
- For manual use

1/2 Drive

PART No.	DESCRIPTION	SIZE	L(MM)	D1(MM)	WT.(KG)	PBQ
1-86-508	1/2" 6 Pt Standard Socket	8mm	38.00	21.80	0.04	6
1-86-509	1/2" 6 Pt Standard Socket	9mm	38.00	21.80	0.05	6
1-86-510	1/2" 6 Pt Standard Socket	10mm	38.00	21.80	0.05	6
1-86-511	1/2" 6 Pt Standard Socket	11mm	38.00	21.80	0.05	6
1-86-512	1/2" 6 Pt Standard Socket	12mm	38.00	21.80	0.05	6
1-86-513	1/2" 6 Pt Standard Socket	13mm	38.00	21.80	0.05	6
1-86-514	1/2" 6 Pt Standard Socket	14mm	38.00	21.80	0.06	6
1-86-515	1/2" 6 Pt Standard Socket	15mm	38.00	21.80	0.05	6
1-88-738	1/2" 6 Pt Standard Socket	16mm	38.00	23.30	0.06	6
1-88-739	1/2" 6 Pt Standard Socket	17mm	38.00	24.00	0.07	6
1-88-740	1/2" 6 Pt Standard Socket	18mm	38.00	24.80	0.07	6
1-88-741	1/2" 6 Pt Standard Socket	19mm	38.00	26.30	0.07	6
1-88-742	1/2" 6 Pt Standard Socket	20mm	38.00	26.80	0.07	6
1-88-743	1/2" 6 Pt Standard Socket	21mm	38.00	27.70	0.08	4
1-88-744	1/2" 6 Pt Standard Socket	22mm	40.00	29.80	0.10	4
1-88-745	1/2" 6 Pt Standard Socket	23mm	40.00	30.80	0.10	4
1-88-746	1/2" 6 Pt Standard Socket	24mm	40.00	31.80	0.10	4
1-88-747	1/2" 6 Pt Standard Socket	25mm	40.00	32.80	0.12	4
1-88-748	1/2" 6 Pt Standard Socket	26mm	43.00	33.80	0.11	4
1-88-749	1/2" 6 Pt Standard Socket	27mm	43.00	35.80	0.14	4
1-88-750	1/2" 6 Pt Standard Socket	28mm	43.00	37.6	0.14	4
1-88-751	1/2" 6 Pt Standard Socket	29mm	43.00	37.80	0.15	4
1-88-752	1/2" 6 Pt Standard Socket	30mm	43.00	39.80	0.18	2
1-88-753	1/2" 6 Pt Standard Socket	32mm	43.00	41.80	0.23	2
1-86-196	1/2" 6 Pt Standard Socket	34mm	45.50	43.80	0.30	2
1-86-536	1/2" 6 Pt Standard Socket	36mm	45.50	45.80	0.45	2



1/2" STANDARD SOCKET 12 POINT

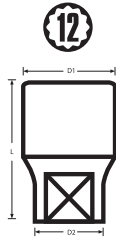

- ASME B107.5M, ISO 1174-1, ISO 1711-1, ISO 691
- Maxi-Drive™ system helps reduce fastener rounding
- Chrome vanadium steel
- For manual use

1/2 Drive

PART No.	DESCRIPTION	SIZE	L(MM)	D1(MM)	WT.(KG)	PBQ
1-86-540	1/2" 12 Pt Standard Socket	8mm	38.00	21.80	0.04	6
1-86-542	1/2" 12 Pt Standard Socket	10mm	38.00	21.80	0.05	6
1-86-543	1/2" 12 Pt Standard Socket	11mm	38.00	21.80	0.05	6
1-86-544	1/2" 12 Pt Standard Socket	12mm	38.00	21.80	0.05	6
1-86-545	1/2" 12 Pt Standard Socket	13mm	38.00	21.80	0.05	6
1-86-546	1/2" 12 Pt Standard Socket	14mm	38.00	21.80	0.06	6
1-86-547	1/2" 12 Pt Standard Socket	15mm	38.00	21.80	0.05	6
1-88-788	1/2" 12 Pt Standard Socket	16mm	38.00	23.30	0.06	6
1-88-789	1/2" 12 Pt Standard Socket	17mm	38.00	24.00	0.07	6
1-88-790	1/2" 12 Pt Standard Socket	18mm	38.00	24.80	0.07	6
1-88-791	1/2" 12 Pt Standard Socket	19mm	38.00	26.30	0.07	6
1-88-792	1/2" 12 Pt Standard Socket	20mm	38.00	26.80	0.07	4
1-88-793	1/2" 12 Pt Standard Socket	21mm	38.00	27.70	0.07	4
1-88-794	1/2" 12 Pt Standard Socket	22mm	40.00	29.80	0.10	4
1-88-796	1/2" 12 Pt Standard Socket	24mm	40.00	31.80	0.10	4
1-88-799	1/2" 12 Pt Standard Socket	27mm	43.00	35.80	0.13	4
1-88-802	1/2" 12 Pt Standard Socket	30mm	43.00	39.80	0.16	2
1-88-803	1/2" 12 Pt Standard Socket	32mm	43.00	41.80	0.22	2
1-86-192	1/2" 12 Pt Standard Socket	34mm	45.50	43.80	0.30	2



1/2" DEEP SOCKETS 6 POINTS



- ASME B107.5M, ISO 1174-1, ISO 1711-1, ISO 691
- Maxi-Drive™ system helps reduce fastener rounding
- Chrome vanadium steel
- For manual use

1/2 Drive

PART No.	DESCRIPTION	SIZE	L	D1	D2	WT.(KG)	PBQ
STMT73324-8B-12	1/2" 6 Pt Deep Socket	10mm	79	22	15.5	0.125	8
STMT73325-8B-12	1/2" 6 Pt Deep Socket	11mm	79	22	16.7	0.13	8
STMT73326-8B-12	1/2" 6 Pt Deep Socket	12mm	79	22	18	0.113	8
STMT73327-8B-12	1/2" 6 Pt Deep Socket	13mm	79	22	19.2	0.12	8
STMT73328-8B-12	1/2" 6 Pt Deep Socket	14mm	79	22	20.5	0.12	8
STMT73329-8B-12	1/2" 6 Pt Deep Socket	15mm	79	22	21	0.115	8
STMT73330-8B-12	1/2" 6 Pt Deep Socket	16mm	79	23.3	22.5	0.131	6
STMT73331-8B-12	1/2" 6 Pt Deep Socket	17mm	79	24	-	0.155	6
STMT73332-8B-12	1/2" 6 Pt Deep Socket	18mm	79	25.3	-	0.165	6
STMT73333-8B-12	1/2" 6 Pt Deep Socket	19mm	79	26.5	-	0.186	4
STMT73334-8B-12	1/2" 6 Pt Deep Socket	21mm	79	27.8	-	0.19	6
STMT73335-8B-12	1/2" 6 Pt Deep Socket	22mm	79	27.8	-	0.222	5
STMT73336-8B-12	1/2" 6 Pt Deep Socket	23mm	79	30.8	-	0.25	5
STMT73337-8B-12	1/2" 6 Pt Deep Socket	24mm	79	31.8	-	0.255	5
STMT73338-8B-12	1/2" 6 Pt Deep Socket	27mm	79	35.8	-	0.325	4
STMT73339-8B-12	1/2" 6 Pt Deep Socket	30mm	79	39.8	-	0.45	2
STMT73340-8B-12	1/2" 6 Pt Deep Socket	32mm	79	41.3	-	0.52	2



1/2" DEEP SOCKETS 12 POINTS

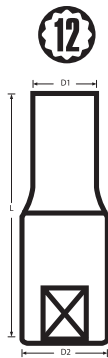

- ASME B107.5M, ISO 1174-1, ISO 1711-1, ISO 691
- Maxi-Drive™ system helps reduce fastener rounding
- Chrome vanadium steel
- For manual use

1/2 Drive

PART No.	DESCRIPTION	SIZE	L(MM)	D1(MM)	D2(MM)	WT.(GM)	PBQ
1-86-418	1/2" 12 Pt Deep Socket	10mm	79	22	15.5	0.13	6
1-86-419	1/2" 12 Pt Deep Socket	11mm	79	22	16.7	0.13	6
1-86-420	1/2" 12 Pt Deep Socket	12mm	79	22	18	0.11	6
1-86-421	1/2" 12 Pt Deep Socket	13mm	79	22	19.2	0.11	6
1-86-422	1/2" 12 Pt Deep Socket	14mm	79	22	20.5	0.12	6
1-86-423	1/2" 12 Pt Deep Socket	15mm	79	22	21	0.11	6
1-86-424	1/2" 12 Pt Deep Socket	16mm	79	23.3	22.5	0.13	6
1-86-425	1/2" 12 Pt Deep Socket	17mm	79	24	-	0.16	6
1-86-426	1/2" 12 Pt Deep Socket	18mm	79	25.3	-	0.17	6
1-86-427	1/2" 12 Pt Deep Socket	19mm	79	26.5	-	0.18	6
1-86-428	1/2" 12 Pt Deep Socket	20mm	79	27.8	-	0.2	6
1-86-429	1/2" 12 Pt Deep Socket	21mm	79	27.8	-	0.19	4
1-86-430	1/2" 12 Pt Deep Socket	22mm	79	27.8	-	0.22	4
1-86-432	1/2" 12 Pt Deep Socket	24mm	79	31.8	-	0.25	4
1-86-433	1/2" 12 Pt Deep Socket	25mm	79	32.8	-	0.3	4
1-86-434	1/2" 12 Pt Deep Socket	26mm	79	33.8	-	0.3	4
1-86-435	1/2" 12 Pt Deep Socket	27mm	79	35.8	-	0.32	4
1-86-436	1/2" 12 Pt Deep Socket	28mm	79	37.6	-	0.45	4
1-86-438	1/2" 12 Pt Deep Socket	30mm	79	39.8	-	0.48	4
1-86-439	1/2" 12 Pt Deep Socket	32mm	79	41.3	-	0.5	4



1/2" HEX BIT SOCKETS

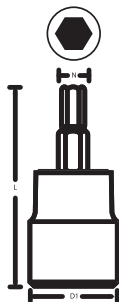

- ISO 1173, ISO 2380-1, ISO 2351-1, ISO 1174-1, ISO 691
- S2 Steel bit
- HRC 60 +/- 2, 20% higher torque vs Cr-V
- For manual use

1/2 Drive

PART No.	DESCRIPTION	SIZE	L(MM)	D1(MM)	N(MM)	WT.(KG)	PBQ
STMT73371-8B	1/2" Hexagonal Bit Socket	4mm	55	22	4	0.06	6
STMT73372-8B	1/2" Hexagonal Bit Socket	5mm	55	22	5	0.06	6
STMT73373-8B	1/2" Hexagonal Bit Socket	6mm	55	22	6	0.06	6
STMT73374-8B	1/2" Hexagonal Bit Socket	7mm	55	22	7	0.06	6
STMT73375-8B	1/2" Hexagonal Bit Socket	8mm	55	22	8	0.065	6
STMT73376-8B	1/2" Hexagonal Bit Socket	9mm	55	22	9	0.075	6
STMT73377-8B	1/2" Hexagonal Bit Socket	10mm	55	22	10	0.08	6
STMT73378-8B	1/2" Hexagonal Bit Socket	12mm	55	22	12	0.085	6
STMT73379-8B	1/2" Hexagonal Bit Socket	14mm	55	22	14	0.098	6
STMT73380-8B	1/2" Hexagonal Bit Socket	17mm	55	25	17	0.14	3
STMT73381-8B	1/2" Hexagonal Bit Socket	19mm	60	27.9	19	0.16	2



“I HAVE BEEN A PRO USER FOR YEARS, THERE IS ALWAYS IMPROVED INNOVATION AND PERFORMANCE EXCELLENCE”

1/2" TORX BIT SOCKET

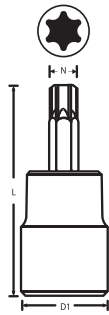

- ISO 1173, ISO 2380-1, ISO 2351-1, ISO 1174-1, ISO 691
- S2 Steel bit
- HRC 60 +/- 2, 20% higher torque vs Cr-V
- For manual use

1/2 Drive

PART No.	DESCRIPTION	L(MM)	D1(MM)	N(MM)	WT.(KG)	PBQ
STMT73389-8B-12	1/2" Torx Bit Socket T20	55	22	T20	0.052	6
STMT73390-8B-12	1/2" Torx Bit Socket T25	55	22	T25	0.052	6
STMT73391-8B-12	1/2" Torx Bit Socket T27	55	22	T27	0.052	6
STMT73392-8B-12	1/2" Torx Bit Socket T30	55	22	T30	0.052	6
STMT73393-8B-12	1/2" Torx Bit Socket T40	55	22	T40	0.052	6
STMT73394-8B-12	1/2" Torx Bit Socket T45	55	22	T45	0.060	6
STMT73395-8B-12	1/2" Torx Bit Socket T50	55	22	T50	0.062	6
STMT73396-8B-12	1/2" Torx Bit Socket T55	55	22	T55	0.072	6
STMT73397-8B-12	1/2" Torx Bit Socket T60	55	22	T60	0.075	6

1/2" SPLINE BIT SOCKET

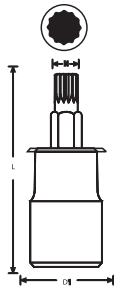

- ISO 1173, ISO 2380-1, ISO 2351-1, ISO 1174-1, ISO 691
- S2 Steel bit
- HRC 60 +/- 2, 20% higher torque vs Cr-V
- For manual use

1/2 Drive

PART No.	DESCRIPTION	L(MM)	D1(MM)	N(MM)	WT.(KG)	PBQ
STMT73415-8B-12	1/2" Spline BIT SOCKET M-5	55	22	M5	0.07	6
STMT73416-8B-12	1/2" Spline BIT SOCKET M-6	55	22	M6	0.07	6
STMT73417-8B-12	1/2" Spline BIT SOCKET M-8	55	22	M8	0.07	6
STMT73418-8B-12	1/2" Spline BIT SOCKET M-10	55	22	M10	0.072	6
STMT73419-8B-12	1/2" Spline BIT SOCKET M-12	55	22	M12	0.072	6
STMT73420-8B-12	1/2" Spline BIT SOCKET M-14	55	22	M14	0.072	6
STMT73421-8B-12	1/2" Spline BIT SOCKET M-16	55	25	M16	0.14	6

1/2" TORX SOCKET

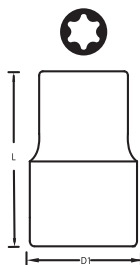

- ISO 1173, ISO 2380-1, ISO 2351-1, ISO 1174-1, ISO 691
- S2 Steel bit
- HRC 60 +/- 2, 20% higher torque vs Cr-V
- For manual use

1/2 Drive

PART No.	DESCRIPTION	L(MM)	D1(MM)	D2(MM)	WT.(KG)	PBQ
STMT73362-8B-12	1/2" Torx Socket E10	40	22	0.05	0.05	15
STMT73363-8B-12	1/2" Torx Socket E11	40	22	0.05	0.05	15
STMT73364-8B-12	1/2" Torx Socket E12	40	22	0.05	0.052	15
STMT73365-8B-12	1/2" Torx Socket E14	40	22	0.05	0.052	15
STMT73366-8B-12	1/2" Torx Socket E16	40	22	0.05	0.056	15
STMT73367-8B-12	1/2" Torx Socket E18	40	22	0.06	0.056	15
STMT73368-8B-12	1/2" Torx Socket E20	40	23.5	0.06	0.058	15
STMT73369-8B-12	1/2" Torx Socket E22	40	25	0.09	0.09	12
STMT73370-8B-12	1/2" Torx Socket E24	40	27	0.11	0.107	9

3/4" STANDARD SOCKETS 6 POINTS



3/4 Drive

PART No.	DESCRIPTION	SIZE	L(MM)	D1(MM)	D2(MM)	WT.(KG)	PBQ
STMT89319-8B-12	3/4" 6pt Socket	19mm	50	36	29.3	0.213	4
STMT89322-8B-12	3/4" 6pt Socket	22mm	50	36	31.3	0.217	4
STMT89324-8B-12	3/4" 6pt Socket	24mm	51	36	33.3	0.216	4
STMT89325-8B-12	3/4" 6pt Socket	25mm	52	36	34.3	0.216	4
STMT89327-8B-12	3/4" 6pt Socket	27mm	55	36	36	0.219	4
STMT89328-8B-12	3/4" 6pt Socket	28mm	52	38	38	0.254	4
STMT89330-8B-12	3/4" 6pt Socket	30mm	55	38	40	0.285	4
STMT89332-8B-12	3/4" 6pt Socket	32mm	56	38	42	0.315	4
STMT89333-8B-12	3/4" 6pt Socket	33mm	56	38	44	0.329	4
STMT89334-8B-12	3/4" 6pt Socket	34mm	56	38	44	0.332	4
STMT89336-8B-12	3/4" 6pt Socket	36mm	58	42	50	0.417	4
STMT89338-8B-12	3/4" 6pt Socket	38mm	60	45	52	0.479	4
STMT89341-8B-12	3/4" 6pt Socket	41mm	64	45	56	0.573	4
STMT89346-8B-12	3/4" 6pt Socket	46mm	68	48	62	0.684	4
STMT89350-8B-12	3/4" 6pt Socket	50mm	72	48	68	0.852	4

3/4" STANDARD SOCKETS 12 POINTS



3/4 Drive

PART No.	DESCRIPTION	SIZE	L(MM)	D1(MM)	D2(MM)	WT.(KG)	PBQ
STMT89619-8B-12	3/4" 12 Pts Socket	19mm	50	36	29.3	0.213	4
STMT89624-8B-12	3/4" 12 Pts Socket	24mm	51	36	33.3	0.216	4
STMT89627-8B-12	3/4" 12 Pts Socket	27mm	52	36	36	0.219	4
STMT89628-8B-12	3/4" 12 Pts Socket	28mm	52	38	38	0.254	4
STMT89630-8B-12	3/4" 12 Pts Socket	30mm	54	38	40	0.285	4
STMT89636-8B-12	3/4" 12 Pts Socket	36mm	58	42	50	0.417	4
STMT89638-8B-12	3/4" 12 Pts Socket	38mm	60	45	52	0.479	4
STMT89650-8B-12	3/4" 12 Pts Socket	50mm	72	48	68	0.852	4
STMT89655-8B-12	3/4" 12 Pts Socket	55mm	76	48	74	0.994	4



3/4" DRIVE ROUND HEAD RATCHET

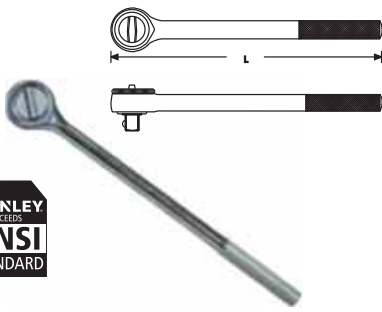

- ASME B107.10M-2005, ISO 3315, DIN 3122, ISO 1174-1
- Chrome vanadium steel
- Knurled handle

PART No.	DESCRIPTION	SIZE	WT.(KG)	PBQ
STMT91316-8B-12	3/4" Ratchet With Handle	500	1.93	2



QUICK RELEASE PEAR HEAD RATCHET



- ASME B107.10M-2005, ISO 3315, DIN 3122, ISO 1174-1
- Socket safety lock
- Lever reverse: rotation direction displayed
- Chrome vanadium steel
- Chemical resistant ergonomic bimaterial handle
- Quick release button

PART No.	DESCRIPTION	L(MM)	D1 (MM)	D2 (MM)	Gear	Increment	WT (KG)
STMT95895-8B-12	1/4" Sd Pear Head Ratchet P9	144	20	21.2	60	6 deg	0.097
STMT95894-8B-12	3/8" Sd Pear Head Ratchet P9	195	27	27.4	60	6 deg	0.234
STMT95893-8B-12	1/2" Sd Pear Head Ratchet P9	240	32.5	35.7	60	6 deg	0.420
1-93-637	3/8 Sq. Dr. Pear Head Ratchet Np7	-	-	-	-	-	0.250
1-93-638	1/2" Sq. Dr. Pear Head Ratchet Np7	-	-	-	-	-	0.250



QUICK RELEASE ROUND HEAD RATCHET



- ASME B107.10M-2005, ISO 3315, DIN 3122, ISO 1174-1
- Socket safety lock
- Chrome vanadium steel
- Quick release button

PART No.	DESCRIPTION	L (MM)	D1 (MM)	D2 (MM)	GEAR	INCREMENT	WT. (KG)	PBQ
STMT86395-8B-12	1/4" Round Head Ratchet	210	36	37	45	8°	0.347	8
1-86-397	Ratchet 1/2 Sq. Dr Quick Release	-	-	-	-	-	0.620	4
STMT86396-8B-12	3/8" Round Head Ratchet	160	21	28	45	8°	0.151	4



RATCHET ROUND HEAD



- Round head ratchet for tight access area
- Anti-slip & durable knurled metal handle design that suits most industrial applications
- Flip drive ratchet head for easy direction rotates

PART No.	DESCRIPTION	WT.(GM)	PBQ
1-87-720	Ratchet 1/2 Sq. Dr. Flip Drive	150g	4



FLEX HANDLE

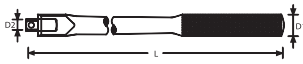

- ASME B107.10M, ISO 3315 - DIN 3122 -ISO 1174-1
- Smooth-action joint
- Hinged handle for easier access
- Knurled handle



PART No.	DESCRIPTION	L(MM)	D1(MM)	D2(MM)	WT.(KG)	PBQ
1-86-405	1/2" 1/2 SQ. DR. FLEX HANDLE	250	30	19	0.53	4
STMT89302-8B-12	3/4" SWIVEL HANDLE	465	95	25	1.406	2



EXTENSION BARS



- ASME B107.10M, ISO 3316 - DIN 3123 - ISO 1174-1
- Fully polished finish
- Chrome vanadium steel
- For manual use



PART No.	DESCRIPTION	SIZE	L(MM)	D1(MM)	D2(MM)	WT.(KG)
STMT91059-8B-12	1/4" Extension	50mm	50	12.5	-	0.025
STMT91339-8B-12	1/4" Extension	100mm	100	12.5	-	0.045
STMT86007-8B-12	1/4" Extension	150mm	150	-	-	0.0665
STMT86206-8B-12	3/8" Extension	75mm	76	17	-	0.073
STMT86207-8B-12	3/8" Extension	125mm	152	17	-	0.145
STMT86208-8B-12	3/8" Extension	250mm	254	17	-	0.23
1-86-406	Extension Bar 1/2 Sq. Dr.	63mm	-	-	-	-
STMT88930-8B-12	1/2" Extension	75mm	76	22.5	-	0.123
STMT86407-8B-12	1/2" Extension	125mm	127	22.5	-	0.22
STMT86408-8B-12	1/2" Extension	250mm	254	22.5	-	0.42
STMT89307-8B-12	3/4" Extension	200mm	203	35	35	0.72
STMT89308-8B-12	3/4" Extension	400mm	400	35	35	1.24



FLEX EXTENSION



- ASME B107.10M, ISO 3316 - DIN 3123 - ISO 1174-1
- Fully polished finish
- Chrome vanadium steel
- For manual use



PART No.	DESCRIPTION	L(MM)	D1(MM)	D2(MM)	WT.(KG)	PBQ
STMT86001-8B-12	1/4" Flexible Extension 150mm	150	12.2	12.2	0.064	10



SPEEDER HANDLE

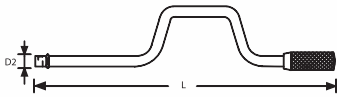

- ASME B107.10M, ISO 3315 - DIN 3122 - ISO 1174-1
- Fast rotation handle
- Knurled handle



PART No.	DESCRIPTION	L(MM)	D(MM)	WT.(KG)	PBQ
1-86-212	3/8" Speed Handle	380	17	0.318	6
STMT86412-8B-12	1/2" Speed Handle	420	21	0.554	4



L - HANDLE

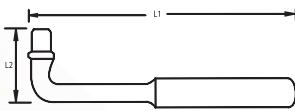

- ASME B107.10M, ISO 1174-1, ISO 691 SO 1174-1, ISO 691
- Chrome vanadium steel
- Knurled handle

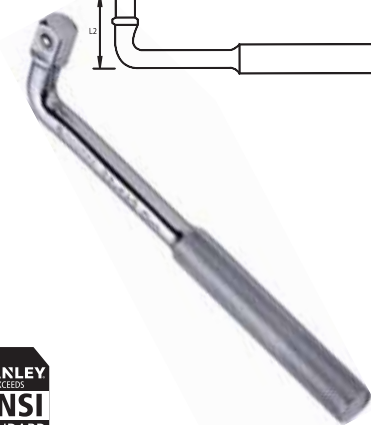

PART No.	DESCRIPTION	SIZE	WT.(KG)	PBQ
86-493-22	L-handle 1/2 Sq. Dr	250mm	0.325	20



SLIDING T-BAR

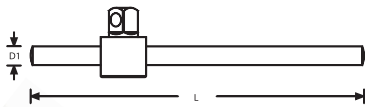

- ASME B107.10M, ISO 3315 - DIN 3122 - ISO 1174-1
- Sliding head
- Chrome vanadium steel
- For manual use

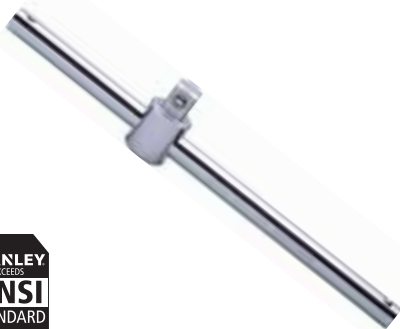

PART No.	DESCRIPTION	L(MM)	D1(MM)	WT.(KG)	PBQ
STMT86010-8B-12	1/4" Sliding Tee	108	6.4	0.041	10
STMT86202-8B-12	3/8" Sliding Tee	170	9.5	0.133	4
1-86-440	1/2" Sliding Tee	243	12.7	0.41	4
STMT89303-8B-12	3/4" Sliding Tee	480	21	1.400	2



ADAPTERS

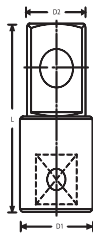

- ASME B107.10M, ISO 1174-1, ISO 691
- Chrome vanadium steel
- For manual use

PART No.	DESCRIPTION	L(MM)	D1(MM)	D2(MM)	WT.(KG)	PBQ
STMT86002-8B-12	Coupler 1/4" To 3/8"	25	12.2	10	0.016	15
1-86-214	1/2" Sq. Dr. F* 3/8 Sq. Dr. M	25.4	17.4	6.3	0.020	12
1-86-414	3/8"sq. Dr F* 1/2 Sq. Dr. M	34.5	22	10	0.046	15
1-86-215	1/2"sq. Dr. F* 3/4 Sq. Dr. M	36	18	10	0.044	8
1-88-558	1/2"sq. Dr. F* 3/4 Sq. Dr. M	42	25.2	19	0.111	12
STMT88908-8B-12	Coupler 3/4" To 1/2"	62	37.3	25.4	0.16	4



MAGNETIC PICK UP SOCKET

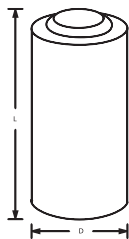

- ISO 1174-1, ISO 691
- Chrome vanadium steel
- For manual use

PART No.	DESCRIPTION	L(MM)	D(MM)	WT.(KG)	PBQ
STMT73082-8B-12	1/4" Magnetic Pick Up Socket	25.2	14.2	0.024	15



BIT HOLDER

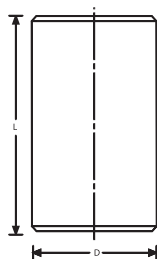

- ASME B107.10, ISO 1174-1, ISO 691
- Chrome vanadium steel
- For manual use

PART No.	DESCRIPTION	L(MM)	D(MM)	WT.(KG)	PBQ
STMT86124-8B-12	1/4" Bit Holder	25.2	14.2	0.024	15
STMT86250-8B-12	3/8" Holder For 1/4 Bits	28.6	17.3	0.024	11



UNIVERSAL JOINT

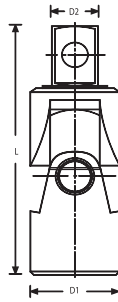

- ASME B107.10, ISO 1174-1, ISO 691
- Chrome vanadium steel
- For manual use

PART No.	DESCRIPTION	L(MM)	D1(MM)	D2(MM)	WT.(KG)	PBQ
STMT86011-8B-12	1/4" Universal Joint	34	14	6.3	0.0218	8
STMT86211-8B-12	3/8" Universal Joint	54.2	19	10	0.060	8
STMT86411-8B-12	1/2" Universal Joint	68.5	24.9	12.5	0.1426	10
STMT93091-8B-12	3/4" Universal Joint	110	40	19	0.225	4



SPARK PLUG SOCKET



- ASME B107.34M
- Chrome vanadium steel
- For manual use

PART No.	DESCRIPTION	L(MM)	D1(MM)	D2(MM)	WT.(KG)	PBQ
STMT88941-8B-12	3/8" 6 PT Spark Plug Socket 16MM	65	22	10	0.097	2
STMT88996-8B-12	1/2" 12 PT Spark Plug Socket 21MM	70	27	12.5	0.146	4



6 POINT T-HANDLE

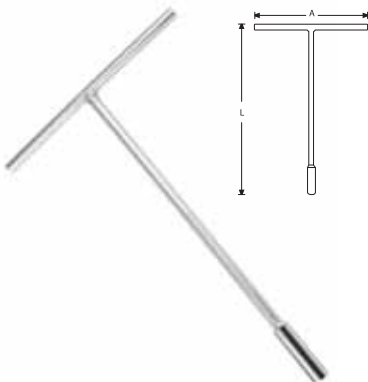

- High quality Chrome Vanadium steel forging
- Thin wall design

PART No.	DESCRIPTION	SIZE	L(MM)	A(MM)	WT.(KG)	PBQ
STMT93302-8	T-bar Socket	8mm	310	200	0.306	10
STMT93303-8	T-bar Socket	9mm	310	200	0.312	10
STMT93304-8	T-bar Socket	10mm	310	200	0.32	10
STMT93305-8	T-bar Socket	11mm	310	200	0.322	10
STMT93306-8	T-bar Socket	12mm	310	200	0.326	10
STMT93307-8	T-bar Socket	13mm	310	250	0.36	10
STMT93308-8	T-bar Socket	14mm	310	250	0.374	10
STMT93309-8	T-bar Socket	17mm	310	250	0.552	10



PNEUMATIC TOOL

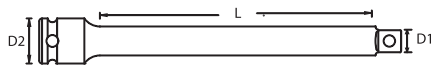

- ASME B107.2, ISO 1174-2
- Designed specifically for impact tools - maximum performance and safety
- Chrome-Molybdenum steel

PART No.	DESCRIPTION	L(MM)	D1(MM)	D2(MM)	WT.(KG)	PBQ
STMT73493-8B	1/2" Impact Extension 50mm	50	25	16.5	0.11	10
STMT73494-8B	1/2" Impact Extension 125mm	125	25	16.5	0.226	10
STMT73495-8B	1/2" Impact Extension 250mm	250	25	16.5	0.427	10



1/2" IMPACT DEEP SOCKETS

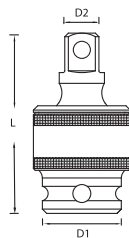

- ASME B107.2, ISO 1174-2
- Designed specifically for impact tools - maximum performance and safety
- Chrome-Molybdenum steel

PART No.	DESCRIPTION	L(MM)	D1(MM)	D2(MM)	WT.(KG)	PBQ
STMT73497-8B	1/2" Impact Universal Joint	63	30	34	0.194	10



“ STANLEY OFFERS A COMPREHENSIVE RANGE OF AIR TOOLS AND SOCKETS ”.

STANLEY®

MAXIMUM TORQUE
500ft-lbs. / 678Nm



COMPACT ALUMINUM HOUSING

For better access in even tight areas
weight: 2.86 lbs / 1.3 kg



PROGRESSIVE TRIGGER
Fine speed control

SPEED CONTROL DISC SWITCH
3 positions, one hand operation

ONE HAND ROTATION SWITCH
Forward / reverse for either left/right handed users



Highly suitable for small / hard to reach spaces.

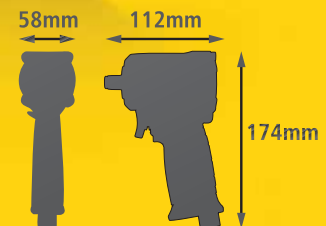

PNEUMATIC TOOL



- Compact aluminium housing
- Progressive Trigger Fine speed control
- Speed control Disc Switch
- 3 positions, one hand operation

PART No.	DESCRIPTION	Anvil (IN)	Max. Torque (N.m)	Free Speed	Average air Consumption (CFM)	L(MM)	Hose Size (IN)	Air Inlet (PT)	Air Pressure (PSI)	Wt.(g)	PBQ
STMT74840-800	1/2" Mini Impact Wrench	1/2"	678	10,000	5.3"	112	3/8"	1/4"	90	1.3"	1

1/2" IMPACT DEEP SOCKETS



- ASME B107.33M, ASME B107.17M, DIN 7422, ISO 2725-2, ISO 1174-2, ISO 1711-2
- Designed specifically for impact tools - maximum performance and safety
- Chrome-Molybdenum steel

PART No.	DESCRIPTION	L(MM)	D1(MM)	D2(MM)	WT.(KG)	PBQ
STMT91379-8B	1/2" Impact Deep Socket 12mm	82	25	19	0.14	10
STMT87501-8B	1/2" Impact Deep Socket 14mm	82	25	21.5	0.153	10
STMT87504-8B	1/2" Impact Deep Socket 17mm	82	25	26	0.2	10
STMT87506-8B	1/2" Impact Deep Socket 19mm	82	25	28	0.225	10
STMT87507-8B	1/2" Impact Deep Socket 21mm	82	25	30	0.243	-



1/2" IMPACT STANDARD SOCKET SET

PART No.	DESCRIPTION	L(MM)	W(MM)	WT.(KG)	PBQ
STMT73916-8	13 Pcs 1/2" Impact Standard Socket Set	480	150	3.144	3



- 1/2" Impact Standard Socket 10mm
- 1/2" Impact Standard Socket 11mm
- 1/2" Impact Standard Socket 12mm
- 1/2" Impact Standard Socket 13mm
- 1/2" Impact Standard Socket 14mm
- 1/2" Impact Standard Socket 15mm
- 1/2" Impact Standard Socket 16mm
- 1/2" Impact Standard Socket 17mm
- 1/2" Impact Standard Socket 18mm
- 1/2" Impact Standard Socket 19mm
- 1/2" Impact Standard Socket 21mm
- 1/2" Impact Standard Socket 22mm
- 1/2" Impact Standard Socket 24mm



STANLEY®

TOOLS SETS



MECHANICS TOOL SETS

TELECOMMUNICATION TOOL SETS

STANLEY®

**MECHANIC
TOOLS
SOLUTIONS
THAT
OUTPERFORM
YOUR NEEDS &
EXPECTATIONS**

For 175 years, STANLEY® has been Flexing its tool manufacturing muscles by continuously enhancing and enlarging its already massive collection of high-quality tool solutions.

With the introduction of new STANLEY® AUTOMOTIVE products, the company is offering industry-proven tools that are designed specifically for the needs of mechanics. These include roller cabinets and storage solutions for garages and a wide variety of tools such as ratchets, sockets, wrenches and accessories in many styles, sizes and finishes.

With over 175 years of experience in the industry, STANLEY® is renowned for designing, developing and making good quality tools. At the STANLEY® lab, every product undergoes stringent tests in order to maintain the brand's consistent quality and excellent performance standards.

150 PC MASTER SET



PART No.	DESCRIPTION	PBQ
94-181	150 Pc Master Set	1

- 10Pc 1/4 DRIVE 6 POINT SOCKETS: 5/32, 3/16, 7/32, 1/4, 9/32, 5/16, 11/32, 3/8, 7/16, 1/2
- 10Pc 1/4 DRIVE 6 POINT METRIC SOCKETS: 4, 5, 6, 7, 8, 9, 10, 11, 12, 13mm
- 6 Pc 1/4 DRIVE 6 POINT METRIC DEEP SOCKETS: 4, 5, 6, 7, 8, 9mm
- 3 Pc 3/8 DRIVE PHILLIPS® BIT SOCKETS: #1, #2, #3
- 9 Pc 3/8 DRIVE 6 POINT SOCKET: 3/8, 7/16, 1/2, 9/16, 5/8, 11/16, 3/4, 13/16, 7/8
- 6 Pc 3/8 DRIVE 6 POINT METRIC DEEP SOCKETS: 10, 11, 12, 13, 14, 15, mm
- 2 Pc 3/8 DRIVE EXTENSION BAR - LOCKING: 3, 6 (76, 152mm)
- 2 Pc 3/8 DRIVE SPARK PLUG METRIC SOCKETS: 16, 21mm
- 8 Pc 3/8 DRIVE 6 POINT TORX® SOCKETS: E8, E10, E11, E12, E14, E16, E18, E20
- 11Pc 3/8 DRIVE 6 POINT METRIC SOCKETS: 9, 10, 11, 12, 13, 14, 15, 16, 17, 18, 19mm
- 4 Pc 1/2 DRIVE IMPACT 6 POINT METRIC SOCKETS: 17, 19, 21, 23mm
- 4 Pc 1/2 DRIVE 12 POINT SOCKETS: 15/16, 1, 1-1/16, 1-1/4
- 7 Pc 1/2 DRIVE 12 POINT SOCKETS: 20, 21, 22, 24, 27, 30, 32mm
- 6 Pc 3/8 DRIVE HEX BIT SOCKET 3, 4, 5, 6, 8, 10mm
- 3 Pc 3/8 DRIVE POZIDRIVE® BIT SOCKETS: #1, #2, #3,
- 12Pc FULL POLISH LONG PANEL COMBINATION WRENCHES: 8, 9, 10, 11, 12, 13, 14, 15, 16, 17, 18, 19mm
- 3 Pc DOUBLE BOX REVERSAL METRIC RATCHETING WRENCHES: 8x9, 12x13, 17x19mm
- 7 Pc 1/4 DRIVE TORX (HOLE) BIT: T-10, T-15, T-20, T-25, T-27, T-30, T-40
- 10Pc HEX KEY: 1.5, 2.0, 2.5, 3.0, 4, 5, 6, 7, 8, 10mm
- 1 Pc 1/4 DRIVE PEAR HEAD RACHET WITH COMFORT GRIP
- 1 Pc 1/4 DRIVE EXTENSION BAR 100mm
- 1 Pc 1/4 SPINNER HANDLE
- 6 Pc 1/2 DRIVE DEEP 6 POINT METRIC SOCKET : 10, 12, 13, 14, 17, 19mm
- 2 Pc 1/2 DRIVE EXTENSION BAR : 5, 10 (125, 150mm)
- 3 Pc 3/8 DRIVE SLOTTED BIT SOCKETS: 4, 5.5, 6.5mm
- 7 Pc 3/8 DRIVE TORX® BIT SOCKETS : T-20, T-30, T-40, T-45, T-50, T-55, T-60
- 1 Pc 1/4 DRIVE UNIVERSAL JOINT
- 1 Pc 1/4 DRIVE ADAPTER
- 1 Pc 3/8 DRIVE PEAR HEAD RATCHET WITH COMFORT GRIP
- 1 Pc 3/8 DRIVE UNIVERSAL JOINT
- 1 Pc 1/2 DRIVE PEAR HEAD RATCHET WITH COMFORT GRIP
- 1 Pc 1/2 DRIVE UNIVERSAL JOINT



132 PC METRIC & A/F TOOL KIT



PART No.	DESCRIPTION	PBQ
99-059-12	132Pc Metric & A/F Tool Kit	1

- 1/2" Drive Socket Accessories: Heavy Duty Ratchet, 75, 125 & 250mm Extensions, Universal Joint, Flex Bar
- 1/2" Drive Spark Plug Sockets: 5/8 & 13/16"
- 1/2" Drive Standard Sockets: Metric: 10, 11, 12, 13, 14, 15, 16, 17, 18, 19, 20, 21, 22, 23, 24, 27, 30, 32mm A/F: 3/8, 7/16, 1/2, 9/16, 5/8, 11/16, 3/4, 13/16, 7/8, 15/16, 1, 1-1/16, 1-1/8, 1-3/16, 1-1/4"
- 1/4" Drive Socket Accessories: Heavy Duty Ratchet, 50 & 150mm Extensions, Universal Joint, Socket Driver, Bit Holder
- 1/4" Drive Standard Sockets: Metric: 4, 4.5, 5, 5.5, 6, 7, 8, 9, 10mm A/F: 3/16, 7/32, 1/4, 9/32, 5/16, 11/32, 3/8"
- 152mm Diagonal Cutting Pliers
- 152mm Long Nose Pliers
- 178mm Combination Pliers
- 33 Assorted 1/4" Bits, Screwdriver, Hex & Torx®
- Adjustable Wrench: 300mm
- Combination Spanners: Metric: 8, 9, 10, 11, 12, 13, 14, 15, 16, 17, 18, 19mm A/F: 3/8, 7/16, 1/2, 9/16, 5/8, 11/16, 3/4"
- Hex Key Set – Long Ball Type: 1.5, 2, 2.5, 3, 4, 5, 6, 8, 10mm
- Screwdrivers: Slotted 5x100mm, 6x150mm Phillips® #1x100mm, #2x150mm



120 PC MASTER SET



PART No.	DESCRIPTION	PBQ
91-931	120 PC MASTER SET	1

- 10 Pc 1/4 DRIVE SOCKET 6 POINT: 5/32, 3/16, 7/32, 1/4, 9/32, 5/16, 11/32, 3/8, 7/16, 1/2
- 12 Pc 1/4 DRIVE SOCKET 6 POINT: 4, 5, 5.5, 6, 6.5, 7, 8, 9, 10, 11, 12, 13mm
- 4 Pc 1/4 DRIVE DEEP SOCKET 6 POINT: 8,9, 10, 12mm
- 11 Pc 3/8 DRIVE SOCKET 6 POINT: 9, 10, 11, 12, 13, 14, 15, 16, 17, 18, 19mm
- 9 Pc 3/8 DRIVE SOCKET 6 POINT: 3/8, 7/16, 1/2, 9/16, 5/8, 11/16, 3/4,13/16, 7/8
- 4 Pc 3/8 DRIVE DEEP SOCKET 6 POINT: 13, 14, 15, 17mm
- 7 Pc 1/2 DRIVE SOCKET 6 POINT: 20, 21, 22, 24, 27, 30, 32mm
- 8 Pc 3/8 DRIVE TORX® SOCKET: E8, E10, E11, E12, E14, E16, E18, E20
- 4 Pc 1/2 DRIVE SOCKET 6 POINT: 15/16, 1, 1-1/16, 1-1/4
- 4 Pc 1/2 DRIVE IMPACT SOCKET 6 POINT: 14, 19, 21, 23mm
- 2 Pc 3/8 DRIVE SPARK PLUG SOCKET 6 POINT: 16, 21mm
- 7 Pc 3/8 DRIVE TORX® (HOLE) BITS: T10, T15, T20, T25, T27, T30, T40
- 17 Pc 3/8 DRIVE 6 POINT BIT SOCKETS: TORX®: T20, T30, T40, T45, T50, T55, T60
HEX: 3 4 5 6mm, PHILLIPS®: 1Pt, 2Pt, POZIDRIV®: 1Pt 2Pt, SLOTTED: 5.5,6.5mm
- 3 Pc UNIVERSAL JOINT: 1/4, 3/8, 1/2
- 1 Pc 1/4 DRIVE BIT ADAPTER: 1/4
- 1 Pc 1/4 DRIVE SPINNER
- 1 Pc 1/4 DRIVE EXTENSION BAR: 2 (50mm)
- 2 Pc 3/8 DRIVE EXTENSION BAR: 3, 10 (75, 250mm)
- 2 Pc 1/2 DRIVE EXTENSION BAR: 5, 10 (125, 250mm)
- 3 Pc PEAR HEAD RACHET: 1/4, 3/8, 1/2
- 10 Pc FULL POLISH LONG PANEL COMBINATION WRENCHES: 9,10,11,12,13,14, 17,18, 19mm



86 PC 1/4" & 1/2" DRIVE 6 POINT METRIC SOCKET SET



PART No.	DESCRIPTION	PBQ
94-190	86Pc 1/4 & 1/2 Sq.dr. Metric Socket Set-6pt	1

- 14 Pc 1/4 DRIVE 6 POINT METRIC SOCKET: 3.5,4,4.5,5,5.5,6,7,8,9,10,11,12,13,14mm
- 8 Pc 1/4 DRIVE 6 POINT METRIC DEEP SOCKETS: 6, 7, 8, 9, 10, 11, 12, 13mm
- 2 Pc 1/4 & 1/2 DRIVE PEAR HEAD RACHET WITH COMFORT GRIP
- 2 Pc 1/4 DRIVE EXTENSION BAR: 2, 4 (50, 100mm)
- 1 Pc 1/4 SLIDING T-BAR: 4 (100mm)
- 1 Pc 1/4 DRIVE BIT SPINNER
- 1 Pc 1/4 DRIVE UNIVERSAL JOINT
- 1 Pc 3/8 DRIVE FEMALE & 1/2 DRIVE MALE: 3-WAY ADAPTER
- 14 Pc 1/2 DRIVE 6 POINT METRIC SOCKETS: 13,15,16,17,18,19,20,21,22,23,24,27,30, 32mm
- 4 Pc 1/2 DRIVE 6 POINT DEEP METRIC SOCKETS: 14, 16, 17, 19mm
- 2 Pc 1/2 DRIVE EXTENSION BAR: 5, 10 (125, 250mm)
- 1 Pc 1/2 DRIVE UNIVERSAL JOINT,
- 1 Pc 1/2 DRIVE BIT HOLDER: 5/16
- 2 Pc 1/2 DRIVE 6 POINT SPARK PLUG METRIC SOCKETS: 16, 21mm
- 6 Pc 1/4 DRIVE TORX® BIT SOCKETS: T-8, T-10, T-15, T-20, T-25, T-30
- 4 Pc 1/4 DRIVE HEX BIT SOCKETS: 3, 4, 5, 6mm
- 2 Pc 1/4 DRIVE PHILLIPS® BIT SOCKETS: #1, #2
- 2 Pc 1/4 DRIVE POZIDRIV® BIT SOCKET: #1, #2
- 3 Pc 1/4 DRIVE SLOTTED BIT SOCKETS: 4, 5.5, 6.5mm
- 3 Pc 5/16 DRIVE SLOTTED®: 8, 10, 12mm
- 2 Pc 5/16 DRIVE PHILLIPS® BIT: #3, #4
- 2 Pc 5/16 DRIVE POZIDRIV® BIT: #3, #4
- 4 Pc 5/16 Drive Torx® Bit with Rubber Holder: T-40, T-45, T-50, T-55
- 4 Pc 5/16 Drive Hex Bits: 8, 10, 12, 14mm



35 PC 1/4" DRIVE 6 POINT SOCKET & BIT SET



PART No.	DESCRIPTION	PBQ
1-89-033	35 Pc 1/4" Drive 6 Point Socket & Bit Set	1

- 13 Pc 1/4 Drive 6 Point Sockets: 4, 4.5, 5, 5.5, 6, 7, 8, 9, 10, 11, 12, 13, 14mm
- 1 Pc Spinner Handle,
- 2 Pc Extensions: 75, 150mm,
- 1 Pc Universal Joint,
- 1 Pc "Professional" Ratchet,
- 1 Pc Hex Bit Holder
- 4 Pc Hex Bit: 3, 4, 5, 6mm,
- 6 Pc Torx® Bits: T-10, T-15, T-20, T-25, T-30, T-40
- 3 Pc Posidrive® Bits: 1, 2, 3
- 3 Pc Slotted Bits: 4, 5.5, 6.5



46 PCS 1/4" DRIVE METRIC SOCKET SET



PART No.	DESCRIPTION	PBQ
STMT72794-8	46 Pc 1/4 Drive Metric Socket Set	1

- 1Pc 1/4 Drive Quick Release Ratchet
- 2Pc 1/4 Drive Extensions: 50 And 100mm
- 1Pc 1/4 Drive Flexible Extension
- 1Pc 1/4 Drive Universal Joint
- 1Pc 1/4 Drive Sliding T-bar
- 1Pc 1/4 Drive Spinner Handle
- 4Pc 1/4 Hex Keys 1.5, 2, 2.5, 3mm
- 22Pc 1/4 Drive Bit Sockets - Hex 3, 4, 5, 6, 7, 8mm
Torx® T8, T10, T15, T20, T25, T30, T40 Phillips® 1pt, 2pt, 3pt
Pozidrive® 1, 2, 3 Slotted - 4, 5, 5.7mm
- 13pc 1/4 Drive 6 Point Socket 4, 4.5, 5, 5.5, 6, 7, 8, 9, 10, 11, 12, 13, 14mm



24 PC 3/8" DRIVE METRIC SOCKET SET



PART No.	DESCRIPTION	PBQ
1-89-035	24 Pc 3/8" Drive Metric Socket Set	1

- 19 Pc 3/8 Drive 6 Point Sockets: 6, 7, 8, 9, 10, 11, 12, 13, 14, 15, 16, 17, 18, 19, 20, 21, 22, 23, 24mm
- 5 Pc 3/8 Drive Accessories:
Extensions: 75, 150mm,
Universal Joint,
Sliding T-bar
Professional Ratchet



46 PC 1/4" & 3/8" DRIVE SOCKET & BIT SET



PART No.	DESCRIPTION	PBQ
89-516	46 Pc 1/4" & 3/8" Drive Socket & Bit Set	1

- 7 Pc 3/8 Drive 12point Sockets: 3/8, 7/16, 1/2, 9/16, 5/8, 11/16, 3/4
- 12 Pc 3/8 Drive 12 Point Sockets: Metric- 8,9,10,11,12,13,14,15,16,17,18,19mm
- 9 Pc 1/4 Drive Bit Set: Pozidriv Bit-1,2,3mm & Hex Bit-3,4,5,6,7,8mm
- 9 Pc 1/4 Drive Bit Set: Slotted Bits - 4,5,6.5 & Torx® Bits - T10,t15,t20,t25, T30,t40
- 9 Pc 3/8 Drive Accessories: 2 Pc. Spark Plug Socket, 6 Point Socket: 5/8 & 13/16 , 2 Pc Extension Bar-75& 150mm , 1 Pc Universal Joint, 1 Pc Adapter, 1 Pc Full Polish Quick Release Ratchet, 1 Pc 1/4 Drive Bit Adapter 1/4 Drive Spinner Handle



43 PC 1/2" DRIVE 12 POINT SOCKET SET



PART No.	DESCRIPTION	PBQ
89-509	43pc 1/2 Drive 12 Point Socket Set	1

- 15 Pc 1/2 Drive 12 Point Sockets: 3/16, 7/16, 1/2, 9/16, 1-1/16, 5/8, 11/16, 3/4, 13/16, 7/8, 15/16, 1, 1-1/8, 1-3/16, 1-1/4
- 20 Pc 1/2 Drive 12 Point Sockets: Metric-10,11,12,13,14,15,16,17,18,19,20, 21,22,23,24,26,27,28,30,32mm
- 8 Pc 1/2 Drive Accessories: 2 Pc 6 Point Spark Plug Socket: 5/8 & 13/16, Universal Joint, 1 Pc Flex Handle-375mm, 3 Extension Bars - 3,5 & 10 (75, 125, 250mm), 1 Pc Full Polish Quick Release Ratchet



26 PC 1/2" DRIVE METRIC 12 POINT SOCKET SET



PART No.	DESCRIPTION	PBQ
86-477	SOCKET SET 1/2 SQ. DR 27PC-12PT MET	1

- 20 PC 1/2 DRIVE 12 POINT SOCKETS: 10,11,12,13,14,15,16,17,18,19,20, 21, 22, 23, 24, 25, 26, 27, 30, 32MM
- 6 PC 1/2 DRIVE ACCESSORIES: 2 PC EXTENSION BAR: 5 & 10(125 & 250MM) UNIVERSAL JOINT, 1 PC SPARK PLUG SOCKET 6 POINT 13/16, 1 PC SLIDING T-BAR 10(254MM), 1 PC FLIP-DRIVE RACHET



26 PC 1/2" DRIVE 12 POINT SOCKET SET



PART No.	DESCRIPTION	PBQ
86-478	26 Pc 1/2 Drive 12 Point Socket Set	1

20 Pc 1/2 Drive 12 Point Sockets: 1/4, 5/16, 3/8, 7/16, 1/2, 9/16, 19/32, 5/8, 11/16, 3/4, 25/32, 13/16, 7/8, 15/16, 31/32, 1, 1-1/16, 1-1/8, 1-3/16, 1-1/4
 6 Pc 1/2 Drive Accessories: 2 Extension Bar: 5 & 10(125, 250mm), 1pc Universal Joint, 1 Pc Spark Plug Socket 6 Point 13/16, 1 Sliding T-bar 10(254mm), 1 Pc Flip-drive Ratchet



24 PCS 1/2" DRIVE SOCKET SET

PART No.	DESCRIPTION	PBQ
STMT72795-8	24 Pcs 1/2" Drive Socket Set	1

1pc 1/2 Drive Quick Release Ratchet
 2pc 1/2 Drive Extensions : 130 & 250mm
 1pc 1/2 Drive Universal Joint
 1pc 1/2 Drive Sliding T-handle
 1pc 1/2 Drive Spark Plug Sockets 21mm
 18 Pc 1/2 Drive 6 Point Socket - 10, 11, 12, 13, 14, 15, 16, 17, 18, 19, 20, 21, 22, 23, 24, 27, 30, 32mm



9 PC 1/2" DRIVE TORX® BIT SOCKET SET



PART No.	DESCRIPTION	PBQ
89-098	9 Pc 1/2 Drive Torx® Bit Socket Set-Metric-T-20, T-25, T-27, T-30, T-40, T-45, T-50, T-55, T-60	1



7PC 1/2" DRIVE HEX BIT METRIC SOCKET SET



PART No.	DESCRIPTION	PBQ
1-89-099	7 Pc 1/2 Drive Hex Bit Sockets: 6,8,10,12,14,17,19mm	1



19 PC 3/4" DRIVE METRIC 12 POINT SOCKET SET



PART No.	DESCRIPTION	PBQ
89-101-12	19 Pc 3/4" Drive Metric 12 Point Socket Set	1

- 13 Pc 3/4 Drive 12 Point Sockets: 22, 24, 27, 28, 29, 30, 32, 33, 34, 36, 38, 41, 42, 46, 50mm
- 4 Pc 3/4 Drive Accessories: 2 Pc Extension Bar: 200 & 400mm
Sliding T-bar 480mm
Standard Ratchet



53 PCS TELECOMMUNICATION SET



PART No.	DESCRIPTION - CONTENTS	PBQ
STHT89883-812	53 Pcs Telecommunication Tool Set	1

- 1 Pc Standard Digital Multi Meter
- 8 Pc Cushion Grip Screwdrivers: Ph1*75mm&150mm, Ph2*45mm&100mm
Sl3*75mm&150mm, Sl6.5*40mm&100mm
- 1 Pc Utility Knife
- 1 Pc 6" Long Nose Pliers
- 1 Pc 8" linesman Pliers
- 1 Pc Mini-hacksaw
- 1 Pc 10" adjustable Wrench
- 1 Pc 9" wire Stripper
- 10 Pc Hex Key: 1.5, 2, 2.5, 3, 4, 5, 5.5, 6, 8, 10mm
- 1 Pc Spinner Handle
- 1 Pc 1/4" dr. Drive Adaptor
- 13 Pc 1/4" dr. Drive 6 Point Sockets: 4, 4.5, 5, 5.5, 6, 7, 8, 9, 10, 11, 12, 13, 14mm
- 6 Pc Precision Screwdriver Set: Opt, 1pt, 1.4mm, 2.0mm, 2.4mm, 3.0mm
- 1 Pc Soldering Iron 40w / 220v
- 1 Pc Solder
- 1 Pc Desoldering Pump 94-380
- 1 Pc Digital Spark Tester
- 1 Pc Tweezers
- 1 Pc Measuring Tape - 3 M
- 1 Pc Plastic Box

AVT100A

EVT600A

EVT3000A

HVT5000

GVT8400



**BRITTOOL 3/8, 1/2, 3/4 & 1 SQUARE DRIVE
STANLEY RATCHETING TYPE 3/8 & 1/2 DRIVE
Torque Wrenches**



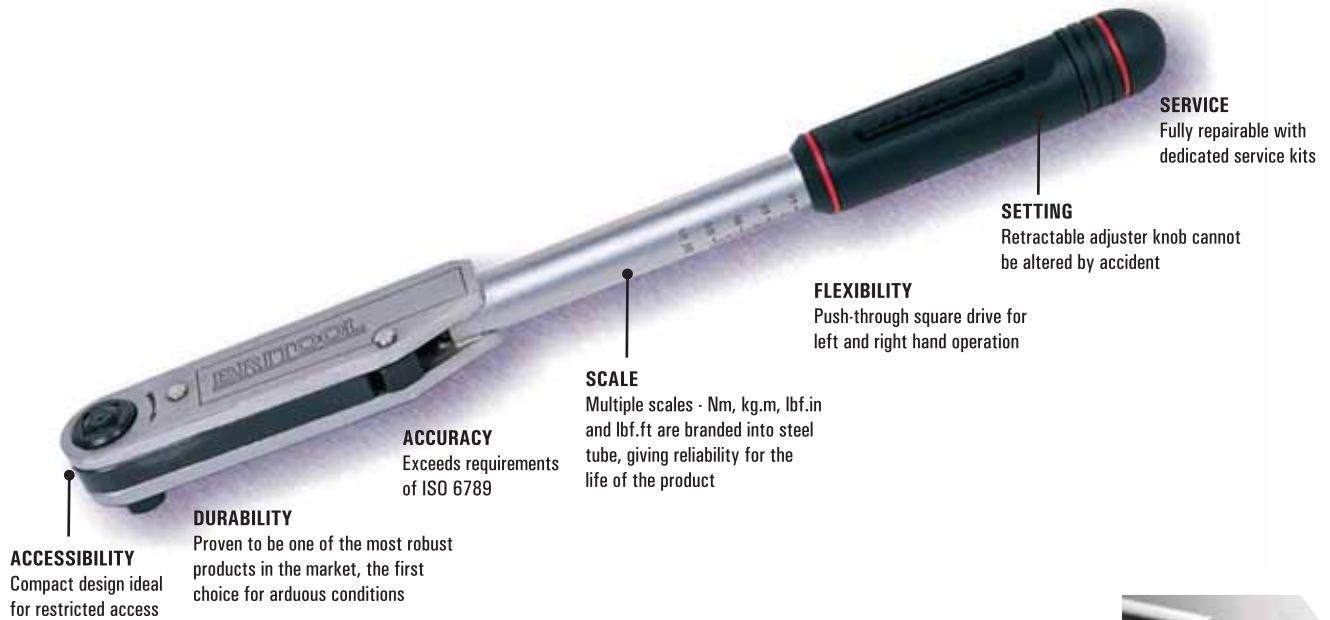

Convert 10 ft.lb to N.m, 10ft.lb x 1.35 = 13.5 N.m

Torque Measurement Conversion Chart

TO CONVERT FROM	TO CONVERT TO								
	mN.m	cN.m	N.m	daN.m	cm.kg	m.kg	in.oz	in.lb	ft.lb
	millinewton metre	centinewton metre	newton metre	decanewton metre	centimetre kg	metre kg	inch-ounce	inch-pound	foot-pound
1mN.m	1	0.1	0.001	0.0001	0.0102	0.000102	0.1418	0.00886	0.000738
1cN.m	10	1	0.01	0.001	0.102	0.00102	1.418	0.0886	0.00738
1N.m	1000	100	1	0.1	10.2	0.102	141.8	8.863	0.738
1daN.m	10000	1000	10	1	10.2	1.02	1418	88.63	7.38
1cm.kg	98	9.8	0.098	0.0098	1	0.01	13.9	0.869	0.0724
1m.kg	9810	981	9.81	0.98	100	1	1390	86.90	7.24
1in.oz	7.05	0.705	0.00705	0.0007	0.072	0.0072	1	0.063	0.0052
1in.lb	112.8	11.28	0.1128	0.01128	1.152	1.0115	16	1	0.083
1ft.lb	1350	135	1.35	0.135	13.8	0.138	192	12	1

TORQUE WRENCHES

TORQUE WRENCHES- 3/8 CLASSIC



PART No.	DESCRIPTION	TORQUE RANGE	LENGTH	PBQ
AVT100A	3/8 Sq. Dr. Torque Wrench	2.5-11nm	318mm	1
AVT300A	3/8 Sq. Dr. Torque Wrench	5-33nm	422mm	1

TORQUE WRENCHES- 1/2 CLASSIC



PART No.	DESCRIPTION	TORQUE RANGE	LENGTH	PBQ
EVT600A	1/2 Sq. Dr. Torque Wrench	12-68nm	476mm	1
EVT1200A	1/2 Sq. Dr. Torque Wrench	25-135nm	546mm	1
EVT2000A	1/2 Sq. Dr. Torque Wrench	50-225nm	597mm	1
EVT3000A	1/2 Sq. Dr. Torque Wrench	70-330nm	825mm	1

TORQUE WRENCHES- 3/4 & 1 CLASSIC



PART No.	DESCRIPTION	TORQUE RANGE	LENGTH	PBQ
HVT5000	3/4 Sq. Dr. Torque Wrench	140-560nm	1130mm	1
HVT7200	3/4 Sq. Dr. Torque Wrench	200-810nm	1181mm	1
GVT8400	1 Sq. Dr. Torque Wrench	480-940nm	1397mm	1

POWER WITH PRECISION

VERSATILE AND ACCURATE

Quality manufactured with Chrome Vanadium, STANLEY® TORQUE wrenches provide top level of accuracy with easy to use features.

The Chrome - Molybdenum drives and locking pawl are built to withstand heavy use in the workshop.

Clear, dual scale engraved markings are easy to read and the knurled ring provides rapid torque setting adjustment. Designed for left or right rotations with audible click it's easy to get the job torqued up correctly.

The range includes in 1/4", 3/8", 1/2" and 3/4" drive options and covers torques from 5 up to 750Nm - broad enough for a wide range of professional applications.

Every Torque wrench features a unique serial number for complete traceability and comes complete with a calibration certificate in blow molded case.

CERTIFIED PERFORMANCE

Tested to extremes, the STANLEY® Torque wrench range complies with ISO 6789 & ASME B107.14 - giving a consistent result and professional performance every time.

Accuracy - +/- 4%

Reliability - tested over 20,000 click cycles

Load Tested - 25% above load capacity



STANLEY		Stanley Black & Decker					
Certificate of Calibration		Tel: +886 4 25606521 Fax: +886 4 25606528 www.stanleyblackanddecker.com					
Model:	5-25 N-m	Tolerance:	± 1%				
Serial No:	311112000001	Units:	N/m				
Maximum Capacity:	25	Ambient Temperature:	20°C				
Inspector:	Lia						
Set Torque	Min	Max	Actual Readings				
5	4.8	5.2	5	4.99	5.014	5.02	5.02
15	14.4	15.6	15.21	15.18	15.18	15.09	15.1
25	24	26	25.31	25.3	25.22	25.24	25.3
<small>The limits shown on this test equipment comply with the requirements of ISO 6789:2005. The uncertainty of the test equipment used is ±1%. The test equipment used in the performance of the above calibration has international traceability through:</small>							
Tester model:	Yukon Model No. 43219	Date of Calibration:					
Serial No. 1:	98195	Inspector:					
Labatory No. 1:	EKAS 0255	Quality Manager:					



ISO Accreditation by independent organization made up of members from the national standards bodies of 164 countries.



ANSI American National Standards Institute



Audible Indicator for precision tightening



Dual Scale Easy to read Nm / lb-ft markings

GETTING THE BEST OUT OF A TORQUE WRENCH

INFORMATION & ADVICE

As a precision instrument, the STANLEY® Torque wrench range is designed along best practice principles. To preserve the set calibration, the tool should be reset to 10% of the maximum capable load after each use. In order to provide a secure fastening without the risk of distortion, it is important to follow correct tightening sequences.

IMPORTANT: Torque specifications vary widely, always refer to the manufacturer's recommendation. The star pattern sequence should be used until all of the fasteners are tightened to the specified torque.

RADIAL APPLICATIONS

For wheels and other radial applications it is important to tighten the fasteners following the traditional star pattern sequence shown in the diagram on the right.

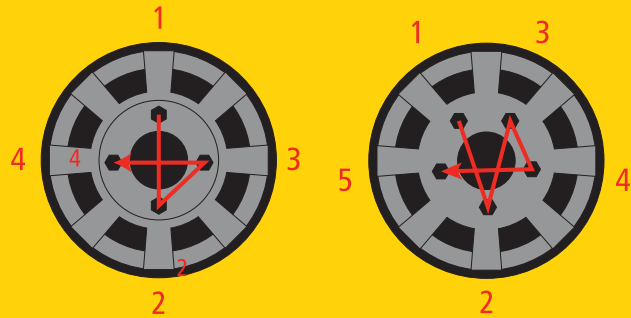

CYLINDER HEAD APPLICATIONS

Always start in the middle of the engine, between cylinders 2 and 3 for a cylinder engine. Move outwards in a spiral or crosswise outward direction along both sides. Tighten gradually, increasing the torque in stages on each fastener to ensure an even clamping force, until the outer bolts on Cylinders 1 and 4 have been tightened.

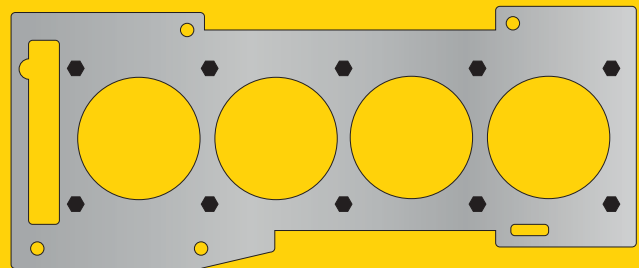

FORMULA FOR CALCULATING THE EFFECT OF TORQUE WRENCH EXTENSIONS

In cases whereby special attachments change the calibration of the Torque wrench or when it is impractical to use regular sockets (such as whilst tightening threaded connectors), it is necessary to calculate the accurate settings using the formulas shown in the diagram opposite:

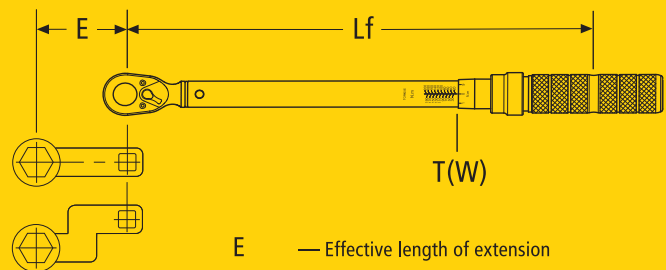

- E — Effective length of extension
- Lf — Lever length of the wrench: middle of handle to center of square drive
- T(W) — Torque setting on the wrench
- T(A) — Torque applied by the extension to the fastener
- T(A) — $T(W) \times \frac{L_f + E}{L_f}$

TORQUE WRENCH COMPARATOR



SKU #	Description	Drive Size	Torque Range		Increments N-m	Width (mm)	Length (mm)	Weight (kg)
STMT73587-8	1/4" TORQUE WRENCH 5-25 Nm	1/4"	5 - 25N-m	39.8-225.7 in-lb	0.1 N-m	22.5	246	0.365
STMT73588-8	3/8" TORQUE WRENCH 10-50Nm	3/8"	10 - 50N-m	9.2-38.7 ft-lb	0.5 N-m	31	409	1.182
STMT73589-8	1/2" TORQUE WRENCH 20-100Nm	1/2"	20 - 100N-m	16.6-75.6 ft-lb	0.5 N-m	31	409	1.19
STMT73590-8	1/2" TORQUE WRENCH 40-200Nm	1/2"	40 - 200N-m	33.2-151.2 ft-lb	1 N-m	41	519	1.6
STMT73591-8	1/2" TORQUE WRENCH 60-340Nm	1/2"	60 - 340N-m	51.6-258.1 ft-lb	2 N-m	41	610	1.785
STMT73592-8	3/4" TORQUE WRENCH 150-750Nm	3/4"	150 -750N-m	110-550 ft-lb	2.5 N-m	58	1112	5.87

CONSISTENT PERFORMANCE, +/- 4% ACCURACY EVEN AFTER 20,000 CYCLES

Robust build quality and precision manufacturing ensures STANLEY® Torque wrenches meet and beat current standards, delivering reliability, day after day - year after year.

RELIABILITY OF MECHANISM

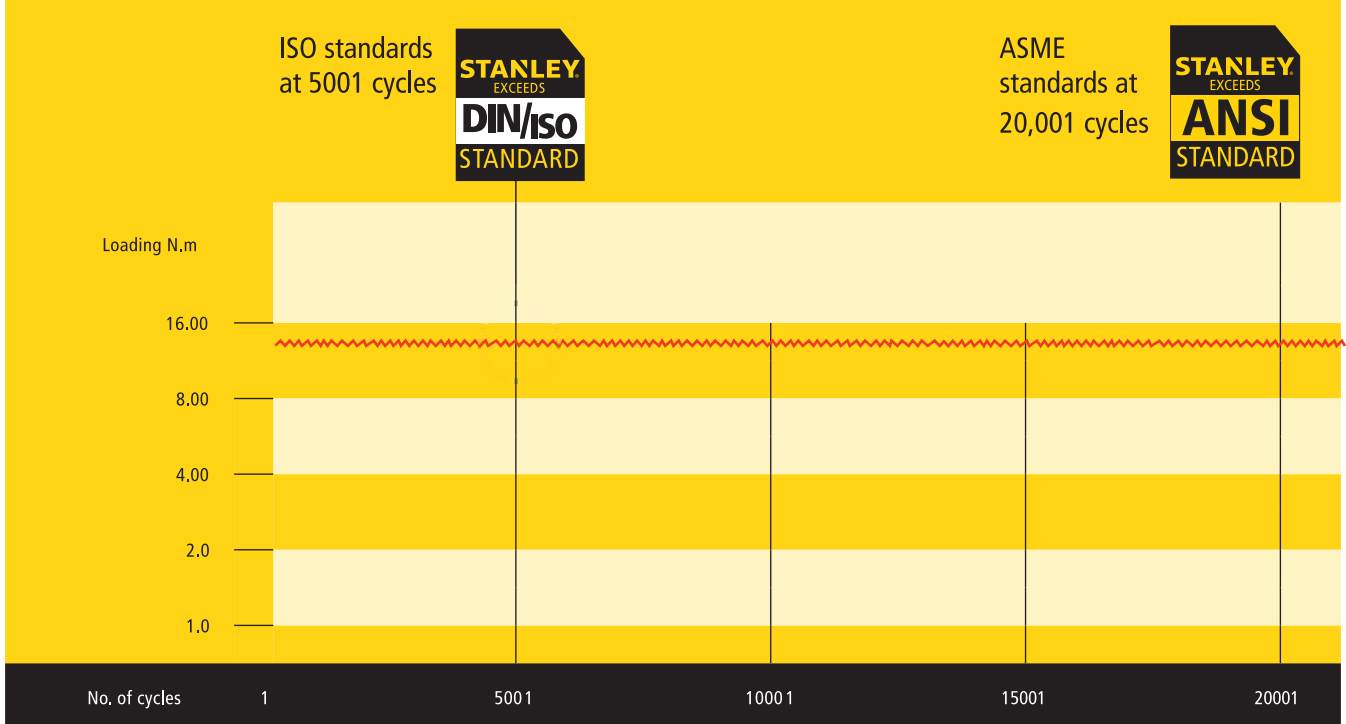

Test carried out using 1/4" drive, 5 - 25N.m 50% loading



TORQUE CONTROL GUIDE



Tightening torque and tensile load

- Application of the correct force (tensile load) is essential for a reliable assembly :
 - under-tight fasteners can work loose.
 - over-tight fasteners may distort components to be connected or shear the fastener.
- Tensile load depends on tightening torque applied to the fastener and the friction coefficient.

Tensile load (Fo)

The force in Newtons (N) which maintains pressure contact between assembled components.

Tightening torque (Cs)

The product of a force and the leverage length at which it is applied : Torque (N.m) = Force (in Newtons) x length (in metres).

Tightening torque table :

Torque values are given for 85 % fastener yield strength (documentation E 25-030).

1. Friction coefficient

Choose the appropriate table according to type of fasteners used (0.10, 0.15, or 0.20).

Example : $\mu = 0.10$.

2. Fastener grade

The grade of a fastener denotes its quality (best is 12.9).

Check the appropriate column for the fasteners used.

Example : fastener dia. 10, fastener grade 8.8

3. Tightening torque (Cs).

Torque values are listed in Newton-meters (Nm) for each type of fastener. In the example given, the fastener would be tightened to a torque of 36 Nm.

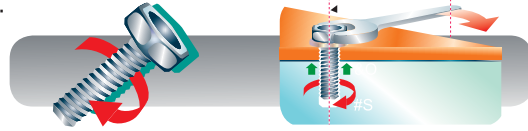

CONVERSION TABLE

The Internationally accepted unit is the Newton-meter (Nm)

1. To convert Nm

- Newton-metres to Kilogramme-force metres : 1 Nm = 0.102 kgf.m
- Newton-metres to Pound-force feet : 1 Nm = 0.738 lbf.ft
- Newton-metres to Pound-force inches : 1 Nm = 8.851 lbf.in
- Newton-metres to Ounce-force inches : 1 Nm = 141.61 ozf.in

2. To convert kgf.m

- Kilogramme-force metres to Newton-metres : 1 kgf.m = 9.81 Nm
- Kilogramme-force metres to Pound-force feet : 1 kgf.m = 7.23 lbf.ft
- Kilogramme-force metres to Pound-force inches : 1 kgf.m = 86.8 lbf.in

3. To convert lbf.ft

- Pound-force feet en Newton-metres : 1 lbf.ft = 1.35 Nm
- Pound-force feet to Kilogramme-force metres : 1 lbf.ft = 0.138 kgf.m
- Pound-force feet to Pound-force inches : 1 lbf.ft = 12 lbf.in

4. To convert lbf.in

- Pound-force inches to Newton-metres : 1 lbf.in = 0.1129 Nm
- Pound-force inches to Kilogramme-force metres : 1 lbf.in = 0.0115 kgf.m
- Pound-force inches to Pound-force feet : 1 lbf.in = 0.083 lbf.ft
- Pound-force inches to Ounce-force inches : 1 lbf.in = 16 ozf.in

m = 0.10 tightening torques for phosphated or galvanised fasteners with full lubrication (m = average friction coefficient)

hrm QVQ			Steel fastener grades to ISO 898-1															
d mm	ISO mm	mm	5,6		5,8		6,8		8,8		9,8 **		10,9		12,9			
			Cs	Fo	Cs	Fo	Cs	Fo	Cs	Fo	Cs	Fo	Cs	Fo	Cs	Fo		
1,6**	0,35	3,2	0,060	260	0,084	364	0,096	416	0,128	555	0,144	624	0,189	815	0,221	954		
2**	0,40	4	0,126	432	0,177	604	0,202	690	0,270	921	0,303	1 036	0,396	1 352	0,463	1 582		
2,5**	0,45	5	0,261	718	0,365	1 006	0,417	1 150	0,556	1 533	0,626	1 724	0,82	2 251	0,96	2 634		
3	0,50	5,5	0,44	1 077	0,62	1 508	0,71	1 724	0,95	2 298	1,09	2 586	1,40	3 376	1,64	3 951		
4	0,70	7	1,03	1 868	1,44	2 615	1,65	2 988	2,20	3 985	2,49	4 484	3,23	5 853	3,78	6 849		
5	0,80	8	2,03	3 053	2,85	4 275	3,25	4 885	4,34	6 514	4,92	7 335	6,3	9 568	7,4	11 196		
6	1	10	3,53	4 310	4,95	6 034	5,6	6 896	7,5	9 195	8,53	10 336	11	13 506	12,9	15 805		
8	1,25	13	8,5	7 904	11,9	11 066	13,6	12 647	18,2	16 863	20,63	18 968	26	24 768	31	28 984		
10	1,50	16	16,8	12 580	23	17 612	27	20 128	36	26 838	41	30 197	52	39 418	61	46 128		
12	1,75	18	29	18 337	40	25 672	46	29 339	62	39 119	70	44 022	91	57 457	106	67 236		
14	2	21	46	25 175	65	35 245	74	40 280	99	53 707	111	60 251	145	78 882	170	92 309		
16	2	24	71	34 597	100	48 436	115	55 356	153	73 808	173	83 165	225	108 406	263	126 858		
18	2,5	27	99	42 094	139	58 932	159	67 351	220	92 440			313	131 897	366	154 348		
20	2,5	30	140	54 059	196	75 682	225	86 494	311	119 003			440	169 385	515	198 216		
22	2,5	34	192	67 511	269	94 515	307	108 017	424	148 374			602	211 534	704	247 540		
24	3	36	241	77 845	338	108 983	387	124 552	534	171 437			758	243 914	887	285 432		
27	3	41	355	102 393	498	143 350	569	163 829	784	225 110			1 114	320 832	1 304	375 442		
30	3,5	46	483	124 491	677	174 287	773	199 185	1 067	274 030			1 515	390 072	1 773	456 467		
33	3,5	50	653	155 083	915	217 116	1 046	248 132	1 442	341 347			2 048	485 926	2 397	568 637		
36	4	55	841	182 032	1 177	254 845	1 346	291 252	1 855	400 571			2 636	570 369	3 085	667 453		
39	4	60	1 088	218 667	1 523	306 135	1 741	349 868	2 399	481 158			3 410	685 159	3 990	801 782		
42**	4,5	65	1 348	250 311	1 887	350 435	2 156	400 497	2 965	550 683			4 223	784 306	4 941	917 805		
45**	4,5	70	1 681	292 970	2 353	410 158	2 690	468 752	3 698	644 534			5 267	917 973	6 164	1 074 223		
48**	5	75	2 032	329 254	2 845	460 956	3 251	526 807	4 470	724 359			6 367	1 031 663	7 450	1 207 265		
52**	5	80	2 608	395 006	3 651	553 008	4 172	632 009	5 737	869 013			8 171	1 237 685	9 562	1 448 354		
56**	5,5	85	3 255	456 159	4 557	638 622	5 208	729 854	7 161	1 003 549			10 199	1 429 298	11 935	1 672 582		
60**	5,5	90	4 032	532 893	5 645	746 050	6 451	852 629	8 871	1 172 365			12 634	1 669 732	14 785	1 953 941		
64**	6	95	4 856	602 793	6 798	843 911	7 769	964 470	10 683	1 326 146			15 215	1 888 753	17 805	2 210 243		

Grade 8-8a up to d=16 mm, 8-8b above d=118 mm



TORQUE CONTROL GUIDE



m = 0.15 tightening torques for coated or bright fasteners fitted dry (m = average friction coefficient)

d mm	ISO mm	mm	5,6		5,8		6,8		8,8		9,8		10,9		12,9	
			Cs	Fo	Cs	Fo	Cs	Fo	Cs	Fo	Cs	Fo	Cs	Fo	Cs	Fo
1,6**	0,35	3,2	0,075	234	0,105	327	0,120	374	0,160	499	0,180	561	0,235	732	0,275	857
2**	0,40	4	0,159	388	0,222	544	0,254	621	0,339	829	0,381	932	0,498	1 217	0,582	1 424
2,5**	0,45	5	0,330	648	0,463	907	0,529	1 036	0,705	1 382	0,793	1 555	1,04	2 030	1,21	2 375
3	0,50	5,5	0,57	972	0,80	1 362	0,91	1 556	1,21	2 075	1,38	2 335	1,79	3 048	2,09	3 567
4	0,70	7	1,30	1 685	1,83	2 359	2,09	2 696	2,78	3 594	3,16	4 044	4,09	5 279	4,79	6 178
5	0,80	8	2,59	2 759	3,62	3 862	4,14	4 414	5,5	5 886	6,27	6 626	8,1	8 645	9,5	10 116
6	1	10	4,49	3 891	6,2	5 448	7,1	6 226	9,5	8 302	10,84	9 334	14,0	12 194	16,4	14 269
8	1,25	13	10,9	7 145	15,2	10 003	17,4	11 432	23	15 242	26,34	17 146	34	22 388	40	26 198
10	1,50	16	21	11 379	30	15 930	34	18 206	46	24 275	52	27 313	67	35 655	79	41 724
12	1,75	18	37	16 594	52	23 231	59	26 550	79	35 401	90	39 835	116	51 995	136	60 845
14	2	21	59	22 789	83	31 905	95	36 463	127	48 618	143	54 570	187	71 408	219	83 563
16	2	24	93	31 385	130	43 939	148	50 216	198	66 955	224	75 422	291	98 340	341	115 079
18	2,5	27	128	38 123	179	53 373	205	60 998	283	83 746			402	119 454	471	139 787
20	2,5	30	182	49 039	254	68 655	291	78 463	402	107 941			570	153 657	667	179 811
22	2,5	34	250	61 326	350	85 857	400	98 123	552	134 806			783	192 157	917	224 865
24	3	36	313	70 616	438	98 863	500	112 986	691	155 489			981	221 266	1 148	258 928
27	3	41	463	93 042	649	130 259	741	148 868	1 022	204 577			1 452	291 534	1 700	341 157
30	3,5	46	628	113 045	880	158 263	1 005	180 872	1 387	248 811			1 969	354 209	2 305	414 500
33	3,5	50	854	141 009	1 195	197 412	1 366	225 614	1 884	310 343			2 676	441 828	3 132	517 033
36	4	55	1 096	165 409	1 534	231 573	1 754	264 655	2 418	363 974			3 435	518 282	4 020	606 501
39	4	60	1 424	198 910	1 994	278 474	2 279	318 257	3 139	437 669			4 463	623 253	5 223	729 339
42**	4,5	65	1 760	227 588	2 464	318 624	2 816	364 141	3 872	500 694			5 515	713 110	6 453	834 491
45**	4,5	70	2 203	266 613	3 085	373 258	3 525	426 580	4 847	586 548			6 903	835 386	8 079	977 579
48**	5	75	2 659	299 530	3 722	419 342	4 254	479 248	5 849	658 966			8 330	938 528	9 748	1 098 277
52**	5	80	3 425	359 684	4 795	503 558	5 480	575 495	7 335	791 306			10 731	1 127 011	12 558	1 318 843
56**	5,5	85	4 270	415 172	5 978	581 240	6 832	664 275	9 394	913 378			13 379	1 300 871	15 656	1 522 296
60**	5,5	90	5 306	485 416	7 428	679 583	8 490	776 666	11 673	1 067 916			16 625	1 520 971	19 455	1 779 860
64**	6	95	6 382	548 969	8 935	768 556	10 212	878 350	14 041	1 207 731			19 998	1 720 102	23 402	2 012 885

m = 0.20 tightening torques for black or galvanised fasteners with minimal lubrication (as supplied)
(m = AVERAGE friction coefficient)

d mm	ISO mm	mm	5,6		5,8		6,8		8,8		9,8		10,9		12,9	
			Cs	Fo	Cs	Fo	Cs	Fo	Cs	Fo	Cs	Fo	Cs	Fo	Cs	Fo
1,6**	0,35	3,2	0,086	210	0,120	294	0,137	335	0,183	447	0,206	503	0,269	657	0,315	769
2**	0,40	4	0,183	349	0,256	488	0,293	558	0,390	744	0,439	837	0,573	1 093	0,671	1 279
2,5**	0,45	5	0,383	582	0,536	815	0,612	931	0,816	1 242	0,918	1 397	1,20	1 824	1,40	2 134
3	0,50	5,5	0,66	874	0,92	1 224	1,06	1 399	1,41	1 866	1,60	2 099	2,07	2 740	2,43	3 207
4	0,70	7	1,51	1 514	2,11	2 120	2,42	2 422	3,22	3 230	3,66	3 635	4,74	4 744	5,5	5 552
5	0,80	8	3,00	2 481	4,20	3 473	4,81	3 970	6,4	5 293	7,27	5 958	9,4	7 774	11,0	9 098
6	1	10	5,2	3 498	7,2	4 893	8,3	5 598	11,1	7 464	12,57	8 392	16,3	10 962	19,1	12 828
8	1,25	13	12,6	6 426	17,7	8 997	20	10 283	27	13 710	30,62	15 423	39	20 137	46	23 565
10	1,50	16	25	10 238	35	14 334	40	16 382	53	21 843	61	24 575	78	32 082	92	37 542
12	1,75	18	43	14 934	60	20 908	69	23 895	92	31 860	105	35 849	136	46 795	159	54 760
14	2	21	69	20 514	97	28 719	111	32 822	148	43 763	167	49 142	218	64 277	255	75 218
16	2	24	108	28 280	152	39 592	174	45 248	232	60 331	262	67 944	341	88 611	399	103 694
18	2,5	27	149	34 324	209	48 054	239	54 919	330	75 421			469	107 549	549	125 856
20	2,5	30	213	44 188	298	61 863	341	70 700	471	97 253			667	138 456	781	162 023
22	2,5	34	293	55 298	411	77 418	470	88 478	648	121 574			920	173 269	1 077	202 762
24	3	36	366	63 630	513	89 083	586	101 809	809	140 084			1 148	199 376	1 343	
27	3	41	544	83 910	762	117 474	871	134 257	1 201	184 517			1 706	262 920	1 997	307 672
30	3,5	46	737	101 914	1 032	142 679	1 180	163 062	1 628	224 292			2 311	319 331	2 704	373 685
33	3,5	50	1 004	127 210	1 406	178 094	1 607	203 536	2 216	279 953			3 148	398 593	3 684	466 438
36	4	55	1 288	149 174	1 803	208 844	2 060	238 679	2 840	328 236			4 036	467 413	4 723	546 973
39	4	60	1 677	179 487	2 348	251 282	2 683	287 179	3 697	394 919			5 255	562 393	6 150	658 119
42**	4,5	65	2 070	205 323	2 898	287 452	3 312	328 516	4 554	451 710			6 486	643 344	7 590	752 849
45**	4,5	70	2 596	240 641	3 635	336 897	4 154	385 025	5 712	529 410			8 136	754 008	9 520	882 350
48**	5	75	3 130	270 321	4 383	378 449	5 009	432 514	6 887	594 706			9 809	847 006	11 478	991 177
52**	5	80	4 041	324 763	5 657	454 668	6 465	519 620	8 889	714 478			12 661	1 017 590	14 816	1 190 797
56**	5,5	85	5 034	374 739	7 048	524 635	8 054	599 582	11 075	824 426			15 773	1 174 182	18 458	1 374 043
60**	5,5	90	6 266	438 337	8 772	613 672	10 026	701 340	13 785	964 342			19 634	1 373 457	22 976	1 607 237
64**	6	95	7 533	495 676	10 546	693 947	12 052	793 082	16 572	1 090 488			23 603	1 553 119	27 620	1 817 480

* Grade 8-8a up to d=16 mm, 8-8b above d=118 mm

STANLEY®

PLIERS



PLIERS
LOCKING PLIERS
VDE PLIERS

PERFECTION IN ACTION

Extensive quality testing is done on every clamping tool design, ensuring that daily performance exceeds industry standards. This comprehensive range allows for varied utility.

THE COMPREHENSIVE RANGE OF PLIERS

Whatever the task is, there is a STANLEY® pliers to help. Manufactured from quality steel, the range of pliers are built for high performance in any situation.

The range of options include linesman, combination, diagonal cutter, long nose, bent nose, wire stripper, slip joint, groove joint, and locking pliers.

PLIERS Available as:
Linesman, combination, long nose, bent nose, wire stripper, slip joint & groove joint variants



LOCKING PLIERS Available as:
Curved jaw, Straight jaw, Long nose, Welding, Sheet metal or 'C' clamp variants



LINESMAN



LONG NOSE



SLIP JOINT



DIAGONAL CUTTER



WIRE STRIPPERS



CURVED JAW



ANSI
American National Standards Institute

VDE PLIERS

STANLEY® is proud to be one of the market leaders in providing VDE solutions. Tested and proven, these tools either meet or exceed industry standards and can ensure safety when working with live equipment up to 1000VAC or 1500VDC

PIPE PLIERS

The pipe pliers by STANLEY® boast a solid cast iron body and jaw forged with chrome molybdenum steel. Tough materials are used to ensure that the entire range provides users with great performance and durability.

ADJUSTABLE WRENCH

Every wrench produced by STANLEY® exceeds ANSI standards. Adjustable jaw design allows tool to grip many fastener sizes. Knurl adjusting mechanism is available for quick and precise adjustments

COMBINATION PLIERS



- Material: C45, Full Body Hardened
- Jaws & Cutting Edge are Induction Hardened & Tempered- Black - Phosphate Finish
- Anti-Rust Protected
- Single Acetate / Double Color Sleeve (Acetate + TPR)

PART No.	DESCRIPTION	SIZE	PBQ
70-461	Combination Plier, Single Color Sleeve	205mm/ 8	6
70-482	Combination Plier, Double Color Sleeve	205mm/ 8	6



LONG NOSE PLIERS

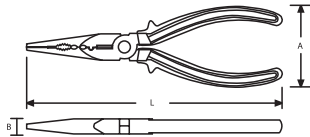

- Forged carbon steel jaws fully heat treated for long performance life and durability
- Induction harden cutting edges for greater reliability in cutting
- Bi-material soft grip handle providing excellent comfort
- Ergonomically designed Dyangrip handle with finger guards for better efficiency and handle

PART No.	DESCRIPTION	SIZE	PBQ
70-462	Long Nose Plier Single Color Sleeve	152mm/ 6	6
70-483	Long Pose Plier Double Color Sleeve	152mm/ 6	6



CIRCLIP PLIERS - STRAIGHT (INTERNAL)



- Overall Cr-v Forging Steel derived, Durable
- In strict accordance with the DIN5254 standards of production
- The first clamp Fine polishing and processing blackening, good looking
- Single Acetate / Double Color Sleeve (Acetate + TPR)

PART No.	DESCRIPTION	SIZE	PBQ
84-362-23	Plier Circlip, Straight Internal	130mm-5	6
84-363-23	Plier Circlip, Straight Internal	180mm-7	6
84-364-23	Plier Circlip, Straight Internal	230mm-9	6



CIRCLIP PLIERS - STRAIGHT (EXTERNAL)

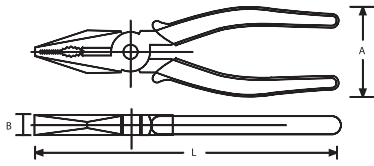

- Overall Cr-v Forging Steel derived, Durable
- In strict accordance with the DIN5254 standards of production
- The first clamp Fine polishing and processing blackening, good looking
- Single Acetate / Double Color Sleeve (Acetate + TPR)

PART No.	DESCRIPTION	SIZE	CAPACITY MM	PBQ
84-332-23	Plier Circlip, Straight External	130mm-5	8-25	6
84-334-23	Plier Circlip, Straight External	180mm-7	19-60	6
84-335-23	Plier Circlip, Straight External	230mm-9	35-100	6



CIRCLIP PLIERS - BENT (EXTERNAL)

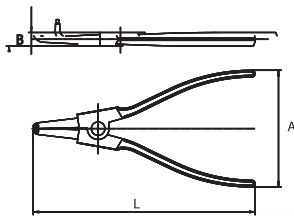

- Overall Cr-v Forging Steel derived, Durable
- In strict accordance with the DIN5254 standards of production
- The first clamp Fine polishing and processing blackening, good looking
- Single Acetate / Double Color Sleeve (Acetate + TPR)

PART No.	DESCRIPTION	SIZE	CAPACITY MM	PBQ
84-338-23	Plier Circlip, Bent External	130mm-5	8-25	6
84-341-23	Plier Circlip, Bent External	180mm-7	19-60	6
84-348-23	Plier Circlip, Bent External	230mm-9	35-100	6



CIRCLIP PLIERS - BENT (INTERNAL)

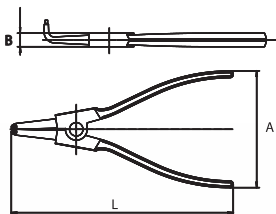

- Overall Cr-v Forging Steel derived, Durable
- In strict accordance with the DIN5254 standards of production
- The first clamp Fine polishing and processing blackening, good looking
- Single Acetate / Double Color Sleeve (Acetate + TPR)

PART No.	DESCRIPTION	SIZE	CAPACITY MM	PBQ
84-446-23	Plier Circlip, Bent Internal	130mm/ 5	8-25	6
84-447-23	Plier Circlip, Bent Internal	180mm/ 7	19-60	6
84-448-23	Plier Circlip, Bent Internal	230mm/ 9	35-100	6



LINESMAN PLIERS



- Forged Steel construction
- Double dipped handles for comfortable use
- Hand ground cutting edges
- Machined jaws for gripping
- Rust-resistant finish
- Chrome-Nickel steel for tough durable hardened cutting edge

PART No.	DESCRIPTION	A(MM)	B(MM)	L(MM)	PBQ
STHT84112-8	7" Linesman Pliers	50	12.5	188	6
STHT84113-8	8" Linesman Pliers	50	12.8	218	6



DIAGONAL CUTTING PLIERS



- Forged carbon steel jaws fully heat treated for optimum performance and durability
- Double dipped handle allows for a comfortable grip
- Drop-forged steel is strong and durable
- Meets ANSI specifications

PART No.	DESCRIPTION	A(MM)	B(MM)	L(MM)	PBQ
STHT84105-8	6" Diagonal Cutting Pliers	50	10.5	154.5	6
STHT84108-8	7" Diagonal Cutting Pliers	50	11.5	180	6



LONG NOSE PLIERS

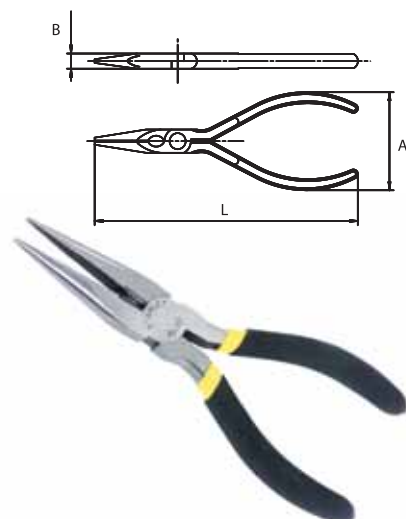

- Forged carbon steel jaws fully heat treated for long performance life and durability
- Induction harden cutting edges for greater reliability in cutting
- Bi-material soft grip handle providing excellent comfort
- Ergonomically designed Dyangrip handle with finger guards for better efficiency and handle

PART No.	DESCRIPTION	A(MM)	B(MM)	L(MM)	PBQ
84-101-23	6" Long Nose Pliers	48.6	9.5	170	6
STHT84102-8	8" Long Nose Pliers	50	11.2	200	6



MINIATURE PLIERS

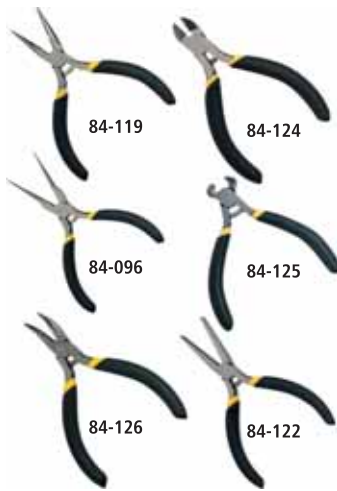

- Small sized for precision work
- Nickel chromed for durability
- Double dip handles for comfort

PART No.	DESCRIPTION	A(MM)	B(MM)	L(MM)	PBQ
84-096-23	5" Needle Nose Plier Mini	48.5	7.5	148	6
STHT84119-8	5" Long Nose Plier Mini	48.5	7.5	130	6
STHT84122-8	4" Flat Nose Pliers Mini	48.5	7.5	134	6
STHT84124-8	4" Diagonal Cutting Plier Mini	48.5	7.5	109.5	6
STHT84125-8	4" End Nipper Plier Mini	48.5	7.5	103.5	6
STHT84126-8	5" Bent Nose Plier Mini	48.5	7.5	125.5	6



PLASTIC NIPPERS



PART No.	DESCRIPTION	SIZE	PBQ
84-134-1-23	Plastic Nipper	127mm/ 5	6
84-135-1-23	Plastic Nipper	152mm/ 6	6



COMBINATION SNAP RING PLIER



- Internal-external positioning 45°-90°-180°
- 10-50mm range

PART No.	DESCRIPTION	SIZE	PBQ
84-168	Plier Comb Snap Ring, Int-ext Post,	152mm / 6	1

CRIMPING PLIERS



- Cuts electrical wires strips insulation shears screws & bolts clean
- (Warning: Grips do not protect against electrical shock.)

PART No.	DESCRIPTION	SIZE	PBQ
84-223-22	Crimping Plier	230mm - 9	6
84-253-22	Crimping Plier Set	230mm - 9	6

WIRE STRIPPER WITH CUTTING EDGE



- Professional peeling ideal tool for cutting the line
- Used for line suppressing & line bending function
- Laser calibration & facilitate operations

PART No.	DESCRIPTION	SIZE	PBQ
84-475-22	Wire Stripper(cutter)-awg12-22	150mm/6	10



WISE-GRIP®

LOCKING PLIERS

The Original
Since 1924*

IRWIN® VISE-GRIP® Original locking tools, with a classic guarded trigger release, are designed to provide maximum locking force.



Fast Release

IRWIN® VISE-GRIP® Fast Release locking pliers have a one-handed, triggerless release, so they're twice as easy to open as the traditional design. Plus, anti-pinch, non-slip ProTouch™ Grips provide comfort, control, and less hand fatigue.



SELF-ENERGISING LOWER JAW

UNIQUE CURVED JAW

PROTOUCH™ GRIPS

10CR FAST RELEASE LOCKING PLIER - THE PERFECT GRIP FOR ANY JOB.

BUILT STRONG TO LAST LONG

T11T

HEX KEY ADJUSTING SCREW



1. UNIQUE CURVED JAW

Great for securely gripping and torquing multiple surface shapes, including round pipes, square or hex bolts and more. Perfect for any application that requires maximum torque

2. SELF-ENERGISING LOWER JAW

Jaw mechanism provides 3X more gripping power*. Pivot allows jaw to align on workpiece for maximum grip without slipping or stripping

3. PROTOUCH™ GRIPS

Provides comfort, control and less hand fatigue

4. 2X LONGER LIFE*

High grade alloy steel is heat treated for maximum toughness and durability

5. HEX KEY ADJUSTING SCREW

Tightens to draw material closer together for tighter grip. Loosens to provide controlled release

3X MORE GRIPPING POWER*

2X LONGER LIFE*

ProTouch™
GRIPS

FAST RELEASE™ CURVED JAW LOCKING PLIERS



- Cuts electrical wires strips insulation shears screws & bolts clean
- (Warning: Grips do not protect against electrical shock.)

PART No.	DESCRIPTION	SIZE	PBQ
4935581	5cr Fast Release	5"/125mm	5
T13T	7cr Fast Release	7"/175mm	5
T11T	10cr Fast Release	10"/250mm	5

FAST RELEASE STRAIGHT JAW LOCKING PLIERS



- Straight jaws provide maximum contact on flat, square or hex work pieces

PART No.	DESCRIPTION	SIZE	PBQ
T03T	IR VG Fast Release 7 R	7"/175mm	5
T01T	IR VG Fast Release 10 R	10"/250mm	5

FAST RELEASE STRAIGHT JAW LOCKING PLIERS



- Long Straight nose provides easy access in narrow, hard-to-reach places

PART No.	DESCRIPTION	SIZE	PBQ
T14T	6LN FAST RELEASE	6"/150mm	5
T15T	9LN FAST RELEASE	9"/225mm	5

FAST RELEASE C-CLAMP LOCKING



- Wide opening jaws provide greater versatility for clamping a variety of shapes

PART No.	DESCRIPTION	SIZE	PBQ
17T	C-clamp Locking 6R Fast Release	6"/150mm	5
19T	C-clamp Locking 11R Fast Release	11"/275mm	5

CURVED JAW LOCKING PLIERS



PART No.	DESCRIPTION	SIZE	PBQ
10508018	IR VG CJ LP 7CR	7"/175mm	5
10508017	IR VG CJ LP 10CR	10"/250mm	5

STRAIGHT JAW LOCKING PLIERS

- Straight jaws provide maximum contact on flat, square or hex work
- Can also be used as a portable vice



PART No.	DESCRIPTION	SIZE	PBQ
T0302EL4	IR VG LP Straight JAW 7R	7"/175MM	5
T0102EL4	IR VG LP Straight JAW 10R	10"/250MM	5

LONG NOSE LOCKING PLIERS

- Long Straight nose provides easy access in narrow, hard-to-reach places
- Ideal for precision work and hobbies



PART No.	DESCRIPTION	SIZE	PBQ
T1602EL4	IR VG 4LN Long Nose	4"/100m	5
T1402EL4	IR VG 6LN Long Nose	6"/150mm	5
T1502EL4	IR VG 9LN Long Nose	9"/225mm	5

LOCKING C-CLAMPS WITH REGULAR TIPS

- Wide opening jaws provide greater versatility - can clamp wide variety of shapes



PART No.	DESCRIPTION	SIZE	PBQ
T17EL4	IR VG Regular Tips 6R	6"/150mm	5
T19EL4	IR VG Regular Tips 11R	11"/275mm	5
T18R	IR VG Regular Tips 18R	18"/455mm	5
T24R	IR VG Regular Tips 24R	24"/600mm	5

LOCKING PLIERS WITH BI-MATERIAL HANDLE

STANLEY

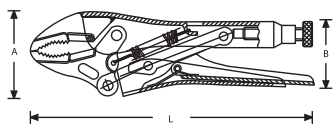

- Bi-material handle for anti-slip & comfort
- Serrated jaws made of Cr-Mo material
- Heat treated adjustable screw
- Curved jaws puts tremendous pressure on four points at any style or bolt head

PART No.	DESCRIPTION	A(MM)	B(MM)	L(MM)	PBQ
84-369-1-23	10" Curved Jaw Locking Pliers	65	60	254	10



VDE PLIERS SET

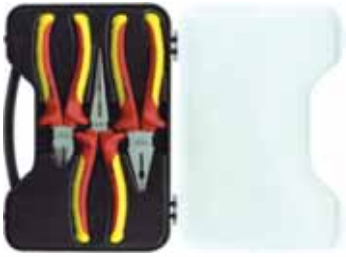

- 1000 volt rated handle, safe live wire working handle tested up to 10000 volts, conform to current norms
- Bi-material grip for comfort
- Finger guard for better control & added user safety
- Confirm to DIN standard

PART No.	DESCRIPTION	PBQ
84-011	VDE 3Pc Pliers Set (84-001,84-003,84-007)	1



VDE COMBINATION PLIERS



- 1000 volt rated handle, safe live wire working handle tested up to 10000 volts confirm to current norms
- Bi-material grip for comfort
- Finger guard for better control & added user safety
- Confirm to DIN standard
- EN 60900, ICE/CEI 900 VDE 0680

	DESCRIPTION	SIZE	PBQ
0-84-001	Vde Combination Plier	175mm/6.5	4
0-84-002	Vde Combination Plier	200mm/8	4

VDE DIAGONAL CUTTING PLIER



- 1000 volt rated handle, safe live wire working handle tested up to 10000 volts confirm to current norms
- Bi-material grip for comfort
- Finger guard for better control & added user safety
- Confirm to DIN standard
- EN 60900, ICE/CEI 900 VDE 0680

PART No.	DESCRIPTION	SIZE	PBQ
0-84-003	VDE Diagonal Cutting Plier	180mm/ 7	4

VDE LONG NOSE PLIERS

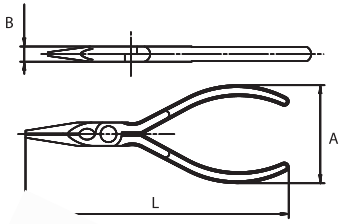

- Safe live line working to 1,000V
- DIN / ASO / ANSI compliant

PART No.	DESCRIPTION	L(MM)	PBQ
84-006	6" Long Nose Pliers	165	4



VDE BENT NOSE PLIERS

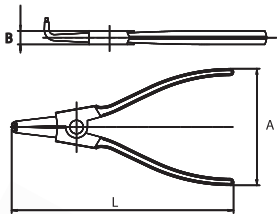

- Safe live line working to 1,000V
- DIN / ASO / ANSI compliant

PART No.	DESCRIPTION	L(MM)	PBQ
84-008	8" Bent Nose Pliers	200	4



VDE WIRE STRIPPER PLIERS

- Safe live line working to 1,000V
- DIN / ASO / ANSI compliant

PART No.	DESCRIPTION	L(MM)	PBQ
84-010	6.5" Wire Stripper Pliers	170	4



VDE END CUTTERS

- Safe live line working to 1,000V
- DIN / ASO / ANSI compliant



PART No.	DESCRIPTION	L(MM)	PBQ
84-016	6.5" End Cutters	165	4



VDE WATER PUMP PLIERS

- Safe live line working to 1,000V
- DIN / ASO / ANSI compliant

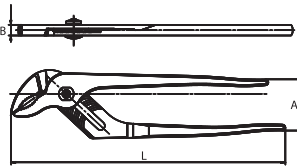

PART No.	DESCRIPTION	L(MM)	PBQ
84-294	10" Waterpump Pliers	255	4



STANLEY®

PIPE TOOLS



ALUMINUM PIPE WRENCH
CI PIPE WRENCH, STILSON PIPE WRENCH
WATER PUMP PLIER, TUBING CUTTER

WORK WITH HIGHER EFFICIENCY



PIPE PLIERS

The pipe pliers by STANLEY® boast a solid cast iron body and jaw forged with chrome molybdenum steel. Tough materials are used to ensure that the entire range provides users with great performance and durability..



PIPE CUTTERS

STANLEY® offers an array of pipe cutters that are perfect additions to the tool box. Used for cutting metal and plastic pipes, there is an expectation for these cutters to be strong, durable and precise.

PIPE WRENCHES

IRWIN® Record® offer a full range of plumbing tools designed to get the job done quickly and efficiently. From our solid-forged Stillson Wrenches to the lightweight Quick-Adjusting Wrench, our range of pipe tools offer superior grip due to the unique 'V-shaped' tooth profile.

FORGED HOOK JAW

QUICK-ADJUSTING JAW

CAST ALUMINIUM CONSTRUCTION

IRWIN RECORD QUICK-ADJUSTING PIPE WRENCH



1. FORGED HOOK JAW

With 2-1/4" (58mm) jaw capacity equivalent to standard 14" (350mm) pipe wrench; ideal for pipe diameters up to 1-1/2" (38mm); ideal for most surfaces including black, galvanized, PVC and copper pipe, as well as nuts, bolts and couplings; broached teeth

2. QUICK-ADJUSTING JAW

With one-handed operation, ratchets quickly to work the surface

3. CAST ALUMINIUM CONSTRUCTION

40% less weight than standard 14" (350mm) cast iron pipe wrench; ergonomic handle is ideal for heavy torque and maximum comfort

3X FASTER*

QUICK - ADJUSTING PIPE WRENCH

PART No.	SIZE	OPENING CAPACITY (mm)	PIPE CAPACITY (mm)	PBQ
105036421	2"/300mm	3-58	38	5

LEADER PIPE WRENCHES

- One-piece ductile iron casting assures heavy-duty use
- Drop-forged jaws with to resist wear, distortion or breakage
- Hardened and tempered teeth provide excellent bite



PART No.	DESCRIPTION	SIZE	PBQ
T3508	Leader Wrench	8"/200mm 1" (25mm)	4
T35010	Leader Wrench	10"/250mm 1-1/2" (38mm)	4
T35012	Leader Wrench	12"/300mm 2" (51mm)	4
T35014	Leader Wrench	14"/350mm 2" (51mm)	4
T35018	Leader Wrench	18"/450mm 2-1/2" (63mm)	4
T35024	Leader Wrench	24"/600mm 3" (76mm)	1
T35036	Leader Wrench	36"/900mm 5" (127mm)	1
T35048	Leader Wrench	48"/1220mm 6" (152mm)	1

HEAVY DUTY PIPE WRENCH (CAST IRON)



PART No.	DESCRIPTION	SIZE	WT. (KG)	O/A LEN	MAX. JAW OPENING	PBQ
87-622-23	Pipe Wrench	250mm/10	0.81	248mm	45mm	6
87-623-23	Pipe Wrench	300mm/12	1.41	297mm	55mm	6
87-624-23	Pipe Wrench	350mm/14	1.4	332mm	65mm	6
87-625-23	Pipe Wrench	450mm/18	2.38	414mm	80mm	2
87-626-23	Pipe Wrench	600mm/24	3.83	553mm	95mm	1
87-627-23	Pipe Wrench	900mm/36	7.88	805mm	140mm	1

STILSON TYPE PIPE WRENCH



PART No.	DESCRIPTION	SIZE	MAX. JAW OPENING	PBQ
71-641	Pipe Wrench Stillson Type	250mm/10	45mm	6
71-642	Pipe Wrench Stillson Type	300mm/12	55mm	6
71-643	Pipe Wrench Stillson Type	350mm/14	65mm	4
71-644	Pipe Wrench Stillson Type	450mm/18	80mm	4
71-645	Pipe Wrench Stillson Type	600mm/24	95mm	2



PVC PIPE CUTTER



- Heavy Duty PVC Pipe cutter
- Stainless steel blades
- Heat treated for durability

PART No.	DESCRIPTION	CUTTING CAPACITY	PBQ
14-442	Pvc Pipe Cutter,	Up To 42mm	10

TUBING CUTTER



- Tubing cutters for cutting copper/plastic tubing

PART No.	DESCRIPTION	CUTTING CAPACITY	PBQ
93-021-22	Tubing Cutter H/d,	3mm-1/8" To 28mm-1 1/4"	10



GROOVELOCK WATER PUMP PLIERS WITH PROTOUCH™ GRIP



WATER PUMP PLIERS

GrooveLock Pliers are designed with twice the number of groove positions as traditional groove joint pliers to deliver optimal hand and jaw positioning - providing a superior grip. The specially engineered, all-purpose jaw grips round, hex, square and flat surfaces for incredible versatility.



1. **ALL-PURPOSE JAW**
Grips onto flat, round, hex & square work pieces to provide tremendous bite
2. **PRESS-N-SLIDE BUTTON**
Adjusts jaws 2X faster than traditional groove joint pliers
3. **MULTI-GROOVE RATCHETING SYSTEM**
Has twice the groove positions than other groove joint pliers, for precise positioning on any type of work surface
4. **ANTI-PINCH NON-SLIP PROTOUCH GRIPS**
Provide comfort, control and less hand fatigue

2X FASTER*
*vs traditional Groove Joint pliers

Protoch™
GRIPS

GrooveLock
Pliers

GROOVE LOCK WATER PUMP PLIER



PART No.	DESCRIPTION	SIZE	JAW CAPACITY	PBQ
T9097850	Groove Lock	10"/250mm V-Jaw Pliers	80mm	5

PLIERS - GROOVE JOINT PLIERS

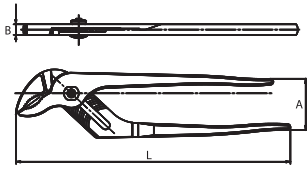

- Forged carbon steel jaws fully heat treated for long performance life and durability
- Induction harden cutting edges for greater reliability in cutting
- Bi-material soft grip handle providing excellent comfort
- Ergonomically designed Dyangrip handle with finger guards for better efficiency and handle

PART No.	DESCRIPTION	A(MM)	B(MM)	L(MM)	PBQ
84-110-23	10" Groove Joint Pliers	48.2	10	258	6
84-111	12" Groove Joint Pliers			305	4



WATER PUMP PLIER

- Safe live line working to 1,000V
- DIN / ASO / ANSI compliant



PART No.	DESCRIPTION	SIZE	PBQ
71-668	Water Pump Plier Box Joint, Curve Steel	175mm-7	10
71-669	Water Pump Plier Box Joint, Curve Steel	250mm-10	10
71-670	Water Pump Plier Box Joint, Curve Steel	300mm-12	4

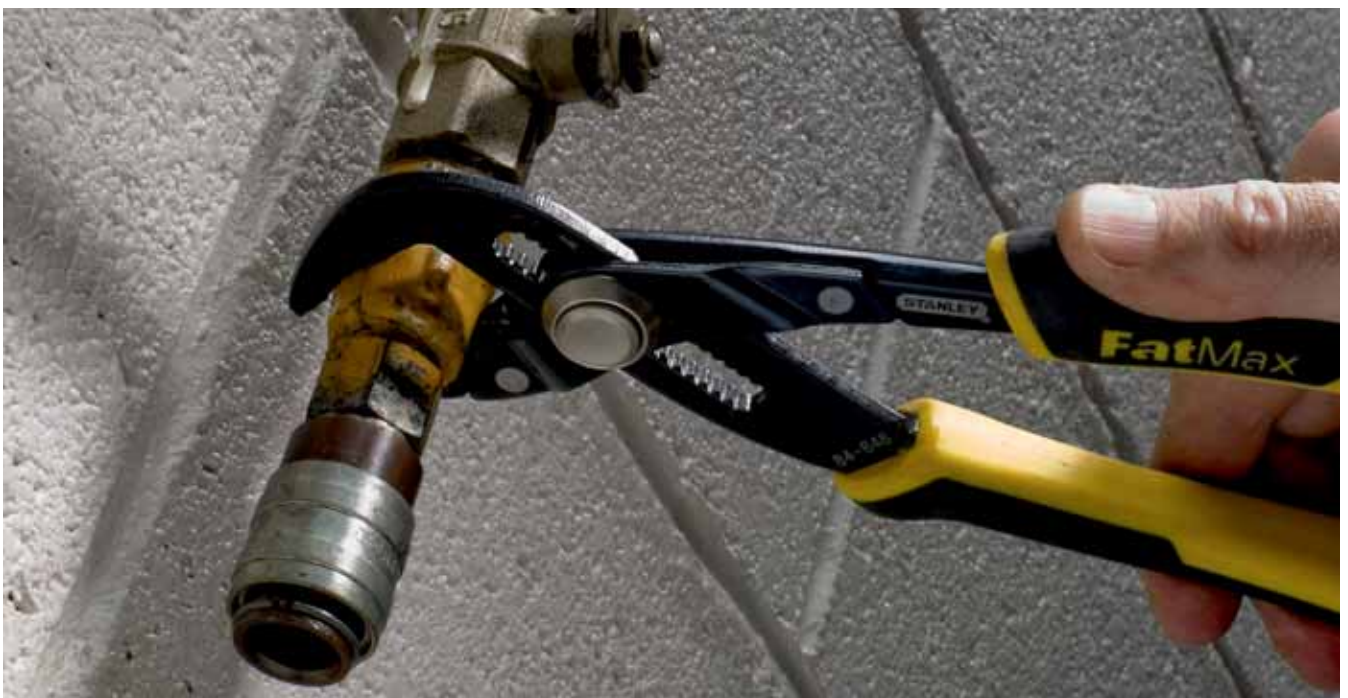

STANLEY®

CUTTING TOOLS



**RETRACTABLE UTILITY KNIFE & BLADES
SNAP-OFF KNIFE & BLADES
HACKSAWS, BOLT CUTTERS & SNIPS**

PRECISION EVERY TIME

STANLEY® manufactured its first utility knife back in 1935. We are the pioneer and innovator in this category. The STANLEY® cutting tool range is built to last, to provide excellent cutting performance and to have noteworthy safety and ergonomic features.



SNAP-OFF KNIVES

STANLEY® Snap-off Knives have high quality carbon steel blades that snap off in sections, providing a fresh and sharp cutting point to the user without the need to open up the knife. We bring innovation to snap-off knives by providing unique features that users have never experienced before.



UTILITY KNIVES

The STANLEY® range of advanced utility knives encompass a design that features more comfort, grip and handling than other brands.

They have a thicker knife blade, simplifying efforts when it comes to tough cutting tasks. We provide a wide range of utility knives that offer different blade options and special applications.

Do you know...

Stanley's blades are very popular in the market. In fact, its state-of-the-art manufacturing facilities must pump out 20,000 miles of blades each and every year to keep up with the demand.



Leather



Cardboard



Carpet



Venyl



SNIPS

The STANLEY® range of advanced utility knives encompass a design that features more comfort, grip and handling than other brands. They have a thicker knife blade, simplifying efforts when it comes to tough cutting tasks. We provide a wide range of utility knives that offer different blade options and special applications.



HACKSAWS

STANLEY® hacksaws have excellent safety features, making them some of the safest and most reliable tools on the market. Its excellent blade tension mechanism system plays a role in ensuring that less accidents happen on the job, creating a safe and tension-free work environment.



KNIFE BLADES

Extensive tests and the use of advanced technology such as induction heat treated blade edge, make STANLEY® the leader in the category.

FUN FACT

In the UK, Australia and New Zealand, any Utility Knife is simply known as a STANLEY® knife

InterLock® SELF RETRACTING UTILITY KNIFE



- Spring loaded blade reacts into knife automatically when pressure on slide button is released
- Interlocking nose secures blade safely between knife halves
- Orange coloured for high visibility & safety

PART No.	DESCRIPTION	L(MM)	W(MM)	BLADE THICKNESS (MM)	NO. OF BLADE	PBQ
10-189C	Self Retracting Utility Knife	150.3	20.2	0.65	1	6

SAFETY

Springback Safety



Classic99® RETRACTABLE UTILITY KNIFE



- The one & only Original STANLEY®
- Interlock™ nose firmly secures the blade into the knife
- Three position retractable blade
- Blade storage in handle

PART No.	DESCRIPTION	L(MM)	W(MM)	BLADE THICKNESS (MM)	NO. OF BLADE	PBQ
STHT10099-8	Classic 99 Retractable, Grey	157	18.5	0.65	1	6

RETRACTABLE



RETRACTABLE UTILITY KNIFE



- Plastic & Die cast zinc body shaped for comfort in use
- Multi position blade slide
- 3 Pcs. Blade Storage Handle

PART No.	DESCRIPTION	L(MM)	W(MM)	BLADE THICKNESS (MM)	NO. OF BLADE	PBQ
10-175	Retractable Utility Knife	154	18.7	0.65	1	6

RETRACTABLE



BI-METAL UTILITY BLADES



BI-METAL BLUE BLADES

Bi-Metal is formed by welding high-speed steel edge and spring steel, having the benefit of both types: Safety & Longer Life.

IRWIN® Bi-metal Blue Blades are safer since they will not break under normal working conditions, and they help reduce the risk of injury from breaking or shattering blades. And, with the blades lasting longer than traditional carbon blades, they result in fewer blade changes which means fewer accidental cuts.

SNAP-OFF BLADES
SOFT SNAP
TECHNOLOGY

- 1. SHATTERPROOF**
Spring steel allows the blade to bend without accidentally breaking
- 2. LAST 3 TIMES LONGER***
High speed steel hardened cutting edge stays sharp 3X longer than traditional carbon blades which means more cuts for the money
- 3. TRAPEZOID BLADES FIT MOST KNIVES**
Two-notch blade design fits most utility knives
- 4. SNAP-OFF BLADES SOFT SNAP TECHNOLOGY**
For breaking a new edge confidently

3X LONGER LIFE*
*vs. traditional carbon blades



*vs IRWIN® carbon blades 10504245 / 10504561

BI-METAL UTILITY BLADES



- Shatterproof spring steel body allows blade to bend and flex
- Snub nose reduces risk of accidental puncture wound

PART No.	DESCRIPTION	JAW CAPACITY	PBQ
10504240	Bi-Metal Utility Blades	5 Pc	5

CARBON UTILITY BLADES



- Carbon blade for general purpose
- Cutting carbon steel cutting edge

PART No.	DESCRIPTION	BLADE QUANTITY	PBQ
10504246	Carbon Utility Blades	10 Pc with Dispenser	5

CUTTING TOOLS

CARBON UTILITY BLADES



- Carbon blade for general purpose
- Cutting carbon steel cutting edge

PART No.	DESCRIPTION	BLADE QUANTITY	PBQ
10504247	Carbon Utility Blades	100pc with Dispenser	1

BI-METAL SAFETY UTILITY BLADE



- Shatterproof spring steel body allows blade to bend and flex
- Snub nose reduces risk of accidental puncture wound

PART No.	DESCRIPTION	BLADE QUANTITY	PBQ
10505823	Carbon Utility Blades	5pc	5



HEAVY DUTY UTILITY BLADE

- Heavy duty blade, ideal for carpet & vinyl
- Replacement Blade for 10-099, 10-175, 10-189

PART No.	DESCRIPTION	SIZE	PACK DETAILS	# BLADES	PBQ
11-921H	Heavy Duty Blade	19mm / 3/4	100 Dispensers Of 10pcs	100 Pcs.	1



Dispenser option

Quick-Point™ BLADE

- Replacement blade for 10-425

PART No.	DESCRIPTION	SIZE	PBQ
0-11-325	Quick Point Blade	26mm	10



LARGE HOOK BLADE

- Sharpened hook with point for penetrating & cutting sheet material
- Replacement blade for 10-099, 10-175, 10-189

PART No.	DESCRIPTION	SIZE	# BLADES	PBQ
11-983A	Large Hook Blade	19mm	100	4



DynaGrip® SNAP-OFF KNIFE



- Dynagrip™ series adding the new softgrip on top of the durable case bi-material with soft TPR providing comfort with performance
- Dial lock with security & firm blade control for heavy duty cutting
- Rigid stainless steel barrel provides smooth action & corrosion resistance
- Removable blade snapper included in cap of knife

PART No.	DESCRIPTION	W(MM)	L(MM)	LOCKING MECHANISM	# BLADES	PBQ
STHT10418-812	Dynagrip™ Snap-off Knife 18mm	18	165	Screw Dial Lock	1	6
STHT10425-812	Dynagrip™ Snap-off Knife 25mm	25	178	Screw Dial Lock	1	6



DIAL LOCK
with security and firm blade control for heavy-duty cutting

18MM SNAP-OFF KNIFE

- Light-duty, auto lock knife with Quick Point™ blades
- Durable and compact ABS body for simple storage and handling



PART No.	DESCRIPTION	W(MM)	L(MM)	LOCKING MECHANISM	# BLADES	PBQ
STHT10276-812	18mm Snap-off Knife	18	172	Screw Dial Lock	3	20



USER TIPS

- Ensure that the blades are properly seated and fastened before use.
- Always use a sharp blade as blunt ones have a higher risk of slipping due to the extra force needed to work it.
- Keep hands away from the cutting line.
- Do not bend, assert pressure or apply side loads to the blades.
- Always pull the knife towards yourself when cutting on a flat surface.
- Never leave a knife unattended with its blade exposed

QUICK POINT KNIFE

- Impact resistant ABS plastic body
- Secure multi position slide button



PART No.	DESCRIPTION	SIZE	BLADES SIZE	PBQ
STHT10150 812	Knife Quick Point	130mm / 5 1/8	9mm	6
STHT10151 812	Knife Quick Point	160mm / 6 1/2	18mm	6



Quick-Point® BLADE

- Replacement blade for 10-418, 0-10-151 and other 18mm snap-off knives
- Blade with 8 cutting points.



PART No.	DESCRIPTION	SIZE	PBQ
11-301H	Knife Blade 18mm	110mm	10

SAFETY WRAP CUTTER

- Replaceable shrink wrap cutter. Replaceable piece also an individual unit
- Fatigue reducing handle design reduces required grip pressure by supporting hand in U-shape handle base, for easier pull cutting
- Full length knuckle guard protects hand when in use tape splitter
- Lanyard hang hole for easy tethering, transportation & storage





PART No.	DESCRIPTION	PBQ
STHT10244	Safety Wrap Cutter* Carded 6	6
STHT10245	Replacement Safety Wrap Cutter Blades Carded 6	6

STANLEY® Wrap Cutter
Replacement blade
•Compatible with STHT10244

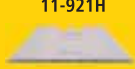
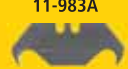

KNIFE & BLADE SELECTION GUIDE

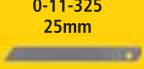
STANLEY	11-921H	11-983A	11-301H 18mm	0-11-325 25mm
Classic 99 STHT10099-8				
Home Owner's 10-175	●	●		
Interlock 10-189C	●	●		
DynaGrip STHT10418-8			●	
DynaGrip STHT10425-8				●
Quick-Point STHT10151-812 STHT10276-812			●	

JUNIOR HACKSAW

- Quick release hacksaw features a lever moulded into grip handle for easy blade change
- Deep throat for good work capacity
- 1 Blade free



PART No.	DESCRIPTION	BLADE SIZE	PBQ
0-15-218	Junior Hacksaw	150mm / 6	10

CUTTING TOOLS - STEEL FRAME HACKSAW

- Positive locking mechanism
- Two blade position 90° / 55°
- Aluminium handle - 12" blades



PART No.	DESCRIPTION	SIZE	PBQ
15-166	Hacksaw- Steelframe	305mm / 12	6

RUBBER GRIP HACKSAW



- Adjustable to 8", 10" & 12" blades
- Comfort pistol grip handle with patented pattern for better grip & control
- Allows positioning of the blade at 90° for more versatility
- 101.6mm (4") throat depth

PART No.	DESCRIPTION	DEPTH OF THROAT	BLADES SIZE	PBQ
15-265-23	Rubber Grip Hacksaw - Adjustable Frame	98mm / 3 7/8	254mm / 10	6

MINI HACK™ SAW



- Handle covers blade to help protect hand
- Designed to cut metal & plastic in hard to reach places
- Structurally designed for maximum strength & durability

PART No.	DESCRIPTION	BLADES SIZE	DEPTH OF THROAT	PBQ
0-20-807	Mini Hack Saw	254mm / 10"	220mm / 8" 3/4"	6

GLASS CUTTER



- Die cast handle has a wide contoured comfort grip and ball end for tapping
- Steel wheel with general purpose cutting angle delivers precise scoring clean breakout, and smooth edges
- 3 Break-off notches for various depths
- Honed Cutting wheel
- Cuts glass up to 3mm

PART No.	DESCRIPTION	SIZE	PBQ
14-125	Glass Cutter, Overall Length	130mm 5 1/8	24

WIRE STRIPPER



- Convenient hole for looping or bending wire
- Ideal for cutting, stripping speaker wire & appliance cords
- Slide adjust for various gauge wire

PART No.	DESCRIPTION	SIZE	PBQ
84-214-22	Wire Stripper	130mm 5 1/4	15

BOLT CUTTERS



- A range of bolt cutters in most sizes
- Cutter blades are of chrome molybdenum tempered steel with cutting jaws tempered HRC 60° 4 (FBS std)
- Special heat treatment give blades extra hardness & durability

PART No.	DESCRIPTION	SIZE	MAX. LOAD	MAX. CUTTING CAP	PBQ
14-308-23	Bolt Cutter	203mm / 8	36kg	3mm	6
14-312-23	Bolt Cutter	305mm / 12	46kg	4mm	6
14-314-23	Bolt Cutter	355mm / 14	54kg	5mm	6
14-318-23	Bolt Cutter	457mm / 18	65kg	6mm	6
14-324-23	Bolt Cutter	609mm / 24	62kg	8mm	2
14-330-23	Bolt Cutter	762mm / 30	84kg	10mm	1
14-336-23	Bolt Cutter	914.4mm / 36			

MaxSteel™ All PURPOSE SNIPS (STRAIGHT PATTERN)



- Exceeds ANSI standards for cutting performance & durability
- Tough alloy steel blade
- Comfortably vinyl grips
- Cuts up to 0.78mm of cold rolled steel & 0.46mm of stainless steel

PART No.	DESCRIPTION	SIZE	Cutting Capacity			PBQ
			Copper(Soft)	Cold Rolled Steel(Mild)	Hard Steel	
2-14-556	Maxsteel Snip	250mm / 10"	0.94mm	0.78mm	0.6mm	6



MaxSteel™ AVIATION SNIPS



- Excellent for cutting aluminium, vinyl siding, screening, cardboard, leather & copper
- Exceeds ANSI standards for cutting performance & durability
- Double overwind spring for longer life
- High leverage, compound cutting design cuts up to 18 gauge steel
- Patented hinge plate for easy product function identification

PART No.	DESCRIPTION	SIZE	PBQ
2-14-562	Maxsteel Aviatiin-snips - Lft Curve,	254mm / 10	6
2-14-563	Maxsteel Aviation Snips - Straight Cut	254mm / 10	6
2-14-564	Maxsteel Aviation Snips - Right Curve	254mm / 10	6

Part No.	Cutting Length	Copper (Soft)	Cold-rolled Steel (Mild)	Hard Steel (HRC30)	Hard Steel (HRC40)	Stainless Steel 304
2-14-562	35	1.50	1.20	1.00	0.60	0.90
2-14-563	35	1.50	1.20	1.00	0.60	0.90
2-14-564	38	1.50	1.20	1.00	0.60	0.90

CABLE CUTTER



- Designed for electric cable, copper, aluminium, etc.
- Notched jaw holds & cuts cables in a clean & sharp way
- Cuts up to 0.78mm of cold rolled steel & 0.46mm of stainless steel

PART NO.	DESCRIPTION	MAX CUTTING CAPACITY(MM)	SIZE	PBQ
84-258-23	Cable Cutter	60	250mm/10	6

TINSNIPS



- Serrated cutting edges to prevent slippage when cutting
- Forged alloy steel for long life
- Single pivot action & soft grip for comfort
- Interlocking joint assembly for smooth cutting
- Heat treated high chrome steel forging for long life and durability

PART NO.	DESCRIPTION	LENGTH (INCHES)	LENGTH (MM)	CUTTING CAPACITY (MM)	PBQ
14-163	Tinsnips W/o Spring	8	200	0.61 Cld Rld Steel 0.41 Stainless Steel	6
14-164	Tinsnips W/o Spring	10	250	0.78 Cld Rld Steel 0.41 Stainless Steel	6
14-165	Tinsnips W/o Spring	12	300	0.91 Cld Rld Steel 0.63 Stainless Steel	6
14-166	Tinsnips W/o Spring	14	350	1.20 Cld Rld Steel 0.70 Stainless Steel	6

STANLEY®

MEASURING & LAYOUT TOOLS



MEASURING TAPE & MEASURING WHEELS

TORPEDO, BOX, I-BEAM LEVELS

CHALK LINE REEL & REFILL

COMBINATION SQUARES

MEASURING TAPE - SHORT



Ergonomic Groove

Strap Hole

Intuitive Finger Pause



PART No.	DESCRIPTION	BLADE LENGTH	BLADE WIDTH	PBQ
STHT36125-812	STANLEY -Short Tape Rules	3m/10'	13mm	10
STHT36127-812	STANLEY -Short Tape Rules	5m/16'	19mm	10

MEASURING TAPE - TOUGH CASE

- Blade with Nylon Coating that offers 2X longer life and protects blade from scratches, rust and corrosion
- Market Leading Blade Standout that can go more than 180cm in a 5M tape
- High -Impact ABS for durability



PART No.	DESCRIPTION	BLADE			
		Case Material	LENGTH	WIDTH	STANDOUT
STHT36000-812	STANLEY TOUGH CASE	ABS	3m	13mm	1.4m
STHT36067-812	STANLEY TOUGH CASE	ABS	5m/16'	19mm	1.8m

GOOD STANDOUT
High Curvature blade for great standout

12" MEASURING WHEEL

- 12" aluminium wheel counts up to 10,000 feet (1000m) with convenient push-button reset
- 2-section snap-lock handle with ergonomic handle
- Built-in kickstand



PART No.	DESCRIPTION	WHEEL SIZE	PBQ
1-77-174	MW408, Measuring Wheel	318mm-12	1

FatMax Xtreme 180° ADJUSTABLE TORPEDO LEVEL - MAGNETIC



- Aluminium moulded ruler body durable
- Durable vials high precision 0.0005in/in. (0.5mm/M)
- 180° rotary vials can be used in multi-angle
- Self strap large vials increased visibility
- The special channel ditch facilitate a smooth circular surface use
- Fringe magnet can absorb metal surface work
- Life long accuracy guarantee

PART No.	DESCRIPTION	SIZE	PBQ
43-609I	Fatmax Xtreme TPD Level	225mm-9	6

MAGNETIC TORPEDO LEVELS



- Accuracy: 1884617, 1884618: 0.058°(1.0mm/m), 1794153: 0.029°(0.5mm/m)
- Die-cast aluminum body
- V-Groove edge with rare earth magnet inserts
- Plumb site® dual-sided viewing
- Integrated slope button 1.5° or 1/4" per foot drainage

PART No.	DESCRIPTION	SIZE	PBQ
1884617	9" - 225mm Torpedo Level (Aluminium Edge)	229mm	6
1884618	9" - 225mm Torpedo Level (Plastic)	229mm	6

CONTRACTOR Grade™ ALUMINIUM TORPEDO LEVEL - MAGNETIC



- Combines accuracy & light weight, ideal for all small installations
- 3 vials: Horizontal, plumb & 45°

PART No.	DESCRIPTION	SIZE	PBQ
STHT42465-812	LEVEL TORPEDO MAGNETIC	225mm-9	6



PLASTIC TORPEDO LEVEL - MAGNETIC



- High impact ABS plastic for durability
- Handy & economical
- 3 vials: Horizontal plumb & 45°

PART No.	DESCRIPTION	SIZE	PBQ
STHT42264-812	Level Jobmaster Torped Magnetic	225mm / 9	6

STANLEY[®] CLASSIC BOX-BEAM LEVEL

The STANLEY[®] CLASSIC BOX-BEAM features a wide range of levels that come in various sizes. New features offer better visibility, readability, durability and accuracy.

SOFT MATERIAL
used to make shock-absorbing end caps

EXCELLENT ACCURACY

center vial with 0.05mm/1m

2 PLUMB VIALS

for easy readability



strong yet lightweight

ALUMINUM FRAME

suitable for all-purpose durability

MILLING SURFACE

to provide better accurate measurement



USER TIPS

- The hang-hole allows for easy storage
- Measuring can be done from either direction, offering excellent accuracy

STANLEY CLASSIC BOX LEVELS



- New shape box design
- Block magnified central vial
- Large tubular side vials
- Vial Accuracy: 0,5mm/m

Benefits: Easier to read, More durable in case of shocks, More ergonomical, Easy to clean after use

PART No.	DESCRIPTION	SIZE	PBQ
STHT43118-12	Stanley Classic Box Level	300mm / 12	10
STHT43103-12	Stanley Classic Box Level	600mm / 24	10
STHT43105-12	Stanley Classic Box Level	1000mm / 36	10
STHT43106-12	Stanley Classic Box Level	1200mm / 48	10

B3 SERIES MAGNETIC BOX LEVELS



- Accuracy: 0.058°(1.0mm/m)
- High-strength aluminum construction and box profile for durability
- Magnified center block vial for easy and accurate reading
- 3 vials with plumb, level and 45° readings(16"/20"/24")
- Shock absorbing end caps protect the level from damage

PART No.	DESCRIPTION	SIZE	PBQ
1884587	Irwin Magnetic Box Level	12"/305mm	6
1884601	Irwin Magnetic Box Level	16"/406mm	6
1884602	Irwin Magnetic Box Level	20"/508mm	6
1884603	Irwin Magnetic Box Level	24"/609mm	6

I- BEAM LEVELS - TOP BEAD



- Durable lightweight aluminium construction suite to all purpose use
- Pipe groove allows use on round objects
- Top-read center vial designed for easy readability
- Yellow vial for increased visibility and readability
- Shock absorbing end caps hold up to heavy use
- Hang hole simplifies storage
- Replaceable 360° vials & cover
- Comfortable hand holes on 24" & 48" levels for easy handling

PART No.	DESCRIPTION	SIZE	PBQ
STHT42072-812	Level I-beam	300mm / 12	10
STHT42074-812	Level I-beam	600mm / 24	5
STHT42075-812	Level I-beam	900mm / 36	5
STHT42076-812	Level I-beam	1200mm / 48	5

Stanley® W/BUE CHALK LINE LEVEL



- Kit contains 30m chalk line, 113g blue chalk
- High impact ABS case for durability
- Sliding door for quick & easy refill
- Stainless steel end hook does not rust
- 1 oz Chalk Capacity
- Can be used vertically as a plumb bob

PART No.	DESCRIPTION	SIZE	PBQ
STHT47443-8	Stanley White / Blue Chalk and Line	30m / 100	2

COMBINATION SQUARES



- Easy-to-read
- East-to-read black precision-etched scales
- Rust Resistant Stainless Blade
- Easy-to-read vial
- Accuracy: 0.058*(1.0mm/m)
- Imperial & Metric Scales
- Imperial and metric scales on the reverse side
- Durable cast Zinc Body

PART No.	DESCRIPTION	SIZE	MATERIAL OF HANDLE	PBQ
1884634	Combination Square	6"/150mm	Metal	3
1884635	Combination Square	12"/300mm	Metal	3
1884636	Combination Square	16"/406mm	Metal	3
1884637	Combination Square	12"/300mm	Plastic	3





QUICK-GRIP®

INTRODUCING THE NEXT GENERATION IN CLAMPING TOOLS

The new IRWIN® QUICK-GRIP® One-Handed Bar Clamp range allows end-users to be even more productive on the job. The new heavy-duty and medium-duty clamps feature a Quick-Change™ button for fast conversion to a spreader and for ease-of-use with a new line of One-Handed Bar Clamp Accessories. These new IRWIN® QUICK-GRIP® One-Handed Bar Clamp Accessories provide added versatility and functionality to one-handed bar clamps—allowing users to DO MORE WITH QUICK-GRIP™.

HEAVY-DUTY ONE-HANDED BAR CLAMPS



NEW QUICK-CHANGE™
BUTTON

NEW REMOVABLE
SWIVEL JAWS &
NON-MARRING PADS

NEW

HEAVY-DUTY ONE-HANDED BAR CLAMPS

The IRWIN® QUICK-GRIP® Heavy-Duty One Handed Bar Clamp evenly distributes up to 272kg (600 lbs.) of sustained clamping pressure and is one of the top performing One-Handed Bar Clamps available. Ideal for heavy-duty applications such as installation, demolition and rough glue-up.



1. **NEW QUICK-CHANGE™ BUTTON**
Provides easy removal of jaws for accessory installation or conversion to a spreader
2. **NEW REMOVABLE SWIVEL JAWS & NON-MARRING PADS**
Full-faced pads deliver even distribution of clamping force
3. **ONE-HANDED QUICK-RELEASE TRIGGER**
New grip and trigger design provides simple, one-handed operation
4. **HEAT-TREATED, BLACK OXIDE CARBON STEEL I-BEAM**
Support added pressure with less bend and flex for superior durability
5. **ADJUSTABLE FOOT**
Provides added support allowing clamp to sit upright on table or work surface

272 kg

SUSTAINED CLAMPING FORCE

HEAVY-DUTY ONEHANDED BAR CLAMPS



PART No.	DESCRIPTION	SPREADING CAPACITY	THROAT DEPTH	EAN	PBQ
10505942	150mm (6") Heavy-Duty Bar Clamp/Spreader	235mm - 378mm 9-1/4" - 14-7/8"	92mm / 3-5/8"	5706915059427	2
10505943	300mm (12") Heavy-Duty Bar Clamp/Spreader	235mm - 530mm 9-1/4" - 20-7/8"	92mm / 3-5/8"	5706915059434	2
10505944	450mm (18") Heavy-Duty Bar Clamp/Spreader	235mm - 683mm 9-1/4" - 26-7/8"	92mm / 3-5/8"	5706915059441	2
10505945	600mm (24") Heavy-Duty Bar Clamp/Spreader	235mm - 835mm 9-1/4" - 32-7/8"	92mm / 3-5/8"	5706915059458	2
10505946	900mm (36") Heavy-Duty Bar Clamp/Spreader	235mm - 1140mm 9-1/4" - 44-7/8"	92mm / 3-5/8"	5706915059465	2
10505947	1250mm (50") Heavy-Duty Bar Clamp/Spreader	235mm - 1496mm 9-1/4" - 58-7/8"	92mm / 3-5/8"	5706915059472	2

QUICK-GRIP

MEDIUM-DUTY ONE-HANDED BAR CLAMPS

NEW

NEW QUICK-CHANGE™ BUTTON

NEW REMOVABLE SWIVEL JAWS & NON-MARRING PADS

HEAT-TREATED, BLACK OXIDE CARBON STEEL I-BEAM

ONE-HANDED QUICK-RELEASE TRIGGER

MEDIUM-DUTY ONE-HANDED BAR CLAMPS

The IRWIN® QUICK-GRIP™ Medium-Duty One-Handed Bar Clamp evenly distributes up to 136kg (300 lbs) of sustained clamping force. Ideal for temporary hold-down, quick clamping applications



- 1. NEW QUICK-CHANGE™ BUTTON**
Provides easy removal of jaws for accessory installation or conversion to a spreader
- 2. NEW REMOVABLE SWIVEL JAWS & NON-MARRING PADS**
Full-faced pads deliver even distribution of clamping force
- 3. ONE-HANDED QUICK-RELEASE TRIGGER**
New grip and trigger design provides simple, one-handed operation
- 4. HEAT-TREATED, BLACK OXIDE CARBON STEEL I-BEAM**
Support added pressure with less bend and flex for superior durability

136 kg
SUSTAINED CLAMPING FORCE

MEDIUM-DUTY ONEHANDED BAR CLAMPS



PART No.	DESCRIPTION	SPREADING CAPACITY	THROAT DEPTH	EAN	PBQ
T506QCEL7	150mm (6") Medium-Duty Bar Clamp/Spreader	200mm - 340mm 7-7/8" - 13-3/8"	81 mm / 3-3/16"	5706915000061	5
T512QCEL7	300mm (12") Medium-Duty Bar Clamp/Spreader	200mm - 590mm 7-7/8" - 19-3/8"	81 mm / 3-3/16"	5706915000078	5
T518QCEL7	450mm (18") Medium-Duty Bar Clamp/Spreader	200mm - 645mm 7-7/8" - 25-3/8"	81 mm / 3-3/16"	5706915000085	5
T524QCEL7	600mm (24") Medium-Duty Bar Clamp/Spreader	200mm - 795mm 7-7/8" - 31-3/8"	81 mm / 3-3/16"	5706915000092	5
T536QCEL7	900mm (36") Medium-Duty Bar Clamp/Spreader	200mm - 1120mm 7-7/8" - 43-3/8"	81 mm / 3-3/16"	5706915000108	5

CLAMPS

MEDIUM-DUTY ONEHANDED BAR CLAMPS



- Evenly Distributes Up To 63kg (140 Lbs.) Of Sustained Clamping Force
- Ideal For Light-duty Applications Like Woodworking And A Variety Of Smaller Projects
- Non-marring Full-face Pads Protect Work Surfaces
- One-handed Quick-release™ Trigger

PART No.	DESCRIPTION	THROAT DEPTH	EAN	PBQ
T546EL7	150mm (6") Mini Clamp	2-7/16" / 62mm	5715110790585	5

MEDIUM-DUTY ONEHANDED BAR CLAMPS



- EVENLY DISTRIBUTES UP TO 63kg (140 lbs.) of sustained clamping force
- IDEAL FOR LIGHT-DUTY APPLICATIONS like woodworking and a variety of smaller projects
- NON-MARRING FULL-FACE PADS protect work surfaces
- ONE-HANDED QUICK-RELEASE™ TRIGGER

PART No.	DESCRIPTION	THROAT DEPTH	EAN	PBQ
T53006EL7	115mm (4.5") Micro Clamp	1-3/16" / 30mm	5715110790547	10



CLAMPS

CLAMPS

ONE-HANDED BAR CLAMP ACCESSORIES

The new IRWIN® QUICK-GRIP® One-Handed Bar Clamps are designed to be compatible with the new line of One-Handed Bar Clamp Accessories. The chart below outlines which accessories fit which of the newly designed clamps and which accessories can also be used with the previous generation of IRWIN® QUICK-GRIP® One-Handed Bar Clamps.



Edge Clamping



Wider Clamping Pressure



Corner Clamping



Table Clamping



Coupling (Medium-Duty)



Coupling (Heavy-Duty)



Deck Building



Parallel Clamping

EDGE CLAMP



PART No.	DESCRIPTION	APPLICATION INFORMATION	EAN	PBQ
1988919	Edge Clamp	Converts One-Handed Bar Clamp into an edge clamp for easy clamping of trim and edging	5706919889198	5

COUPLERS



PART No.	DESCRIPTION	APPLICATION INFORMATION	EAN	PBQ
1988920	Medium-Duty Clamp	Converts One-Handed Bar Clamp into an edge clamp for easy clamping of trim and edging	5706919889198	5
1988931	Heavy-Duty Clamp	Clamp Coupler Connects the bars of two shorter One-Handed Bar Clamps to create one longer clamp	5706919889310	5

HOLD DOWN JIG



PART No.	DESCRIPTION	APPLICATION INFORMATION	EAN	PBQ
1988932	Hold Down Jig	Converts One-Handed Bar Clamp into a table clamp	5706919889327	5

WIDE PADS



PART No.	DESCRIPTION	APPLICATION INFORMATION	EAN	PBQ
1988933	Wide Pads	Double the width of standard pads to distribute clamping force onto a wider surface area	5706919889334	5

CORNER CLAMP



PART No.	DESCRIPTION	APPLICATION INFORMATION	EAN	PBQ
1988935	Corner Clamp Pads	Converts One-Handed Bar Clamp into a corner clamp for easy clamping of 90° angles	5706919889198	5

DECK TOOL



PART No.	DESCRIPTION	APPLICATION INFORMATION	EAN	PBQ
1988934	Deck Tool Kit	Converts One-Handed Bar Clamp into a deck clamp for easy, accurate spacing, aligning and holding during deck building	5706919889198	5

CLAMP STAND



PART No.	DESCRIPTION	APPLICATION INFORMATION	EAN	PBQ
1988936	Clamp Stand	Converts One-Handed Bar Clamp for level clamping; ideal for parallel clamping applications such as frames, caseworks and drawers	5706919889198	5

Accessories Selection Guide

			
1988919	Edge Clamp Medium-Duty	✓	
1988920	Clamp Coupler Heavy-Duty	✓	
1988931	Clamp Coupler		✓
1988932	Hold Down Jig	✓	✓
1988933	Wide Pads	✓	✓
1988934	Deck Tool Kit	✓	
1988935	Corner Clamp Pads	✓	✓
1988936	Clamp Stand	✓	✓

CLAMPING TOOLS SELECTION GUIDE

ONE-HANDED BAR CLAMPS



CLAMPS & SPECS	MICRO	MINI	MEDIUM-DUTY	HEAVY-DUTY
Holding Force	15 kg / 35 lbs	63 kg / 140 lbs	136 kg / 300 lbs	272 kg / 600 lbs
Clamp Capacity	115 mm	150 - 300 mm	150 - 900 mm	150 - 1250 mm
Throat Depth	30mm (1-3/16")	62mm (2-7/16")	81 mm (3-3/16")	92mm (3-5/8")
Spreading Capacity	-	-	200mm - 1120mm (7-7/8" - 43-3/8")	235mm - 1496mm (9-1/4" - 58-7/8")
Crafts / light-duty clamping	●	●	◐	
Temporary hold-down quick clamping	●	●	●	●
Flat panels / Solid edge wood glue-up / Deep-reach clamping				◐
Irregular shape / Multiple surface Corner joining			◐	◐
Installation / Demolition / Heavy-duty clamping			◐	●

○ Good ◐ Better ● Best



TRADITIONAL CLAMPS

HEAVY-DUTY PRO CLAMP L WITH TOMMY BAR



Bar Dimension 35 x 9 mm

- Drop-forged steel frame for strength and durability
- Swivel shoe helps clamping on uneven surfaces
- Twin-start Acme cold rolled thread for faster operation
- Fused steel handle will bend before the clamp can be over stressed

PART No.	DESCRIPTION	CLAMP CAPACITY	EAN	PBQ
10503574	Pro Clamp L, 400mm	16" / 400mm	5706915035742	3
10503575	Pro Clamp L, 600mm	24" / 600mm	5706915035759	3
10503576	Pro Clamp L, 800mm	32" / 800mm	5706915035766	3
10503577	Pro Clamp L, 1000mm	40" / 1000mm	5706915035773	3
10503578	Pro Clamp L, 1250mm	50" / 1250mm	5706915035780	3
10503579	Pro Clamp L, 1500mm	60" / 1500mm	5706915035797	3

GENERAL PURPOSE CLAMPS



- Drop-forged steel frame for strength and durability
- Swivel shoe helps clamping on uneven surfaces
- Twin-start Acme cold rolled thread for faster operation
- Fused steel handle will bend before the clamp can be over stressed

PART No.	DESCRIPTION	CLAMP CAPACITY	EAN	PBQ
T1203	General Purpose G-Clamp	3" / 75mm	0734442031086	4
T1204	General Purpose G-Clamp	4" / 100mm	0734442031208	4
T1206	General Purpose G-Clamp	6" / 150mm	0734442031321	4
T1208	General Purpose G-Clamp	8" / 200mm	0734442031444	1
T12010	General Purpose G-Clamp	10" / 250mm	0734442031567	1
T12012	General Purpose G-Clamp	12" / 300mm	0734442031680	1

MaxSteel™ C - CLAMPS

STANLEY

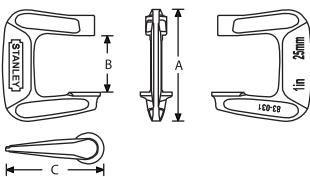

- High-visibility, corrosion-resistant finish
- Advanced frame design resists flexing & bending
- Heavy-duty malleable iron & steel construction
- Roll-formed screw threads ensure smooth operation & durability
- Oversized "T" handle for extra torque

PART No.	DESCRIPTION	L(IN)	L(MM)	CLAMPING FORCE (kn)	A(MM)	B(MM)	C(MM)	PBQ
0-83-031	MaxSteel™ C Clamp 25mm	1 x 1-3/16	30 x 25	2	70	36	65	12
0-83-032	MaxSteel™ C Clamp 50mm	2 x 1-5/16	33 x 50	5.5	102	60.5	71	12
0-83-033	MaxSteel™ C Clamp 75mm	3 x 2-1/4	57 x 75	9.5	147	90	100	6
0-83-034	MaxSteel™ C Clamp 100mm	4 x 3	75 x 100	9.5	287	113	132	6
0-83-035	MaxSteel™ C Clamp 150mm	6 x 3-1/2	89 x 150	12	256	168	158	6



MECHANICS VICE - HEAVY-DUTY RANGE

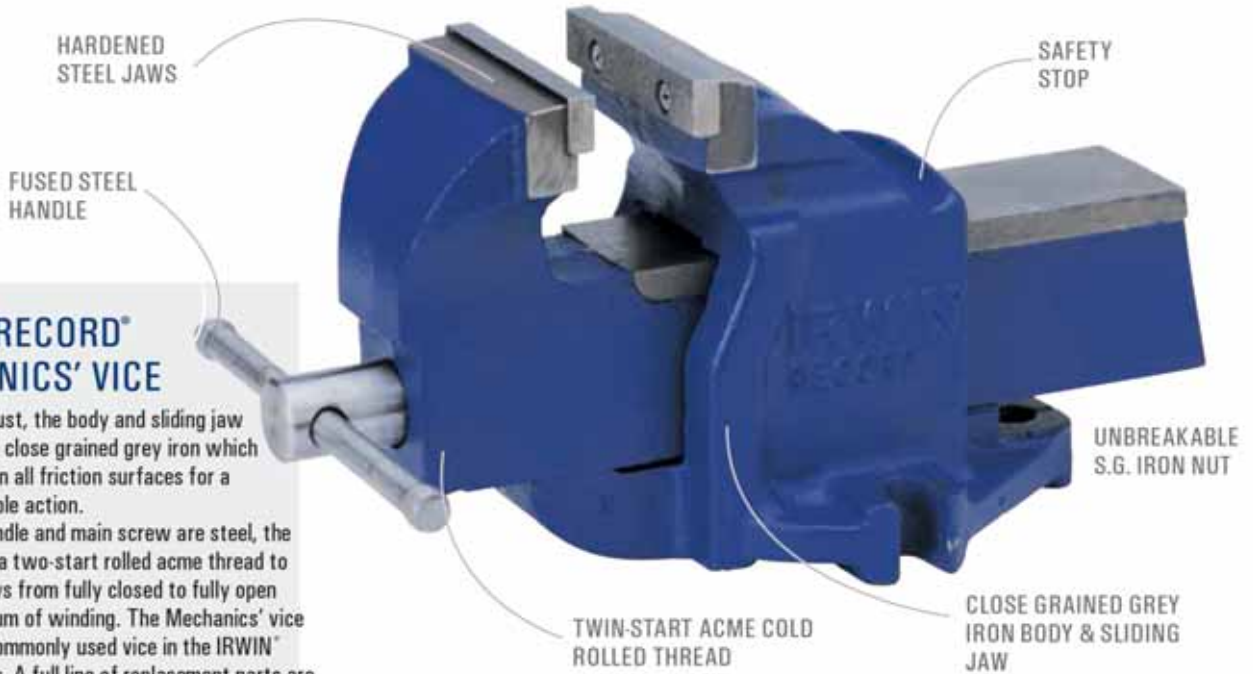

IRWIN® RECORD® MECHANICS' VICE

Rigid and robust, the body and sliding jaw are cast from close grained grey iron which is machined on all friction surfaces for a smooth, reliable action.

The jaws, handle and main screw are steel, the latter having a two-start rolled acme thread to speed the jaws from fully closed to fully open with a minimum of winding. The Mechanics' vice is the most commonly used vice in the IRWIN® Record® range. A full line of replacement parts are available.



1. **CLOSE GRAINED GREY IRON BODY & SLIDING JAW**
Cast then machined on all friction surfaces for a smooth, reliable action
2. **SAFETY STOP**
Prevents the slide from being separated from the body
3. **HARDENED STEEL JAWS**
Extend the life of the jaws and are replaceable
4. **UNBREAKABLE S.G. IRON NUT**
Can be replaced when worn
5. **FUSED STEEL HANDLE**
Will bend before the vice can be overstressed
6. **TWIN-START ACME COLD ROLLED THREAD**
For faster and smoother operation

GENERAL PURPOSE CLAMPS

- Designed for use with drill presses and pillar drills
- Unique swivel jaw for any shaped workpiece
- Precision-machined base and face for stable horizontal or vertical mounting
- Horizontal and vertical V-Grooved jaws provide excellent grip when clamping pipes
- Cross-drilled handle with tommy bar for extra leverage

PART No.	DESCRIPTION	SIZE	EAN	PBQ
3	No 3, Mechanics' Vice	4" / 100mm	0734442000488	1
5	No 5, Mechanics' Vice	5" / 125mm	0734442000723	1
6	No 6, Mechanics' Vice	6" / 150mm	0734442000846	1



STANLEY®

HAMMERS CHISELS & PUNCHES



**CLAW HAMMERS
SOFT FACE HAMMERS, RUBBER MALLET
BALL PEIN & SLEDGE HAMMERS**

POUND NAILS NOT ARMS

CLAW HAMMER



Claw Hammer
Driving and pulling common nails. *NOT masonry nails

FACE Mallet



Face Mallet
Striking metal against metal without surface damage

BALL PEIN HAMMER



Ball Pein Hammer
Used by engineers to strike a cold chisel when cutting metal or to bend and shape metal

RUBBER Mallet



Rubber Hammer
For use on soft surfaces that need to be protected such as wooden floors, tiles and furniture surfaces

TERMINOLOGY OF HAMMER



HAMMERS

STANLEY® has offered the world a great selection of striking tools for over 150 years, securing its place as one of the world's premier makers of high quality hammers.

Extensive tests for quality control are conducted on each product range, giving users the best in safety and efficiency.

Major technological advances have been made, including striking accuracy, reduced arm torsion and decreased arm damaging vibrations.

CLAW HAMMER

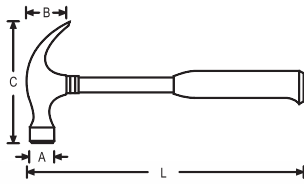

- Fully heat treated carbon steel head for strength, durability and safety
- Soft grip ergonomic handle for comfort and grip
- 5 tonne force fit head to handle assembly for improved safety
- Seamless, oval, tubular steel shaft for strength and balance

PART No.	DESCRIPTION	WEIGHT	PBQ
51-152	Claw Hammer Steel Shaft	220gms / 8	6
51-158	Claw Hammer Steel Shaft	560gms / 20	6



WOOD HANDLE NAIL HAMMER

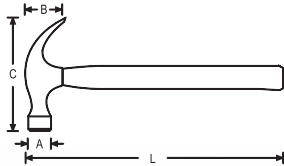

- Forged high-carbon steel head provides durability
- Fully heat-treated and polished bell face
- Light weight wooden handle

PART No.	DESCRIPTION	WEIGHT	PBQ
51-159	Wood Handle Nail Hammer	450gms/ 16	6



FIBREGLASS NAIL HAMMER

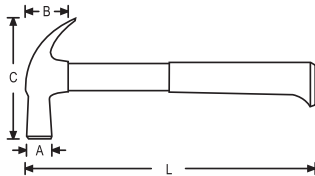

- Fibreglass core adds strength and durability to the handle
- Yellow-colored shaft for easy product visibility
- Exclusive rim temper reduces incidences of chipping or spalling

PART No.	DESCRIPTION	WEIGHT	PBQ
51-186	Fibreglass Nail Hammer	450gms / 16	6
51-187	Fibreglass Nail Hammer	560gms / 20	6



CAMP AXE



- Fully hardened and tempered carbon steel head for long life
- Ergonomic, non-slip, solvent resistant grip
- Heat treated seamless tubular steel shaft for improved safety
- Protective head cover with belt clip

PART No.	DESCRIPTION	SIZE	PBQ
54-105	Camp Axe Steel Shaft	560gms / 20	6

BALL PEIN HAMMER



- Ball end used for riveting, and poll used for normal striking
- The hammer head is attached with two wedges for improved durability
- Exclusive rim temper reduces incidences of chipping or spalling

PART No.	DESCRIPTION	WEIGHT	PBQ
54-106	Ball Pein Hammer	110gms/ 4	6
54-107	Ball Pein Hammer	220gms/ 8	6
54-111	Ball Pein Hammer	340gms/ 12	6
54-114	Ball Pein Hammer	450gms/ 16	6
54-115	Ball Pein Hammer	680gms/ 24	4
54-118	Ball Pein Hammer	900gms/ 32	4



SOFT FACE HAMMER

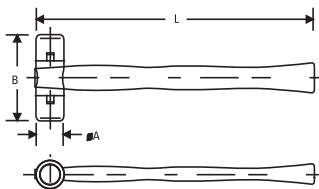

- Soft surface helps minimize marring and surface damage
- Faces are made of durable plastic that is ideal for fine finished surfaces
- Plastic faces are replaceable

PART No.	DESCRIPTION	L(MM)	A(MM)	B(MM)	HANDLE	PBQ
57-054	22mm Soft Face Mallet				Wood	6
57-055	28mm Soft Face Mallet	280	28	82	Wood	6
57-056-23	35mm Soft Face Mallet	305	35	92	Wood	6
57-057	45mm Soft Face Mallet	325	45	105	Wood	6



Compo-Cast® STANDARD HEAD SOFT FACE HAMMERS



- Non sparking soft face hammers
- No exposed metal
- Soft face doesn't mar surfaces or equipment
- Steel reinforced handles provide added strength & safety resist breaking on overstrike

PART No.	DESCRIPTION	FACE DIA.	HEAD LEN	O/A LEN	WT.	PBQ
57-531	Hammer Compo Cast Std Softface	40mm	95mm	286mm	510GM-18	4
57-532	Hammer Compo Cast Std Softface	45mm	103mm	327mm	595GM-21	4

RUBBER MALLETS

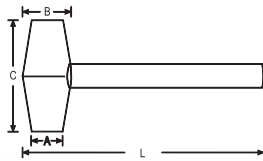

- Rubber head helps minimize marring and surface damage
- Tough rubber head molded to a wood handle
- For striking blows where steel hammers would mar or damage surface



PART No.	DESCRIPTION	L(MM)	A(MM)	B(MM)	C(MM)	HANDLE	HEAD WEIGHT	PBQ
STHT5J527-8	16oz Rubber Mallet	335	55	55	92	WOOD	450	6
STHT5J528-8	24oz Rubber Mallet	335	60	60	112	WOOD	680	6



SLEDGE HAMMER WITH HICKORY HANDLE



- Propriety shock absorption core- best in class shock absorption
- Propriety bullet head- more concentrated striking power
- New soft grip design for better grip, comfort and vibration absorption
- Shock absorbing collar – isolates vibration to the head and reduces shock
- World's 1st particle dampened handles – vibration dampening particulate handle dampens vibration better than solid core handles

PART No.	DESCRIPTION	WEIGHT	PBQ
95IB56400E	Sledge Hammer Hickory Handle	1.36kgs / 3	4
95IB56401E	Sledge Hammer Hickory Handle	1.81kgs / 4	4
95IB56608E	Sledge Hammer Hickory Handle	3.62 Kgs / 8	4
95IB56612E	Sledge Hammer Hickory Handle	5.44 Kgs / 12	2



// This Hammer has some serious power. I would definitely recommend this Hammer for first fix work. The handle is ergonomic & fits the hand brilliantly. //

HAND SAWS

HAND SAWS



In 1933, a young man by the name of Hans Schroder set up as a wholesaler in Copenhagen, Denmark. During the first few years he kept his focus on selling general hand tools, but in 1938 he started to also manufacture saws. Amongst his friends and business associates Hans Schroder was known simply as Jack, and before long, the "Jack" name had become synonymous with the production of high quality saws.

IRWIN® Jack® has been at the forefront of many advancements with the development of the market leading Jack® 880 now with upgraded ProTouch™ handle to compliment the recently upgraded universal triple ground tooth technology.



PLUS 880 UNIVERSAL HANDSAW



A JACK FOR ALL TRADES

The IRWIN® Jack® PLUS range provides best-in-class handsaws for today's trade professional. With advanced tooth technology and an ergonomic ProTouch™ grip, the PLUS range handsaws are number one for speed and ease and quality of cut. Along with these industry-leading features, the full range utilises a system of colour coded handles for easy selection.



- 1. UNIVERSAL TRIPLE GROUND TEETH**
Patented tooth grind designed to cut 25% faster
Versatile, universal teeth cut most building materials
- 2. STRONG BLADE**
High quality C75 steel is stable and ensures maximum power transfer with every stroke
- 3. PROTOUCH™ GRIP WITH FINGER REST**
With three times more elastomer for maximum soft-feel and control
- 4. OPTIMISED HAND CAPACITY**
Increased space for use with gloves and improved functionality
- 5. INCREASED GRIP CIRCUMFERENCE**
For a sturdy and robust feel
- 6. 90° & 45° ANGLES**
Integrated into handle for easy marking out

25% FASTER

ProTouch™ GRIPS

PLUS 880 UNIVERSAL SAWS



PART No.	DESCRIPTION	SIZE	HANDLE COLOUR	PBQ
10503623	Universal 880TG,	450mm / 18" 8T/9P	■	4
10503624	Universal 880TG,	500mm / 20" 8T/9P	■	4

Marples®

At the heart of quality craftsmanship lies the rich heritage of Marples® woodworking tools. Originating in 1828 in Sheffield, England, the Marples® brand has consistently stood for superior performance and ultimate precision in fine woodworking. Founder William Marples came from a long lineage of master craftsmen in the joinery and edge tool trades, and after serving as an apprentice to his father he established William Marples and Sons Limited. Using only



PART No.	DESCRIPTION	SIZE	PBQ
TM4441	M444 B/e Ch	25mm 1in	6
TM44414	M444 B/e Ch	6mm 1/4in	6
TM44434	M444 B/e Ch	19mm 3/4in	6

3 PCS. WOOD CHISEL SET



- Durable precision ground cutting edges
- Blades uniformly hardened for full length use
- Blades are also heat tempered & lacquer coated to prevent rust

PART No.	DESCRIPTION & CONTENTS	PBQ
16-089	Wood Chisel Set, 3 Pcs - 1/2 X 7 3/4, 3/4 X 7 3/4, 1 X 7 3/4	5

WOOD CHISEL SET



- Various chisel applications
- Hand carving knives in various cuts are ideal for DIY handcrafts

PART No.	DESCRIPTION
STHT16120-8	6 Pcs Wood Chisel 1/4" Set : 1 Sken Chisel, 1 Curved Gouge, 1 Curved Flat, 1 Curved U Tool, 1 Straight Gauge, 1 Square Chisel



COLD CHISEL



- One piece forged construction for strength
- Hardened, quenched, and tempered for long life
- Powder coated for easy visibility

PART No.	DESCRIPTION	SIZE	PBQ
STHT16290-8	Cold Chisel	(7/8" /22mm)	5

CENTER PUNCH



- Used for marking metal or making indications for starting drill holes
- One piece construction forged tempered tool steel for strength
- Hardened & tempered for long life

PART No.	DESCRIPTION	SIZE	PBQ
16-228	Center Punch	8mm-5/16 X 115mm-4 1/2	3

6 PC PUNCH KIT



- Used for marking metal or making indications for starting drill holes
- One piece construction forged tempered tool steel for strength
- Hardened & tempered for long life

PART No.	DESCRIPTION	SIZE	PBQ
16-226	6 Pc Punch Kit	1/16", 1/8", 5/32", 3/16", 1/4", 5/16"	3

12 PC PUNCH & CHISEL KIT



- Accessible packaging enables the customer to easily evaluate products in store
- One-piece construction forged for strength
- Hardened, quenched and tempered for long life and durability

PART No.	DESCRIPTION & SIZE	PBQ
16-299	Center 1/4", 5/16", Starter 3/32", Pin 1/16", 1/8", 5/32", 3/16", 1/4", 5/16", Prick 3/8", Cold Chisel, 1/2", Cold Chisel, 5/8"	3



STANLEY®

SPECIALITY TOOLS



3 JAW PULLERS

FEELER GAUGE, OIL FILTER WRENCH

12-IN-1 MULTI TOOL, SCREW EXTRACTOR

BOTTLE JACKS

A PROFESSIONAL CHOICE FOR EVERY TASK



3 JAW PULLER



- The high quality chrome vanadium steel material, puller fingernail to pass through the special heat treatment.
- Durable
- The user-friendly design, comfortable to use.
- Suitable in the demolition automobile profession & the industry profession bearing, the gear & so on

PART No.	DESCRIPTION	SIZE	PULLING FORCE	PBQ
70746-S	3 Jaw Gear Puller	75mm / 3	1.5 ton	1
70747-S	3 Jaw Gear Puller	100mm / 4	3.5 ton	1
70748-S	3 Jaw Gear Puller	150mm / 6	5.0 ton	1
70875-S	3 Jaw Gear Puller	200mm / 8	15.0 ton	1
70876-S	3 Jaw Gear Puller	250mm / 10	18.0 ton	1
70877-S	3 Jaw Gear Puller	300mm / 12	22.0 ton	1

25 BLADES FEELER GAUGE



- Standard type feeler gauge with blades fold into metal case.
- 25 precision blades sizes form 0.04mm to 1.00mm
- High grade stainless steel with anti rust

PART No.	DESCRIPTION	SIZE	WT.(g)	PBQ
70115-S	METRIC FEELER GAUGE - 25 BLADES	0.04, 0.05, 0.06, 0.07, 0.08, 0.09, 0.10, 0.15, 0.20, 0.25, 0.30, 0.35, 0.40, 0.45, 0.50, 0.55, 0.60, 0.65, 0.70, 0.75, 0.80, 0.85, 0.90, 0.95, 1.00MM	125	10



OIL FILTER WRENCH (STRAP TYPE)

- 16 inches High strength Nylon Strap



PART No.	DESCRIPTION	SIZE	PBQ
997694-S	Oil Filter Wrench Strap Type	50-108mm	1



SCREW EXTRACTORS

- Uses the Cr-Mo steel after the heat treatment
- The fast convenient disassemblage of screw, pipe, bolt & stud & so on

PART No.	DESCRIPTION	SIZE	PBQ
94-171	5 Pc. Extractors Set	3, 6, 8, 11, 14mm	5



CROSS WRENCH

- Chrome Vanadium Steel
- Cross type structure
- Convenient operation
- Greater torque
- Labor-saving



PART No.	DESCRIPTION	SIZE	PBQ
STMT94030-8	Cross Wrench	17, 19, 21, 23mm	1



MULTI TOOLS - 12-IN-1 PLIERS

PART No.	DESCRIPTION	PBQ
1-84-519	Long Nose Pliers, Curve Jaw Pliers, Wire Cutter, Saw, Phillips® Screwdriver, Standard Screwdrivers (1/4", 5/16", 1/8"), Small Knife, Large Knife, Bottle Opener	12



HYDRAULIC TOOLS - BOTTLE JACK

- Lifting height range from 7-1/8 to 14-12 (181-370mm)
- Capacity range from 8000kg to 50000 kg (8 ton - 50 ton)
- Precise hydraulic assembly and piston for fine maximum adjustment
- Heavy-duty construction for extra strength and safety
- Safety bypass flow valve
- Adjustable screw top with lifting cap grooved for improved load gripping
- Meet CE Specifications
- Innovative design offers a quicker lift for professional performance in Automotive / General Industry application

PART No.	DESCRIPTION	CAPACITY	LIFTING HEIGHT		N.W G.W KG	PBQ
			MIN.	MAX.		
ST90801CE	Bottle Jack	8000kg/ 8	230	457	6.3 / 6.6	1
ST92001CE	Bottle Jack	20000kg/ 20	242	452	11.5 / 11.9	1
ST-93001CE	Bottle Jack	30000kg/ 30	285	465	21 / 21.7	1
ST-95001CE	Bottle Jack	50000kg/ 50	300	485	34	1



// I WAS SURPRISED AT JUST HOW MUCH THIS HAMMER ABSORBS THE SHOCK AND VIBRATION. A MUST FOR ANYONE WHO SUFFERS WITH THE EFFECTS OF VIBRATION WHEN USING HAMMERS. //

STANLEY®

TOOL STORAGE



**METAL STORAGE
PLASTIC TOOL BOX
NYLON TOOL BAG**

PRACTICAL STORAGE SOLUTIONS

**TRANS
MODULE**
system



TOOL BOXES



STANLEY® offers a full line of plastic and metal tool box solutions to satisfy virtually any tradesman, machinist, technician or DIYer. These tool boxes come in various sizes and designs and are made with long-lasting materials such as heavy-duty structural foam, high-impact plastic and a combination of plastic and metal.

TOOL BAGS



The STANLEY® range of soft storage options is intuitive and contemporary. Portable tool storage options such as pouches and tool belts feature easy access compartments and pockets made from heavy duty materials. From soft sided tool bags, to totes with multiple pockets and compartments, this range offers maximum tool organization.

TOOL TROLLEYS



Built to store large volumes, this range was designed with durability and convenience in mind. As the pioneer in this category, STANLEY® offers a range of inventive high mobility storage solutions, offering accessibility and ease.

7 DRAWER WORKSTATION

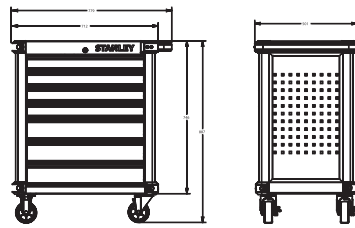

- Multiple drawer sizes for flexible storage options
- Perforated side panels for more storage options
- Ball bearing slides for smooth and heavy loading drawer operation
- Lockable castors
- PVC bumpers on corners
- Lockable drawers



COMPATIBLE with
**TRANS
MODULE**
system

PART No.	DESCRIPTION	OVERALL DIMENSION (L X W X H MM)	EFFECTIVE DRAWER DIMENSION (MM)	TOTAL LOAD CAPACITY (KG)	DRAWER LOAD CAPACITY (KG)	Drawer Qty.
STST74306-8	7 Drawer Roller Cabinet	690 x 426 x 889	Top 4: 540 x 408 x 72 Bottom 3: 540 x 408 x 105	300	20	7

7 DRAWER WORKSTATION

- Electro-powder coating to resist scratch & solvent markings
- Ball bearing slide with quick disconnect
- Double wall construction with heavy duty metal side handle to provide ultimate durability
- Full-length drawer pulls with liners & top vinyl mat included
- Heavy duty 5 x 2 inches casters & easy grip cabinet side handle for better mobility



PART No.	DESCRIPTION	OVERALL DIMENSION (L X W X H MM)	EFFECTIVE DRAWER DIMENSION (MM)	TOTAL LOAD CAPACITY (KG)	DRAWER LOAD CAPACITY (KG)	Drawer Qty.
93-547-23ID	7 Drawer Roller Cabinet	680 x 458 x 995	Top 5: 570 x 410 x 75 Bottom 2: 570 x 410 x 154 540 x 408 x 105	300 400	20 20	7 7



4 DRAWERS ROLLER CABINET WITH ABS TOP TRAY

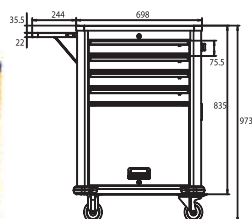

- Ball bearing slides for smooth and heavy loading drawer operation
- ABS top tray
- Side folding shelf
- Lockable wheel with rubber castors
- Side can and screwdriver holders
- Rubber bumpers on corners
- Lockable drawers



COMPATIBLE with
**TRANS
MODULE**
system

PART No.	DESCRIPTION	Overall Dimension (L x W x H mm)	Effective Drawer Dimension (mm)	Total Load Capacity (kg)	Drawer Load Capacity (kg)	Compartment Load Capacity (kg)	PBQ
STMT99069-8	4 Drawers Roller Cabinet	698 x 477 x 973	536 x 410 x 75.5	300	25	35	1

5 TRAY CANTILEVER BOX

- Electro-powder coating to resist scratch & solvent markings
- Heavy duty metal for body construction & handle to provide ultimate durability
- Double latch for greater strength Tray swing out for easy tool access
- Double Handle for more comfort



PART No.	DESCRIPTION	SIZE	PBQ
1-94-738	Cantilever Tools Box 5 Tray Double Handle	460x200x200mm	1

19" METAL TOOL BOX - 1 DRAWER

- One-hand operation
- Long handle
- Auto sliding drawer

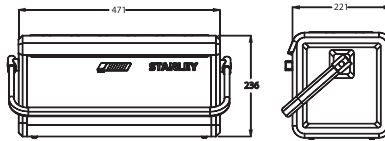

PART No.	DESCRIPTION	Overall Dimension (L x W x H mm)	Effective Drawer Dimension (mm)	Total Load Capacity (kg)	Drawer Load Capacity (kg)	Compartment Load Capacity (kg)	PBQ
STST73100-8	19" Metal Tool Box - 1 Drawer	471 x 221 x 236	403.8 x 184 x 77	4.5	20	4.5	1

* Tools not included

COMPATIBLE with
**TRANS
MODULE**
system



400MM / 16" ESSENTIAL TOOL BOX WITH METAL LATCH

- Organizer on lid
- Internal tray

PART No.	DESCRIPTION	L(MM)	W(MM)	H(MM)	WT.(KG)	LATCH	PBQ
STST1-75518	16" Essential Tool Box With Metal Latch	406	205	195	0.83	Metal	6



400MM / 16" PLASTIC TOOL BOX

- Imported new pattern double colour plastic aesthetic impact
- Lock button using the metal material nickel plating accomplished durable strong lock
- The product does not include tools & accessories of pictures

PART No.	DESCRIPTION	SIZE	PBQ
1-92-905	Plastic Tool Box	400x254x183mm	6



480MM / 19" PLASTIC TOOL BOX

- Imported new pattern double colour plastic aesthetic impact
- Imported new pattern double colour plastic aesthetic impact
- Lock button using the metal material nickel plating accomplished durable strong lock

PART No.	DESCRIPTION	SIZE	PBQ
1-92-906	Plastic Tool Box	486x270x237mm	1



560MM / 22" PLASTIC TOOL BOX

- Imported new pattern double colour plastic aesthetic impact
- Lock button using the metal material nickel plating accomplished, durable, strong lock
- The product does not include tools & accessories of pictures

PART No.	DESCRIPTION	SIZE	PBQ
1-92-908	Plastic Tool Box	565x315x282mm	1



WATER-PROOF NYLON TOOL BAG - SMALL

- High grade water proof nylon material
- Durable & easy to carry about
- Unique design, convenience of use



PART No.	DESCRIPTION	SIZE	PBQ
93-222	Nylon Tool Bag, Water Proof	100x170x250	1

WATER-PROOF NYLON TOOL BAG - MEDIUM

- High grade water proof nylon material
- Durable & easy to carry about
- Unique design, convenience of use



PART No.	DESCRIPTION	SIZE	PBQ
93-223	Nylon Tool Bag, Water Proof	230x300x300mm	1

WATER-PROOF NYLON TOOL BAG - LARGE

- High grade water proof nylon material
- Durable & easy to carry about
- Unique design, convenience of use



PART No.	DESCRIPTION	SIZE	PBQ
93-224	Nylon Tool Bag, Water Proof	450x230x300mm	1

WATER-PROOF NYLON TOOL BAG - BIG

- High grade water proof nylon material
- Durable & easy to carry about
- Unique design, convenience of use

PART No.	DESCRIPTION	SIZE	PBQ
93-225	Nylon Tool Bag, Water Proof	650x230x300mm	1



300MM / 12" OPEN MOUTH BAG

- Multiple internal and external pockets
- Durable body material

PART No.	DESCRIPTION	SIZE	PBQ
STST512114	300mm / 12" Open Mouth Bag	L 300 X W 225mm	4



16" OPEN MOUTH BAG

- Adjustable shoulder strap
- Strong reinforced plastic base
- Free standing open mouth

PART No.	DESCRIPTION	MATERIAL	# OF POCKETS OUTSIDE	LXHXW	WEIGHT (KG)	PBQ
STST516126	16" Open Mouth Bag	600 Denier Polyester	5	450 x 275 x 235	1.1	1

* Tools not included



BACK PACK ON WHEELS



- Combines a mix of on wheels and on back carriage for easy and convenient tool transporting
- Removable divider with multiple pockets for a wide variety of tools
- Rigid form that can stand in an open position enabling easy access to all tools
- Separate and strong compartment for power tool or laptop
- Dual zipper closure enables opening from every end

PART No.	DESCRIPTION	MATERIAL	LxHxW	WEIGHT (g)	# OF POCKETS OUTSIDE	# OF POCKETS IN	PBQ
FMST51419	Fatmax® Tools Backpack On Wheels	600 Denier Polyester	360x230x540	3.3	29	4	2

* Tools not included



TOOL APRON



- Multiple size pockets & loops: dedicated tape & hammer storage
- Adjustable belt & padded back

PART No.	DESCRIPTION	MATERIAL	L(MM)	W(MM)	H(MM)	WT.(MM)	#OF POCKETS INSIDE	PBQ
STST511304	Tool Apron	600 Denier Polyester	600	75	255	0.7	11	2

* Tools not included

TOOL BAG STORAGE LINE



OPEN BULKY STRUCTURE DESIGN
Easy access to tools

600X600 DENIER FABRIC
Hardwearing, strong and durable

STRONG REINFORCED PLASTIC BASE
Protection from wet and damp surfaces

FREE STANDING OPEN MOUTH
Non collapsible enables easy access to tools at all times

MULTIPLE INTERNAL AND EXTERNAL POCKETS
Maximum organization potential

COVERED FRONT POCKET
Secure storage of small parts or personal items

TOOLS THAT BUILD THE WORLD

STANLEY[™]

Hand Tools for general/ industrial purpose applications and Power tools for Tradesman

DEWALT[®]

Professional Power Tools

**BLACK+
DECKER**[™]

Consumer/ DIY Power Tools

IRWIN[®]

Professional Hand Tools, Power tools and accessories

LENOX[®] 

Professional grade cutting tools and accessories

 **FACOM**[®]

Professional/ Critical applications Hand Tools

PROTO[®]

Professional/ Critical applications Hand Tools

STANLEY BLACK & DECKER INDIA PVT.LTD
28 Akemps, 3rd Main, 1st Cross, Ashwini Layout,
Koramangala, Intermediate Ring Road,
Bangalore - 560 047

T: +91 80 6791 9900 • F: +91 80 6660 8828
E: sbd-customercommunications@sbdinc.com

CAT- SW0001

STANLEY

DEWALT

BLACK+DECKER

FACOM

PROTO

IRWIN

LENOX