



Turnkey Manufacturing

FOR EDUCATION & INDUSTRY

Test, Measuring, Vocational,
Didactic, Educational Training
Equipment, LMS & Workshop Tools

About us

Company Profile

Tesca Technologies Pvt. Ltd. is World's Leading ISO & CE Certified Manufacturer & Exporter of Test, Measuring, Vocational, Didactic, Educational Training Equipment, LMS & Workshop Tools & Machines. Member for Electronics & Computer Software Export Promotion Council, New Delhi, India having sales in more than 85+ Countries Worldwide. Tesca's operations are spread out in 23000 Square Feet encompassing more than 3000 manufactured Innovative Products and Turnkey Project Capabilities for International Tenders. Tesca is an Export House established in December 2009 with our Registered & Corporate Office both set up at Jaipur. We are actively doing business in Middle East, CIS, South East Asia, Africa as well as South America Countries. We have our representatives in almost all Countries. Please be noted that we are doing projects meant for School Education, Vocational Training, Laboratory, Health Center, Hospital Equipment, Agricultural Modernization, Industrial Modernization, Rural Water Supply as well as Small Scale Enterprises funded by Ministry of Education, World Bank, Asian / African Development Bank as well as GOI LOC.



Corporate Office



Production Floor



Conference Hall



Products Showroom



Reception



Purchase Division

Tesca At A Glance:

- ISO & CE Certified Manufacturer & Exporter of TVET, Skill Development for Education & Industry
- Member of ESC, Electronics & Computer S/W Export Promotion, Delhi, India
- Member of Worlddidac Association, Switzerland
- 23000 Sq. Feet of Operations
- 5000 Innovative Products, "You Name It & We Have It"
- Turnkey Projects for International, World Bank, AFDB, ADB, UNDP, FAO Tenders
- Amongst top most Qualified & Reputed Exporter in India
- Sales to more than 85+ countries, Your Sourcing Partner in India
- Worldwide Installation/ Exhibitor in Africa, Dubai, Switzerland, Hong Kong

Quality:

Our products are accepted across global market. The prime reason for such widespread acceptance is an undying pledge to quality. To actualize and maintain such quality levels, we adhere to international quality management system. Our products are tested by our technical experts in various stages of production to ensure 100% quality. A devoted team of quality experts are entrusted with this job and they ensure that our products are in line with the global standards.

Mission:

Be the World's Leading Manufacturer & Exporter of TVET, Skill Development, Bridge Gap between Industries & Institutes, Vocational Training by imparting Environment Friendly Technologies, Solutions and Innovations to make a Better World.

Vision

Contribute towards United Nation's Sustainable Development Goals of Quality Education, Industry, Innovation & Infrastructure.



CE Certificate

ESC Certificate

IVETA Member

Worlddidac Member

ISO Certificate

CONTENTS

A.	Educational Trainer / Software	01-397
a.	Analog Electronics Trainers	01-79
b.	Antenna, Satellite, GPS, Radar, RF Trainers	80-92
c.	Bread Board Trainers	93-109
d.	Communication Trainers	110-141
e.	Consumer Electronics Trainers	142-163
f.	Digital Electronics Trainers	164-197
g.	Display Boards Trainers	198-200
h.	Microprocessor, Microcontroller, Embedded Trainers	201-224
i.	Fiber Optic Trainers	225-237
j.	Instrumentation Trainers	238-287
k.	Power Electronics & Electrical Motors/Machine Lab	288-357
L.	Microwave Test Benches	355-361
m.	Motors & Machines	362-376
n.	PCB Lab	377-378
o.	Robotic Kits / Trainers	379-393
p.	Educational Wall Charts	394-397
B.	Lab Furniture	398-399
C.	Cables & Wires	400
D.	Soldering & Desoldering Station	401-404
E.	Test & Measurement Instruments	405-420
F.	Hand / Power Tools	421-427
G.	Physics Lab	428-431
H.	Mechanics Lab	432
I.	Biology Lab	433
J.	Variacs/Dimmerstat	434
K.	IT - Computers - Networking	435
L.	Web & Software Applications	435
M.	E-Learning LMS / CMS	436-437
N.	Electronic Components	438
O.	Agri. Products	438
P.	Solar Products	439
Q.	Laboratory Plasticware	440-442
R.	Mechanical & Civil Lab	443-447

Linear IC Trainer

Order Code - 36101



Experimental Training Board has been designed specifically for the study of ten popular and most useful Linear Integrated Circuits (ICs). The capabilities of this trainer extend far beyond the experiments described. Although only a finite number of experiments have been described yet other circuits as per individuals requirements can also be designed using the available components and power supplies. Practical experience on this board carries great educative value for Science and Engineering Students.

Object:*** OP-AMP IC 741**

The following experiments can be performed :

01. To measure the quiescent supply current
02. To null the offset voltage
03. To measure open-loop voltage gain under closed loop condition.
04. To measure output resistance
05. To measure differential input resistance
06. To measure unity gain bandwidth
07. To measure the rated output
08. To measure the slewing rate
09. To measure the full power response
10. To measure input offset voltage
11. To measure input bias and offset current
12. To measure input noise voltage
13. To measure input noise current
14. To measure Common Mode Rejection Ratio (CMRR)
15. To measure Common Mode Input Resistance (CMIR)
16. Application as Inverting amplifier
17. Application as Non-inverting amplifier
18. Application as difference amplifier
19. Application as Inverting summing amplifier
20. Application as Non-inverting summing amplifier
21. Application as D.C. Voltage follower
22. Application as A.C. Voltage follower
23. Application as differentiator
24. Application as Integrator
25. Application as semi Log-amplifier
26. Application as unipolar limiter
27. Application as bipolar limiter
28. Application as positive peak clipper
29. Application as negative peak clipper
30. Application as AC-DC converter
31. Application as High Pass Filter
32. Application as Low Pass Filter
33. Application as Triangle to Sine Wave Converter
34. Application as 500Hz-5KHz Square Wave Generator
35. Application as Wien-Bridge Oscillator
36. Application as Pulse Generator
37. Application as linear to log potentiometer
38. Application as random noise generator

*** FET INPUT OP-AMP IC CA 3130**

The following experiments can be performed :

01. Application as high input impedance voltage follower
02. Application as pulse generator with independent control of ON and OFF periods
03. Application as active full wave rectifier without using diodes

*** HIGH SPEED COMPARATOR IC 710**

The following experiments can be performed :

01. To measure open loop voltage gain under closed loop condition
02. To measure output resistance
03. To measure differential input resistance
04. To measure unity gain bandwidth
05. To measure the rated output
06. To measure the slewing rate
07. To measure the full power response
08. To measure input offset voltage
09. To measure input bias and offset current
10. To measure input noise voltage
11. To measure input noise current
12. To measure Common Mode Rejection Ratio (CMRR)
13. To measure Common Mode Input Resistance (CMIR)
14. Application as a comparator
15. Application as a pulse width modulator
16. Application as a level detector
17. Application as Schmitt Trigger

*** TIMER IC NE 555**

The following experiments can be performed :

01. Application as pulse width modulator
02. Application as pulse position modulator
03. Application as linear ramp generator
04. Application as 50% duty cycle oscillator
05. Application as Monostable Multivibrator
06. Application as Astable Multivibrator
07. Application as Frequency divider
08. Application as Schmitt trigger
09. Application as Event failure alarm
10. Application as Sine to Square Wave Converter

*** FUNCTION GENERATOR IC 566**

The following experiment can be performed :

01. To study the linearity and accuracy of output waveforms

*** PHASE LOCKED LOOP IC NE 565**

The following experiments can be performed :

01. Measurement of center frequency 'fo'
02. To study Vco sensitivity and linearity
03. Measurement of capture range and lock range
04. To study locking of Vco to harmonic of input signal
05. Detection of F.M. Signal

*** FIXED VOLTAGE REGULATOR IC 7812 & IC 7912**

The following experiments can be performed :

01. To measure Line Regulation
02. To measure Load Regulation
03. To suppress oscillations at input and output
04. To study minimum input to output voltage Difference required for proper operation
05. To increase the output voltage using resistors
06. To increase the output voltage using zener diodes
07. To continuously vary the output voltage

* VARIABLE VOLTAGE REGULATOR IC 723

The following experiments can be performed :

01. To measure Line Regulation
02. To measure Load Regulation
03. To measure Ripple Rejection
04. Application as basic voltage regulator
05. Application as Low voltage regulator (2 to 7V)
06. Application as High voltage regulator (7 to 21V)
07. Application as increased current output voltage regulator Using external NPN power transistor
08. Application as fold back current limiting regulator

* VARIABLE VOLTAGE REGULATOR IC CA 3085

The following experiments can be performed :

01. To measure Line Regulation
02. To measure Load Regulation
03. To measure Ripple Rejection
04. Application as 3 to 23V variable output voltage regulator
05. Application as fixed voltage regulator
06. Application as current regulator
07. Application as High Gain Amplifier (upto 100KHz)

FEATURES

The board consists of the following built in parts :

01. 0-30V D.C. at 500mA, continuously variably unregulated Power Supply.
02. $\pm 12V$ D.C. at 250 mA, IC Regulated Power Supply.
03. $\pm 6V$ D.C. at 200 mA, IC Regulated Power Supply.
04. 1 KHz square wave signal source with variable output level.
05. 100 Hz sine wave signal source with variable output level.
06. Pulser for generating trigger pulses.
07. D.C. Ammeter, 65mm rectangular dial with switch selectable ranges of 50 mA, 250mA and 500mA.
08. D.C. Voltmeter, 65mm rectangular dial, dial with switch selectable ranges of 100mV, 1V and 40V.
09. Two toggle switches, NPN power transistor 2N 3055, Transistor BC 177, Two IC 741 Three IC 3130, IC 710, IC 723, IC 3085, IC 555, IC 566, IC 565, IC 7812, IC 7912, Electronic Load, 8 potentiometers, 45 fixed value resistors, 22 capacitors, 3 silicon signal diodes, 3 zener diodes, LED, 3 sets of 3 interconnected sockets each for multi-connections wherever required.

T and p Network Trainer

Order Code - 36102



T and p Network Trainer has been exclusively and attractively designed to demonstrate the significance of image and characteristic impedance of T and p-network. It can be used as a stand alone unit with inbuilt DC power supply. Various scope of learning makes the subject understanding complete.

This trainer includes not only the experimental calculation of image and characteristic impedance but also verifies it by comparing the theoretical values under T and p-networks in a sequential manner. With this, students can learn about importance of

Symmetrical and Unsymmetrical networks.

Experiment:

01. Study and verification of Image Impedance of Unsymmetrical T-Network
02. Study and verification of Image Impedance of Unsymmetrical p-Network
03. Study and verification of Characteristic Impedance of Symmetrical T-Network
04. Study and verification of Characteristic Impedance of Symmetrical p-Network

Technical Specifications

01. Mains Supply : 230 V $\pm 10\%$, 50 Hz
02. DC Power Supply : 5 V, 150 mA

Study of L.C. Transmission Line

Order Code - 36111



Experimental Training Board has been designed specifically to study the voltage distribution along L.C. Transmission line in the form of an Artificial Transmission line. It also helps students to study Ferranti effect, distortion-less line and velocity of propagation.

Object:

To study voltage distribution along L.C. Transmission line :

Features:

The board consists of the following built-in parts :

01. Artificial Transmission Line, consisting of 20T sections. Each section contains two R.F. chokes and one condenser with connections brought out on terminals on the front panel.
02. 16 metal connectors for connections between terminals.
 - * Adequate no. of patch cords stackable from rear both ends 4mm spring loaded plug length $\frac{1}{2}$ metre.
 - * Good Quality, reliable terminal/sockets are provided at appropriate places on panel for connections/ observation of waveforms.
 - * Strongly supported by detailed Operating Instructions, giving details of Object, Theory, Design procedures, Report Suggestions and Book References.
 - * Weight : 5 Kg. (Approx.)
 - * Dimension : W 412 x H 150 x D 310

Other Apparatus Required:

- * V.T.V.M.
- * Decade Audio Frequency Generator
- * Decade Resistance Box
- * Cathode Ray Oscilloscope 20MHz

Multimeter

Order Code - 36120

Has been designed for the study of the Multimeter. A milliammeter of the moving coil type is used to measure the voltage, current and value of resistance i.e. used as

a voltmeter, ammeter and ohmmeter respectively. Practical experience on these boards carries great educative value for Science and Engineering Students.

Object:

Use of a milliammeter as Voltmeter, Ammeter and Ohmmeter with use in following ranges :

01. As Voltmeter : 1 to 1000 V DC also 100 Volts AC.
02. As Ammeter : 1mA to 1A.
03. As ohmmeter : 0 to 100 K ohm.

Features

The board consists of the following built-in parts :

01. Ammeter of 1mA basic movement for measurement.
02. Bridge rectifier.
03. Battery of 1.5 Volt.
04. Potentiometer for adjustment.
- * Adequate no. of other electronic components.
- * Adequate no. of patch cords stackable from rear both ends 4mm spring loaded plug length ½ metre.
- * Good Quality, reliable terminal/sockets are provided at appropriate places on panel for connections/ observation of waveforms.
- * Strongly supported by detailed Operating Instructions, giving details of Object, Theory, Design procedures, Report Suggestions and Book References.

Other Apparatus Required:

01. IC Regulated Power Supply
02. Decade Audio Frequency Generator
03. Decade Resistance Box
04. Variac 0-270 Volts at 2 Amp
05. Digital Multimeter 3¾ digit

Audio Amplifier (CE)

Order Code - 36121



Experimental Training Board has been designed specifically for the study of voltage gain, frequency response, input impedance, output impedance, current gain, Power gain of a Common Emitter (CE) Transistor Audio Amplifier.

Object:

Study of Transistor Audio Amplifier (CE) :

01. To measure the Voltage Gain.
02. To plot the Frequency Response characteristics.
03. To find out the Input Impedance.
04. To find out the Output Impedance.
05. To find out the Current Gain.
06. To find out the Power Gain.

Features:

The board consists of the following built-in parts :

01. -9V D.C. at 50mA, IC regulated Power Supply internally connected.
02. PNP transistor.
- * Adequate no. of other electronic components.
- * Mains ON/OFF switch, Fuse and Jewel light.

- * The unit is operative on 230V ±10% at 50Hz A.C. Mains.
- * Adequate no. of patch cords stackable from rear both ends 4mm spring loaded plug length ½ metre.
- * Good Quality, reliable terminal/sockets are provided at appropriate places on panel for connections/ observation of waveforms.
- * Strongly supported by detailed Operating Instructions, giving details of Object, Theory, Design procedures, Report Suggestions and Book References.

Other Apparatus Required

01. Audio Frequency Generator
02. Decade Resistance Box
03. A.C. Millivoltmeter
04. Cathode Ray Oscilloscope 20MHz
05. Weight : 3 Kg. (Approx.)
06. Dimension : W 340 x H 110 x D 210

Emitter Follower (CC)

Order Code - 36122



Experimental Training Board has been designed specifically to study over all characteristics of the Emitter Follower Amplifier.

Object:

To study the over all characteristics of the Emitter Follower Amplifier and to find :

01. Voltage Gain.
02. Input Impedance.
03. Output Impedance.

Features:

The board consists of the following built-in parts :

01. +9V D.C. at 50mA, IC regulated Power Supply internally connected.
02. NPN transistor.
- * Adequate no. of other electronic components.
- * Mains ON/OFF switch, Fuse and Jewel light.
- * The unit is operative on 230V ±10% at 50Hz A.C. Mains.
- * Adequate no. of patch cords stackable from rear both ends 4mm spring loaded plug length ½ metre.
- * Good Quality, reliable terminal/sockets are provided at appropriate places on panel for connections/ observation of waveforms.
- * Strongly supported by detailed Operating Instructions, giving details of Object, Theory, Design procedures, Report Suggestions and Book References.
- * Weight : 3 Kg. (Approx.)
- * Dimension : W 340 x H 110 x D 210

Push Pull Amplifier

Order Code - 36123



Experimental Training Board has been specifically designed for the study of Class B Transistor Push Pull Amplifier.

Practical experience on these boards carries great educative value for Science and Engineering Students.

Object:

To study the class B Transistor Push Pull Amplifier at audio frequencies :

01. To measure output power.
02. To plot the frequency response characteristics.
03. Distortion Measurement.

Features:

The board consists of the following built-in parts :

01. -9V DC at 50mA, IC regulated Power Supply internally connected.
02. Driver Transformer and Output Transformer.
03. Four different output loads selected by a band switch.
04. Three PNP transistors.

Adequate no. of other electronic components.
Mains ON/OFF switch, Fuse and Jewel light.
The unit is operative on 230V \pm 10% at 50Hz A.C. Mains.

Adequate no. of patch cords stackable from rear both ends 4mm spring loaded plug length ½ metre.

Good Quality, reliable terminal/sockets are provided at appropriate places on panel for connections/ observation of waveforms.

Strongly supported by detailed Operating Instructions, giving details of Object, Theory, Design procedures, Report Suggestions and Book References.

Weight : 3 Kg. (Approx.)

Dimension : W 340 x H 110 x D 210

Wien Bridge Audio Oscillator

Order Code - 36124



Experimental Training Board has been designed specifically for the study of Wien Bridge Audio Oscillator. This Training Board helps to understand the utilization of Audio Oscillator and obtain oscillations at different frequencies.

Practical experience on these boards carries great educative value for Science and Engineering Students.

Object:

To study Transistor Wien Bridge Audio Oscillator:

01. To study the main features of the Wien Bridge Audio Oscillator.
02. To obtain oscillation of different frequencies by varying R-C.
03. To study the frequency response of phase shift network.

Features:

The board consists of the following built-in parts :

01. -9V DC at 50mA, IC regulated Power Supply internally connected.

02. Variable gang condenser.
03. Potentiometer.
04. Two PNP transistors.
 - * Adequate no. of other electronic components.
 - * Mains ON/OFF switch, Fuse and Jewel light.
 - * The unit is operative on 230V \pm 10% at 50Hz A.C. Mains.
 - * Adequate no. of patch cords stackable from rear both ends 4mm spring loaded plug length ½ metre.
 - * Good Quality, reliable terminal/sockets are provided at appropriate places on panel for connections/ observation of waveforms.
 - * Strongly supported by detailed Operating Instructions, giving details of Object, Theory, Design procedures, Report Suggestions and Book References.
 - * Weight : 3 Kg. (Approx.)
 - * Dimension : W 340 x H 110 x D 210

Phase Shift Audio Oscillator

Order Code - 36125



Experiment Training Board has been designed specifically for the study of Phase Shift Audio Oscillator. With the help of this Training Board one can understand the utilization of Audio Oscillator and obtain oscillations of different frequencies.

Object:

To study the Phase Shift Audio Oscillator:

01. To study Phase Shift Audio Oscillator circuit using a single transistor.
02. To study the improved Phase Shift Audio Oscillator circuit using two transistors.

Features:

The board consists of the following built-in parts :

01. +9V DC at 50mA, IC regulated Power Supply internally connected.
02. Two transistors.
03. Three sets of three different values of capacitors selected by a switch for varying frequency.
04. Potentiometer for setting gain.
 - * Adequate no. of other electronic components.
 - * Mains ON/OFF switch, Fuse and Jewel light.
 - * The unit is operative on 230V \pm 10% at 50Hz A.C. Mains.
 - * Adequate no. of patch cords stackable from rear both ends 4mm spring loaded plug length ½ metre.
 - * Good Quality, reliable terminal/sockets are provided at appropriate places on panel for connections/ observation of waveforms.
 - * Strongly supported by detailed Operating Instructions, giving details of Object, Theory, Design procedures, Report Suggestions and Book References.
 - * Weight : 3 Kg. (Approx.)
 - * Dimension : W 340 x H 110 x D 210

Amplifier and Oscillator Work Board

Order Code - 36125A



Order Code 36125A Experimental Training Board has been designed specifically for the study of Phase Shift Audio Oscillator & CE amplifier. With the help of this Training Board student can understand the utilization of Audio Oscillator and obtain oscillations of different frequencies with CE amplifier circuit. Practical experience on this board carries great educative value for Science and Engineering Students.

Object:

01. To study the Phase Shift Audio Oscillator circuit.:
02. Study of CE amplifier circuit and to measuring voltage gain. (AV)
03. To plot the frequency response characteristics of the CD amplifier.

Features:

The board consists of the following built-in parts :

01. $\pm 9V$ DC at 50mA, IC regulated Power Supply.
02. Three transistors.
03. Three sets of three different values of capacitors.
04. Potentiometer for setting gain.
05. Adequate no. of other electronic components.
06. Mains ON/OFF switch, Fuse and Jewel light.
07. The unit is operative on 230V $\pm 10\%$ at 50Hz A.C. Mains.
08. Adequate no. of patch cords stackable from rear both ends 4mm spring loaded plug length $\frac{1}{2}$ meter.
09. Good Quality, reliable terminal/sockets are provided at appropriate places on panel for connections/ observation of waveforms.
10. Strongly supported by detailed Operating Instructions, giving details of Object, Theory, Design procedures, Report Suggestions and Book References.

RF (I-C) Oscillators (Hartley's, Colpitt's, Clapp's)

Order Code - 36126



Experiment Training Board has been designed specifically for the study of Transistor RF Oscillators such as (i) Hartley's (ii) Colpitt's and (iii) Clapp's Oscillators using L-C.

Object:

- To study the following transistor RF oscillators using L-C
01. Hartley's Oscillator.
 02. Colpitt's Oscillator.
 03. Clapp's Oscillator.

Features:

The board consists of the following built-in parts :

01. -9V DC at 50mA, IC regulated Power Supply internally connected.

02. PNP transistor.
03. Variable gang condenser.
- * Adequate no. of other electronic components.
- * Mains ON/OFF switch, Fuse and Jewel light.
- * The unit is operative on 230V $\pm 10\%$ at 50Hz A.C. Mains.
- * Adequate no. of patch cords stackable from rear both ends 4mm spring loaded plug length $\frac{1}{2}$ metre.
- * Good Quality, reliable terminal/sockets are provided at appropriate places on panel for connections/ observation of waveforms.
- * Strongly supported by detailed Operating Instructions, giving details of Object, Theory, Design procedures, Report Suggestions and Book References.
- * Weight : 3 Kg. (Approx.)
- * Dimension : W 340 x H 110 x D 210

Free Running Multivibrator (Astable)

Order Code - 36127



Experimental Training Board has been designed specifically for the study of Free Running (Astable) Multivibrator circuit. A free running multivibrator circuit is frequently used as a simple means of generating square wave signal.

Practical experience on these boards carries great educative value for Science and Engineering Students.

Object:

01. To study the operation of a Transistor Free (Astable) Running Multivibrator.
02. To study the waveform at various places on the Free Running Multivibrator Circuit.
03. To study the operation of improved free Running multivibrator and to observe the output wave shape.

Features:

The board consists of the following built-in parts :

01. +9V D.C. at 50mA, IC regulated Power Supply internally connected.
02. Two NPN transistors.
03. Two potentiometers.
- * Adequate no. of other electronic components.
- * Mains ON/OFF switch, Fuse and Jewel light.
- * The unit is operative on 230V $\pm 10\%$ at 50Hz A.C. Mains.
- * Adequate no. of patch cords stackable from rear both ends 4mm spring loaded plug length $\frac{1}{2}$ metre.
- * Good Quality, reliable terminal/sockets are provided at appropriate places on panel for connections/ observation of waveforms.
- * Strongly supported by detailed Operating Instructions, giving details of Object, Theory, Design procedures, Report Suggestions and Book References.

BI-Stable Multivibrator

Order Code - 36128



Experimental Training Board has been designed specifically for the study of Bistable Multivibrator circuit built around transistors. A bistable circuit is widely used in digital circuits.

Practical experience on these boards carries great educative value for Science and Engineering Students.

Object:

01. To study the operation of a Transistor Bistable Multivibrator.
02. To trigger the Bistable Multivibrator with Square wave signal and to compare output frequency with the trigger waveform frequency.

Features:

The board consists of the following built-in parts :

01. +9V D.C. at 50mA, IC regulated Power Supply internally connected.
02. Two NPN transistors.
 - * Adequate no. of other electronic components.
 - * Mains ON/OFF switch, Fuse and Jewel light.
 - * The unit is operative on 230V $\pm 10\%$ at 50Hz A.C. Mains.
 - * Adequate no. of patch cords stackable from rear both ends 4mm spring loaded plug length $\frac{1}{2}$ metre.
 - * Good Quality, reliable terminal/sockets are provided at appropriate places on panel for connections/ observation of waveforms.
 - * Strongly supported by detailed Operating Instructions, giving details of Object, Theory Design procedures, Report Suggestions and Book References.
 - * Weight : 3 Kg. (Approx.)
 - * Dimension : W 340 x H 110 x D210

Mono-Stable Multivibrator

Order Code - 36129



Experimental Training Board has been designed specifically for the study of Monostable Multivibrator circuit which is widely used in digital circuits.

Practical experience on these boards carries great educative value for Science and Engineering Students.

Object:

01. To study the operation of a Transistor Monostable Multivibrator and to produce a pulse train of varying repetition rate from a square wave input.
02. To study the voltage waveforms at various points in the Transistor Monostable Multivibrator circuit.

Features:

The board consists of the following built-in parts :

01. $\pm 9V$ D.C. at 50mA, IC regulated Power Supply

internally connected.

02. Two NPN transistors.
03. One potentiometer.
 - * Adequate no. of other electronic components.
 - * Mains ON/OFF switch, Fuse and Jewel light.
 - * The unit is operative on 230V $\pm 10\%$ at 50Hz A.C. Mains.
 - * Adequate no. of patch cords stackable from rear both ends 4mm spring loaded plug length $\frac{1}{2}$ metre.
 - * Good Quality, reliable terminal/sockets are provided at appropriate places on panel for connections/ observation of waveforms.
 - * Strongly supported by detailed Operating Instructions, giving details of Object, Theory, Design procedures, Report Suggestions and Book References.
 - * Weight : 3 Kg. (Approx.)
 - * Dimension : W 340 x H 110 x D 210

Regulated Power Supplies

Order Code - 36130



Experimental Training Board has been designed specifically for the study of various techniques used for designing transistorised voltage regulated power supplies. A voltage regulated power supply forms an essential part of many electronic equipment.

Practical experience on these boards carries great educative value for Science and Engineering Students.

Object:

01. To study half wave rectification.
02. To study full wave rectification.
03. To study measurement of ripple and ripple reduction methods using the following: (a) Capacitor filter. (b) Inductor filter. (c) Choke input of L.C. filter. (d) CLC or p filter.
04. To study Zener - diode voltage regulator circuit.
05. To study series voltage regulator.
06. To study series regulator with current limiting.
07. To study error feed-back type series voltage regulator.
08. To study the use of Darlington transistor pair for increasing the current capability of series voltage regulator.
09. To study a shunt voltage regulator with current limiting.
10. To study a shunt voltage regulator with adjustable current limiting.
11. To study a 0-9V D.C. continuously variable voltage regulated power supply and measure the following: (A) Line regulation. (B) Load regulation. (C) Ripple factor.

Features:

The board consists of the following built-in parts :

01. 9V A.C. at 300mA, Power Supply.
02. 0-200mA Electronic load.
03. Three NPN and one PNP transistor including a power transistor.
04. 4 diodes, 3 Zener diodes, 2 potentiometers, 1 inductor.

- * Adequate no. of other electronic components.
- * Mains ON/OFF switch, Fuse and Jewel light.
- * The unit is operative on 230V \pm 10% at 50Hz A.C. Mains.
- * Adequate no. of patch cords stackable from rear both ends 4mm spring loaded plug length ½ metre.
- * Good Quality, reliable terminal/sockets are provided at appropriate places on panel for connections/ observation of waveforms.
- * Strongly supported by detailed Operating Instructions, giving details of Object, Theory, Design procedures, Report Suggestions and Book References.
- * Weight : 3 Kg. (Approx.)
- * Dimension : W 340 x H 110 x D 210



36132 Experimental Training Board has been designed specifically for the measurement of inductance of a coil by Anderson Bridge. It includes audio amplifier with speaker for null detection (Instead of head phone) and one KHz sine wave oscillator instead of externally used decade audio frequency generator. The board is absolutely self contained and requires no other apparatus.

Practical experience on these boards carries great educative value for Science and Engineering Students.

Object:

To measure the inductance of a given Coil by Anderson Bridge method.

Features:

The board consists of the following built-in parts :

01. Anderson Bridge circuit with arms values.
 02. Potentiometer for varying one arm.
 03. Three different value inductances.
 04. Potentiometer with calibrated dial.
 05. Five capacitors selected by a band switch.
 06. Audio Amplifier with its IC regulated Power Supply.
 07. One KHz Sine Wave Oscillator with its IC regulated Power Supply.
 08. Speaker.
 09. Mains ON/OFF switch, Fuse and Jewel light.
- * The unit is operative on 230V \pm 10% at 50Hz A.C. Mains.
 - * Adequate no. of patch cords stackable from rear both ends 4/ 2mm spring loaded plug length ½ metre.
 - * Good Quality, reliable terminal/sockets are provided at appropriate places on panel for connections/ observation of waveforms.
 - * Strongly supported by detailed Operating Instructions, giving details of Object, Theory, Design procedures, Report Suggestions and Book References.

Series and Parallel Resonance

Order Code - 36131



Experimental Training Board has been designed specifically for study of Series and Parallel Resonance in LCR Circuits, measurement of Q and dielectric constant of a liquid.

Practical experience on these boards carries great educative value for Science and Engineering Students.

Object:

To study the following :

01. Series resonance for different values of resistances, capacitances, inductances and plotting of resonance curves.
02. Parallel resonance for different values of resistances, capacitances, inductances and plotting of resonance curves.
03. Measurement of Q for both series and parallel resonances.
04. Measurement of dielectric constant relative permittivity of a liquid.

Features:

The board consists of the following built-in parts :

01. Three inductances made on ferrite cores, selectable by a switch.
 02. Three capacitances with low loss factor, selectable by a switch.
 03. Three resistances, selectable by a switch.
- * Adequate no. of patch cords stackable from rear both ends 4/ 2mm spring loaded plug length ½ metre.
 - * Good Quality, reliable terminal/sockets are provided at appropriate places on panel for connections/ observation of waveforms.
 - * Strongly supported by detailed Operating Instructions, giving details of Object, Theory, Design procedures, Report Suggestions and Book References.
 - * Weight : 3 Kg. (Approx.)
 - * Dimension : W 340 x H 110 x D 210

Anderson Bridge

Order Code - 36132

Voltage Multipliers

Order Code - 36133



Experimental Training Board has been designed specifically to study the Voltage Multipliers such as Voltage Doubler, Voltage Tripler and Voltage Quadrupler and to determine their regulation characteristics.

Practical experience on these boards carries great educative value for Science and Engineering Students.

Object:

Study of following Voltage multipliers :

01. Full wave Voltage Doubler.
02. Half wave Voltage Doubler.
03. Voltage Tripler.
04. Voltage Quadrupler.

Features:

The board consists of the following built-in parts :

01. Four diodes.
02. Adequate no. of other electronic components.
- * Adequate no. of patch cords stackable from rear both ends 4mm spring loaded plug length ½ metre.
- * Good Quality, reliable terminal/sockets are provided at appropriate places on panel for connections/ observation of waveforms.
- * Strongly supported by detailed Operating Instructions, giving details of Object, Theory, Design procedures, Report Suggestions and Book References.

Passive Filters (Constant-K, Low, High and Band M-derived Low & High)

Order Code - 36134



Experimental Training Board has been designed specifically to study the various types of Passive Filters and to determine the different constants as well as cut-off frequency of that particular passive filter.

Practical experience on these boards carries great educative value for Science and Engineering Students.

01. Low-Pass constant-K filter.
02. High-Pass constant-K filter.
03. Band-Pass constant-K filter.
04. Low-Pass M-Derived filter.
05. High-Pass M-Derived filter.

Features:

The board consists of the following built-in parts :

01. Different types of Passive Filters.
02. Adequate no. of other electronic components.
- * Adequate no. of patch cords stackable from rear both ends 4mm spring loaded plug length ½ metre.
- * Good Quality, reliable terminal/sockets are provided at appropriate places on panel for connections/ observation of waveforms.
- * Strongly supported by detailed Operating Instructions, giving details of Object, Theory, Design procedures, Report Suggestions and Book References.

Boot Strap Sweep Generator

Order Code - 36135

Experimental Training Board has been designed specifically for the study of Boot Strap Sweep Generator. With the help of this training board, one can study the effect of amplitude, linearity and frequency on Boot Strap Sweep Generator.

Practical experience on these boards carries great educative value for Science and Engineering Students.

Object:

To study Boot Strap Sweep Generator for :

01. Amplitude variation of the output waveform.
02. Frequency variation of the output waveform.

03. Linearity of the output waveform.

Features:

The board consists of the following built-in parts :

01. 0-6V D.C. at 50mA, continuously variable regulated Power Supply.
02. Two PNP transistors.
03. Mains ON/OFF switch, Fuse and Jewel light.
- * The unit is operative on 230V ±10% at 50Hz A.C. Mains.
- * Adequate no. of other electronic components.
- * Adequate no. of patch cords stackable from rear both ends 4mm spring loaded plug length ½ metre.
- * Good Quality, reliable terminal/sockets are provided at appropriate places on panel for connections/observation of waveforms.
- * Strongly supported by detailed Operating Instructions, giving details of Object, Theory, Design procedures, Report Suggestions and Book References.
- * Weight : 3 Kg. (Approx.)
- * Dimension : W 340 x H 110 D 210

Other Apparatus Required:

01. V.T.V.M.
02. Sine Square Wave Oscillator
03. Digital Frequency Counter
04. Cathode Ray Oscilloscope 20MHZ

Puckle's Sweep Generator

Order Code - 36136



Experimental Training Board has been designed specifically for the study of the Puckle's Sweep Generator.

Practical experience on these boards carries great educative value for Science and Engineering Students.

Object:

To study Puckle's Sweep Generator for :

01. Amplitude variation of the output waveform.
02. Frequency variation of the output waveform.
03. Linearity of the output waveform.

Features:

The board consists of the following built-in parts :

01. 9V D.C. at 50mA, IC regulated Power Supply internally connected.
02. Two transistors.
03. Mains ON/OFF switch, Fuse and Jewel light.
- * The unit is operative on 230V ±10% at 50Hz A.C. Mains.
- * Adequate no. of other electronic components.
- * Adequate no. of patch cords stackable from rear both ends 4mm spring loaded plug length ½ metre.
- * Good Quality, reliable terminal/sockets are provided at appropriate places on panel for connections/observation of waveforms.
- * Strongly supported by detailed Operating Instructions, giving details of Object, Theory, Design procedures, Report Suggestions and Book References.

- * Weight : 3 Kg. (Approx.)
- * Dimension : W 340 x H 110 D 210

Other Apparatus Required:

01. V.T.V.M.
02. Digital Frequency Counter
03. Cathode Ray Oscilloscope 20MHz

Phase Splitter

Order Code - 36138

Experimental Training Board has been designed specifically for the study of the Phase Splitter. Practical experience on these boards carries great educative value for Science and Engineering Students.

Object:

Study of Phase Splitter :

01. To see the phase split property of the set-up.
02. To find the Input Impedance.
03. To find the Output Impedance.
04. To draw over load characteristics.

Features:

The board consists of the following built-in parts :

01. -9V D.C. at 50mA, IC regulated Power Supply internally connected.
02. PNP transistor.
03. Potentiometer.
04. Adequate no. of other electronic components.
05. Mains ON/OFF switch, Fuse and Jewel light.
- * The unit is operative on 230V \pm 10% at 50Hz A.C. Mains.
- * Adequate no. of patch cords stackable from rear both ends 4mm spring loaded plug length $\frac{1}{2}$ metre.
- * Good Quality, reliable terminal/sockets are provided at appropriate places on panel for connections/ observation of waveforms.
- * Strongly supported by detailed Operating Instructions, giving details of Object, Theory, Design procedures, Report Suggestions and Book References.
- * Weight : 3 Kg. (Approx.)
- * Dimension : W 340 x H 110 x D 210

Other Apparatus Required:

01. Decade Audio Frequency Generator
02. V.T.V.M.
03. Decade Resistance Box
04. Cathode Ray Oscilloscope 20MHz

Differential Amplifier

Order Code - 36140



Experimental Training Board has been designed specifically for the study of Differential Amplifier in solid state version. A Differential Amplifier is also called a Differential Amplifier and it is essential part of operational amplifier. As operational amplifiers are now a days being used quite extensively in instrumentation control and entertainment electronics, this Training Board has great educational value. Practical experience on these boards carries great

educative value for Science and Engineering Students.

Object:

01. To study the operation of a Differential Amplifier.
02. To measure the Common Mode Gain and Differential Mode Gain of the Differential Amplifier and determine its Common Mode Rejection Ratio(CMRR).

Features:

The board consists of the following built-in parts:

01. \pm 9VD.C. at 100mA, IC regulated Power Supply internally connected.
02. Three NPN transistors.
03. Adequate no. of other electronic components.
04. Mains ON/OFF switch, Fuse and Jewel light.
- * The unit is operative on 230V \pm 10% at 50Hz A.C. Mains.
- * Adequate no. of patch cords stackable from rear both ends 4mm spring loaded plug length $\frac{1}{2}$ metre.
- * Good Quality, reliable terminal/sockets are provided at appropriate places on panel for connections/ observation of waveforms.
- * Strongly supported by detailed Operating Instructions, giving details of Object, Theory, Design procedures, Report Suggestions and Book References.

Other Apparatus Required:

01. Audio Frequency Generator
02. A.C. Millivoltmeter
03. Cathode Ray Oscilloscope 20MHz

Diode Limiters

Order Code - 36141



Experimental Training Board has been designed specifically for the study of Diode Limiter circuits. Practical experience on these boards carries great educative value for Science and Engineering Students.

Object:

Study of Diode Limiter Circuits:

01. To draw the transmission characteristics of the different Diode Limiter configurations.
02. To observe the limiting action of the sine wave on the Oscilloscope.
03. To observe the effect of diode capacitance at very high frequencies.

Features:

The board consists of the following built-in parts :

01. Four Diodes.
02. 1.5V Battery.
- * Adequate no. of other electronic components.
- * Adequate no. of patch cords stackable from rear both ends 4mm spring loaded plug length $\frac{1}{2}$ metre.
- * Good Quality, reliable terminal/sockets are provided at appropriate places on panel for connections/ observation of waveforms.
- * Strongly supported by detailed Operating Instructions, giving details of Object, Theory, Design procedures, Report Suggestions and Book References.

Other Apparatus Required:

- * Decade Audio Frequency Generator
- * IC Regulated Power Supply
- * Cathode Ray Oscilloscope 20MHz

F.E.T. Amplifier

Order Code - 36142



Experimental Training Board has been designed specifically for the study of FET Amplifier. Practical experience on these boards carries great educative value for Science and Engineering Students.

Object:

Study of FET Amplifier :

01. To design and calculate the finite gain of FET Amplifier.
02. To draw the overload characteristics.
03. To draw the frequency response.
04. To measure the input impedance.
05. To measure the output impedance.

Features:

The board consists of the following built-in parts :

01. +15V D.C. at 50mA, IC regulated Power Supply internally connected.
02. Field Effect Transistor.
03. Mains ON/OFF switch, Fuse and Jewel light.
- * The unit is operative on 230V \pm 10% at 50Hz A.C. Mains.
- * Adequate no. of other electronic components.
- * Adequate no. of patch cords stackable from rear both ends 4mm spring loaded plug length ½ metre.
- * Good Quality, reliable terminal/sockets are provided at appropriate places on panel for connections/ observation of waveforms.
- * Strongly supported by detailed Operating Instructions, giving details of Object, Theory, Design procedures, Report Suggestions and Book References.
- * Weight : 3 Kg. (Approx.)
- * Dimension : W 340 x H 110 x D 210

Other Apparatus Required:

01. Audio Frequency Generator
02. A.C. Millivoltmeter
03. Decade Resistance Box
04. Cathode Ray Oscilloscope 20MHz

Schmitt's Trigger

Order Code - 36143



Experimental Training Board has been designed specifically for the study of Schmitt's transistor binary circuit. Study of this circuit is useful for digital electronics. Practical experience on these boards carries great educative value for Science and Engineering Students.

Object:

Study of schmitt's transistor Binary circuit :

01. To find loop gain of the binary circuit and to see the parameters responsible for making the loop gain to 1.
02. To adjust the loop gain to be less than 1 and to see linear amplification.
03. To adjust the loop gain to be slightly greater than 1 and to observe the switching action.

Features:

The board consists of the following built-in parts :

01. 0-12V DC at 50mA, continuously variable regulated Power Supply internally connected.
02. Two PNP transistors.
03. Adequate no. of other electronic components.
04. Mains ON/OFF switch, Fuse and Jewel light.
- * The unit is operative on 230V \pm 10% at 50Hz A.C. Mains.
- * Adequate no. of patch cords stackable from rear both ends 4mm spring loaded plug length ½ metre.
- * Good Quality, reliable terminal/sockets are provided at appropriate places on panel for connections/ observation of waveforms.
- * Strongly supported by detailed Operating Instructions, giving details of Object, Theory, Design procedures, Report Suggestions and Book References.

Two Stage R-C Coupled Transistor Amplifier

Order Code - 36146



Experimental Training Board has been designed specifically for the study of Two Stage R-C Coupled Transistor Amplifier.

Practical experience on these boards carries great educative value for Science and Engineering Students.

Object:

Study of the characteristics of Two Stage R-C Coupled Transistor Amplifier :

01. Study of the overload characteristics of the amplifier.
02. Study of the frequency response of the individual as well as the cascade amplifier.
03. Calculate the output and input impedance of the individual stages as well as that of cascade amplifier.

Features:

The board consists of the following built in parts :

01. -12V D.C. IC regulated Power Supply internally connected.
02. Two PNP transistors.
03. Adequate no. of other electronic components.
04. Mains ON/OFF switch, Fuse and Jewel light.
- * The unit is operative on 230V \pm 10% at 50Hz A.C. Mains.
- * Adequate no. of patch cords stackable from rear both ends 4mm spring loaded plug length ½ metre.
- * Good Quality, reliable terminal/sockets are

provided at appropriate places on panel for connections/ observation of waveforms.

- * Strongly supported by detailed Operating Instructions, giving details of Object, Theory, Design procedures, Report Suggestions and Book References.

Schmitt's F.E.T. Binary

Order Code - 36147



Experimental Training Board has been designed specifically for the study of Schmitt's FET Binary Circuit. Study of this circuit is very useful for digital electronics. Practical experience on these boards carries great educative value for Science and Engineering Students.

Object:

To study the Schmitt's FET Binary circuit :

01. To find out the loop gain of the binary circuit and study the output waveform for different amplitudes of audio signal.
02. To study the supply voltage change on the output waveform.
03. To study the effect of the frequency variation on the output waveform.

Features:

The board consists of the following built-in parts :

01. 0-9V D.C. at 50mA, continuously variable regulated Power Supply.
 02. Two Field Effect Transistors.
 03. Adequate no. of other electronic components.
 04. Mains ON/OFF switch, Fuse and Jewel light.
- * The unit is operative on 230V \pm 10% at 50Hz A.C. Mains.
 - * Adequate no. of patch cords stackable from rear both ends 4mm spring loaded plug length 1/2 metre.
 - * Good Quality, reliable terminal/sockets are provided at appropriate places on panel for connections/ observation of waveforms.
 - * Strongly supported by detailed Operating Instructions, giving details of Object, Theory, Design procedures, Report Suggestions and Book References.

Other Apparatus Required:

01. Decade Audio Frequency Generator
02. Cathode Ray Oscilloscope 20MHz

Diode & Zener Diode Characteristics

Order Code - 36152



Experimental Training Board has been designed specifically for plotting the forward and reverse bias characteristics of a Germanium semiconductor Diode, and a Zener Diode. The board is absolutely self contained and requires no other apparatus. Practical experience on this board carries great

educative value for Science and Engineering Students.

Object:

01. To study and plot the forward & reverse bias characteristics of a Germanium semiconductor Diode.
02. To study and plot the forward & reverse bias (breakdown) characteristics of a Zener Diode.

Features:

The board consists of the following built-in parts :

01. 0-10V D.C. at 10mA, continuously variable regulated Power Supply with low ripple & hum and integral current limiting resistor.
 02. Digital Voltmeter DC 3 1/2 Digit Having Dual range of 2V/ 20V.
 03. Digital Current meter DC 3 1/2 Digit Having Dual range of 20mA/ 20mA
 04. A Germanium semiconductor Diode mounted behind the panel.
 05. A Zener Diode mounted behind the panel.
 06. Adequate no. of other electronic components.
 07. Mains ON/OFF switch, Fuse and Jewel light.
- * The unit is operative on 230V \pm 10% at 50Hz A.C. Mains.
 - * Adequate no. of patch cords stackable from rear both ends 4mm spring loaded plug length 1/2 metre.
 - * Good Quality, reliable terminal/sockets are provided at appropriate places on panel for connections / observation of waveforms.
 - * Strongly supported by detailed Operating Instructions, giving details of Object, Theory, Design procedures, Report Suggestions and Book References.

Diode Characteristic Curve Apparatus

Order Code - 36152A



Experimental Training Board has been designed specifically for plotting Characteristics of Ge & Si Semiconductor Diodes. The board is absolutely self contained and requires no other apparatus. Practical experience on this board carries great educative value for Science and Engineering Students.

Object:

01. To Study and Plot the Forward and Reverse Bias characteristics of (Si) Semiconductor Diodes.
02. To Determine the Static and Dynamic resistances of Forward Biased p-n junction of the given Diodes.

Features:

The board consists of following built-in parts:

01. 0-10V D.C. at 50mA, continuously variable with Coarse & Fine Pots, regulated Power Supply.
02. Si Semiconductor Diodes.
03. Adequate no. of other electronic components.
04. Mains ON/OFF switch and Fuse.
05. The unit is operative on 230V \pm 10% at 50Hz A.C. Mains.
06. Adequate no. of patch cords 4mm length 50cm
07. Good Quality, reliable terminal/sockets are provided at appropriate places on panel for

connections/observation of waveforms.

- * Strongly supported by detailed Operating Instructions, giving details of Object, Theory, Design procedures, Report Suggestions and Book References.

Transistor Characteristics

Order Code - 36153



Experimental Training Board has been designed specifically to study the Transistor input and output Characteristics in different modes i.e. Common Base, Common Emitter and Common Collector. This Training Board is an improved version with Germanium NPN & PNP transistors in addition to Silicon NPN & PNP transistors and four meters. The board is absolutely self contained and requires no other apparatus.

Practical experience on this board carries great educative value for Science and Engineering Students.

Object:

To study and plot the Transistor input and output Characteristics in the following configurations :

01. Common Emitter Mode.
02. Common Base Mode.
03. Common Collector Mode.
04. Transfer Characteristics of Transistor

Features:

The board consists of the following built-in parts :

01. Two 0-10V DC at 50mA, continuously variable Power Supplies for Base Emitter & Collector Emitter junctions.
02. Two Digital Voltmeter DC 3½ Digit having Dual range of 2V / 20V.
03. Two Digital Current meter DC 3½ Digit having Dual range of 200mA / 20mA
04. Two silicon (NPN & PNP) transistors and two Germanium (NPN & PNP) transistors.
05. Adequate No. of other electronic components.
06. Mains ON/OFF switch, Fuse and Jewel light.
- * The unit is operative on 230V ±10% at 50Hz A.C. Mains.
- * Adequate no. of patch cords stackable from rear both ends 4mm spring loaded plug, length ½ metre.
- * Good Quality, reliable terminal/sockets are provided at appropriate places on panel for connections /observation of waveforms.
- * Strongly supported by detailed Operating Instructions, giving details of Object, Theory, Design procedures, Report Suggestions and Book References.

F.E.T. Characteristics

Order Code - 36154



Experimental Training Board has been designed

specifically to study the characteristics of a Field Effect Transistor. The board is absolutely self contained and requires no other apparatus.

Practical experience on this board carries great educative value for Science and Engineering Students.

Object:

To study the characteristics of Field Effect Transistor.

01. Measurement of I_{DSS}
02. Plot the static drain characteristics of FET
 - 2.1 Drain Current V_s Drain Voltage Characteristics for different fixed values of V_{GS}
 - 2.2 Drain Current V_s Gate Bias Characteristics for different fixed values of V_{DS}
03. Show that FET work as VVR (voltage variable resistance).
04. Calculate the FET parameters (drain dynamic resistance r_d , mutual conductance g_m , and amplification factor m) at a given operating point.

Features

The Board consists of the following built-in parts:

01. 0 to 20V D.C. at 50mA, continuously variable Power Supply.
02. 0 to 12V D.C. at 50mA, continuously variable Power Supply.
03. Two Digital Voltmeter DC 3½ Digit having range of 0- 20V.
04. Digital Current meter DC 3½ Digit having range of 0- 20mA
05. One Field Effect Transistor.
06. Adequate no. of other electronic components.
07. Mains ON/OFF switch, Fuse and Jewel light.
08. The unit is operative on 230V ±10% at 50Hz A.C. Mains.
09. Adequate no. of patch cords 4mm length 50cm.
- * Good Quality, reliable terminal/sockets are provided at appropriate places on panel for connections /observation of waveforms.
- * Strongly supported by detailed Operating Instructions, giving details of Object, Theory, Design procedures, Report Suggestions and Book References.
- * Weight : 3 Kg. (Approx.)
- * Dimension : W 340 x H 110 x D 210

Integrating Differentiating and Clamping Circuits

Order Code - 36155



Experimental Training Board has been designed specifically to study the Integrating, Differentiating and Clamping Circuits.

Practical experience on this board carries great educative value for Science and Engineering Students.

Object:

01. Study of Integrating Circuit response at 1KHz and 10 KHz for different combinations of R and C.
02. Study of Differentiating Circuit response at 1 KHz and 10 KHz for different combinations of R and C.
03. Study of series and shunt Clamping Circuits.

Features:

The board consists of the following built-in parts:

01. 0-10V D.C. at 20mA, continuously variable Power Supply.
 02. Square Wave Generator with switch selectable frequency ranges of 1KHz and 10KHz.
 03. Diode.
 04. Rotary switch for selection of different values of capacitors.
 05. Adequate no. of other electronic components.
 06. Mains ON/OFF switch, Fuse and Jewel light.
- * The unit is operative on 230V \pm 10% at 50Hz A.C. Mains.
 - * Adequate no. of patch cords stackable from rear both ends 4mm spring loaded plug length ½ metre.
 - * Good Quality, reliable terminal/sockets are provided at appropriate places on panel for connections / observation of waveforms.
 - * Strongly supported by detailed Operating Instructions, giving details of Object, Theory, Design procedures, Report Suggestions and Book References.

Silicon Controlled Rectifier Characteristics

Order Code - 36156



Experimental Training Board has been designed specifically to study the Silicon Controlled Rectifier phase firing and D.C. Control characteristics. It is a training aid for advance studies in control circuits. Practical experience on this board carries great educative value for Science and Engineering Students.

Object:

1. To study the D.C. gate control characteristics (firing characteristics) of a SCR.
2. To study and plot the anode current characteristics of a SCR.
3. To measure the holding current of a SCR.
4. To study the plot the phase firing characteristics of a SCR.

Features:

The Board consists of the following built-in parts:

01. 0 to 50V DC at 50mA, continuously variable Power Supply for Anode.
 02. 0 to 3V DC at 50mA, continuously variable Power Supply for Gate.
 03. 0-10VAC at 50Hz, variable Power Supply for Anode.
 04. Digital Voltmeter DC 3½ Digit having Dual range of 20V/200V.
 05. Digital Current meter DC 3½ Digit having range of 0-200mA.
 06. Silicon Controlled Rectifier.
 07. Fixed limiting resistances.
 08. Adequate no. of other electronic components.
 09. Mains ON/OFF switch, Fuse and Jewel light.
- * The unit is operative on 230V \pm 10% at 50Hz A.C. Mains.
 - * Adequate no. of patch cords 4mm length 50cm.
 - * Good Quality, reliable terminal/sockets are

provided at appropriate places on panel for connections / observation of waveforms.

- * Strongly supported by detailed Operating Instructions, giving details of Object, Theory, Design procedures, Report Suggestions and Book References.

Transistor Feed Back Amplifier

Order Code - 36157

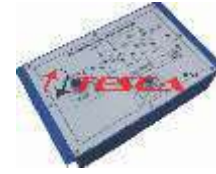

Experimental Training Board has been designed specifically for the study of Transistor Feedback Amplifier.

Practical experience on this board carries great educative value for Science and Engineering Students.

Object:

01. To observe the gain of the amplifier at 1 KHz with and without negative feed back in the emitter circuit and external feed back network disconnected.
02. To observe the variation of the gain of the amplifier with different amount of feed back in the external circuit at 1 KHz.
03. To measure the input and output impedances of the feed back amplifier.
04. To observe the overload characteristics.

Features:

The board consists of the following built-in parts :

01. +9V D.C. at 100mA, IC Regulated Power Supply internally connected.
 02. Two stage transistor amplifier.
 03. 1 KHz fixed solid state sine wave oscillator with 0-1V output amplitude control.
 04. Feed Back network consisting of ten resistances, each selected by a band switch and a fixed feed back capacitor.
 05. Adequate no. of other electronic components.
 06. Mains ON/OFF switch, Fuse and Jewel light.
- * The unit is operative on 230V \pm 10% at 50Hz A.C. Mains.
 - * Adequate no. of patch cords stackable from rear both ends 4mm spring loaded plug length ½ metre.
 - * Good Quality, reliable terminal/sockets are provided at appropriate places on panel for connections / observation of waveforms.
 - * Strongly supported by detailed Operating Instructions, giving details of Object, Theory, Design procedures, Report Suggestions and Book References.

Determination of Energy Band Gap In Semiconductor Diode

Order Code - 36159



Experimental Training Board has been designed specifically for Determination of Energy Band Gap in

Semiconductor (P-N Junction Diode) using Temperature dependent of reverse saturation current. The board is absolutely self contained and requires no other apparatus. Practical experience on this board carries great educative value for Science and Engineering Students.

Object:

01. To draw the characteristics of a P-N junction Diode for reverse saturation current and temperature.
02. To determine the Energy Band Gap in a P-N Junction Diode.

Features:

The board consists of the following built-in parts :

01. 2V D.C. at 10mA, regulated Power Supply.
 02. Digital Microammeter, 3½ digits having range 200uA D.C.
 03. Semiconductor Diode.
 04. Thermometer 0-110 °C.
 05. Oven, Electrically heated to heat the Semiconductor Diode.
 06. Mains ON/OFF switch and Fuse.
- * The unit is operative on 230V ±10% at 50Hz A.C. Mains.
 - * Adequate no. of patch cords stackable from rear both ends 4mm spring loaded plug length ½ metre.
 - * Good Quality, reliable terminal/sockets are provided at appropriate places on panel for connections/observation of waveforms.
 - * Strongly supported by detailed Operating Instructions, giving details of Object, Theory, Design procedures, Report Suggestions and Book References.

Thermistor Characteristics

Order Code - 36160



Experimental Training Board has been designed specifically to study the Characteristics of a Thermistor. The board is absolutely self contained and requires no other apparatus. Practical experience on this board carries great educative value for Science and Engineering Students.

Object:

01. To draw Resistance V/s Temperature characteristics of a Thermistor.
02. To find temperature co-efficient of thermistor from graph and to verify it by comparing with theoretical value.

Features:

The board consists of the following built-in parts :

01. 1V, 2V and 5V D.C. at 10mA, Power Supply selectable by band switch.
02. Digital Milliammeter 3½ digits having range 2mA D.C.
03. Oven, Electrically heated, for the purpose of varying the temperature of the thermistor.
04. Thermistor with leads.
05. Thermometer 0-110 °C.
06. Mains ON/OFF switch and Fuse.

- * The unit is operative on 230V ±10% at 50Hz A.C. Mains.
- * Strongly supported by detailed Operating Instructions, giving details of Object, Theory, Design procedures, Report Suggestions and Book References.
- * Weight : 3 Kg. (Approx.)
- * Dimension : W 340 x H 110 x D 210

Thermistor Characteristics

Order Code - 36161



Experimental Training Board has been designed specifically to study the Transistor Bias Stability. Practical experience on this board carries great educative value for Science and Engineering Students.

Object:

01. To study the leakage current variation with temperature.
02. To see the shift in Q point at different operating temperatures.
03. To see the effect of temperature on stability of an amplifier.
04. To see the distortion in a single stage amplifier as a result of change in Q point.

Features:

The board consists of the following built-in parts :

01. -12V D.C. at 20mA, regulated Power Supply internally connected.
 02. Oscillator, 1KHz fixed frequency with amplitude control.
 03. D.C. Voltmeter, 65mm rectangular dial to read 0-15V.
 04. D.C. Microammeter, 65mm rectangular dial to read with switch selectable ranges of 500mA and 10mA.
 05. Oven, Electrically heated, to change temperature of the transistor.
 06. PNP transistor.
 07. Thermometer 0-110 °C.
 08. Adequate no. of other electronic components.
 09. Mains ON/OFF switch, Fuse and Jewel light.
- * The unit is operative on 230V ±10% at 50Hz A.C. Mains.
 - * Adequate no. of patch cords stackable from rear both ends 4mm spring loaded plug length ½ metre.
 - * Good Quality, reliable terminal/sockets are provided at appropriate places on panel for connections / observation of waveforms.
 - * Strongly supported by detailed Operating Instructions, giving details of Object, Theory, Design procedures, Report Suggestions and Book References.

Sequential Timer

Order Code - 36164



Verification of Laws & Network Theorems in DC Circuits

Order Code - 36165



Experimental Training Board has been designed specifically for the study & verification of the laws and network theorems in D.C. circuits. The board is absolutely self contained and requires no other apparatus.

Practical experience on this board carries great educative value for Science and Engineering Students.

Object:

01. Verification of Ohm's Law.
02. To draw the V-I characteristics for studying the D.C. behavior of the following :
 - (a) Ideal resistance.
 - (b) Semiconductor diode.
 - (c) Zener diode.
 - (d) Thermistor (NTC Type).
03. To verify Kirchoff's current law and voltage law.
04. Verification of the series & parallel laws for resistances.
05. Verification of Superposition Theorem.
06. Study of potential divider.
07. Verification of Maximum Power Transfer Theorem.
08. To verify Thevenin's Theorem and to find equivalent voltage source circuit.
09. To verify Norton's Theorem and to find equivalent current source circuit.
10. To study the design of a multimeter.

Features:

The board consists of following built-in parts:

01. 0-30V D.C. at 100 mA, continuously variable IC Regulated Power Supply.
02. +9V D.C. at 100 mA, IC Regulated Power Supply.
03. +5V D.C. at 100 mA, IC Regulated Power Supply.
04. D.C. Voltmeter, 65mm rectangular dial with switch selectable ranges of 0.5, 1.5, 25 & 50V.
05. D.C. Ammeter, 65mm rectangular dial with switch selectable ranges of 0.05, 0.5, 5, 50 & 100mA.
06. Adequate no. of other electronic components.
 - * The unit is operative on 230V \pm 10% at 50Hz A.C. Mains.
 - * Adequate no. of patch cords stackable from rear both ends 4mm spring loaded plug length 1/2 metre.
 - * Good Quality, reliable terminal/sockets are provided at appropriate places on panel for connections / observation of waveforms.
 - * Strongly supported by detailed Operating Instructions, giving details of Object, Theory, Design procedures, Report Suggestions and Book References.

Triac Characteristics

Order Code - 36166



Experimental Training Board has been designed specifically to study the characteristics of TRIAC-a Bidirectional Triode Thyristor.

Practical experience on this board carries great educative value for Science and Engineering Students.

Object:

1. To study the gate characteristics of a TRIAC in the following modes :
 - (a) Mode I+ : i.e. T2 positive with respect to T1 and gate positive with respect to T 1
 - (b) Mode I- : i.e. T2 positive with respect to T1 and gate negative with respect to T 1
 - (c) Mode III+ : i.e. T2 negative with respect to T1 and gate positive with respect to T 1
 - (d) Mode III- : i.e. T2 negative with respect to T1 and gate negative with respect to T 1
2. To study the terminal characteristics of a TRIAC in the following modes :
 - (a) Mode I+ : i.e. T2 positive with respect to T1 and gate positive with respect to T 1
 - (b) Mode III+ : i.e. T2 negative with respect to T1 and gate positive with respect to T 1
3. To study the following applications of TRIAC :
 - (a) Triac as a static switch (D.C. control).
 - (b) Control of A.C. with A.C. signal.
 - (c) To measure the holding current of IH. Triac.

Features

The board consists of following built-in parts:

01. 0-70V D.C. at 100mA, regulated Power Supply.
02. 0-3V D.C. at 30 mA, regulated Power Supply.
03. 55 Volt at 100mA, fixed A.C. Supply.
04. 7 Volt at 30mA, fixed A.C. Supply.
05. Digital Current meter DC 3 1/2 Digit having Dual range of 20mA / 200mA .
06. Digital Voltmeter DC 3 1/2 Digit having Dual range of 2V / 200V.
07. Digital Current meter DC 3 1/2 Digit range of 200mA.
08. TRIAC.
09. Three Potentiometers of 100K, 10K and 220 Ohm.
10. Reset switch.
11. Adequate no. of other electronic components.
12. Mains ON/OFF switch, Fuse and Jewel light.
 - * The unit is operative on 230V \pm 10% at 50Hz A.C. Mains.
 - * Adequate no. of patch cords stackable from rear both ends 4mm spring loaded plug length 1/2 metre.
 - * Good Quality, reliable terminal/sockets are provided at appropriate places on panel for connections / observation of waveforms.
 - * Strongly supported by detailed Operating Instructions, giving details of Object, Theory, Design procedures, Report Suggestions and Book References.

Diac Characteristics

Order Code - 36167



Experimental Training Board has been designed specifically to study the characteristics and applications of a DIAC. DIAC is extensively used now a days in power control circuits.

Practical experience on this board carries great educative value for Science and Engineering Students.

Object:

01. To plot V-I Characteristics of a DIAC and study the following :
 - 1.1 Breakover voltage, VBO.
 - 1.2 Negative resistance region.
 - 1.3 VBO symmetry and delta V
02. To study the applications of a DIAC as :
 - 2.1 Saw tooth waveform generator.
 - 2.2 Pulse train generator.

Features:

The board consists of following built-in parts:

01. 0-50V D.C. at 50mA, regulated Power Supply.
 02. 45V A.C. at 50mA, unregulated Power Supply.
 03. D.C. Voltmeter, 65mm rectangular dial to read 0-50V D.C.
 04. D.C. Ammeter, 65mm rectangular dial with switch selectable ranges of 200mA and 50mA.
 05. DIAC.
 06. Potentiometer and adequate no. of other electronic components.
 07. Mains ON/OFF switch, Fuse and Jewel light.
- * The unit is operative on 230V \pm 10% at 50Hz A.C. Mains.
 - * Adequate no. of patch cords stackable from rear both ends 4mm spring loaded plug length 1/2 metre.
 - * Good Quality, reliable terminal/sockets are provided at appropriate places on panel for connections /observation of waveforms.
 - * Strongly supported by detailed Operating Instructions, giving details of Object, Theory, Design procedures, Report Suggestions and Book References.

DE-Sauty Bridge

Order Code - 36168



Experimental Training Board has been designed specifically to study De-Sauty Bridge and to compare the capacitance of two capacitors.

Practical experience on this board carries great educative value for Science and Engineering Students.

Object:

To study the working of a De-Sauty Bridge and to compare the capacitance of two capacitors.

Features:

The board consists of following built-in parts:

01. Two Decade Resistances, each with single dial in steps of 100W total 1kW, to form the two arms of the bridge.
 02. Two Decade Capacitors, each with single dial in steps of 0.1mF total 1mF, to form the other two arms of the bridge.
 03. A High Impedance Head Phone, for detecting the null position.
- * Adequate no. of patch cords stackable from rear both ends 4mm spring loaded plug length 1/2 metre.

- * Strongly supported by detailed Operating Instructions, giving details of Object, Theory, Design procedures, Report Suggestions and Book References.

- * Weight : 3 Kg. (Approx.)

- * Dimension : W 340 x H 110 x D 210

Semiconductor Diode Characteristics

Order Code - 36169



Experimental Training Board has been designed specifically for plotting Characteristics of Ge & Si Semiconductor Diodes. The board is absolutely self contained and requires no other apparatus.

Practical experience on this board carries great educative value for Science and Engineering Students.

Object:

01. To Study and Plot the Forward and Reverse Bias characteristics of (Ge & Si) Semiconductor Diodes.
02. To Determine the Static and Dynamic resistances of Forward Biased p-n junction of the given Diodes.

Features:

The board consists of following built-in parts:

1. 0-10V D.C. at 50mA, continuously variable with Coarse & Fine Pots, regulated Power Supply.
 2. Digital Voltmeter DC 3 1/2 Digit Having Dual range of 2V / 20V.
 3. Digital Current meter DC 3 1/2 Digit Having Dual range of 20mA / 20mA
 4. Ge and Si Semiconductor Diodes.
 5. Adequate no. of other electronic components.
 6. Mains ON/OFF switch and Fuse.
- * The unit is operative on 230V \pm 10% at 50Hz A.C. Mains.
 - * Adequate no. of patch cords 4mm length 50cm
 - * Good Quality, reliable terminal/sockets are provided at appropriate places on panel for connections /observation of waveforms.
 - * Strongly supported by detailed Operating Instructions, giving details of Object, Theory, Design procedures, Report Suggestions and Book References.

PN Junction / Semiconductor Diode Characteristic Apparatus

Order Code - 36169A



Order Code - 36169A Experimental Training Board has been designed specifically for plotting the forward and reverse bias characteristics of a Silicon semiconductor Diode, and a Zener Diode. The board is absolutely self contained and requires no other apparatus.

Practical experience on this board carries great educative value for Science and Engineering Students.

Object:

01. To study and plot the forward & reverse bias

characteristics of a Silicon semiconductor Diode.

- To study and plot the forward & reverse bias (breakdown) characteristics of a Zener Diode.

Features:

The board consists of the following built-in parts :

- 0-10V D.C. at 10mA, continuously variable regulated Power Supply with low ripple & hum and integral current limiting resistor.
 - A Silicon semiconductor Diode mounted behind the panel.
 - A Zener Diode mounted behind the panel.
 - Adequate no. of other electronic components.
 - Mains ON/OFF switch, Fuse and Jewel light.
- * The unit is operative on 230V \pm 10% at 50Hz A.C. Mains.
 - * Adequate no. of patch cords stackable from rear both ends 4mm spring loaded plug length 1/2 metre.
 - * Good Quality, reliable terminal/sockets are provided at appropriate places on panel for connections/observation of waveforms.
 - * Strongly supported by detailed Operating Instructions, giving details of Object, Theory, Design procedures, Report Suggestions and Book References.

Function Generator (Using IC-566)

Order Code - 36170



Experimental Training Board has been designed specifically to understand the operation of function generator chip. In digital circuits the operation of various gates, flip-flops etc. are dependent on the control signals. Various methods are employed in generating these train of pulses. With the advancement in the semiconductor technology various types of ICs have come in the market which provide Sine, Triangle, Ramp, Square etc. wave outputs. Here we will discuss the use of function generator IC to generate square and triangle wave outputs.

Practical experience on this board carries great educative value for Science and Engineering Students.

Object:

To study the operation of a function generator.

Features:

The board consists of the following built-in parts :

- +12V D.C. at 100mA, IC Regulated Power Supply.
 - \pm 6V D.C. at 100mA, IC Regulated Power Supply.
 - Function Generator chip (566) mounted on a I.C. base.
 - Control voltage is set with the help of band switches and potentiometer.
 - LED for visual indication of output waveform (TTL output).
 - Adequate no. of other electronic components.
 - Mains ON/OFF switch, Fuse and Jewel light.
- * The unit is operative on 230V \pm 10% at 50Hz A.C. Mains.
 - * Adequate no. of patch cords stackable from rear both ends 4mm spring loaded plug length 1/2

metre.

- * Good Quality, reliable terminal/sockets are provided at appropriate places on panel for connections / observation of waveforms.
- * Strongly supported by detailed Operating Instructions, giving details of Object, Theory, Design procedures, Report Suggestions and Book References.

Other Apparatus Required:

- Digital Multimeter 3 3/4 digit
- Cathode Ray Oscilloscope 20MH
- Digital Frequency Counter

Two Stage Transformer Coupled Amplifier

Order Code - 36171



Experimental Training Board has been designed specifically for the study of Two Stage Transformer Coupled Amplifier. With the help of this Training Board one can know about the different aspects and need for such as two stage transformer coupled transistor amplifier and its characteristics and also compare with that of two stage R.C. Coupled amplifier.

Practical experience on this board carries great educative value for Science and Engineering Students.

Object:

To study the performance characteristics of a Two Stage Transformer Coupled Amplifier :

- To plot frequency response characteristics.
- To find the lower & upper cut-off frequency & find out the band-width of the amplifier.
- To compare the frequency response characteristics of two stage transformer coupled amplifier with that of two stage R.C. Coupled amplifier

Features:

The board consists of the following built-in parts :

- 12V D.C. at 50mA, IC Regulated Power Supply internally connected.
 - Two transistors.
 - Set of Audio Transformer.
 - Adequate no. of other Electronic Components.
 - Mains ON/OFF switch, Fuse and Jewel light.
- * The unit is operative on 230V \pm 10% at 50Hz A.C. Mains.
 - * Adequate no. of patch cords stackable from rear both ends 4mm spring loaded plug length 1/2 metre.
 - * Good Quality, reliable terminal/sockets are provided at appropriate places on panel for connections / observation of waveforms.
 - * Strongly supported by detailed Operating Instructions, giving details of Object, Theory, Design procedures, Report Suggestions and Book References.

Study Of Operational Amplifier (741)

Order Code - 36172



Experimental Training Board has been designed specifically for the study of Operational Amplifier (mA 741) . This training Board gives students an idea of Analogue Computation. Practical experience on this board carries great educative value for Science and Engineering Students.

Object:

To study the following applications of Operational Amplifier (mA 741) :

01. Study of OP-AMP 741 as Integrator and Summing Amplifier.
02. Study of OP-AMP 741 as Differentiator.
03. Study of OP-AMP 741 as Scalar and Summer.
04. Study of OP-AMP 741 as Oscillator.
05. Study of OP-AMP 741 as Differential Input Amplifier.
06. Study of OP-AMP 741 as Voltage Follower.

Features:

The board consists of the following built-in parts :

01. $\pm 12V$ DC at 50mA, IC regulated Power Supply internally connected.
02. OP-AMP IC 741.
03. Dual Potentiometer.
04. Adequate no. of other electronic components.
05. Mains ON/OFF switch, Fuse and Jewel light.
- * The unit is operative on 230V $\pm 10\%$ at 50Hz A.C. Mains.
- * Adequate no. of patch cords stackable from rear both ends 4mm spring loaded plug length $\frac{1}{2}$ metre.
- * Good quality, reliable terminal/sockets are provided at appropriate places on panel for connections/ observation of waveforms.
- * Strongly supported by detailed Operating Instructions, giving details of Object, Theory, Design procedures, Report Suggestions and Book References.

Other Apparatus Required:

01. IC Regulated Power Supply
02. Decade Audio Frequency Generator
03. Sine Square Wave Generator
04. Cathode Ray Oscilloscope 20MHz

Wide Band Amplifier

Order Code - 36173

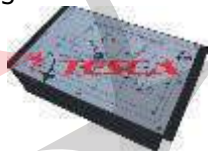

Experimental Training Board has been designed specifically to study the characteristics of Wide Band Amplifier in terms of Frequency Response and Gain. Practical experience on this board carries great educative value for Science and Engineering Students.

Object:

01. To study the Wide Band Amplifier with and without Feedback.
02. To draw the frequency response of the Amplifier.
03. To obtain the input and output Impedance of the Amplifier Stage.

Features:

The board consists of the following built-in parts :

01. +24V DC at 50mA, IC regulated Power Supply internally connected.
02. Two Transistors.
03. SPST switch for selecting and deselecting the feedback network.
04. Potentiometer and adequate no. of other electronic components.
05. Mains ON/OFF switch, Fuse and Jewel light.
- * The unit is operative on 230V $\pm 10\%$ at 50Hz A.C. Mains.
- * Adequate no. of patch cords stackable from rear both ends 4mm spring loaded plug length $\frac{1}{2}$ metre.
- * Good quality, reliable terminal/sockets are provided at appropriate places on panel for connections/ observation of waveforms.
- * Strongly supported by detailed Operating Instructions, giving details of Object, Theory, Design procedures, Report Suggestions and Book References.

Other Apparatus Required:

01. Decade Audio Frequency Generator 1
02. R.F. Signal Generator
03. A.C. Millivoltmeter

Study of Unijunction Transistor (U. J. T.)

Order Code - 36174



Experimental Training Board has been designed specifically to study different properties of Unijunction Transistor.

Practical experience on this board carries great educative value for Science and Engineering Students.

Object:

01. To plot V-I characteristics of a given U.J.T. (Unijunction Transistor).
02. To use the given U.J.T. as a Relaxation Oscillator.

Features:

The board consists of the following built-in parts :

01. Two 0-30V DC at 50mA, continuously variable regulated Power Supplies.
02. Digital Voltmeter DC $3\frac{1}{2}$ Digit having range of 0-200V.
03. Digital Current meter DC $3\frac{1}{2}$ Digit having range of 0-20mA
04. Uni-junction Transistor.
05. Adequate no. of other electronic components.
06. Mains ON/OFF switch, Fuse and Jewel light.
07. The unit is operative on 230V $\pm 10\%$ at 50Hz AC Mains.
08. Adequate no. of patch cords stackable from rear both ends 4mm spring loaded plug length $\frac{1}{2}$ meter.
09. Good quality, reliable terminal/sockets are provided at appropriate places on panel for connections/ observation of waveforms.
- * Strongly supported by detailed Operating Instructions, giving details of Object, Theory, Design procedures, Report Suggestions and Book References.

Timer Applications IC-555 No.1

Order Code - 36177



Experimental Training Board has been designed specifically to study various applications of Timer IC 555. This Training Board is useful to realise 50% Duty Cycle Oscillator, Ramp Generator, Time Delay Circuit, Sequence Generator, Schmitt Trigger, Monostable Multivibrator, Astable Multivibrator, Pulse Width Modulator, Pulse Position Modulator etc.

Practical experience on this board carries great educative value for Science and Engineering Students.

Object:

To study different applications of Timer IC 555.

Experiments:

To study the following :

01. Astable Multivibrator.
02. Mono-Stable Multivibrator.
03. Frequency Divider.
04. Linear Ramp Generator.
05. Square Wave Generator.
06. Missing Pulse Detector.
07. Pulse Width Modulation.
08. Pulse Position Modulation.
09. Schmitt Trigger.
10. Sequence Generator.
11. Bistable Multivibrator.
12. Simple Clock Generator.

Features:

The board consists of the following built-in parts :

01. +10 V at 100mA, IC regulated Power Supply.
02. Sine-Square Wave Generator of 100 Hz and 1 KHz respectively, using ICs.
03. Two Timer Ics 555.
04. Two Diodes and one PNP transistor.
05. Two Potentiometers.
06. Adequate no. of other electronic components.
07. Mains ON/OFF switch and Jewel light.
- * The unit is operative on 230V \pm 10% at 50Hz A.C. Mains.
- * Adequate no. of patch cords stackable from rear both ends 4mm spring loaded plug length ½ metre.
- * Good quality, reliable terminal/sockets are provided at appropriate places on panel for connections/ observation of waveforms.
- * Strongly supported by detailed Operating Instructions, giving details of Object, Theory, Design procedures, Report Suggestions and Book References.

Active Filters

Order Code - 36178



Experimental Training Board has been designed

specifically to study characteristics of various types of Active Filters. This Training Board includes low pass, high pass, band pass and notch filters. The filter circuits are designed using second order Butter worth polynomials and provide unity gain in the pass band. Practical experience on this board carries great educative value for Science and Engineering Students.

Object:

To study characteristics of various Active Filters.

Specifications:

1. LOW PASS FILTER
 - (a) Upper Cut-off frequency : 1 KHz
 - (B) Cut-off slope : 29.5 dB/decade
 - (c) Input impedance : 3.5 K at 1KHz
 - (d) Output impedance : 18 Ohms at 1KHz
2. HIGH PASS FILTER
 - (a) Lower cut-off frequency : 100 Hz
 - (b) Cut-off slope : 26 dB/decade
 - (c) Input impedance : 12 K at 100 Hz
 - (d) Output impedance : 30 Ohms at 100 Hz
3. BAND PASS FILTER
 - (a) Upper cut-off frequency : 1 KHz
 - (B) Lower cut-off frequency : 100 Hz
 - (c) Upper cut-off slope : 29.5 dB/decade
 - (d) Lower cut-off frequency : 26 dB/decade
 - (e) Input impedances : 24 K at 100 Hz , 3.5 K at 1 KHz
 - (F) Output impedances : 30 Ohms at 100 Hz, 27 Ohms at 1 KHz
4. NOTCH FILTER
 - (A) Notch frequency : 1 KHz
 - (B) Input impedance : 15 K at 1 KHz
 - (c) Output impedance : 25 ohms at 1 KHz
 - (d) Notch width : 100 Hz

Features

The board consists of the following built-in parts :

01. \pm 12V DC at 50mA, IC regulated Power Supply internally connected.
02. Four Operational Amplifier ICs.
03. Adequate no. of other electronic components.
04. Mains ON/OFF switch and Jewel light.
- * The unit is operative on 230V \pm 10% at 50Hz A.C.
- * Adequate no. of patch cords stackable from rear both ends 4mm spring loaded plug length ½ metre.
- * Good quality, reliable terminal/sockets are provided at appropriate places on panel for connections/ observation of waveforms.
- * Strongly supported by detailed Operating Instructions, giving details of Object, Theory, Design procedures, Report Suggestions and Book References.

MOS-FET Characteristics

Order Code - 36179



Experimental Training Board has been specifically designed to study the characteristics of MOSFET (Metal Oxide Semiconductor Field Effect Transistor) and its use as an amplifier.

Practical experience on this board carries great educative value for Science and Engineering Students.

Object:

01. To determine experimentally the Drain characteristics of a given MOSFET.
02. To study the use of MOSFET as an amplifier and to measure its voltage gain in common source configuration.

Features:

The board consists of following built-in parts:

01. 0-15V D.C. at 50mA, continuously variable regulated Power Supply.
 02. 0-4V D.C. at 10mA, continuously variable regulated Power Supply.
 03. 0-1V D.C. at 10mA, continuously variable regulated Power Supply.
 04. Digital Voltmeter DC 3½ Digit range of 20V.
 05. Digital Current meter DC 3½ Digit range of 20mA .
 06. Metal Oxide Semiconductor Field Effect Transistor (MOSFET).
 07. Adequate no. of other electronic components.
 08. Mains ON/OFF switch, Fuse and Jewel light.
- * The unit is operative on 230V ±10% at 50Hz A.C. Mains.
 - * Adequate no. of patch cords stackable from rear both ends 4mm spring loaded plug length ½ metre.
 - * Good Quality, reliable terminal/sockets are provided at appropriate places on panel for connections/ observation of waveforms.
 - * Strongly supported by detailed Operating Instructions, giving details of Object, Theory, Design procedures, Report Suggestions and Book References.

Voltage Regulator Tube Characteristics (Valve Version)

Order Code - 36180



Experimental Training Board has been designed specifically to study the characteristics of Voltage Regulator Tube.

Practical experience on this board carries great educative value for Science and Engineering Students.

Object:

01. To study and plot the variation in output voltage with variation of load keeping input voltage constant.
02. To study and plot the variation in output voltage with the variation of input voltage keeping load constant.

Features:

The board consists of following built-in parts:

01. DC Voltmeter, 65mm rectangular dial to read 0-200V, for measuring load voltages.
 02. DC Milliammeter, 65mm rectangular dial to read 0-60mA, for measuring load current.
 03. Valve fixed on panel with 9 pin valve base .
 04. Necessary load provided on the front panel.
 05. Adequate no. of other electronic components.
- * Adequate no. of patch cords stackable from rear both ends 4mm spring loaded plug length ½ metre.

- * Good quality, reliable terminal/sockets are provided at appropriate places on panel for connections/ observation of waveforms.
- * Strongly supported by detailed Operating Instructions, giving details of Object, Theory, Design procedures, Report Suggestions and Book References.
- * The unit is operative on 230V ±10% at 50Hz A.C. Mains.
- * Adequate no. of patch cords stackable from rear both ends 4mm spring loaded plug length ½ metre.
- * Good quality, reliable terminal/sockets are provided at appropriate places on panel for connections/ observation of waveforms.
- * Strongly supported by detailed Operating Instructions, giving details of Object, Theory, Design procedures, Report Suggestions and Book References.

Junction Diode Rectifier & Filter Characteristics

Order Code - 36182



Experimental Training Board has been designed specifically for the Study of the Junction Diode Rectifier and Filter Characteristics.

Practical experience on this board carries great educative value for Science and Engineering Students.

Object:

Study of Junction Diode Rectifier & Filter characteristics.

01. Study of Junction Diode Rectifier output and ripple content for different resistive loads for :
 - (a) Half wave.
 - (b) Full wave (Centre Tap).
 - (c) Full wave (Bridge).
 - (d) Voltage Doubler Circuit.
02. Study of filter and load regulation characteristics for half wave and full wave rectifier having different resistive loads and filters of the type
 - (a) Capacitor filter.
 - (b) Capacitor Filter with capacitor value doubled.
 - (c) Inductor filter.
 - (d) Capacitor input L section filter.
 - (e) Capacitor input p section filter.

Features:

The board consists of the following built-in parts :

1. Mains transformer, secondary centre tap 100-0-100V at 100mA.
2. Digital Voltmeter DC 3½ Digit having range of 1000V.
3. Digital Current meter DC 3½ Digit having range of 200mA.
4. Four Silicon Junction Diodes.
5. Filter choke.
6. Adequate no. of other electronic components.
7. Mains ON/OFF switch, Fuse and Jewel light.
8. The unit is operative on 230V ±10% at 50Hz AC Mains.
9. Adequate no. of patch cords stackable from rear both ends 4mm spring loaded plug length ½ meter.

- * Good quality, reliable terminal/sockets are provided at appropriate places on panel for connections/ observation of waveforms.
- * Strongly supported by detailed Operating Instructions, giving details of Object, Theory, Design procedures, Report Suggestions and Book References.

Charging and Discharging of a Condenser

Order Code - 36183



Experimental Training Board has been specifically designed to study Charging and Discharging of a Condenser.

Practical experience on this board carries great educative value for Science and Engineering Students.

Object:

01. To study the charging of a condenser, to plot a graph of voltage (V) across it against time (t) and to determine the time constant from this graph.
02. To plot a graph of charging current (i) against time (t) and to determine the time constant from this graph.
03. To study the discharging of a condenser, to plot a graph of voltage (V) across the condenser against time (t) and to determine the time constant from this graph.
04. To plot a graph of discharge current (i) against time (t) and to determine the time constant from this graph.

Features:

The board consists of the following built-in parts :

01. 0-20V D.C. at 25 mA, continuously variable regulated Power Supply.
 02. Digital Voltmeter DC 3½ Digit having Dual range of 2V / 20V.
 03. Digital Current meter DC 3½ Digit range of 20mA
 04. Three SPDT switches.
 05. Four electrolytic condensers.
 06. Adequate no. of other electronic components.
 07. Mains ON/OFF switch, Fuse and Jewel light.
- * The unit is operative on 230V ±10% at 50Hz A.C. Mains.
 - * Adequate no. of patch cords stackable from rear both ends 4mm spring loaded plug length ½ metre.
 - * Good Quality, reliable terminal/sockets are provided at appropriate places on panel for connections/ observation of waveforms.
 - * Strongly supported by detailed Operating Instructions, giving details of Object, Theory, Design procedures, Report Suggestions and Book References.

Semiconductor Devices Characteristics

Order Code - 36184



Experimental Training Board has been designed specifically to study the Characteristics of a large family of Semiconductor Devices.

Practical experience on this board carries great educative value for Science and Engineering Students.

Object:

To study the characteristics of the following electronic devices :

01. Germanium and Silicon Diodes.
02. Zener Diodes.
03. Transistor (Bipolar) PNP and NPN.
04. Field Effect Transistor (FET).
05. Uni-Junction Transistor (UJT).
06. Light Emitting Diode (LED).
07. Photo Diode.
08. Photo Transistor .
09. Thermistors N.T.C. and P.T.C.
10. Voltage Dependant Resistor (V.D.R.).
11. Light Dependant Resistor (L.D.R.).
12. Opto-Coupler.
13. DIAC.
14. Silicon Controlled Rectifier (SCR).
15. TRIAC.
16. Varactor Diode (Varicap Diode).

Features:

The board consists of the following built-in-parts:

01. Two, 0-1.5V DC, 0-10V DC and 0-25V DC at 500mA, IC Regulated Power Supplies (switch selectable).
 02. 0-50V D.C. at 100mA, continuously variable regulated Power Supply.
 03. Two, D.C. Ammeters, 65mm rectangular dial with switch selectable ranges of 50mA, 500mA, 5mA, 50mA and 500mA.
 04. D.C. Voltmeter, 65mm rectangular dial with switch selectable ranges of 1V, 10V and 50V.
 05. Electronic devices (all as mentioned under heading "OBJECT").
 06. Adequate no. of other electronic components.
 07. Mains ON/OFF switch, Fuse and Jewel light.
- * The unit is operative on 230V±10% at 50Hz A.C. Mains.
 - * Adequate no. of patch cords stackable from rear both ends 2mm spring loaded plug length ½ metre.
 - * Good quality, reliable terminal/sockets are provided at appropriate places on panel for connections/ observation of waveforms.
 - * Strongly supported by detailed Operating Instructions, giving details of Object, Theory, Design procedures, Report Suggestions and Book References.

Semiconductor Characteristics

Order Code - 36184A



Experimental Training Board has been designed specifically to study the Characteristics of a large family of Semiconductor Devices.

Practical experience on this board carries great

educative value for Science and Engineering Students.

Object:

To study the characteristics of the following electronic devices :

01. Light Emitting Diode (LED).
02. Thermistors N.T.C.
03. Light Dependant Resistor (L.D.R.).
04. Voltage Dependent resistor (V.D.R.).

Features:

The board consists of the following built-in-parts:

01. One, 0-10V DC at 20mA, IC Regulated Power Supplies.
 02. Digital voltmeter DC 3½ digit range of 20V.
 03. Digital current meter DC 3½ digit having dual range of 200mA / 20mA.
 04. Electronic devices (all as mentioned under heading "OBJECT").
 05. Adequate no. of other electronic components.
 06. Mains ON/OFF switch, Fuse and Jewel light.
- * The unit is operative on 230V±10% at 50Hz A.C. Mains.
 - * Adequate no. of patch cords stackable from rear both ends 2mm spring loaded plug length ½ metre.
 - * Good quality, reliable terminal/sockets are provided at appropriate places on panel for connections/observation of waveforms.
 - * Strongly supported by detailed Operating Instructions, giving details of Object, Theory, Design procedures, Report Suggestions and Book References.

Discrete Component Trainer

Order Code - 36185



Experimental Training Board has been designed specifically for the study of Discrete Electronic Components. It contains a wide selection of discrete components and A.C. & D.C. Power Supplies. The capabilities of this trainer extend far beyond the experiments described. Although only a finite number of experiments have been described yet other circuits as per individuals requirements can also be designed using the available components and power supplies. Practical experience on this board carries great educative value for Science and Engineering Students.

Object

* RC & LC CIRCUITS :

01. Study of RC High Pass Filter
02. Study of RC Low Pass Filter
03. Study of RL Differentiating Circuits
04. Study of Series RC Circuit
05. Study of Series LC Circuit
06. Study of Parallel RC Circuit
07. Study of Parallel LC Circuit

* SERIES & PARALLEL RESONANCE CIRCUIT :

01. Study of Series LCR Resonance Circuit and determination of 'Q'
02. Study of Parallel LCR Resonance Circuit
03. Determination of impedance & reactance of reactive elements and plotting of reactive curves

* GERMANIUM & SILICON DIODES :

01. Characteristics of a germanium diode
02. Characteristics of a silicon diode
03. Application of a diode as a half wave rectifier
04. Application of four diodes as full wave bridge rectifier

* ZENER DIODE :

01. Characteristics of a Zener Diode
02. Application of a Zener Diode as a voltage regulator
03. Determination of line regulation of a zener diode regulator circuit
04. Determination of load regulation of a zener diode regulator circuit

* CLIPPING & CLAMPING CIRCUITS :

01. Study of single level clipping circuits
02. Study of two level clipping circuits
03. Study of clamping circuits

* COMMON EMITTER CONFIGURATION OF A TRANSISTOR :

01. Input characteristics of common emitter configuration
02. Output characteristics of common emitter configuration
03. Study of common emitter amplifier

* COMMON BASE CONFIGURATION OF A TRANSISTOR:

01. Input characteristics of common base configuration
02. Output characteristics of common base configuration
03. Study of common base amplifier

* COMMON COLLECTOR CONFIGURATION OF A TRANSISTOR :

01. Transfer characteristics of common collector configuration

* EMITTER FOLLOWER (TRANSISTOR) :

01. Study of emitter follower configuration

* CASCADED AMPLIFIER :

01. Study of two stage cascaded amplifier

* POWER AMPLIFIER

01. Study of class-A power amplifier

* DIFFERENTIAL AMPLIFIER :

01. Study of a differential amplifier and determination of its CMRR

* FEED BACK AMPLIFIER

01. Study of current series feedback
02. Study of current shunt feedback

* SELECTIVE AMPLIFIER :

01. Study of frequency selective amplifier

* FET CHARACTERISTICS & SOURCE

FOLLOWER:

01. Study of static characteristics of an FET
02. Application as source follower

*** FET CHOPPER & V.V.R. (Voltage Variable Resistor)**

01. Application as a Chopper
02. Application as Voltage Variable Resistor (VVR)

*** R.C. PHASE SHIFT OSCILLATOR :**

01. Study of R.C. Phase Shift Oscillator

*** U.J.T. CHARACTERISTICS & RELAXATION OSCILLATOR :**

01. Study of UJT Characteristics
02. Application of UJT as relaxation oscillator

*** TRIAC CHARACTERISTICS :**

01. Terminal Characteristics in Mode I+
02. Terminal Characteristics in Mode III+
03. Measurement of Holding Current I_H
04. Gate characteristics in Mode I+
05. Gate characteristics in Mode I-
06. Gate characteristics in Mode III+
07. Gate characteristics in Mode III-
08. Application in power control using D.C. control voltage
09. Application in power control using A.C. control voltage

Voltage Regulator IC 723

Order Code - 36186



Experimental Training Board has been designed specifically to study Voltage Regulator IC 723. This Training Board gives a thorough understanding of the basic parameters of IC 723, their measurement and also covers useful applications of this regulator IC. The board is absolutely self contained and requires no other apparatus.

Practical experience on this board carries great educative value for Science and Engineering Students.

Object:

01. To study and measure the following parameters of IC 723 :
 - 1.1 Load Regulation.
 - 1.2 Line Regulation.
02. To study the following applications :
 - 2.1 Low voltage regulator circuit 2 to 7V.
 - 2.2 High voltage regulator circuit 7 to 27V.
 - 2.3 Voltage regulator with increased current capability using external NPN power transistor.
 - 2.4 Voltage regulator with increased current capability using external PNP power transistor.
 - 2.5 Voltage regulator with fold back current limiting.
 - 2.6 Negative voltage regulator.

Features:

The board consists of the following built-in parts :

01. 0-35V D.C. at 250mA, continuously variable unregulated Power Supply.

02. D.C. Milliammeter, 65mm Rectangular dial with switch selectable ranges of 50mA and 250mA.
 03. D.C. Voltmeter, 65mm rectangular dial with switch selectable ranges of 10V and 40V.
 04. IC 723 fitted on base.
 05. Three Potentiometers.
 06. Electronic load.
 07. NPN Power transistor.
 08. PNP Power transistor.
 09. Adequate no. of other electronic components.
 10. Mains ON/OFF switch, Fuse and Jewel light.
- * The unit is operative on 230V $\pm 10\%$ at 50Hz A.C. Mains.
- * Adequate no. of patch cords stackable from rear both ends 2mm spring loaded plug length $\frac{1}{2}$ metre.
- * Good quality, reliable terminal/sockets are provided at appropriate places on panel for connections/ observation of waveforms.
- * Strongly supported by detailed Operating Instructions, giving details of Object, Theory, Design procedures, Report Suggestions and Book References.

Three Terminal Voltage Regulator

Order Code - 36187



Experimental Training Board has been designed specifically for thorough understanding of Three Terminal Voltage Regulators of 78XX and 79XX series. Although these two series of regulators are designed for fixed voltage regulation, this training board explores various methods of raising the output voltage and also to continuously vary their output voltage.

Practical experience on this board carries great educative value for Science and Engineering Students.

Object:

01. To study the effect of capacitors at input and output of the regulator.
02. To study the effect of ground reference level on the output voltage.
03. To study the minimum voltage differential required for proper working of regulator.
04. To measure load regulation.
05. To study various ways to increase the output voltage.
06. To use as a continuously variable regulator.
07. To use additional power transistor for increasing the current capacity of the regulator.
08. To use two regulators for dual polarity output.

Features:

The board consists of the following built-in parts :

01. $\pm 12V$ D.C. at 500mA, unregulated Power Supply.
02. D.C. Ammeter, 65mm rectangular dial to read 0-1A.
03. D.C. Voltmeter, 65mm rectangular dial to read 0-20V.
04. Zener diode.
05. Regulator IC 7805.
06. Regulator IC 7905.
07. PNP Power Transistor.

08. NPN Low Power Transistor.
09. Potentiometer
10. Two Load Resistances.
11. Two Rectifier Diodes.
12. Adequate no. of other electronic components.
13. Mains ON/OFF Switch, Fuse and Jewel light.
- * The unit is operative on 230V \pm 10% at 50Hz A.C. Mains.
- * Adequate no. of patch cords stackable from rear both ends 2mm spring loaded plug length ½ metre.
- * Good Quality, reliable terminal/sockets are provided at appropriate places on panel for connections/ observation of waveforms.
- * Strongly supported by detailed Operating Instructions, giving details of Object, Theory, Design procedures, Report Suggestions and Book References.
- * Weight : 3 Kg. (Approx.)
- * Dimension : W 340 x H 110 x D 210

D.C. Power Supplies

Order Code - 36188



Experimental Training Board has been designed specifically for the study of D.C. Power Supplies using basic techniques of rectification, smoothing and regulation.

Practical experience on this board carries great educative value for Science and Engineering Students.

Object:

01. Study of basic techniques of D.C. Power Supplies :
 - 1.1 Use of a diode as a rectifier (Half wave rectification).
 - 1.2 Study of full wave rectification using a centre tapped transformer.
 - 1.3 Study of full wave rectification using a bridge rectifier.
 - 1.4 Using a zener diode for regulation.
 - 1.5 To use a transistor as a series regulator.
 - 1.6 To use a transistor as a shunt regulator.
 - 1.7 To study methods of ripple reduction.
02. To measure basic parameters on a D.C. Power Supply :
 - 2.1 Line regulation.
 - 2.2 Load regulation.
 - 2.3 Ripple factor.

Features:

The board consists of the following built-in parts :

01. 4V5-0-4V5 AC at 300mA Power Supply.
02. D.C Milliammeter, 65mm rectangular dial with switch selectable ranges of 50mA and 200mA.
03. AC/DC Voltmeter, 65mm rectangular dial with switch selectable ranges of 10V and 20V.
04. Four Rectifier diodes.
05. Choke.
06. Zener diode.
07. Two transistors, one NPN and one PNP.
08. Wire wound potentiometer, to be used as load.
09. Two Electrolytic Capacitors.
10. Adequate no. of other electronic components.

11. Mains ON/OFF switch, Fuse and Jewel light.
- * The unit is operative on 230V \pm 10% at 50Hz A.C. Mains.
- * Adequate no. of patch cords stackable from rear both ends 2mm spring loaded plug length ½ metre.
- * Good quality, reliable terminal/sockets are provided at appropriate places on panel for connections/ observation of waveforms.
- * Strongly supported by detailed Operating Instructions, giving details of Object, Theory, Design procedures, Report Suggestions and Book References.

Other Apparatus Required:

01. Cathode Ray Oscilloscope 20MHZ

Differential Comparator IC-710

Order Code - 36189



Experimental Training Board has been designed specifically for the study of Differential Comparator IC-710. This training board covers most of applications of IC-710 and makes the student familiar with its parameters and their measurements. In this training board, we can also study of IC-710 as a voltage comparator and schmitt trigger.

Practical experience on this board carries great educative value for Science and Engineering Students.

Object:

01. To study and measure the following basic parameters :
 - Open loop gain.
 - Differential input resistance.
 - Output resistance.
 - Input offset voltage.
 - Input offset current.
 - Full power response.
02. Study of useful applications of IC-710 :
 - Use of IC-710 as a voltage comparator.
 - Use of IC-710 as a Schmitt trigger.

Features:

The board consists of the following built-in parts:

01. +12V D.C. at 100mA, IC regulated Power Supply.
02. -6V D.C. at 100mA, IC regulated Power Supply.
03. D.C. Voltmeter, 65mm rectangular dial, with switch selectable ranges of 1V and 15V.
04. Differential comparator IC-710.
05. Two SPST toggle switches.
06. Two sets of three inter-connected sockets for multi-connections where ever required.
07. Adequate no. of other electronic components.
08. Mains ON/OFF switch, Fuse and Jewel light.
- * The unit is operative on 230V \pm 10% at 50Hz A.C. Mains.
- * Adequate no. of patch cords stackable from rear both ends 2mm spring loaded plug length ½ metre.
- * Good Quality, reliable terminal/sockets are provided at appropriate places on panel for connections & observation of waveforms.

- * Strongly supported by detailed Operating Instructions, giving details of Object, Theory, Design procedures, Report Suggestions and Book References.

Other Apparatus Required:

01. Decade Audio Frequency Generator
02. A.C. Millivoltmeter
03. Cathode Ray Oscilloscope 20MHz

Phase Locked Loop IC-565

Order Code - 36190



Experimental Training Board has been designed specifically for the study of Phase Locked Loop (PLL) IC 565. This training board covers most of the important parameters, characteristics and applications on Phase-locked Loop (PLL) IC 565.

Practical experience on this board carries great educative value for Science and Engineering Students.

Object:

To measure important parameters of Phase Locked Loop (PLL) IC 565 :

VCO Characteristics :

01. To study and measure the free running frequency or centre frequency of VCO.
02. To study the VCO sensitivity
03. To study the VCO linearity PLL Characteristics :
04. To study and measure the capture range and lock range.

PLL Applications :

01. Frequency synthesis
02. F.M. De-modulation
03. A.M. De-modulation

Features:

The board consists of following built-in parts:

1. $\pm 6V$ D.C. at 100mA, IC regulated Power Supply.
2. D.C. Voltmeter, 65mm rectangular dial, with switch selectable of ranges 1V and 10V.
3. Phase locked loop IC-565
4. Two sets of three inter connected sockets for multi-connections wherever required.
5. Adequate no. of other electronic components.
6. Mains ON/OFF switch, Fuse and Jewel light.
- * The unit is operative on 230V $\pm 10\%$ at 50Hz A.C. Mains.
- * Adequate no. of patch cords stackable from rear both ends 2mm spring loaded plug length $\frac{1}{2}$ metre.
- * Good Quality, reliable terminal/sockets are provided at appropriate places on panel for connections & observation of waveforms.
- * Strongly supported by detailed Operating Instructions, giving details of Object, Theory, Design procedures, Report Suggestions and Book References.

Hybrid Parameters of a Transistor

Order Code - 36191



Experimental Training Board has been designed specifically for the study of Hybrid Parameters of a transistor and to derive Z and Y parameters from the hybrid-parameter results.

Practical experience on this board carries great educative value for Science and Engineering Students.

Object:

01. To measure the hybrid-parameters i.e. h_{11} , h_{12} , h_{21} & h_{22} of a transistor, at 1 KHz and at different collector current values.
02. To derive Z and Y parameters from the hybrid parameter results.

Features:

The board consists of the following built in parts:

01. 0-2V5 D.C. at 100 mA, continuously variable Power Supply.
02. 0-9V D.C. at 100mA, continuously variable Power Supply.
03. D.C. Milliammeter, 65mm rectangular dial to read 0-10mA.
04. 1 KHz Sine Wave source with variable output level 0-1V.
05. PNP Germanium transistor
06. Adequate no. of other Electronic Components.
07. Mains ON/OFF switch, Fuse and Jewel light.
- * The unit is operative on 230V $\pm 10\%$ at 50Hz A.C. Mains.
- * Adequate no. of patch cords stackable from rear both ends 4mm spring loaded plug length $\frac{1}{2}$ metre.
- * Good Quality, reliable terminal/sockets are provided at appropriate places on panel for connections / observation of waveforms.
- * Strongly supported by detailed Operating Instructions, giving details of Object, Theory, Design procedures, Report Suggestions and Book References.

OP-AMP Parameters

Order Code - 36192



Experimental Training Board has been designed specifically for the study of electrical parameters of OP-AMP IC 741. Circuit designers and R & D labs will also benefit from this educative training board.

Practical experience on this board carries great educative value for Science and Engineering Students.

Object:

- To measure the following parameters on OP-AMP IC 741
01. Measurement of quiescent supply current of OP-AMP.
 02. To null the offset voltage of an OP-AMP.
 03. To measure open loop voltage gain under closed loop condition.
 04. To measure output resistance.

05. To measure differential input resistance.
06. To measure unity gain bandwidth.
07. To measure the rated output.
08. To measure the slewing rate.
09. To measure the full power response.
10. To measure the input offset voltage.
11. To measure the input bias currents and offset current.
12. To measure the common mode rejection ratio (CMRR).
13. To measure the common mode input resistance.

Features:

The board consists of the following built-in parts:

01. $\pm 12V$ D.C. at 100mA, IC regulated Power Supply.
02. OP-AMP IC-741.
03. DPM 20 V.
04. DPM 20 mA.
05. Adequate no. of other electronic components.
06. Mains ON/OFF switch and Fuse.
- * The unit is operative on 230V $\pm 10\%$ at 50Hz A.C. Mains.
- * Adequate no. of patch cords stackable from rear both ends 2mm spring loaded plug length $\frac{1}{2}$ metre.
- * Good Quality, reliable terminal/sockets are provided at appropriate places on panel for connections & observation of waveforms.
- * Strongly supported by detailed Operating Instructions, giving details of Object, Theory, Design procedures, Report Suggestions and Book References.

Other Apparatus Required:

01. Decade Audio Frequency Generator
02. A.C. Millivoltmeter
03. Cathode Ray Oscilloscope 20MHz

Reactive Elements & Time Dependent Network Analysis

Order Code - 36193



Experimental Training Board has been designed specifically to study the behavior of the Reactive Elements and Time Dependent Network Analysis. Practical experience on this board carries great educative value for Science and Engineering Students.

Object:

01. To study Charging & Discharging of a Condenser.
02. To Calibrate D.C. meter for A.C. voltage measurements.
03. To construct the vector (phasor) diagram for series L-R circuit and to calculate the power factor and "Q" at 50 Hz.
04. To study series LCR resonance circuit and its "Q".
05. To study series L-C resonance circuit and from it to find out the true value of "L".
06. To study series C-R circuit.
07. To study different types of filters.
08. To study the parallel R-C resonance circuit.
09. To study the parallel L-C resonance circuit and to find its "Q".
10. To verify circuit laws.

11. To find out the impedance and reactance of LCR reactive elements and to plot their reactance curves.
12. To plot "LISSAGOUS" figures.

Features:

The board consists of the following built-in parts:

01. Mains Transformer having secondary tappings of 10V, 20V, 30V, 40V, 50V A.C. at 500mA.
02. D.C. Voltmeter, 65mm rectangular dial with switch selectable ranges of 10V, 20V, 30V, 40V and 50V.
03. Four Rectifier diodes.
04. SPDT switch.
05. Potentiometer and adequate no. of other electronic components.
06. Mains ON/OFF switch, Fuse and Jewel light.
- * The unit is operative on 230V $\pm 10\%$ at 50Hz A.C. Mains.
- * Adequate no. of patch cords stackable from rear both ends 4mm spring loaded plug length $\frac{1}{2}$ metre.
- * Good quality, reliable terminal/sockets are provided at appropriate places on panel for connections & observation of waveforms.
- * Strongly supported by detailed Operating Instructions, giving details of Object, Theory, Design procedures, Report Suggestions and Book References.

Other Apparatus Required:

01. Decade Audio Frequency Generator
02. Digital Stop Clock
03. Cathode Ray Oscilloscope 20MHz

Oscillators (Various Type)

Order Code - 36194



Experimental Training Board has been designed specifically on sinusoidal Oscillators. In this training board all the basic sinusoidal oscillator circuits can be quickly and easily assembled and studied. Practical experience on this board carries great educative value for Science and Engineering Students.

Object:

01. To study R.C. Phase Shift Oscillator of phase advance type.
02. To study R.C. Phase Shift Oscillator of phase retard type.
03. To study Wien-Bridge Oscillator.
04. To study Hartely's Oscillator.
05. To study Colpitt's Oscillator.
06. To study Pierce (X-Tal) Oscillator.
07. To study method of frequency measurement using a CRO.

Features:

The board consists of the following built-in parts:

01. +9V D.C at 100mA, IC Regulated Power Supply.
02. Two stage buffer/amplifier using PNP transistors and controllable A.C. gain.
03. NPN Transistor biased in Class A common emitter configuration.
04. Wien-bridge network.

05. R.C. Phase Shift Net-work (advance type & retard type).
06. Tank circuits for Hartley's & Colpitt's Oscillators.
07. 3.579 MHz X-tal with series trimmer.
08. Adequate no. of other electronic components.
09. Mains ON/OFF switch, Fuse and Jewel light.
- * The unit is operative on 230V $\pm 10\%$ at 50Hz A.C. Mains.
- * Adequate no. of patch cords stackable from rear both ends 4mm spring loaded plug length $\frac{1}{2}$ metre.
- * Good quality, reliable terminal/sockets are provided at appropriate places on panel for connections & observation of waveforms.
- * Strongly supported by detailed Operating Instructions, giving details of Object, Theory, Design procedures, Report Suggestions and Book References.

Multivibrators (Solid State)

Order Code - 36195



Experimental Training Board has been designed specifically for the study of Multivibrator circuits. Apart from basic circuits some special techniques have also been included.

Practical experience on this board carries great educative value for Science and Engineering Students.

Object:

To study multivibrator circuits.

Experiments:

01. Design of multivibrators.
02. To study the waveforms of a free running multivibrator.
03. To design and make a bistable multivibrator and to study its D.C. conditions.
04. To design and make a monostable multivibrator and to adjust its delay time.
05. To design and make schmitt-trigger and study its hysteresis.
06. To control the frequency of a free running multivibrator with applied voltage.
07. To design and make a gated free running multivibrator.
08. To design and make an improved free running multivibrator.

Features:

The board consists of the following built-in parts :

01. $\pm 9V$ D.C. at 100mA, IC regulated Power Supply.
02. 0-9V D.C. at 5mA, IC regulated Power Supply.
03. Digital Voltmeter DC $3\frac{1}{2}$ Digit range of 0-20V.
04. Pulser for triggering the circuit.
05. Three NPN transistors.
06. Adequate no. of other Electronic Components.
07. Mains ON/OFF switch, Fuse and Jewel light.
- * The unit is operative on 230V $\pm 10\%$ at 50Hz A.C. Mains.
- * Adequate no. of patch cords stackable from rear both ends 4mm spring loaded plug length $\frac{1}{2}$ metre.

- * Good Quality, reliable terminal/sockets are provided at appropriate places on panel for connections & observation of waveforms.
- * Strongly supported by detailed Operating Instructions, giving details of Object, Theory, Design procedures, Report Suggestions and Book References.

Operational Amplifier Designer

Order Code - 36197



Order Code - 36197 "OP-AMP DESIGNER" has been designed specifically for the study of OP-AMP IC and its applications. This training board covers nearly all possible applications of operational amplifiers IC and makes the student familiar with the fundamentals of OP-AMPS, their characteristics and applications in various fields. 100 experiments can be performed by this OP-AMP designer.

Practical experience on this board carries great educative value for Science and Engineering Students.

LIST OF EXPERIMENTS

Following experiments can be performed :

01. BASIC OPERATIONAL AMPLIFIER CIRCUIT

01. Inverting Amplifier
02. Non-inverting Amplifier
03. Inverting A.C. Amplifier
04. Non-inverting A.C. Amplifier
05. High input impedance inverting Amplifier
06. High input impedance non-inverting amplifier

02. SOURCE FOLLOWERS

01. Voltage Follower (Unit gain buffer amplifier)
02. A.C. Voltage follower

03. OP- AMPS AS ANALOGUE COMPUTER ELEMENTS

01. Inverting summing amplifier
02. Non-inverting summing amplifier
03. Subtractor
04. Differential amplifier
05. A.C. differential amplifier
06. Adder subtractor
07. Multiplication by a constant
08. Division by a constant
09. Integrating amplifier for DC input signals
10. Integrating amplifier for AC input signals
11. Differentiator amplifier
12. Non-inverting differentiator

04. FUNCTION GENERATOR

01. Sine Wave generator using wien bridge network
02. Square Wave generator
03. Pulse generator
04. Square and Triangular wave generator
05. Saw tooth generator
06. Synchronised sawtooth generator with negative going pulse trigger
07. Synchronised sawtooth generator with positive going pulse trigger

05. MULTIVIBRATORS

01. Astable multivibrator
02. Monostable multivibrator
03. Bistable multivibrator

06. FILTERS

01. Low pass active filter
02. High pass active filter
03. Band pass active filter
04. Notch filter

07. VOLTAGE AND CURRENT REGULATOR

01. Basic reference voltage source
02. Basic reference voltage source with buffered output
03. Basic reference voltage source with negative output
04. Negative voltage reference source with buffered output
05. Positive regulator with variable buffered output
06. Negative regulator with variable buffered output
07. Buffered reference source
08. Basic non-inverting voltage controlled current source

08. SIGN CHANGER

01. Sign changer with variable output
02. Switch select sign changer

09. PHASE SHIFT CIRCUIT

01. Constant amplitude lag circuit
02. Constant amplitude lead circuit

10. SIGNAL PROCESSING CIRCUITS

01. Diodes
 - * Precision Diode with +O/P
 - * Precision Diode with -O/P
02. Rectifier
 - * Half wave rectifier
 - * Full wave rectifier
 - * Filtered full wave rectifier
03. Detectors
 - * Peak detector
 - * Buffered peak detector
 - * Inverting peak detector
 - * Zero crossing detector
 - * Buffered zero crossing
04. Clippers
 - * Positive peak clipper
 - * Negative peak clipper
 - * Self buffered series clipper
 - * Shunt clipper
 - * DC restorer
05. Dead Band Response
 - * Feed back circuit with dead band response
 - * Variable dead band circuit

11. LIMITERS

01. General purpose unipolar limiter
02. Bipolar zener limiter
03. Input current limiter
04. Diode bridge limiter using one zener
05. Adjustable bipolar limiter

12. COMPARATORS

01. Fast precision voltage comparator
02. Single ended comparator with hysteresis & clamped feed back
03. Comparator for signals of opposite polarity
04. Comparator for A.C. coupled signals

13. INSTRUMENTATION AMPLIFIER

01. Basic differential input instrumentation amplifier
02. Instrumentation amplifier with high input impedance

14. OUTPUT DISPLAYS FOR COMPARATOR

01. LED driver
02. Lamp driver

15. METERING CIRCUITS

01. D.C. voltmeter

02. D.C. ammeter

03. Resistance to voltage converter

16. LATCH UP PROTECTION

01. Elimination of latch up

17. PUSH PULL CONVERSION

01. Single ended to push pull conversion

18. MODULATION

01. Pulse amplitude modulation

19. OFF-SET ADJUSTMENT IN OP-AMP CIRCUITS

01. Internal off set Nulling
 01. For inverting amplifier
 02. For non-inverting amplifier
 03. For voltage follower
02. Universal External off set Nulling
 01. Inverting amplifier offset voltage applied to the inverting input
 02. Inverting amplifier offset voltage applied to the noninverting input
 03. Off-setting circuit for low gain non-inverting amplifier
 04. Off-setting circuit for high gain non-inverting amplifier
 05. Off-setting circuit for voltage follower
03. Other types of off-setting arrangements
 01. Zero off-setting
 02. Zero off-setting buffer

20. MEASUREMENT OF OP-AMP PARAMETERS

01. Measurement of closed loop gain
02. Measurement of closed loop-r (inverting mode) in
03. Measurement of closed loop-r (non-inverting mode) in
04. Measurement of O/P resistance (closed loop)
05. Measurement of Band width of ac amplifier
06. Input off-set voltage
07. Input bias current
08. Input off-set current

Features :

The board consists of the following built-in parts:

01. IC Regulated D.C. Power Supply.
 02. Continuously variable D.C. Power Supply.
 03. Two OP-Amp IC.
 04. Transistor, 5 diodes, 2 zener diodes, 28 resistors, 8 capacitors, one LED, one lamp.
 05. Mains ON/OFF switch, fuse and Neon Indicator are provided.
- * The unit is operative on 230V, 50Hz A.C.
 - * Adequate no. of patch cords stackable from rear both ends 4mm spring loaded plug length ½ metre.
 - * Good Quality, reliable terminal/sockets are provided at appropriate places on panel for connections/ observation of waveforms.
 - * Strongly Supported by Detailed operating Instructions, giving details of Object, Theory, Design procedures, Report Suggestions and Book References.

Variable Three Terminal Voltage Regulator

Order Code - 36198



Experimental Training Board has been specifically designed to study various parameters and applications

of versatile Variable Three Terminal Voltage Regulator IC LM 317. This regulator IC simplifies the design of good quality power supplies. The board is absolutely self contained and requires no other apparatus. Practical experience on this board carries great educative value for Science and Engineering Students.

Object:

- 01 To study and measure the following parameters :
 - (a) Measurement of load regulation of IC LM 317.
 - (b) Study of short circuit shut down of LM 317.
- 02 To study the following applications of IC LM 317 :
 - (a) 1.25 to 20 Volt variable voltage regulator.
 - (b) Increasing the current capacity using external power transistor.
 - (c) Short circuit current limiting by using an external transistor.
 - (d) 0 to 20 Volt variable voltage regulator.

Features:

The board consists of the following built-in parts :

01. +25V D.C. at 2 Amp., Unregulated Power Supply.
02. -6V D.C. at 100mA , Unregulated Power Supply.
03. Digital voltmeter DC 3½ digits having range 0-20V.
04. Digital current meter DC 3½ digits having range 0-2 Amp.
05. IC LM 317.
06. PNP Power transistor.
07. Electronic load & Potentiometer.
08. Adequate no. of other electronic components.
09. Mains ON/OFF switch and fuse.
- * The unit is operative on 230V \pm 10% at 50Hz A.C. Mains.
- * Adequate no. of patch cords stackable 4mm spring loaded plug length ½ metre.
- * Good Quality, reliable terminal/sockets are provided at appropriate places on panel for connections & observation of waveforms.

Peak & Average Voltage Determination in an A.C. Circuit

Order Code - 36199



Experimental Training Board has been designed specifically for the determination of peak and average voltage of an A.C. circuit. The board is absolutely self contained and requires no other apparatus. Practical experience on this board carries great educative value for Science and Engineering Students with B.Sc students in particular.

Object:

01. To determine the peak voltage of A.C. and from it to calculate the average voltage of rectified half wave A.C.
02. To determine the peak value of A.C. by null deflection method.

Features:

The unit consists of the following built-in parts:

01. +12V D.C. at 10mA, IC regulated Power Supply.
02. Mains step down transformer having secondary

tapping 3V, 4.5V, 6V and 9V A.C. at 10mA.

03. A.C. / D.C. Voltmeter, 65mm rectangular dial, with A.C. and D.C. switch selectable range of 0-15V.
04. D.C. Voltmeter, 65mm rectangular dial to read 0-15V.
05. Two SPST switches, potentiometer and a diode.
06. Adequate no. of other electronic components.
07. Mains ON/OFF switch, Fuse and Jewel light.
- * The unit is operative on 230V \pm 10% at 50Hz A.C. Mains.
- * Adequate no. of patch cords stackable from rear both ends 4 mm spring loaded plug length ½ metre.
- * Good Quality, reliable terminal/sockets are provided at appropriate places on panel for connections.
- * Strongly supported by detailed Operating Instructions, giving details of Object, Theory, Design procedures, Report Suggestions and Book References.

To Convert A Galvanometer Into Volt / Amp. Meter and To Study Resistance Laws & A Multimeter

Order Code - 36200



Experimental Training Board has been designed specifically for a detailed practical study of conversion of a Galvanometer into a Volt / Amp meter and study of the laws of Resistances. The unit has an added feature that you can also learn to use a Multimeter. Practical experience on this board carries great educative value for Science and Engineering Students particularly for Students of B.Sc and 10+2 classes.

Object:

01. To determine the resistance of a Galvanometer by half deflection method.
02. To determine the figure-of-merit of a Galvanometer.
03. To convert a Galvanometer into an Ammeter of a given range and to calibrate it.
04. To convert a Galvanometer into a Voltmeter of a given range and to calibrate it.
05. To study the laws of Resistances using an Ammeter.
06. To study the laws of Resistances using a Voltmeter.
07. To study the laws of Resistances using a Wheatstone Bridge.
08. To study the laws of Resistances using a Post Office Box.
09. To use a Multimeter for measuring :
 - (a) Resistances.
 - (b) Resistances in series.
 - (c) Resistances in parallel.
 - (d) DC Voltage.
 - (e) DC Current.

Features:

The board consists of the following built-in parts:

01. Galvanometer, 65mm rectangular dial to read 30-0-30.

02. 1.25 -30V D.C at 50 mA, continuously variable IC regulated Power Supply.
 03. 30V A.C. at 100 mA, power supply.
 04. Five Potentiometers and adequate no. of other electronic components.
 05. Mains ON/OFF switch, Fuse and Jewel light.
- * The unit is operative on 230V \pm 10% at 50Hz A.C. Mains.
 - * Adequate no. of patch cords stackable from rear both ends 4 mm spring loaded plug length $\frac{1}{2}$ metre.
 - * Good Quality, reliable terminal/sockets are provided at appropriate places on panel for connections.
 - * Strongly supported by detailed Operating Instructions, giving details of Object, Theory, Design procedures, Report Suggestions and Book References.

Other Apparatus Required:

01. Digital Multimeter 3 $\frac{3}{4}$ digit 1
02. Post Office Box

Phase Difference in L.C.R. Circuits

Order Code - 36201

Experimental Training Board has been designed specifically for the complete study of the phase difference in L.C.R. circuits. A selection of L,C and R values have been provided and phase difference in various combinations of L-C, L-R, C-R and L-C-R circuits can be studied in depth. The board is absolutely self contained and requires no other apparatus.

Practical experience on this board carries great educative value for Science and Engineering Students particularly for Students of B.Sc and 10+2 classes.

Object:

To study the phase difference in L-C, L-R, C-R and L-C-R circuits by :

- (a) Vector diagram method.
- (b) Superposition method.

Features:

The board consists of the following built-in parts:

01. Mains step down transformer having secondary tappings at 10V, 20V, 30V, 50V, 80V, 100V and a separate winding for standard voltage (Vs) supply of 12V at 500mA.
 02. A.C. Voltmeter, 65mm rectangular dial, with switch selectable ranges of 10V, 100V and 200V.
 03. Wire wound potentiometer, four inductors & adequate no. of other electronic components.
 04. Mains ON/OFF switch, Fuse and Jewel light.
- * The unit is operative on 230V \pm 10% at 50Hz A.C. Mains.
 - * Adequate no. of patch cords stackable from rear both ends 4 mm spring loaded plug length $\frac{1}{2}$ metre.
 - * Good Quality, reliable terminal/sockets are provided at appropriate places on panel for connections.
 - * Strongly supported by detailed Operating Instructions, giving details of Object, Theory, Design procedures, Report Suggestions and Book References.
 - * Weight : 9 Kg. (Approx.)
 - * Dimension : W 300 x H 140 x D 200

Integrating System Using Junction Diode

Order Code - 36202



Experimental Training Board has been designed specifically to study an integrating system using a junction diode, with unidirectional varying alternating and sinusoidal voltages. The special feature of this unit is a built-in unidirectional varying (voltage pulse) waveform generator. The performance of experiments using the output of this generator becomes easy although if desired an external rheostat may be used for generating unidirectional varying / alternating voltages.

Practical experience on this board carries great educative value for Science and Engineering Students particularly for Students of B.Sc and 10+2 Classes.

Object:

01. Charging of a condenser by unidirectional varying voltage pulses and then integrate them.
02. Charging of a condenser by alternating voltage pulses and then to integrate them.
03. Charging of a condenser by sinusoidal voltage pulses and then to integrate them.

Features:

The board consists of the following built-in parts:

01. Unidirectional varying alternating (voltage pulse) waveform generator, with switch selectable type and shape of output pulses.
 02. Mains transformer with tappings of 0V, 4V5, 5V, 6V and 9VA.C. at 100mA.
 03. +12V D.C. at 100mA, IC regulated Power Supply (for use with rheostat).
 04. A.C. / D.C. Voltmeter, 65mm rectangular dial, with A.C. and D.C. switch selectable range of 0-15V.
 05. Silicon Junction Diode, Push to ON Switch and Toggle Switch.
 06. Adequate no. of other Electronic Components.
 07. Mains ON/OFF switch, Fuse and Jewel light.
- * The unit is operative on 230V \pm 10% at 50Hz A.C. Mains.
 - * Adequate no. of patch cords stackable from rear both ends 4 mm spring loaded plug length $\frac{1}{2}$ metre.
 - * Good Quality, reliable terminal/sockets are provided at appropriate places on panel for connections.
 - * Strongly supported by detailed Operating Instructions, giving details of Object, Theory, Design procedures, Report Suggestions and Book References.

Other Apparatus Required:

01. Metronome
02. Rheostat (OPTIONAL)

Transistor Biasing Techniques and Stability

Order Code - 36203



Experimental Training Board has been designed specifically to study different biasing techniques for transistor amplifier circuits. Also the effect of transistor replacement (change in β) and temperature changes can be studied on all biasing circuits.

Practical experience on this board carries great educative value for R & D labs, Science and Engineering Students.

Object:

01. Study of Q-point variation due to transistor replacement (Changes in β) in:
 - (i) Fixed-bias circuit.
 - (ii) Collector to base bias circuit.
 - (iii) Self bias (Emitter bias) circuit.
 - (iv) Self bias (Emitter bias) in addition to voltage divider bias circuit.
02. A qualitative comparison of the effect of temperature on bias stability of the above four biasing circuits.

Features:

The board consists of the following built-in parts:

01. Two germanium NPN transistors one having low β and the other having high β .
02. +12V DC at 100mA, IC regulated Power Supply.
03. 1 KHz Sine Wave signal generators having 0-1 volt variable output level.
04. D.C. Microammeter, 65mm rectangular dial to read 0-100mA, for base current measurement.
05. D.C. Milliammeter, 65mm rectangular dial to read 0-25mA, for collector current measurement.
06. D.C. Voltmeter, 65mm rectangular dial to read 0-15V.
07. Electric oven for heating up the transistor.
08. Thermometer clamp for holding a thermometer. A Thermometer of 0-100°C provided along with the unit.
09. Adequate no. of other electronic components.
10. Mains ON/OFF switch, Fuse and Jewel light.
 - * The unit is operative on 230V \pm 10% at 50Hz A.C. Mains.
 - * Adequate no. of patch cords stackable from rear both ends 4 mm spring loaded plug length 1/2 metre.
 - * Good Quality, reliable terminal/sockets are provided at appropriate places on panel for connections & observation of waveforms.
 - * Strongly supported by detailed Operating Instructions, giving details of Object, Theory, Design procedures, Report Suggestions and Book References.

Study of Voltage and Current Regulated Power Supplies

Order Code - 36204



Experimental Training Board has been designed specifically for the study of difference between Voltage Regulated and Current Regulated Power Supplies. Certain basic circuits used in such supplies can be assembled and studied on this training board. The board is absolutely self contained and requires no other

apparatus.

Practical experience on this board carries great educative value for Science and Engineering Students.

Object:

01. To study a zener diode voltage regulator.
02. To study a series pass transistors voltage regulator.
03. To study an IC voltage regulator.
04. To study a transistor current regulator employing one of the following devices :
 - (a) Zener Diode
 - (b) Silicon Diodes
 - (c) LED
05. To study an IC current regulator.

Features:

The board consists of following built-in parts :

01. Mains transformer with tapings for 0,9 and 14VA.C. at 150mA.
02. D.C. Milliammeter, 65mm rectangular dial, having three ranges 1mA, 10mA, 100mA selected by switch.
03. D.C. Voltmeter, 65mm rectangular dial to read 0-30V.
04. Voltage Regulator.
05. NPN Transistor.
06. Zener Diode.
07. Adequate no. of other electronic components.
08. Mains ON/OFF switch, Fuse and Jewel light.
 - * The unit is operative on 230V \pm 10% at 50Hz A.C. Mains.
 - * Adequate no. of patch cords stackable from rear both ends 2mm spring loaded plug length 1/2 metre.
 - * Good Quality, reliable terminal/sockets are provided at appropriate places on panel for connections/observation of waveforms.
 - * Strongly supported by detailed Operating Instructions, giving details of Object, Theory, Design procedures, Report Suggestions and Book References.

Switching Mode Power Supply (SMPS)

Order Code - 36205



Experimental Training Board has been designed to practically demonstrate the operation of a Switching Mode Power Supply. The Switching waveform and various voltages can be observed on the test points provided on the panel.

Practical experience on this board carries great educative value for Science and Engineering Students.

Object:

01. To observe various voltages and Switching waveforms on the SMPS Circuit.
02. To demonstrate the effect of load variation on the switching waveform.
03. To measure the following :
 - (a) Ripple.
 - (b) Load regulation.
 - (c) Line regulation.

Features:

The board consists of following built-in parts :

01. Complete SMPS circuit based on IC-723, having output 5V D.C. at 1.5 Amp.
 02. D.C. Voltmeter, 65mm rectangular dial to read 0-30V.
 03. D.C. Ammeter, 65mm rectangular dial to read 0-2Amp.
 04. Three fixed value loads.
 05. Mains ON/OFF switch, Fuse and Jewel light.
- * The unit is operative on 230V \pm 10% at 50Hz A.C. Mains.
 - * Adequate no. of patch cords stackable from rear both ends 4mm spring loaded plug length ½ metre.
 - * Good Quality, reliable terminal/sockets are provided at appropriate places on panel for connections & observation of waveforms.
 - * Strongly supported by detailed Operating Instructions, giving details of Object, Theory, Design procedures, Report Suggestions and Book References.

Other Apparatus Required:

01. Cathode Ray Oscilloscope 20MHz
02. Variac 0-270 Volt at 2 Amp

Transistor Series and Shunt Voltage Regulated Power Supplies

Order Code - 36206



Experimental Training Board has been designed specifically for the study of transistorised series and shunt voltage regulated power supplies. Apart from series and shunt circuits, the current limiting and variable voltage techniques are also included. The board is absolutely self contained and requires no other apparatus.

Practical experience on this board carries great educative value for Science and Engineering Students.

Object:

01. To study a transistor-shunt voltage regulator with fixed current limiting.
02. To study a transistor-shunt variable regulator with fixed current limiting.
03. To study a transistor-shunt voltage regulator with variable current limiting.
04. To study a transistor-series variable voltage regulator.
05. To study a transistor-series voltage regulator.
06. To study a transistor-series voltage regulator with fixed current limiting.

Features:

The board consists of following built-in parts :

01. 12.5V D.C. \pm 10% at 50mA, unregulated Power Supply.
02. D.C. Voltmeter, 65mm rectangular dial to read 0-15V.
03. D.C. Milliammeter, 65mm rectangular dial to read 0-50mA.
04. Two NPN and one PNP medium current transistors.
05. Zener diode.
06. Two wire wound potentiometers and one carbon

potentiometer.

07. Adequate no. of other electronic components.
 08. Mains ON/OFF switch, Fuse and Jewel light.
- * The unit is operative on 230V \pm 10% at 50Hz A.C. Mains.
 - * Adequate no. of patch cords stackable from rear both ends 4mm spring loaded plug length ½ metre.
 - * Good Quality, reliable terminal/sockets are provided at appropriate places on panel for connections/observation of waveforms.
 - * Strongly supported by detailed Operating Instructions, giving details of Object, Theory, Design procedures, Report Suggestions and Book References.

Zener Regulated Power Supplies

Order Code - 36207



Experimental Training Board has been designed specifically for the study of regulated power supplies based on Zener Voltage regulating diodes.

A Zener diode is generally employed in a standard circuit as a voltage regulator. This training board deals with some more possible voltage regulating circuits apart from the standard one. The board is absolutely self contained and requires no other apparatus.

Practical experience on this board carries great educative value for Science and Engineering Students.

Object:

01. To study the standard zener diode voltage regulated power supply.
02. To study the zener diode voltage regulated supply having two zener diodes in series.
03. To study a dual polarity voltage regulated supply employing two zener diodes.
04. To study a zener diode voltage regulated supply employing a series pass transistor for increasing the output current capability of the circuit.

Features:

The board consists of following built-in parts :

01. \pm 12V5 \pm 10% at 50mA, unregulated D.C. Voltage.
 02. D.C. Voltmeter, 65mm rectangular dial to read 0-15V.
 03. DC Milliammeter, 65mm rectangular dial to read 0-50mA.
 04. NPN Transistor.
 05. Three zener diodes.
 06. Adequate no. of other electronic components.
 07. Mains ON/OFF switch, Fuse and Jewel light.
- * The unit is operative on 230V \pm 10% at 50Hz A.C. Mains.
 - * Adequate no. of patch cords stackable from rear both ends 4mm spring loaded plug length ½ metre.
 - * Good Quality, reliable terminal/sockets are provided at appropriate places on panel for connections/observation of waveforms.
 - * Strongly supported by detailed Operating Instructions, giving details of Object, Theory, Design procedures, Report Suggestions and Book References.

Study of a Transformer

Order Code - 36208



Experimental Training Board has been designed specifically for the study of a Transformer. Various measurements can be easily done on a transformer. The board is absolutely self contained and requires no other apparatus.

Practical experience on this board carries great educative value for Science and Engineering Students.

Object:

To Study transformer for the following :

01. Transformation Ratio.
02. Copper loss.
03. The efficiency of transformer.

Features:

The board consists of following built-in parts :

01. Mains transformer with primary 230V at 50Hz and secondary output 0-10VA.C. at 1 Amp.
 02. A.C./D.C. Voltmeter, 65mm round dial, for measuring the mains input to the transformer of 0-250V.
 03. A.C./D.C. Milliammeter, 65mm round dial, for measuring the primary circuit current of 0-100mA.
 04. A.C./D.C. Voltmeter, 65mm round dial, for measuring the secondary voltage of 0-15V.
 05. A.C./D.C. Ammeter, 65mm round dial, for measuring the secondary circuit current of 0-1 Amp.
 06. High Wattage rating potentiometer for transformer's primary voltage variations.
 07. High Wattage rating potentiometer to be used as a load for the secondary circuit.
 08. Adequate no. of other electronic components.
 09. Mains ON/OFF switch, Fuse and Jewel light.
- * The unit is operative on 230V \pm 10% at 50Hz A.C. Mains.
 - * Adequate no. of patch cords stackable from rear both ends 4mm spring loaded plug length 1/2 metre.
 - * Good Quality, reliable terminal/sockets are provided at appropriate places on panel for connections/ observation of waveforms.
 - * Strongly supported by detailed Operating Instructions, giving details of Object, Theory, Design procedures, Report Suggestions and Book References.

Study of L-R Circuit With a Source of Alternating Emf

Order Code - 36209



Experimental Training Board has been designed specifically for the study of L-R circuit with a source of alternating E.M.F. The board is absolutely self

contained and requires no other apparatus.

Practical experience on this board carries great educative value for Science and Engineering Students.

Object:

To study L-R circuit with a source of alternating E.M.F. and thus to determine :

01. The power factor, $\cos \phi$ of the inductive load.
02. The equivalent power loss resistance of the inductor.
03. The inductance of the inductor.
04. The phase difference between applied voltage and that across resistance.

Features:

The board consists of following built-in parts :

01. Mains transformer having secondary tappings at 20V, 30V, 40V, 50V & 60V at 500mA.
 02. Two A.C. Voltmeters, 65mm round dial to read 0-50V.
 03. A.C. Voltmeter, 65mm round dial to read 0-75V.
 04. A.C. Milliammeter, 65mm round dial to read 0-500mA.
 05. One inductor of which inductance & resistance has to be measured.
 06. One high wattage resistance.
 07. Mains ON/OFF switch, Fuse and Jewel light.
- * The unit is operative on 230V \pm 10% at 50Hz A.C. Mains.
 - * Adequate no. of patch cords stackable from rear both ends 4mm spring loaded plug length 1/2 metre.
 - * Good Quality, reliable terminal/sockets are provided at appropriate places on panel for connections/observation of waveforms.
 - * Strongly supported by detailed Operating Instructions, giving details of Object, Theory, Design procedures, Report Suggestions and Book References.
 - * Weight : 3 Kg. (Approx.)
 - * Dimension : W 340 x H 110 x D 210

Comparative Study of CE, CB And CC Amplifiers

Order Code - 36210



Experimental Training Board has been designed specifically for the Comparative study of Common Emitter (CE), Common Base (CB) and Common Collector (CC) Transistor Amplifiers. These practical transistor amplifier configurations are evaluated in respect of their main parameters and results are compared with theoretical calculations.

Practical experience on this board carries great educative value for Science and Engineering Students.

Object:

01. Study of Common Emitter (CE) transistor amplifier circuit and evaluation of its input & output resistance, voltage gain, current gain and power gain.
02. Study of Common Base (CB) transistor amplifier circuit and evaluation of its input and output resistance, voltage gain, current gain and power

gain.

03. Study of Common Collector (CC) transistor amplifier circuit and evaluation of its input and output resistance, voltage gain, current gain and power gain.

Features:

The board consists of following built-in parts :

01. $\pm 9V$ D.C. at 100mA, IC Regulated Power Supply internally connected.
02. All the three circuits i.e. CE, CB and CC are built separately.
03. Adequate no. of other electronic components.
04. Sine Wave Signal Generator of 1KHz, with variable level, low distortion, based on IC.
05. Mains ON/OFF switch, Fuse and Jewel light.
 - * The unit is operative on 230V $\pm 10\%$ at 50Hz A.C. Mains.
 - * Adequate no. of patch cords stackable from rear both ends 4mm spring loaded plug length $\frac{1}{2}$ metre.
 - * Good Quality, reliable terminal/sockets are provided at appropriate places on panel for connections/observation of waveforms.
 - * Strongly supported by detailed Operating Instructions, giving details of Object, Theory, Design procedures, Report Suggestions and Book References.

Study of Diode Clipping Circuits

Order Code - 36211



Experimental Training Board has been designed specifically to study eight different types of circuits for single level and two level clipping for an input sine wave signal.

Practical experience on this board carries great educative value for Science and Engineering Students.

Object:

To study diode clipping circuits.

01. Single level clipping circuits :
 - 1.1 Positive base clipping with diode in series.
 - 1.2 Positive base clipping with diode in shunt.
 - 1.3 Negative base clipping with diode in series.
 - 1.4 Negative base clipping with diode in shunt.
 - 1.5 Negative peak clipping.
 - 1.6 Positive peak clipping.
02. Two level clipping circuits :
 - 2.1 Two level clipping with diodes.
 - 2.2 Two level clipping with zener diodes.

Features:

The board consists of following built-in parts :

01. Two, 0-10V D.C. at 10mA, continuously variable Power Supplies.
02. 0-12V, A.C. 50Hz at 20mA, continuously variable Power Supply.
03. D.C. Voltmeter, 65mm rectangular dial to read 0-10V.
04. Two silicon diodes.
05. Two zener diodes.
06. Adequate no. of other electronic components.

07. Mains ON/OFF switch, Fuse and Jewel light.

- * The unit is operative on 230V $\pm 10\%$ at 50Hz A.C. Mains.
- * Adequate no. of patch cords stackable from rear both ends 4mm spring loaded plug length $\frac{1}{2}$ metre.
- * Good Quality, reliable terminal/sockets are provided at appropriate places on panel for connections/observation of waveforms.
- * Strongly supported by detailed Operating Instructions, giving details of Object, Theory, Design procedures, Report Suggestions and Book References.

Opto Electronic Devices Characteristics

Order Code - 36212



Experimental Training Board has been designed specifically to study the characteristics of Opto Electronic Devices. Different experiments have been included in this Opto Electronic Devices characteristics board in order that a wide range of topics on Opto Electronics Devices Characteristics be covered in a short span of time. All the circuits for obtaining the characteristics of various devices can be easily assembled on this versatile training board itself.

Practical experience on this board carries great educative value for Science and Engineering Students.

Object:

To study the characteristics of the following opto electronic devices :

01. Light Emitting Diode (LED).
02. Photo Diode.
03. Photo Transistor.
04. Light Dependent Resistor (L.D.R.).
05. Photo Voltaic Cell.
06. Optocoupler.

Features:

The board consists of the following built-in parts:

01. Two 0-10V D.C. at 100mA, continuously variable regulated Power Supplies.
02. Digital Voltmeter DC $3\frac{1}{2}$ Digit having Dual range of 2V / 20V.
03. Digital Current meter DC $3\frac{1}{2}$ Digit having Dual range of 2mA / 20mA
04. Digital Current meter DC $3\frac{1}{2}$ Digit having Dual range of 200mA / 20mA
05. Opto Electronic Devices:
 - Light Emitting Diode (LED)
 - Photo Diode
 - Photo Transistor
 - Light Dependent Resistance (LDR)
 - Photo Voltaic Cell
 - Opto Coupler
06. Adequate no. of other electronic components.
 - * The unit is operative on 230V $\pm 10\%$ at 50Hz A.C. Mains.
 - * Adequate no. of patch cords stackable from rear both ends 4mm spring loaded plug length $\frac{1}{2}$ metre.
 - * Good Quality, reliable terminal/sockets are provided at appropriate places on panel for

connections.

- * Strongly supported by detailed Operating Instructions, giving details of Object, Theory, Design procedures, Report Suggestions and Book References.

Study of Crystal Detector

Order Code - 36213



Experimental Training Board has been designed specifically to study the characteristics of a Crystal Detector. The board is absolutely self contained and requires no other apparatus.

Practical experience on this board carries great educative value for Science and Engineering Students.

Object:

Study of a Crystal Detector.

01. To study the variation of output current I and applied signal V . or
02. To study the effect of load resistance on efficiency of detection.
03. To study the effect of capacitance on efficiency of detection.

Features:

The board consists of the following built-in parts :

01. 0-9V A.C. at 10mA, continuously variable Power Supply.
 02. A.C./D.C. Voltmeter, 65 mm rectangular dial to read. 0-10V.
 03. D.C. Milliammeter, 65 mm rectangular dial to read. 0-1mA.
 04. One Crystal Detector.
 05. Adequate no. of other electronic components.
 06. Mains ON/OFF switch, Fuse and Jewel light.
- * The unit is operative on 230V \pm 10% at 50Hz A.C. Mains.
 - * Adequate no. of patch cords stackable from rear both ends 4mm spring loaded plug length $\frac{1}{2}$ metre.
 - * Good Quality, reliable terminal/sockets are provided at appropriate places on panel for connections/observation of waveforms.
 - * Strongly supported by detailed Operating Instructions, giving details of Object, Theory, Design procedures, Report Suggestions and Book References.

Study of Source Follower

Order Code - 36214



Experimental Training Board has been designed specifically for the study of Source Follower with different biasing arrangements.

Practical experience on this board carries great educative value for Science and Engineering Students.

Object:

To study Source Follower.

01. To measure voltage gain of the Source Follower.
02. To measure input impedance of the Source Follower.
03. To measure output impedance of the Source Follower.
04. To study the above parameters with different biasing arrangements.

Features:

The board consists of the following built-in parts:

01. +12V D.C. at 200mA, regulated Power Supply internally connected.
 02. Field Effect Transistor.
 03. Adequate no. of other electronic components.
 04. Mains ON/OFF switch, Fuse and Jewel light.
- * The unit is operative on 230V \pm 10% at 50Hz A.C. Mains.
 - * Adequate no. of patch cords stackable from rear both ends 4mm spring loaded plug length $\frac{1}{2}$ metre.
 - * Good Quality, reliable terminal/sockets are provided at appropriate places on panel for connections/observation of waveforms.
 - * Strongly supported by detailed Operating Instructions, giving details of Object, Theory, Design procedures, Report Suggestions and Book References.

Other Apparatus Required:

01. AC millivoltmeter
02. Decade resistance box
03. Sine Square Wave Generator
04. Cathode Ray Oscilloscope 20MHz

Verification of Kirchoff's Law (for D.C. Circuit)

Order Code - 36215



Experimental Training Board has been designed specifically to study & verify the Kirchoff's voltage & current law for D.C. circuit. The board is absolutely self contained and requires no other apparatus.

Practical experience on this board carries great educative value for Science and Engineering Students.

Object:

Verification of Kirchoff's laws for D.C. circuit .

01. To verify Kirchoff's current law.
02. To verify Kirchoff's voltage law.

Features:

The board consists of the following built-in parts :

01. 0-10V D.C. at 10mA, continuously variable regulated Power Supply.
 02. D.C. Voltmeter, 65 mm rectangular dial to read 0-10V.
 03. D.C. Milliammeter, 65 mm rectangular dial to read 0-10mA.
 04. Adequate no. of other electronic components.
 05. Mains ON/OFF switch, Fuse and Jewel light.
- * The unit is operative on 230V \pm 10% at 50Hz A.C. Mains.
 - * Adequate no. of patch cords stackable from rear both ends 4mm spring loaded plug length $\frac{1}{2}$

metre.

- * Good Quality, reliable terminal/sockets are provided at appropriate places on panel for connections/ observation of waveforms.
- * Strongly supported by detailed Operating Instructions, giving details of Object, Theory, Design procedures, Report Suggestions and Book References.

Determination of Impedance of R.C. Circuits at Different Frequencies

Order Code - 36216



Experimental Training Board has been designed specifically for the determination of impedance of R.C. Circuits at different frequencies. The impedance of the R.C. series combination can be determined at various audio frequencies.

Practical experience on this board carries great educative value for Science and Engineering Students.

Object:

To determine the impedance of a R.C. series combination at different frequencies.

Features:

The board consists of the following built-in parts:

01. A.F. Milliammeter, 65 mm rectangular dial with switch selectable ranges of 0-5 mA and 0-25mA.
02. A.F. Voltmeter, 65 mm rectangular dial with switch selectable ranges of 0-1V and 0-10V.
03. Adequate no. of other electronic components.
- * Adequate no. of patch cords stackable from rear both ends 4mm spring loaded plug length ½ metre.
- * Good Quality, reliable terminal/sockets are provided at appropriate places on panel for connections/observation of waveforms.
- * Strongly supported by detailed Operating Instructions, giving details of Object, Theory, Design procedures, Report Suggestions and Book References.

Other Apparatus Required

01. Audio Frequency Generator

Study of Audio Frequency Transformer

Order Code - 36217



Experimental Training Board has been designed specifically to study the characteristics of an Audio Frequency Transformer.

Practical experience on this board carries great educative value for Science and Engineering Students.

Object:

To study an Audio Frequency Transformer.

01. To measure the transformer ratio of an A.F. Transformer.

02. To find out the optimum value of load resistance to match with A.F. Transformer.
03. To plot transmission curve for A.F. Transformer.
04. To plot linearity curves for A.F. Transformer.

Features:

The board consists of the following built-in parts :

01. An Audio Frequency Transformer.
02. Decade Resistances, Two dials of 1 Ohm and 10 Ohms, Total 110 Ohms.
03. Adequate no. of other electronic components.
- * Adequate no. of patch cords stackable from rear both ends 4mm spring loaded plug length ½ metre.
- * Good Quality, reliable terminal/sockets are provided at appropriate places on panel for connections/observation of waveforms.
- * Strongly supported by detailed Operating Instructions, giving details of Object, Theory, Design procedures, Report Suggestions and Book References.
- * Weight : 3 Kg. (Approx.)
- * Dimension : W 340 x H 110 x D 210

Other Apparatus Required:

01. Audio frequency generator
02. A.C. Millivoltmeter

Study of Fourier Analysis

Order Code - 36218



Experimental Training Board has been designed specifically for the study of Fourier Analysis. In electronics, we deal with signals which are not simple Sine Waves. They are composed of a number of Frequencies and their description is quite complex. However, any complex signal may be represented as a sum of simple Sine or Cosine waves. The mathematical tool that helps us in this type of analysis is called the Fourier theorem. Practical experience on this board carries great educative value for Science and Engineering Students.

Object:

To Study of Fourier Analysis.

To determine the Fourier component of :

01. A square wave.
02. A clipped sine wave.

Features:

The board consists of the following built-in parts:

01. Inductor and Diode with binding posts.
02. SPDT switch for selecting modes.
03. Adequate no. of other electronic components.
- * Adequate no. of patch cords stackable from rear both ends 4mm spring loaded plug length ½ metre.
- * Good Quality, reliable terminal/sockets are provided at appropriate places on panel for connections/observation of waveforms.
- * Strongly supported by detailed Operating Instructions, giving details of Object, Theory, Design procedures, Report Suggestions and Book

References.

- * Weight : 3 Kg. (Approx.)
- * Dimension : W 340 x H 110 x D 210

Other Apparatus Required:

01. A.C. Millivoltmeter
02. Sine, Square wave Oscillator
03. Cathode Ray Oscilloscope 20MHz

Time Delay Relay

Order Code - 36219



Experimental Training Board has been designed specifically for the study of Time Delay Relay circuit. This training board can also be used as a time delay relay to control external loads. The board is absolutely self contained and requires no other apparatus. Practical experience on this board carries great educative value for Science and Engineering Students, specially in the industrial electronics.

Object:

01. To study the time delay relay circuit with controlling ON time.
02. To study the time delay relay circuit with controlling OFF time.

Features:

The board consists of the following built-in parts :

01. +12V D.C. at 100mA, IC regulated Power Supply internally connected.
02. Relay 12V D.C. having single pole, 2 way, to control ON time as well as OFF time, connected internally with circuit.
03. Provision for varying the delay time i.e. time can be set from 1 sec to 100 sec.
04. Trigger & Reset switches.
05. 15 W pigmy lamp to demonstrate the relay operation.
06. Circuit based on timer IC.
07. Adequate no. of other electronic components.
08. Mains ON/OFF switch, Fuse and Jewel light.
- * The unit is operative on 230V \pm 10% at 50Hz A.C. Mains.
- * Adequate no. of patch cords stackable from rear both ends 4mm spring loaded plug length ½ metre.
- * Good Quality, reliable terminal/sockets are provided at appropriate places on panel for connections/observation of waveforms.
- * Strongly supported by detailed Operating Instructions, giving details of Object, Theory, Design procedures, Report Suggestions and Book References.

Audio Amplifier (5W4 Ohms)

Order Code - 36220



Experimental Training Board has been designed specifically for the study of Audio Amplifier. Practical

experience on this board carries great educative value for Science and Engineering Students.

Object:

Study of the Audio Amplifier.

Features:

The board consists of the following built-in parts :

01. +9V D.C. at 100mA, IC regulated Power Supply internally connected.
02. Input & output transformers.
03. AF driver and output stage.
04. Speaker 4 ohms (5W).
05. Volume & tone control.
06. Adequate no. of other electronic components.
07. Mains ON/OFF switch, Fuse and Jewel light.
- * The unit is operative on 230V \pm 10% at 50Hz A.C. Mains.
- * Adequate no. of patch cords stackable from rear both ends 4mm spring loaded plug length ½ metre.
- * Good Quality, reliable terminal/sockets are provided at appropriate places on panel for connections/observation of waveforms.
- * Strongly supported by detailed Operating Instructions, giving details of Object, Theory, Design procedures, Report Suggestions and Book References.

Other Apparatus Required:

01. Audio Frequency Generator
02. Output Power Meter
03. A.C. Millivoltmeter

De-Sauty Bridge Applications

Order Code - 36221



Experimental Training Board has been designed specifically to study applications of De-Sauty Bridge. Practical experience on this board carries great educative value for Science and Engineering Students.

Object:

To study De-Sauty Bridge Applications.

01. Measurement of capacitance of gang condenser using De-Sauty Bridge.
02. Measurement of a dielectric constant of a non-conducting liquid using De-Sauty Bridge.

Features:

The board consists of the following built-in parts :

01. Two Nos. of Decade Resistors in steps of 100 Ohm, Total 1 K Ohm each.
02. Decade Condenser, in steps of 100 PF, Total 1000 PF.
03. A high impedance Head Phone for null detection.
04. Gang condenser.
- * Adequate no. of patch cords stackable from rear both ends 4mm spring loaded plug length ½ metre.
- * Good Quality, reliable terminal/sockets are provided at appropriate places on panel for connections/observation of waveforms.
- * Strongly supported by detailed Operating Instructions, giving details of Object, Theory,

Design procedures, Report Suggestions and Book References.

Other Apparatus Required:

01. Sine Square Wave Generator

Study of R.C. Transmission Line At 50Hz

Order Code - 36222



Experimental Training Board has been designed specifically for the study of R.C. Transmission Line at 50Hz. The variation in magnitude and phase of the voltage after every section can be studied for different input voltages at 50 Hz. One will observe the phase shift of almost 2p in 20 sections.

Practical experience on this board carries great educative value for Science and Engineering Students.

Object:

01. To study R-C Transmission Line at 50Hz.
02. To draw a curve, showing the variation of magnitude and phase of the Voltages along the R.C. ladder network and to find the Attenuation.

Features:

The board consists of the following built-in parts :

01. A.C step down transformer having secondary tappings at 50,100 and 200V at 200mA.
02. 20T sections of R & C brought out on sockets for connections.
03. Mains ON/OFF switch, Fuse and Jewel light.
 - * The unit is operative on 230V \pm 10% at 50Hz A.C. Mains.
 - * Adequate no. of patch cords stackable from rear both ends 4mm spring loaded plug length 1/2 metre.
 - * Good Quality, reliable terminal/sockets are provided at appropriate places on panel for connections/observation of waveforms.
 - * Strongly supported by detailed Operating Instructions, giving details of Object, Theory, Design procedures, Report Suggestions and Book References.

Other Apparatus Required:

01. Digital Multimeter 3 $\frac{3}{4}$ digit

Verification of Ohm's Law Series & Parallel Circuits

Order Code - 36223



Experimental Training Board has been designed specifically for the verification of Ohm's Law & to study the series and parallel combination of Resistance network. This training board is quite useful for imparting the basic knowledge of voltage and current distribution and the effect of series parallel circuit. The board is absolutely self contained and requires no other apparatus.

Practical experience on this board carries great educative value for Science and Engineering Students.

Object:

01. Verification of ohm's Law.
02. To study series circuits.
03. To study parallel circuits.

Features:

The board consists of the following built-in parts:

01. 0-15 VD.C. at 100 mA, continuously variable regulated Power Supply.
02. Digital Voltmeter DC 3 $\frac{1}{2}$ Digit range of 20V.
03. Digital Current meter DC 3 $\frac{1}{2}$ digit range of 200mA .
04. Adequate no. of other electronic components.
05. Mains ON/OFF switch, Fuse and Jewel light.
 - * The unit is operative on 230V \pm 10% at 50Hz A.C. Mains.
 - * Adequate no. of patch cords stackable from rear both ends 4mm spring loaded plug length 1/2 metre.
 - * Good Quality, reliable terminal/sockets are provided at appropriate places on panel for connections/observation of waveforms.
 - * Strongly supported by detailed Operating Instructions, giving details of Object, Theory, Design procedures, Report Suggestions and Book References.

Study of Direct Coupled Amplifier and Its Frequency Response

Order Code - 36224



Experimental Training Board has been designed specifically for the study of Direct Coupled Amplifier. Practical experience on this board carries great educative value for Science and Engineering Students.

Object:

01. To study the Measurement of Gain of the Two Stage Direct Coupled Amplifier.
02. To draw the Frequency response curve of Direct Coupled Amplifier.

Features:

The board consists of the following built-in parts:

01. +12V D.C. at 30 mA, IC regulated Power Supply internally connected.
02. Two Transistors for Amplifier construction.
03. Adequate no. of other electronic components.
04. Mains ON/OFF switch, Fuse and Jewel light.
 - * The unit is operative on 230V \pm 10% at 50Hz A.C. Mains.
 - * Adequate no. of patch cords stackable from rear both ends 4mm spring loaded plug length 1/2 metre.
 - * Good Quality, reliable terminal/sockets are provided at appropriate places on panel for connections/observation of waveforms.
 - * Strongly supported by detailed Operating Instructions, giving details of Object, Theory, Design procedures, Report Suggestions and Book References.

Other Apparatus Required:

- 01. Audio Frequency Generator
- 02. A.C. Millivoltmeter
- 03. Cathode Ray Oscilloscope 20MHz

Study of Complementary-Symmetry Transistor Power Amplifier

Order Code - 36225



Experimental Training Board has been designed specifically for the study of Complementary Symmetry Transistor Power Amplifier. This training board is quite useful for measuring D.C. bias current and observation of waveforms.

Practical experience on this board carries great educative value for Science and Engineering Students.

Object:

To study the complementary symmetry transistor power amplifier.

- 01. To measure the D.C. Voltage at certain test points with signal and without signal.
- 02. To measure the D.C. bias current (with and without signal) and also to measure the idling current.
- 03. To measure input and output impedances and power gain.

Features:

The board consists of the following built-in parts:

- 1. +9V D.C. at 100 mA, IC regulated Power Supply internally connected.
- 2. D.C. Milliammeter, 65 mm rectangular dial with switch selectable ranges of 5mA and 50mA.
- 3. Three Transistors for amplifier construction.
- 4. Adequate no. of other electronic components.
- 5. Mains ON/OFF switch, Fuse and Jewel light.
- * The unit is operative on 230V ±10% at 50Hz A.C. Mains.
- * Adequate no. of patch cords stackable from rear both ends 4mm spring loaded plug length ½ metre.
- * Good Quality, reliable terminal/sockets are provided at appropriate places on panel for connections/observation of waveforms.
- * Strongly supported by detailed Operating Instructions, giving details of Object, Theory, Design procedures, Report Suggestions and Book References.

Other Apparatus Required:

- 01. Decade Audio Frequency Generator
- 02. A.C. Millivoltmeter
- 03. A.F. Output Power Meter
- 04. Decade Resistance Box
- 05. Digital Multimeter 3¾ digit
- 06. Cathode Ray Oscilloscope 20MHz

Power & Power Factor In Series LCR Circuits Using Single Phase

Order Code - 36226



Experimental Training Board has been designed specifically to determine the Power and Power Factor in Series RLC circuit using Single Phase A.C. Supply. The board is absolutely self contained and requires no other apparatus.

Practical experience on this board carries great educative value for Science and Engineering Students.

Object:

Determination of Power and Power Factor in series RLC circuit using Single Phase.

- 01. Study of Series RLC Circuit using Single Phase A.C. and to determine
 - (a) Power
 - (b) Power Factor and also draw the vector diagram.
- 02. Study of Series R-L Circuit using Single Phase A.C. and to determine
 - (a) Power
 - (b) Power Factor and also draw the vector diagram.
- 03. Study of Series R-C Circuit using Single Phase A.C. and to determine
 - (a) Power
 - (b) Power Factor and also draw the vector diagram.

Features:

The board consists of the following built-in parts:

- 01. Mains transformer having Secondary tappings at 20V, 30V, 40V, 50V and 60VA.C. at 500mA
- 02. Two A.C. Voltmeters, 65 mm round dial to read 0-75V.
- 03. A.C. Voltmeter, 65 mm round dial to read 0-50V.
- 04. A.C. Milliammeter, 65 mm round dial to read 0-500mA.
- 05. High wattage resistance, capacitor and inductor.
- 06. Mains ON/OFF switch, Fuse and Jewel light.
- * The unit is operative on 230V ±10% at 50Hz A.C. Mains.
- * Adequate no. of patch cords stackable from rear both ends 4mm spring loaded plug length ½ metre.
- * Good Quality, reliable terminal/sockets are provided at appropriate places on panel for connections/observation of waveforms.
- * Strongly supported by detailed Operating Instructions, giving details of Object, Theory, Design procedures, Report Suggestions and Book References.

Measurement of Temperature Co-efficient of Resistance

Order Code - 36227



Experimental Training Board has been designed specifically for the measurement of temperature coefficient of resistance. With the help of this Training Board one can familiarize the variation of resistance with temperature. The board is absolutely self contained and requires no other apparatus. Practical experience on this board carries great educative value for Science and Engineering Students.

Object:

01. Measurement of positive Temperature Co-efficient of resistance.
02. Measurement of negative Temperature Co-efficient of resistance.

Features:

The board consists of the following built-in parts:

01. 0-20V D.C. at 100mA, continuously variable regulated Power Supply
 02. D.C. Voltmeter, 65mm rectangular dial having switch selectable ranges of 2V and 20V.
 03. D.C. Ammeter, 65mm rectangular dial having switch selectable ranges of 5mA and 50mA.
 04. Oven, electrically heated, with clamp for thermometer.
 05. Two thermistors, one NTC type and another PTC type with leads.
 06. Adequate no. of other electronic components.
 07. Mains ON/OFF switch, Fuse and Jewel light.
- * The unit is operative on 230V $\pm 10\%$ at 50Hz A.C. Mains.
 - * Adequate no. of patch cords stackable from rear both ends 4mm spring loaded plug length $\frac{1}{2}$ metre.
 - * Good Quality, reliable terminal/sockets are provided at appropriate places on panel for connections/ observation of waveforms.
 - * Strongly supported by detailed Operating Instructions, giving details of Object, Theory, Design procedures, Report Suggestions and Book References.

Study of R.C. Circuits With Varying EMF

Order Code - 36228



Experimental Training Board has been designed specifically for the study of RC Circuit with varying EMF. Practical experience on this board carries great educative value for Science and Engineering Students.

Object:

To study RC Circuit with varying EMF.

01. To study the charging of a capacitor with pulses of width greater than the time constant of the circuit.
02. To study the charging with rectangular pulses of width much less than the time constant of the circuit.
03. To study the charging with short rectangular pulses of equal and unequal widths ($t \ll RC$).
04. To repeat experiment 1, 2 & 3 with pulses of different shapes.
05. To study an RC Circuit with a diode as an integrating system.

06. To study an integrating RC Circuit with alternating input.
07. To study the integrating system with a sinusoidal input.

Features:

The board consists of the following built-in parts:

01. Mains transformer having secondary tapings at 20V and 40VA.C. at 100mA.
 02. Digital Panel Meter having D.C. voltage ranges 0-20V and 0-200 Volts.
 03. A toroidal rheostat 500 ohms, 10W.
 04. Diode, switch and adequate no. of other electronic components.
 05. Mains ON/OFF switch and fuse.
- * The unit is operative on 230V $\pm 10\%$ at 50Hz A.C. Mains.
 - * Adequate no. of patch cords stackable 4mm spring loaded plug length $\frac{1}{2}$ meter.
 - * Good Quality, reliable terminal/sockets are provided at appropriate places on panel for connections/observation of waveforms.

Other Apparatus Required:

01. Variable Power Supply

Study of R-C Circuits With A Source of Alternating E.M.F.

Order Code - 36229



Experimental Training Board has been designed specifically for the study of R-C Circuit with a Source of Alternating E.M.F. The board is absolutely self contained and requires no other apparatus. Practical experience on this board carries great educative value for Science and Engineering Students.

Object:

To study a R-C Circuit with a source of alternating E.M.F.

01. To study of R-C Circuit using A.C. mains.
02. To measure the impedance of a R-C Circuit.

Features:

The board consists of the following built-in parts:

01. Mains transformer having secondary tapings at 20V, 50V and 100VA.C. at 50mA.
 02. Digital A.C. Voltmeter of 200V range
 03. Digital A.C. Milliammeter of dual range 20mA & 200mA.
 04. Adequate no. of other electronic components.
 05. Mains ON/OFF switch, Fuse and Jewel light.
- * The unit is operative on 230V $\pm 10\%$ at 50Hz A.C. Mains.
 - * Adequate no. of patch cords stackable from rear both ends 4mm spring loaded plug length $\frac{1}{2}$ metre.
 - * Good Quality, reliable terminal/sockets are provided at appropriate places on panel for connections/observation of waveforms.
 - * Strongly supported by detailed Operating Instructions, giving details of Object, Theory, Design procedures, Report Suggestions and Book References.

Measurement of Inductance & Capacitance by Maxwell's L/C Bridge

Order Code - 36230



Experimental Training Board has been designed specifically for the study of Maxwell's L/C Bridge. Using this bridge the value of unknown capacitor or an unknown inductor can be found. The board is absolutely self contained and requires no other apparatus. Practical experience on this board carries great educative value for Science and Engineering Students.

Object:

To study Maxwell's L/C Bridge.

01. To measure value of unknown capacitance.
02. To measure value of unknown Inductance.

Features:

The board consists of the following built-in parts:

01. $\pm 12V$ D.C. at 100mA, IC regulated Power Supply internally connected.
02. 1 KHz Sine Wave Oscillator.
03. Audio Amplifier and speaker for null detection.
04. Five unknown values of capacitors selectable by a band switch.
05. Three unknown values of inductors selectable by a band switch.
06. Two decade resistances in 100 ohm steps.
07. Potentiometer and adequate no. of other electronic components.
08. Mains ON/OFF switch, Fuse and Jewel light.
- * The unit is operative on $230V \pm 10\%$ at 50Hz A.C. Mains.
- * Adequate no. of patch cords stackable from rear both ends 4mm spring loaded plug length $\frac{1}{2}$ metre.
- * Good Quality, reliable terminal/sockets are provided at appropriate places on panel for connections/observation of wave forms.
- * Strongly supported by detailed Operating Instructions, giving details of Object, Theory, Design procedures, Report Suggestions and Book References.

Measurement of Capacitance by Wien Bridge

Order Code - 36231



Experimental Training Board has been designed specifically for the study of Wien Bridge and by which one can evaluate the unknown value of capacitance. Practical experience on this board carries great educative value for Science and Engineering Students.

Object:

To study Wien Bridge.

01. To measure the capacitance by Wien Series Bridge.
02. To measure the capacitance by Wien Parallel Bridge.

Features:

The board consists of the following built-in parts:

01. $\pm 12V$ D.C. at 100mA, IC regulated Power Supply internally connected.
02. 1 KHz Sine Wave Oscillator.
03. Audio Amplifier and speaker for null detection.
04. Three decade resistances, single dial in steps of 100 Ohm, Total 1K each, to form arms of a bridge.
05. Decade resistance, Two dials of 10 Ohm & 100 Ohm, total 1100 Ohms to form arms of bridge.
06. Decade Standard Capacitances, selectable by a band switch to form the one arm of the bridge.
07. Unknown capacitor and adequate no. of other electronic components.
08. Mains ON/OFF switch, Fuse and Jewel light.
- * The unit is operative on $230V \pm 10\%$ at 50Hz A.C. Mains.
- * Adequate no. of patch cords stackable from rear both ends 4mm spring loaded plug length $\frac{1}{2}$ metre.
- * Good Quality, reliable terminal/sockets are provided at appropriate places on panel for connections/observation of waveforms.
- * Strongly supported by detailed Operating Instructions, giving details of Object, Theory, Design procedures, Report Suggestions and Book References.

To Study The Behaviour of Light Emitting Diodes

Order Code - 36232



Experimental Training Board has been designed specifically for the study of Light Emitting Diodes (LED's). The application of an LED as a seven segment display is experimentally explained. The board is absolutely self contained and requires no other apparatus.

Practical experience on this board carries great educative value for Science and Engineering Students.

Object:

01. To understand the operation of an LED :
 - (a) On D.C. Voltage
 - (b) On A.C. Voltage
02. To plot and study the forward voltage current characteristics of different colour discrete LEDs.
03. To practically understand the operation of a seven segment LED display.

Features:

The board consists of following built-in parts :

01. +9V D.C. at 100mA, IC regulated Power Supply.
02. 12V A.C. at 100mA, Power Supply.
03. Digital Voltmeter DC $3\frac{1}{2}$ Digit range of 2V.
04. Digital Current meter DC $3\frac{1}{2}$ Digit having Dual of 20/200mA
05. Red, Green, Yellow and Bicolour discrete LEDs.
06. Seven segment common anode LED display.
07. Wire wound potentiometer and adequate no. of other electronic components.
08. Mains ON/OFF switch, Fuse and Jewel light.
- * The unit is operative on $230V \pm 10\%$ at 50Hz A.C. Mains.

- * Adequate no. of patch cords stackable from rear both ends 4mm spring loaded plug length ½ metre.
- * Good Quality, reliable terminal/sockets are provided at appropriate places on panel for connections/observation of waveforms.
- * Strongly supported by detailed Operating Instructions, giving details of Object, Theory, Design procedures, Report Suggestions and Book References.

Study of Darlington Pair Amplifier

Order Code - 36233



Experimental Training Board has been designed specifically for the study of Darlington Pair Amplifier. Practical experience on this board carries great educative value for Science and Engineering Students.

Object:

01. To experimentally calculate and compare the following circuits :
 - (i) Emitter Follower Circuit
 - (ii) Darlington pair Amplifier for the following parameters :
 - (a) Input Impedance
 - (b) Output Impedance
 - (c) Current gain
 - (d) Voltage gain
02. To understand the technique of Boot-Strapping and experimentally demonstrate its effect on input impedance of Darlington Pair Amplifier.

Features:

- The board consists of the following built-in parts :
01. +24V D.C. at 600mA, IC regulated Power Supply internally connected.
 02. Transistors, fitted on adequate heat sinks.
 03. Adequate no. of other electronic components.
 04. Mains ON/OFF switch, Fuse and Jewel light.
- * The unit is operative on 230V \pm 10% at 50Hz A.C. Mains.
 - * Adequate no. of patch cords stackable from rear both ends 4mm spring loaded plug length ½ metre.
 - * Good Quality, reliable terminal/sockets are provided at appropriate places on panel for connections/observation of waveforms.
 - * Strongly supported by detailed Operating Instructions, giving details of Object, Theory, Design procedures, Report Suggestions and Book References.

Study of Blocking Oscillator

Order Code - 36234



Experimental Training Board has been designed

specifically for the study of Blocking Oscillator. Practical experience on this board carries great educative value for Science and Engineering Students.

Object:

01. To observe on a C.R.O. the waveforms at the base and collector of an Astable Blocking Oscillator :
 - (a) Without connecting the diode
 - (b) After connecting the diode
02. To measure the pulse width and the frequency of the pulse-train with various combinations of C and R values.

Features:

The board consists of following built-in parts :

01. +9V D.C. at 100mA, IC regulated Power Supply internally connected.
 02. NPN transistor.
 03. Adequate no. of other electronic components.
 04. Mains ON/OFF switch, Fuse and Jewel light.
- * The unit is operative on 230V \pm 10% at 50Hz A.C. Mains.
 - * Adequate no. of patch cords stackable from rear both ends 4mm spring loaded plug length ½ metre.
 - * Good Quality, reliable terminal/sockets are provided at appropriate places on panel for connections/observation of waveforms.
 - * Strongly supported by detailed Operating Instructions, giving details of Object, Theory, Design procedures, Report Suggestions and Book References.

Other Apparatus Required:

01. Cathode Ray Oscilloscope 20MHz

Study of High Frequency Amplifier

Order Code - 36235

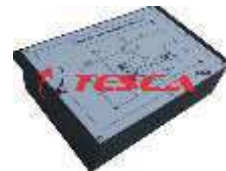

Experimental Training Board has been designed for the study of High Frequency Amplifier. Practical experience on this board carries great educative value for Science and Engineering Students.

Object:

01. To study the frequency response, bandwidth and voltage gain of high frequency amplifier.
02. To observe the effect of negative feedback on bandwidth and voltage gain of high frequency amplifier.

Features:

01. +12V D.C. at 50mA, IC regulated Power Supply internally connected.
 02. NPN transistor
 03. Three SPDT switches and adequate no. of other electronic components.
 04. Mains ON/OFF switch, Fuse and Jewel light.
- * The unit is operative on 230V \pm 10% at 50Hz A.C. Mains.
 - * Adequate no. of patch cords stackable from rear both ends 4mm spring loaded plug length ½ metre.

- * Good Quality, reliable terminal/sockets are provided at appropriate places on panel for connections/ observation of waveforms.
- * Strongly supported by detailed Operating Instructions, giving details of Object, Theory, Design procedures, Report Suggestions and Book References.

Other Apparatus Required:

- * AF/RF Generator
- * Cathode Ray Oscilloscope 20MHz

Study of Multivibrators (BMV, AMV and MMV Using IC-555)

Order Code - 36236



Experimental Training Board has been designed specifically for the study of Bistable, Astable and Monostable Multivibrators using IC 555. Practical experience on this board carries great educative value for Science and Engineering Students.

Object:

- Study of Multivibrators (BMV, AMV & MMV) using IC 555.
01. To study Bistable Multivibrator using IC 555.
 02. To study Astable Multivibrator using IC 555.
 03. To study Monostable Multivibrator using IC 555.

Features:

- The board consists of the following built-in parts :
01. +10V D.C. at 100mA, IC Regulated Power Supply internally connected.
 02. 1 KHz Square Wave Generator.
 03. IC 555.
 04. Adequate no of other electronic components.
 05. Mains ON/OFF switch, Fuse and Jewel light.
- * The unit is operative on 230V $\pm 10\%$ at 50Hz A.C. Mains.
 - * Adequate no. of patch cords stackable from rear both ends 4mm spring loaded plug length $\frac{1}{2}$ metre.
 - * Good Quality, reliable terminal/sockets are provided at appropriate places on panel for connections / observation of waveforms.
 - * Strongly supported by detailed Operating Instructions, giving details of Object, Theory, Design procedures, Report Suggestions and Book References.

Study of Null Balancing Techniques of Op-Amp

Order Code - 36237



Experimental Training Board has been designed specifically for the study of Null Balancing Techniques of OPAMPS. Practical experience on this board carries great educative value for Science and Engineering Students.

Object:

Study of Null Balancing Techniques of Operational Amplifiers.

01. INTERNAL OFF SET NULLING
 - For Inverting OP-AMP Circuit.
 - For Non-Inverting OP-AMP Circuit.
 - For Voltage follower Circuit.
02. UNIVERSAL EXTERNAL OFF SET NULLING
 - Inverting Amplifier, offset voltage applied to the Inverting input.
 - Inverting Amplifier, offset voltage applied to the Non-Inverting input.
 - Off setting circuit for low gain non-inverting OP-AMP.
 - Off setting circuit for high gain non-inverting OP-AMP.
 - Off setting circuit for voltage follower.
03. OTHER TYPES OF OFF SETARRANGEMENTS
 - Zero off setting.
 - Zero off setting buffer.

Features:

- The board consists of the following built-in parts :
01. $\pm 15V$ D.C at 100mA IC Regulated Power Supply internally connected.
 02. Two OP-AMPS.
 03. Linear potentiometer for the construction of offset nulling circuits.
 04. Adequate no. of other electronic components.
 05. Mains ON/OFF switch, Fuse and Jewel light.
- * The unit is operative on 230V $\pm 10\%$ at 50Hz A.C. Mains.
 - * Adequate no. of patch cords stackable from rear both ends 4mm spring loaded plug length $\frac{1}{2}$ meter.
 - * Good Quality, reliable terminal/sockets are provided at appropriate places on panel for connections / observation of waveforms.
 - * Strongly supported by detailed Operating Instructions, giving details of Object, Theory, Design procedures, Report Suggestions and Book References.

Other Apparatus Required:

01. Digital Multimeter $3\frac{1}{2}$ Digit
02. Cathode Ray Oscilloscope 15MHz

Study of Miller Sweep Circuit

Order Code - 36238



Experimental Training Board has been designed specifically for the study of Miller Sweep Circuit. Practical experience on this board carries great educative value for Science and Engineering Students.

Object:

01. To get familiar with the Miller Sweep Circuit and experimentally observe the effect of C and R value on the sweep waveform.
02. To experimentally observe the effect of the frequency of input step waveform on the sweep waveform.
03. To observe the linearity of the sweep waveform.

Features:

The board consists of the following built-in parts :

01. $\pm 12V$ DC at 50mA, IC Regulated Power Supply internally connected.
 02. IC based Square wave generator with switch selectable spot frequencies of 100Hz, 500Hz and 1KHz.
 03. OP-AMP's for Miller Sweep Circuit.
 04. Four band switches for selection of various resistors and capacitors.
 05. Mains ON/OFF switch, Fuse and Jewel light.
- * The unit is operative on 230V $\pm 10\%$ at 50Hz A.C. Mains.
 - * Adequate no. of patch cords stackable from rear both ends 4mm spring loaded plug length $\frac{1}{2}$ metre.
 - * Good Quality, reliable terminal/sockets are provided at appropriate places on panel for connections / observation of waveforms.
 - * Strongly supported by detailed Operating Instructions, giving details of Object, Theory, Design procedures, Report Suggestions and Book References.

Other Apparatus Required:

01. Cathode Ray Oscilloscope 20MHz

Study of RC Circuits With an Ultra Low Frequency AC Source

Order Code - 36239



Experimental Training Board has been specifically designed for the study of RC Circuits with an Ultra Low Frequency AC Source.

Practical experience on this board carries great educative value for Science and Engineering Students.

Object:

01. To make a preliminary study of voltage and phase relationship in a simple RC circuit.
02. To study the voltages in a pure resistive, capacitive and a mixed circuit.
03. To determine the phase difference between V and V in a RC circuit. R C
04. To study the phase difference between V and V by measuring the peak voltage values. R C
05. To study the phase relationship of currents in different parts of a RC circuit.
06. To study the behaviour of a RC circuit at different frequencies.

Features:

The board consists of the following built-in parts :

01. Two 0-12V D.C. at 50mA, continuously variable regulated Power Supplies.
02. Three Centre zero D.C. meters, 65mm rectangular dial to read 0.1mA, 0.5 mA and 2.5 mA or 1V, 5V and 10V with current or voltage mode selected with the help of switches.
03. Bridge rectifier.
04. Two SPST switches.
05. Adequate no. of other electronic components.
06. Mains ON/OFF switch, Fuse and Jewel light.

- * The unit is operative on 230V $\pm 10\%$ at 50Hz A.C. Mains.
- * Adequate no. of patch cords stackable from rear both ends 4mm spring loaded plug length $\frac{1}{2}$ metre.
- * Good Quality, reliable terminal/sockets are provided at appropriate places on panel for connections / observation of waveforms.
- * Strongly supported by detailed Operating Instructions, giving details of Object, Theory, Design procedures, Report Suggestions and Book References.

Other Apparatus Required:

01. Ultra Low Frequency Oscillator

Measurement of Temperature With Thermistor

Order Code - 36240



Experimental Training Board has been designed specifically for understanding the Temperature Measurement technique using a Thermistor. The board is absolutely self contained and requires no other apparatus.

Practical experience on this board carries great educative value for Science and Engineering Students.

Object:

01. To calibrate the ammeter for temperature measurement using in-built electrical oven and a Mercury thermometer.
02. To measure temperature of a hot object.

Features:

The board consists of the following built-in parts :

01. +12V D.C. at 50mA, IC regulated Power Supply internally connected.
 02. 20V A.C. at 1.2A, for oven.
 03. D.C. Microammeter, 65mm rectangular dial with switch selectable ranges of 500 mA and 1mA.
 04. Potentiometer and three fixed value resistors.
 05. NTC type 1K thermistor provided as a probe.
 06. Electrically heated oven.
 07. Glass thermometer.
 08. Mains ON/OFF switch, Fuse and Jewel light.
- * The unit is operative on 230V $\pm 10\%$ at 50Hz A.C. Mains.
 - * Adequate no. of patch cords stackable from rear both ends 4mm spring loaded plug length $\frac{1}{2}$ metre.
 - * Good Quality, reliable terminal/sockets are provided at appropriate places on panel for connections/observation of waveforms.
 - * Strongly supported by detailed Operating Instructions, giving details of Object, Theory, Design procedures, Report Suggestions and Book References.

Study of LCR Circuits With an AC Source Having Power Amplifier

Order Code - 36241



Experimental Training Board has been designed specifically to study LCR Circuits with an A.C. Source. The board is absolutely self contained and requires no other apparatus.

Practical experience on this board carries great educative value for Science and Engineering Students.

Object:

01. To determine the equivalent power loss resistance of an inductor.
02. To analyse a complex LR circuit by drawing vector diagrams.
03. To analyse a complex RC circuit.
04. To study a circuit with two inductors in series.
05. To study a circuit with two capacitors in series.
06. To study if V and V are always in the opposite phase. LC
07. To study the impedance of an LCR circuit.
08. To study the phase relationship in a series LCR circuit.
09. To study the Q of a series LCR resonant circuit.

Features:

The board consists of the following built-in parts :

01. Transformer having secondary tappings of 10V, 20V, 30V, 40V, 50V and 100VA.C. at 100mA.
02. Digital AC Voltmeter 3½ Digit Dual range 20V/200V to read AC Voltages
03. Adequate no. of other electronic components.
04. Mains ON/OFF switch, Fuse and Jewel light.
- * The unit is operative on 230V ±10% at 50Hz A.C. Mains.
- * Adequate no. of patch cords stackable from rear both ends 4mm spring loaded plug length ½ metre.
- * Good Quality, reliable terminal/sockets are provided at appropriate places on panel for connections / observation of waveforms.
- * Strongly supported by detailed Operating Instructions, giving details of Object, Theory, Design procedures, Report Suggestions and Book References.

Study of Cascode Amplifier

Order Code - 36242

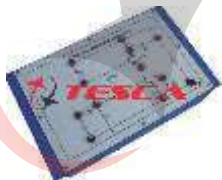

Experimental Training Board has been designed specifically for the study of Cascode Amplifier. Various parameters of a Cascode Amplifier can be measured on this training board.

Practical experience on this board carries great educative value for Science and Engineering Students.

Object:

To study Cascode Amplifier or CE-CB configuration for AC analysis and to determine the following parameters:

01. The input resistance

02. The output resistance
03. The overall voltage gain
04. The overall current gain

Features:

The board consists of the following built-in parts:

01. +12 V DC at 50 mA, IC Regulated Power Supply internally connected.
02. Two NPN transistors.
03. Adequate no. of other electronic components
04. Mains ON/OFF switch, Fuse and Jewel light.
- * The unit is operative on 230V ±10% at 50Hz A.C. Mains.
- * Adequate no. of patch cords stackable from rear both ends 4mm spring loaded plug length ½ metre.
- * Good Quality, reliable terminal/sockets are provided at appropriate places on panel for connections / observation of waveforms.
- * Strongly supported by detailed Operating Instructions, giving details of Object, Theory, Design procedures, Report Suggestions and Book References.

Study of Temperature On-off Controller With Thermistor

Order Code - 36243



Experimental Training Board has been designed specifically to study the principle of Temperature Control with the use of a Thermistor. This is one of the important industrial applications of the thermistor. The board is absolutely self contained and requires no other apparatus.

Practical experience on this board carries great educative value for Science and Engineering Students.

Object:

01. To turn ON or OFF an external load at a particular temperature.
02. To control and maintain the temperature of the internal oven.

Features:

The board consists of the following built-in parts :

01. ± 12V DC at 100 mA, IC Regulated Power Supply Internally connected.
02. 20VAC at 1 A for the internal oven.
03. 12V D.C. relay having contact rating of 2A.
04. Electrically heated Oven.
05. Op-Amp IC741.
06. NPN transistor.
07. Mercury thermometer.
08. NTC thermistor.
09. Potentiometer.
10. Rotary Switch and adequate no. of other electronic components.
11. Mains ON/OFF switch, Fuse and Jewel light.
- * The unit is operative on 230V ±10% at 50Hz A.C. Mains.
- * Adequate no. of patch cords stackable from rear both ends 4mm spring loaded plug length ½ metre.

- * Good Quality, reliable terminal/sockets are provided at appropriate places on panel for connections / observation of waveforms.
- * Strongly supported by detailed Operating Instructions, giving details of Object, Theory, Design procedures, Report Suggestions and Book References.

Measurement of Power & Power Factor of L-R Circuits

Order Code - 36244



Experimental Training Board has been designed specifically for the Measurement of Power and Power Factor of R-L Circuit with a single phase of AC voltage source using voltmeters, current meter and a wattmeter.

Practical experience on this board carries great educative value for Science and Engineering Students.

Object:

Measurement of Power and Power factor of R-L circuit with a single phase of AC voltage source using voltmeters, current meters and wattmeter.

Features:

The board consists of the following built-in parts:

01. Mains transformer having tappings at 10V, 20V, 30V and 40V $\pm 10\%$ AC at 500mA provided on terminals.
 02. A.C. Ammeter, 65mm round dial to read 0-500mA.
 03. Three A.C. Voltmeters, 65mm round dial to read 0-50VA.C.
 04. Wire wound resistor 100W, 20W.
 05. Inductor 200mH at 500mA rated current.
 06. Mains ON/OFF switch, Fuse and Jewel light.
- * The unit is operative on 230V $\pm 10\%$ at 50Hz A.C. Mains.
 - * Adequate no. of patch cords stackable from rear both ends 4mm spring loaded plug length $\frac{1}{2}$ metre.
 - * Good Quality, reliable terminal/sockets are provided at appropriate places on panel for connections / observation of waveforms.
 - * Strongly supported by detailed Operating Instructions, giving details of Object, Theory, Design procedures, Report Suggestions and Book References.

Study of Op-amp Comparator

Order Code - 36245



Experimental Training Board has been designed specifically for the study of OP-AMP Cooperator.

Practical experience on this board carries great educative value for Science and Engineering Students.

Object:

01. Study of OP-AMP Cooperator and its

Characteristics :

- (a) Non-Inverting Cooperator.
 - (b) Inverting Cooperator.
 - (c) Fast Precision Voltage Comparator.
 - (d) Comparator for signals of opposite polarity.
 - (e) Single ended comparator with Hysteresis and clamped feedback.
 - (f) Comparator for A.C. Coupled signals.
02. Applications of Comparator :
 - (a) Zero Crossing Detector.
 - (b) Schmit Trigger.
 - (c) Voltage Limiter.

Features:

The board consists of the following built-in parts :

01. $\pm 15V$ D.C. at 50mA, IC Regulated Power Supply.
 02. +5V DC at 50mA, IC Regulated Power Supply.
 03. 0-5V D.C. at 100mA, continuously variable Power Supply.
 04. Two OP-AMP ICs 741.
 05. Linear Potentiometer and adequate no. of other electronic components.
 06. Mains ON/OFF switch, Fuse and Jewel light.
- * The unit is operative on 230V $\pm 10\%$ at 50Hz A.C. Mains.
 - * Adequate no. of patch cords stackable from rear both ends 4mm spring loaded plug length $\frac{1}{2}$ metre.
 - * Good Quality, reliable terminal/sockets are provided at appropriate places on panel for connections / observation of waveforms.
 - * Strongly supported by detailed Operating Instructions, giving details of Object, Theory, Design procedures, Report Suggestions and Book References.

Study of Op-amp Mathematical Operations

Order Code - 36246



Experimental Training Board has been designed specifically for the study of OP-AMP and to carry out its Mathematical Operations. This Training Board has been an ideal teaching aid for different types of Electronic Circuits by using OP-AMP.

Practical experience on this board carries great educative value for Science and Engineering Students.

Object:

01. Study of Operational Amplifier in the following modes:
 - (a) Inverting Amplifier.
 - (b) Non-inverting Amplifier.
 - (c) Frequency Response of Inverting A.C. Amplifier.
 - (d) Frequency Response of Non-inverting A.C. Amplifier.
 - (e) High Input Impedance Inverting Amplifier.
 - (f) High Input Impedance Non-inverting Amplifier.
02. To study the following Mathematical Operations :
 - (a) Inverting Summing Amplifier.
 - (b) Non-inverting Summing Amplifier.
 - (c) Subtractor & Differential Amplifier.
 - (d) A.C. Differential Amplifier.
 - (e) Adder Subtractor.
 - (f) Multiplication by a Constant.

- (g) Division by a Constant.
- (h) Integrating Amplifier for D.C. Input Signals.
- (i) Integrating Amplifier for A.C. Input Signals.
- (j) Differentiator Amplifier.
- (k) Non-Inverting Differentiator.

Features:

The board consists of the following built-in parts :

01. $\pm 15V$ D.C. at 50mA, IC Regulated Power Supply.
 02. Three 0-2V D.C at 100mA, continuously variable regulated Power Supplies.
 03. OP-AMP IC741.
 04. Two SPST switches and adequate no. of other electronic components.
 05. Mains ON/OFF switch, Fuse and Jewel light.
- * The unit is operative on 230V $\pm 10\%$ at 50Hz A.C. Mains.
 - * Adequate no. of patch cords stackable from rear both ends 4mm spring loaded plug length $\frac{1}{2}$ metre.
 - * Good Quality, reliable terminal/sockets are provided at appropriate places on panel for connections/ observation of waveforms.
 - * Strongly supported by detailed Operating Instructions, giving details of Object, Theory, Design procedures, Report Suggestions and Book References.

Op-Amp Applications

Order Code - 36247



Experimental Training Board has been designed specifically for the study of different OP-AMP applications.

Practical experience on this board carries great educative value for Science and Engineering Students.

Object:

To study the following OP-AMP applications:

01. Square Wave generator.
02. Pulse & Ramp generator.
03. Triangular Generator.
04. Sine Wave Generator using Wien Bridge, Phase Shift Network.
05. Active Filters :
 - Low Pass Filter.
 - High Pass Filter.
 - Band Pass Filter.
 - Notch Filter.
06. Voltage Regulators.
07. Null Detector.
08. D.C. Microammeter.

Features:

The board consists of the following built-in parts

01. $\pm 15V$ D.C at 25mA, IC Regulated Power Supply.
02. 0-20V D.C at 100mA, continuously variable Power Supply.
03. D.C. Milliammeter, 65mm rectangular dial to read 0-1mA.
04. Two OP-AMP IC's 741.
05. Three Linear Potentiometers.
06. Two Zener Diodes and adequate no. of other electronic components

07. Mains ON/OFF switch, Fuse and Jewel light.

- * The unit is operative on 230V $\pm 10\%$ at 50Hz A.C. Mains.
- * Adequate no. of patch cords stackable from rear both ends 4mm spring loaded plug length $\frac{1}{2}$ metre.
- * Good Quality, reliable terminal/sockets are provided at appropriate places on panel for connections / observation of waveforms.
- * Strongly supported by detailed Operating Instructions, giving details of Object, Theory, Design procedures, Report Suggestions and Book References.

Other Apparatus Required:

01. Digital Multimeter 3 $\frac{3}{4}$ digit
02. Audio Frequency Generator
03. A.C. Millivoltmeter
04. Cathode Ray Oscilloscope 20MHz

Timer Applications IC 555 No.2

Order Code - 36248



Experimental Training Board has been designed specifically for the study of various Applications of the Timer IC 555.

Practical experience on this board carries great educative value for Science and Engineering Students.

Object:

To study the following Timer Applications of IC 555:

01. Pulse Generator.
02. Timer.
03. Sequential Timer.
04. Pulse Width Modulator (PWM).
05. Time Delay Circuits.

Features:

The board consists of the following built-in parts :

01. $\pm 9V$ D.C. at 60 mA, IC Regulated Power Supply internally connected.
 02. Pulse Carrier Generator with frequency of 2 KHz $\pm 10\%$.
 03. Sine Wave Generator with frequency of 100 Hz $\pm 10\%$.
 04. Pulser capable of generating a negative going pulse.
 05. LED driver circuit for time delay circuits.
 06. Two Timer ICs 555.
 07. Two Rotary Switches and adequate no. of other electronic components.
 08. Mains ON/OFF switch, Fuse and Jewel light.
- * The unit is operative on 230V $\pm 10\%$ at 50Hz A.C. Mains.
 - * Adequate no. of patch cords stackable from rear both ends 4mm spring loaded plug length $\frac{1}{2}$ metre.
 - * Good Quality, reliable terminal/sockets are provided at appropriate places on panel for connections / observation of waveforms.
 - * Strongly supported by detailed Operating Instructions, giving details of Object, Theory, Design procedures, Report Suggestions and Book References.

Other Apparatus Required:

01. Digital Stop Clock
02. Cathode Ray Oscilloscope 20MH

Study of Varactor Diode Characteristics

Order Code - 36249



Experimental Training Board has been designed specifically for the Study of Varactor Diode Characteristics.

Practical experience on this board carries great educative value for Science and Engineering Students.

Object:

01. To determine the Junction(transition) Capacitance of a Varactor Diode as a function of the reverse bias voltage and to evaluate the internal contact potential.
02. To use the Varactor Diode as a variable capacitor.

Features:

The board consists of the following built-in parts:

01. 0-10V D.C at 100mA, continuously variable regulated Power Supply.
02. D.C. Voltmeter, 65 mm Rectangular dial to read 0-10V.
03. Varactor Diode.
04. Inductor and adequate no. of other electronic components.
05. Mains ON/OFF switch, Fuse and Jewel light.
- * The unit is operative on 230V \pm 10% at 50Hz A.C. Mains.
- * Adequate no. of patch cords stackable from rear both ends 4mm spring loaded plug length 1/2 metre.
- * Good Quality, reliable terminal/sockets are provided at appropriate places on panel for connections / observation of waveforms.
- * Strongly supported by detailed Operating Instructions, giving details of Object, Theory, Design procedures, Report Suggestions and Book References.

Study of Inverting & Non-inverting Operational Amplifier

Order Code - 36250



Experimental Training Board has been designed specifically for the study of an Inverting and Non-Inverting Amplifier. This Training Board helps to know about the different aspects and need for such an Inverting and Non-Inverting amplifier.

Practical experience on this board carries great educative value for Science and Engineering Students.

Object:

01. To study Inverting Operational Amplifier.
02. To study Non-Inverting Operational Amplifier.
03. To study frequency response of Inverting A.C.

Operational Amplifier.

04. To study frequency response of Non-Inverting A.C. Operational Amplifier.
05. To study High Input Impedance of Inverting Amplifier.
06. To study High Input Impedance of Non-Inverting Amplifier.

Features:

The board consists of the following built-in parts:

01. +15V D.C. at 25mA, IC Regulated Power Supply
02. 0-2V D.C. at 50mA, continuously variable regulated Power Supply.
03. OP-AMP IC 741.
04. Adequate no. of other electronic components
05. Mains ON/OFF switch, Fuse and Jewel light.
- * The unit is operative on 230V \pm 10% at 50Hz A.C. Mains.
- * Adequate no. of patch cords stackable from rear both ends 4mm spring loaded plug length 1/2 metre.
- * Good Quality, reliable terminal/sockets are provided at appropriate places on panel for connections / observation of waveforms.
- * Strongly supported by detailed Operating Instructions, giving details of Object, Theory, Design procedures, Report Suggestions and Book References.

Study of Diode Detector

Order Code - 36251



Experimental Training Board has been designed specifically for the study of Amplitude Modulation and demodulation with basic Diode detector. The Training Board is helpful for the study of improved Diode Detector and detection of efficiency of a diode in Amplitude Modulation and Demodulation.

Practical experience on this board carries great educative value for Science and Engineering students.

Object:

To study the Diode Detector.

01. To modulate the carrier with audio signal and measure modulation index.
02. To demodulate the amplitude modulated waveform by the basic diode detector.
03. To demodulate the amplitude modulated waveform by the improved diode detector.
04. To study the detection efficiency of a Diode by direct method.

Features:

The board consists of the following built-in parts:

01. +9V DC at 100mA, regulated Power Supply internally connected.
02. D.C. Milliammeter, 65mm rectangular dial to read 0-1mA.
03. Carrier signal generator.
04. Modulating circuit based on two transistors.
05. Two Demodulating circuits, one for basic diode detector and other for improved diode detector.
06. Output transformer for modulated output.

- 07. Adequate no. of other electronic components.
- 08. Mains ON/OFF switch, Fuse and Jewel light.
- * The unit is operative on 230V \pm 10% at 50Hz A.C. Mains.
- * Adequate no. of patch cords stackable from rear both ends 4mm spring loaded plug length ½ metre.
- * Good Quality, reliable terminal/sockets are provided at appropriate places on panel for connections / observation of waveforms.
- * Strongly supported by detailed Operating Instructions, giving details of Object, Theory, Design procedures, Report Suggestions and Book References.

Other Apparatus Required:

01. Audio Frequency Generator
02. A.C. Millivoltmeter
03. Cathode Ray Oscilloscope 20MHz

Determination of The Resistance & Capacitance of a Capacitor

Order Code - 36252



Experimental Training Board has been designed specifically to determine the Resistance and Capacitance of a Capacitor with a source of alternating E.M.F. and three ammeters and a voltmeter. The unit is self contained and requires no other apparatus. Practical experience on this board carries great educative value for Science and Engineering Students.

Object:

To determine the resistance and capacitance of a capacitor using three ammeters and a voltmeter.

Features:

- The board consists of the following built-in parts :
01. Mains transformer having secondary tappings at 20V,30V, 40V, 50V and 60V at 500mA.
 02. Three A.C. Milliammeters, 65mm round dial to read 0-500mA.
 03. A.C. Voltmeter, 65mm round dial to read 0-75V.
 04. Capacitor of which capacitance and resistance has to be measured.
 05. 120 ohm/30W resistance.
 06. Mains ON/OFF switch, Fuse and Jewel light.
 - * The unit is operative on 230V \pm 10% at 50Hz A.C. Mains.
 - * Adequate no. of patch cords stackable from rear both ends 4mm spring loaded plug length ½ metre.
 - * Good Quality, reliable terminal/sockets are provided at appropriate places on panel for connections / observation of waveforms.
 - * Strongly supported by detailed Operating Instructions, giving details of Object, Theory, Design procedures, Report Suggestions and Book References.

Variation of Thermal Radiation With Temperature

Order Code - 36253



Experimental Training Board has been designed specifically for the study of the variation of the Total Thermal Radiation with Temperature (Verification of Stefan's Law of Radiation). The unit is self contained and requires no other apparatus.

Practical experience on this board carries great educative value for Science and Engineering Students.

Object:

To study the variation of the Total Thermal Radiation with Temperature.

Features:

- The board consists of the following built-in parts :
01. 0-6V D.C at 1A, IC regulated continuously variable Power Supply with coarse and fine voltage control.
 02. D.C. Voltmeter, 65mm rectangular dial with switch selectable ranges of 600mV and 6V.
 03. D.C. Ammeter, 65mm rectangular dial with switch selectable ranges of 500mA and 1A.
 04. Tungsten filament bulb of 6 Volt, 6W.
 05. Mains ON/OFF switch, Fuse and Jewel light.
 - * The unit is operative on 230V \pm 10% at 50Hz A.C. Mains.
 - * Adequate no. of patch cords stackable from rear both ends 4mm spring loaded plug length ½ metre.
 - * Good Quality, reliable terminal/sockets are provided at appropriate places on panel for connections / observation of waveforms.
 - * Strongly supported by detailed Operating Instructions, giving details of Object, Theory, Design procedures, Report Suggestions and Book References.

Applications of Operational Amplifier

Order Code - 36254



Experimental Training Board has been designed specifically for the study of basic Applications of Operational Amplifier (OP-AMP) using IC-741.

Practical experience on this board carries great educative value for Science and Engineering students.

Object:

To study the following applications of Operational Amplifier:

01. Inverting Amplifier.
02. Non-Inverting Amplifier.
03. Summing Amplifier or Adder.
04. Voltage Follower or Buffer Amplifier.

Features:

- The board consists of the following built-in parts :
01. \pm 15V D.C. at 50mA, IC Regulated Power Supply.
 02. Three 0-2V D.C. at 100mA, continuously variable regulated Power Supplies.
 03. OP-AMP IC 741.
 04. Adequate no. of other electronic components.
 05. Mains ON/OFF switch, Fuse and Jewel light.
 - * The unit is operative on 230V \pm 10% at 50Hz A.C. Mains.

- * Adequate no. of patch cords stackable from rear both ends 4mm spring loaded plug length ½ metre.
- * Good Quality, reliable terminal/sockets are provided at appropriate places on panel for connections / observation of waveforms.
- * Strongly supported by detailed Operating Instructions, giving details of Object, Theory, Design procedures, Report Suggestions and Book References.

Transistor Audio Amplifier With Power Supply and Different Loads

Order Code - 36255



Experimental Training Board has been designed specifically for the study of single stage Transistor Audio Amplifier with three different loads. Practical experience on this board carries great educative value for Science and Engineering Students.

Object:

To study single stage Transistor Audio Amplifier with three different loads (Resistive, Inductive & Transformer).

01. To measure the voltage gain of (CE) R.C. Coupled Transistor Audio Amplifier.
02. To plot the frequency response characteristics of (CE) R.C. Coupled Transistor Audio Amplifier.
03. To find out the Input Impedance of (CE) R.C. Coupled Transistor Audio Amplifier.
04. To find out the output Impedance of (CE) R.C. Coupled Transistor Audio Amplifier.

Features:

The board consists of the following built-in parts:

01. +12V D.C. at 100mA, IC regulated Power Supply internally connected.
 02. NPN transistor.
 03. Audio Output transformer.
 04. Adequate no. of other electronic components.
 05. Mains ON/OFF switch, Fuse and Jewel light.
- * The unit is operative on 230V \pm 10% at 50Hz A.C. Mains.
 - * Adequate no. of patch cords stackable from rear both ends 4mm spring loaded plug length ½ metre.
 - * Good Quality, reliable terminal/sockets are provided at appropriate places on panel for connections / observation of waveforms.
 - * Strongly supported by detailed Operating Instructions, giving details of Object, Theory, Design procedures, Report Suggestions and Book References.

Study of Recovery Time Of Diodes

Order Code - 36256



Experimental Training Board has been designed specifically to determine Recovery Time of given Diodes and study it as a function of frequency of operation and switching current.

Practical experience on this board carries great educative value for Science and Engineering Students.

Object:

Study of Recovery Time of Diodes.

01. To find out Recovery Time (reverse recovery time) of given Diodes.
02. To study Recovery Time (reverse recovery time) as a function of frequency of operation and switching current.

Features:

The board consists of the following built-in parts :

01. D.C. Microammeter, 65mm rectangular dial to read 0-50mA.
 02. Seven diodes and adequate no. of other electronic components.
- * Adequate no. of patch cords stackable from rear both ends 4mm spring loaded plug length ½ metre.
 - * Good Quality, reliable terminal/sockets are provided at appropriate places on panel for connections / observation of waveforms.
 - * Strongly supported by detailed Operating Instructions, giving details of Object, Theory, Design procedures, Report Suggestions and Book References.

Other Apparatus Required:

01. Function Generator
02. A.C. Millivoltmeter
03. Cathode Ray Oscilloscope 20MHz

Determination of Electronic Charge by Using a Rectifier

Order Code - 36257



Experimental Training Board has been designed specifically for determination of electronic charge (e) by using rectifier equation in case of a point contact germanium rectifier. The board is absolutely self contained and requires no other apparatus.

Practical experience on this board carries great educative value for Science and Engineering Students.

Object:

To determine the electronic charge (e) by using rectifier equation in case of a point contact germanium rectifier.

01. To note, change of current I with change of low voltage V in forward bias case and to plot the variation in log I & V and investigate linear region of the graph.
02. To determine the electronic charge (e) by using rectifier equation.

Features:

The board consists of the following built-in parts:

01. 500mV D.C. at 0.5mA, continuously variable

Power Supply.

02. F.E.T. Millivoltmeter, 65mm rectangular dial with switch selectable ranges of 100mV & 200mV.
03. D.C. Microammeter, 65mm rectangular dial with switch selectable ranges of 25mA and 250mA.
04. Two Germanium diodes.
05. Mains ON/OFF switch, Fuse and Jewel light.
- * The unit is operative on 230V $\pm 10\%$ at 50Hz A.C. Mains.
- * Adequate no. of patch cords stackable from rear both ends 4mm spring loaded plug length $\frac{1}{2}$ metre.
- * Good Quality, reliable terminal/sockets are provided at appropriate places on panel for connections / observation of waveforms.
- * Strongly supported by detailed Operating Instructions, giving details of Object, Theory, Design procedures, Report Suggestions and Book References.

Study of Phase Measurement by Superposition

Order Code - 36258



Experimental Training Board has been specifically designed for measurement of relative phase difference by superposition. The board is absolutely self contained and requires no other apparatus.

Practical experience on this board carries great educative value for Science and Engineering Students.

Object:

Study of phase measurement by superposition :

01. To study the relative phase difference between voltage across resistors and capacitors in series.
02. To measure the phase difference between V and V in a simple RC circuit. RC
03. To study more about phase relationship in an RC network.
04. To study the phase relationship in an LR circuit.
05. To study the phase of V in an LCR circuit. R
06. To study the phase relationships amongst various voltages in an LCR circuit.

Features:

The board consists of the following built-in parts:

01. Mains transformer having secondary tapings of 10V, 20V, 30V, 40V, 50V, 100 Volts at 100mA.
02. One Digital Panel Meter having dual range of 20V and 200V.
03. Four Inductors and adequate no. of other electronic components.
04. Mains ON/OFF switch, Fuse and Jewel light.
- * The unit is operative on 230V $\pm 10\%$ at 50Hz A.C. Mains.
- * Adequate no. of patch cords stackable from rear both ends 4mm spring loaded plug length $\frac{1}{2}$ metre.
- * Good Quality, reliable terminal/sockets are provided at appropriate places on panel for connections / observation of waveforms.
- * Strongly supported by detailed Operating Instructions, giving details of Object, Theory,

Design procedures, Report Suggestions and Book References.

Comparative Study of Bridge Rectifier and Precision Rectifier

Order Code - 36259



Experimental Training Board has been designed specifically for the Comparative study of Bridge Rectifier and Precision Rectifier using OPAMP ICs 741. This Training Board shows the effect of cut-in voltage of diode on full wave rectification using Bridge Rectifier, Precision Rectifier and their comparison for low voltage signals.

Practical experience on this board carries great educative value for Science and Engineering Students.

Object:

Comparative Study of Bridge Rectifier & Precision Rectifier.

Features:

The board consists of the following built-in parts:

01. 5V p-p and 10V p-p fixed A.C. at 50 Hz.
02. $\pm 15V$ D.C. at 50mA, IC regulated power supply internally connected.
03. 0-10V D.C. at 50mA continuously variable power supply.
04. D.C. Voltmeter, 65mm rectangular dial to read 0-15V.
05. Three OP-AMP ICs 741.
06. Adequate no. of Electronic Components.
07. Mains ON/OFF switch, Fuse and Jewel light.
- * The unit is operative on 230V $\pm 10\%$ at 50Hz A.C. Mains.
- * Adequate no. of patch cords stackable from rear both ends 4 mm spring loaded plug length $\frac{1}{2}$ metre.
- * Good Quality, reliable terminal/sockets are provided at appropriate places on panel for connections & observation of waveforms.
- * Strongly supported by detailed Operating Instructions, giving details of Object, Theory, Design procedures, Report Suggestions and Book References.

Square and Triangular Wave Generator With Positive and Negative Feedback

Order Code - 36260

Experimental Training Board has been designed specifically for the study of Square and Triangular Wave Generator with Positive and Negative Feedback using OP-AMP ICs 741. This Training Board is designed using Schmitt Trigger, Integrator and Inverting Amplifier to generate Square & Triangular waves using feedback principle. Also there are potentiometric controls for the change in Frequency, Amplitude and Duty cycle of waveforms.

Practical experience on this board carries great educative value for Science and Engineering Students.

Object:

01. To Study Generation of Square wave & Triangular wave using Schmitt Trigger, Integrator and Inverting Amplifier.
02. To Study Principle of positive & negative feedback.

Features:

The board consists of the following built-in parts:

01. $\pm 15V$ D.C. at 50mA, IC regulated power supply internally connected.
 02. Three OP-AMP ICs 741.
 03. Adequate no. of Electronic Components.
 04. Mains ON/OFF switch, Fuse and Jewel light.
- * The unit is operative on 230V $\pm 10\%$ at 50Hz A.C. Mains.
 - * Adequate no. of patch cords stackable from rear both ends 4 mm spring loaded plug length $\frac{1}{2}$ metre.
 - * Good Quality, reliable terminal/sockets are provided at appropriate places on panel for connections & observation of waveforms.
 - * Strongly supported by detailed Operating Instructions, giving details of Object, Theory, Design procedures, Report Suggestions and Book References.

Other Apparatus Required:

01. Cathode Ray Oscilloscope 20MHz

Scaling Amplifier

Order Code - 36261



Experimental Training Board has been designed specifically for the study of Scaling Amplifier using OP-AMP Ics 741. The board is absolutely self contained and requires no other apparatus.

Practical experience on this board carries great educative value for Science and Engineering Students.

Object:

01. To Study Scaling Amplifier, configured in such a way so that any type of transfer function i.e. Direct or Inverse with D.C. Offset (+ve or -ve) can be scaled.
02. To Study Adjustment of Angle of Transfer Function.

Features:

The board consists of the following built-in parts:

01. $\pm 15V$ D.C. at 50mA, IC regulated power supply internally connected.
 02. Two 0-10V D.C. at 50mA, continuously variable power supplies.
 03. Two D.C. Voltmeters, 65mm rectangular dial to read 0-15V.
 04. Two OP-AMP ICs 741.
 05. Adequate no. of Electronic Components.
 06. Mains ON/OFF switch, Fuse and Jewel light.
- * The unit is operative on 230V $\pm 10\%$ at 50Hz A.C. Mains.
 - * Adequate no. of patch cords stackable from rear both ends 4 mm spring loaded plug length $\frac{1}{2}$ metre.
 - * Good Quality, reliable terminal/sockets are

provided at appropriate places on panel for connections & observation of waveforms.

- * Strongly supported by detailed Operating Instructions, giving details of Object, Theory, Design procedures, Report Suggestions and Book References.

Zero Crossing Detector

Order Code - 36262



Experimental Training Board has been designed specifically for the study of Zero Crossing Detector using OP-AMP ICs 741. This Training Board is designed to have a better understanding of the generation of output pulses whenever input waveform crosses zero reference.

Practical experience on this board carries great educative value for Science and Engineering Students.

Object:

To generate synchronized pulses whenever A.C. Mains crosses zero line using Comparator, RC Differentiating Circuit etc.

Features:

The board consists of the following built in parts:

01. 10V p-p fixed A.C. at 50 Hz.
 02. $\pm 15V$ D.C. at 50mA, IC regulated power supply internally connected.
 03. Two OP-AMP ICs 741.
 04. Adequate no. of Electronic Components.
 05. Mains ON/OFF switch, Fuse and Jewel light.
- * The unit is operative on 230V $\pm 10\%$ at 50Hz A.C. Mains.
 - * Adequate no. of patch cords stackable from rear both ends 4 mm spring loaded plug length $\frac{1}{2}$ metre.
 - * Good Quality, reliable terminal/sockets are provided at appropriate places on panel for connections & observation of waveforms.
 - * Strongly supported by detailed Operating Instructions, giving details of Object, Theory, Design procedures, Report Suggestions and Book References.

Other Apparatus Required:

01. Dual Trace Cathode Ray Oscilloscope 20MHz

Window Detector

Order Code - 36263



Experimental Training Board has been designed specifically for the study of Window Detector using OP-AMP Ics 741. This Training Board gives a better understanding of the detection of Input signal when lying between a specified range of voltages. The board is absolutely self contained and requires no other apparatus.

Practical experience on this board carries great educative value for Science and Engineering Students.

Object:

To detect certain inputs when lying within specified range of voltages (window) using Inverting and Non-inverting Comparator.

Features:

The Board consists of the following built-in parts:

01. $\pm 15V$ D.C. at 50mA, IC regulated power supply internally connected.
02. D.C. Voltmeter, 65mm rectangular dial to read 0-15V.
03. Two OP-AMP ICs 741.
04. LEDs for visual indication of status.
05. Adequate no. of Electronic Components.
06. Mains ON/OFF switch, Fuse and Jewel light.
- * The unit is operative on 230V $\pm 10\%$ at 50Hz A.C. Mains.
- * Adequate no. of patch cords stackable from rear both ends 4 mm spring loaded plug length $\frac{1}{2}$ metre.
- * Good Quality, reliable terminal/sockets are provided at appropriate places on panel for connections & observation of waveforms.
- * Strongly supported by detailed Operating Instructions, giving details of Object, Theory, Design procedures, Report Suggestions and Book References.

Voltage to Current Converter

Order Code - 36264



Experimental Training Board has been designed specifically to study Voltage to Current Converter using OP-AMP ICs 741. This Training Board gives a deep understanding of the conversion of voltage into proportional current in both Inverting & Non-Inverting configurations. The board is absolutely self contained and requires no other apparatus.

Practical experience on this board carries great educative value for Science and Engineering Students.

Object

To Study the conversion of input voltage into proportional current irrespective of load for Inverting & Non-Inverting modes.

Features:

The Board consists of the following built-in parts:

01. $\pm 15V$ D.C. at 50mA, IC regulated power supply internally connected.
02. 0 - 5V D.C. at 50mA, continuously variable power supply.
03. Two OP-AMP ICs 741.
04. D.C. Milliammeter, 65mm rectangular dial with switch selectable ranges of 1mA and 5mA.
05. D.C. Voltmeter, 65mm rectangular dial to read 0-5V.
06. Adequate no. of Electronic Components.
07. Mains ON/OFF switch, Fuse and Jewel light.
- * The unit is operative on 230V $\pm 10\%$ at 50Hz A.C.

Mains.

- * Adequate no. of patch cords stackable from rear both ends 4 mm spring loaded plug length $\frac{1}{2}$ metre.
- * Good Quality, reliable terminal/sockets are provided at appropriate places on panel for connections & observation of waveforms.
- * Strongly supported by detailed Operating Instructions, giving details of Object, Theory, Design procedures, Report Suggestions and Book References.

Current to Voltage Converter

Order Code - 36265



Experimental Training Board has been designed specifically for the study of Current to Voltage Converter using OP-AMP ICs 741. This Training Board gives a deeper insight into conversion of current into proportional voltage. The board is absolutely self contained and requires no other apparatus.

Practical experience on this board carries great educative value for Science and Engineering Students.

Object:

01. To Study principles of voltage controlled current source.
02. To Study conversion of current to proportional voltage in Inverting & Non-Inverting modes.

Features:

The Board consists of the following built-in parts:

01. $\pm 15V$ D.C. at 100 mA, IC regulated power supply internally connected.
02. Two OP-AMP ICs 741.
03. Voltage controlled current source using OP-AMPs and Transistors.
04. D.C. Voltmeter, 65mm rectangular dial to read 0-15V.
05. D.C. Milliammeter, 65mm rectangular dial to read 0-10mA.
06. Adequate no. of Electronic Components.
07. Mains ON/OFF switch, Fuse and Jewel light.
- * The unit is operative on 230V $\pm 10\%$ at 50Hz A.C. Mains.
- * Adequate no. of patch cords stackable from rear both ends 4mm spring loaded plug length $\frac{1}{2}$ metre.
- * Good Quality, reliable terminal/sockets are provided at appropriate places on panel for connections & observation of waveforms.
- * Strongly supported by detailed Operating Instructions, giving details of Object, Theory, Design procedures, Report Suggestions and Book References.

Voltage to Frequency Converter

Order Code - 36266



Experimental Training Board has been designed specifically for the study of Voltage to Frequency Converter using OP-AMP ICs 741. This Training Board gives a better understanding of the conversion of Input D.C. voltage into proportional output frequency. Practical experience on this board carries great educative value for Science and Engineering Students.

Object:

To Study the conversion of Analogue D.C. voltage into proportional frequency with 50% duty cycle having linear relationship using Integrator, Schmitt Trigger and Master Slave J.K. flip flop in toggle mode.

Features:

The Board consists of the following built-in parts:

01. $\pm 15V$ D.C. at 50 mA, IC regulated power supply internally connected.
 02. $+ 5V$ D.C. at 50mA, IC regulated power supply internally connected.
 03. D.C Voltmeter, 65mm rectangular dial to read 0-15V.
 04. Two OP-AMP ICs 741.
 05. J.K. Flip Flop IC 4027.
 06. Adequate no. of Electronic Components.
 07. Mains ON/OFF switch, Fuse and Jewel light.
- * The unit is operative on $230V \pm 10\%$ at 50Hz A.C. Mains.
 - * Adequate no. of patch cords stackable from rear both ends 4 mm spring loaded plug length $\frac{1}{2}$ metre.
 - * Good Quality, reliable terminal/sockets are provided at appropriate places on panel for connections & observation of waveforms.
 - * Strongly supported by detailed Operating Instructions, giving details of Object, Theory, Design procedures, Report Suggestions and Book References.

Other Apparatus Required:

01. Cathode Ray Oscilloscope 20MHz
02. Frequency counter 6 digit

Under Voltage Monitoring

Order Code - 36267



Experimental Training Board has been designed specifically for the study on Under Voltage Monitoring using OPAMP IC 741. This Training Board gives a better understanding of the detection of input voltage when going below the specified range. Practical experience on this board carries great educative value for Science and Engineering Students.

Object:

To Study the under voltage state of AC mains with LED indication using OP-AMP as a closed loop Comparator in hysteresis operation.

Features:

The board consists of the following built in parts:

01. $\pm 15V$ D.C. at 50mA, IC regulated power supply

internally connected.

02. $+ 10V$ D.C. at 50mA, IC regulated power supply internally connected.
 03. OP-AMP IC 741.
 04. LEDs for visual indication of status.
 05. Relay.
 06. Adequate no. of Electronic Components.
 07. Mains ON/OFF switch, Fuse and Jewel light.
- * The unit is operative on $230V \pm 10\%$ at 50Hz A.C. Mains.
 - * Adequate no. of patch cords stackable from rear both ends 4mm spring loaded plug length $\frac{1}{2}$ metre.
 - * Good Quality, reliable terminal/sockets are provided at appropriate places on panel for connections & observation of waveforms.
 - * Strongly supported by detailed Operating Instructions, giving details of Object, Theory, Design procedures, Report Suggestions and Book References.

Other Apparatus Required:

01. Single phase Variac 0 to 230V, 1A.

Active Limiter

Order Code - 36268



Experimental Training Board has been designed specifically for the study of Active Limiter using OP-AMP ICs 741. This Training Board gives a better understanding of the principles of limiting of input voltage at output with specified limits of +ve & -ve voltages. The board is absolutely self contained and requires no other apparatus. Practical experience on this board carries great educative value for Science and Engineering Students.

Object:

01. To study active limiting of input at either polarity with adjustable limits using summing amplifier, unity gain amplifier and open loop comparator.
02. To study the comparison between Zener Limiter and Active Limiter.

Features:

The board consists of the following built-in parts:

01. $\pm 15V$ D.C. at 50mA, IC regulated power supply internally connected.
 02. $\pm 5V$ D.C. at 50mA, IC regulated power supply internally connected.
 03. D.C. Voltmeter, 65mm rectangular dial to read 0-5V.
 04. Four OP-AMP ICs 741.
 05. Adequate no. of Electronic Components.
 06. Mains ON/OFF switch, Fuse and Jewel light.
- * The unit is operative on $230V \pm 10\%$ at 50Hz A.C. Mains.
 - * Adequate no. of patch cords stackable from rear both ends 4 mm spring loaded plug length $\frac{1}{2}$ metre.
 - * Good Quality, reliable terminal/sockets are provided at appropriate places on panel for

- connections & observation of waveforms.
- * Strongly supported by detailed Operating Instructions, giving details of Object, Theory, Design procedures, Report Suggestions and Book References.
- * Weight : 3 Kg. (Approx.)
- * Dimension : W 340 x H 110 x D 210

R Y B Signal Generator

Order Code - 36269



Experimental Training Board has been designed specifically for the study of R Y B Signal Generator using OP-AMP ICs 741. This Training Board gives a better understanding of the generation of two additional sinusoidal signals from single phase with 120° phase shift using OPAMPs to obtain virtual R Y B sinusoidal signals.

Practical experience on this board carries great educative value for Science and Engineering Students.

Object:

To study generation 3 phase R Y B low voltage signals from single phase low voltage input.

Features:

The board consists of the following built-in parts:

01. ± 15V D.C. at 50mA, IC regulated power supply internally connected.
 02. 3V pp, 5V pp and 8V pp fixed A.C. at 50 Hz.
 03. Two OP-AMP ICs 741.
 04. Adequate no. of other Electronic Components.
 05. Mains ON/OFF switch, Fuse and Jewel light.
- * The unit is operative on 230V ±10% at 50Hz A.C. Mains.
 - * Adequate no. of patch cords stackable from rear both ends 4 mm spring loaded plug length ½ metre.
 - * Good Quality, reliable terminal/sockets are provided at appropriate places on panel for connections & observation of waveforms.
 - * Strongly supported by detailed Operating Instructions, giving details of Object, Theory, Design procedures, Report Suggestions and Book References.

Other Apparatus Required:

01. Dual Trace Cathode Ray Oscilloscope 20MHz.

Crystal Oscillator (Using CMOS ICs)

Order Code - 36270



Experimental Training Board has been designed specifically for the study of Crystal Oscillator using CMOS ICs. This Training Board gives a better Understanding of the Generation of stable and accurate frequency.

Practical experience on this board carries great

educative value for Science and Engineering students.

Object:

To Study Crystal Oscillator using CMOS ICs with crystal of frequency 32.768 KHz.

Features:

The board consists of the following built-in parts :

01. + 10V D.C. at 50mA, IC regulated power supply internally connected.
 02. Hex Inverter CMOS IC CD-4069.
 03. Hex Schmitt Trigger Inverter CMOS IC CD-4584.
 04. Crystal of frequency 32.768 KHz.
 05. Adequate no. of Electronic Components.
 06. Mains ON/OFF switch, Fuse and Jewel light.
- * The unit is operative on 230V ±10% at 50Hz A.C. Mains.
 - * Adequate no. of patch cords stackable from rear both ends 4 mm spring loaded plug length ½ metre.
 - * Good Quality, reliable terminal/sockets are provided at appropriate places on panel for connections & observation of waveforms.
 - * Strongly supported by detailed Operating Instructions, giving details of Object, Theory, Design procedures, Report Suggestions and Book References.

Binary Rate Multiplier

Order Code - 36271

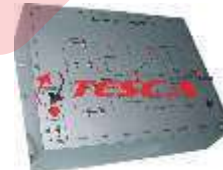

Experimental Training Board has been designed specifically for the study of Binary Rate Multiplier. This Training Board gives a better understanding of the working of binary rate multiplier for frequency division of input in binary steps.

Practical experience on this board carries great educative value for Science and Engineering Students.

Object:

To Study Binary Rate Multiplier to achieve output of desired frequency in binary steps, by dividing the available clock frequency with a selectable number (which is the Binary Rate) using Binary Rate Multiplier IC 4089.

Features:

The board consists of the following built-in parts :

01. + 10V D.C. at 50mA, IC regulated power supply internally connected.
 02. Binary Rate Multiplier CMOS IC 4089.
 03. Timer IC 555.
 04. LEDs for visual indication of status.
 05. SPDT switches for logic selection.
 06. Adequate no. of Electronic Components.
 07. Mains ON/OFF switch, Fuse and Jewel light.
- * The unit is operative on 230V ±10% at 50Hz A.C. Mains.
 - * Adequate no. of patch cords stackable from rear both ends 4 mm spring loaded plug length ½ metre.
 - * Good Quality, reliable terminal/sockets are provided at appropriate places on panel for

connections & observation of waveforms.

- * Strongly supported by detailed Operating Instructions, giving details of Object, Theory, Design procedures, Report Suggestions and Book References.

Other Apparatus Required:

01. Frequency Counter 6 digit
02. Dual Trace Cathode Ray Oscilloscope 20MHz

Synchronized Pulse Generator

Order Code - 36272



Experimental Training Board has been designed specifically for the study of Synchronized Pulse Generator. This Training Board gives a better understanding on the generation of Sync. pulses to trigger SCR in synchronism with the supply voltage using phase control principle.

Practical experience on this board carries great educative value for Science and Engineering Students.

Object:

To Study generation of synchronized pulses for triggering of Thyristor at the desired position.

Features:

The board consists of the following built-in parts:

01. $\pm 15V$ D.C. at 100mA, IC regulated power supply internally connected.
 02. $\pm 10V$ D.C. at 100mA, IC regulated power supply internally connected.
 03. $+ 5V$ D.C. at 100mA, IC regulated power supply internally connected.
 04. 8V p-p fixed A.C. at 50 Hz.
 05. Six OP-AMP ICs 741.
 06. Two Monostable Multivibrator ICs 4047.
 07. Timer IC 555.
 08. AND Gate IC 4081.
 09. Two JFETs.
 10. Pulse Transformer.
 11. Silicon Controlled Rectifier.
 12. Adequate no. of Electronic Components.
 13. Mains ON/OFF switch, Fuse and Jewel light.
- * The unit is operative on 230V $\pm 10\%$ at 50Hz A.C. Mains.
 - * Adequate no. of patch cords stackable from rear both ends 4mm spring loaded plug length $\frac{1}{2}$ metre.
 - * Good Quality, reliable terminal/sockets are provided at appropriate places on panel for connections & observation of waveforms.
 - * Strongly supported by detailed Operating Instructions, giving details of Object, Theory, Design procedures, Report Suggestions and Book References.

Other Apparatus Required:

01. Dual Trace Cathode Ray Oscilloscope 20MHz
02. Frequency Counter 6 digit

Phase Sequence Monitoring

Order Code - 36273



Experimental Training Board has been designed specifically for the study of Phase Sequence Monitoring. This Training Board gives a better understanding to detect whether the incoming low voltage three phase signal is in proper phase or not.

Practical experience on this board carries great educative value for Science and Engineering Students.

Object:

To study Detection of the Incoming low voltage R Y B phase sequence.

Features:

The board consists of the following built-in parts:

01. $\pm 15V$ D.C. at 50mA, IC regulated power supply internally connected.
 02. $+ 10V$ D.C. at 50mA, IC regulated power supply internally connected.
 03. Three OP-AMP ICs 741.
 04. D flip flop IC 4013.
 05. Nand Gate IC 4011.
 06. Two BC177 & one BC147 Transistors.
 07. Adequate no. of Electronic Components.
 08. Mains ON/OFF switch, Fuse and Jewel light.
- * The unit is operative on 230V $\pm 10\%$ at 50Hz A.C. Mains.
 - * Adequate no. of patch cords stackable from rear both ends 4mm spring loaded plug length $\frac{1}{2}$ metre.
 - * Good Quality, reliable terminal/sockets are provided at appropriate places on panel for connections & observation of waveforms.
 - * Strongly supported by detailed Operating Instructions, giving details of Object, Theory, Design procedures, Report Suggestions and Book References.

Other Apparatus Required:

01. R Y B Signal Generator

Photo Transistor Trainer

Order Code - 36274



Experimental Training Board has been designed specifically for the Study of Photo Transistor and its Application.

Practical experience on this board carries great educative value for Science and Engineering Students.

Object:

01. To Study generation of voltage corresponding to the change of light intensity on photo transistor.
02. To Study an application to drive a relay with OP-AMP used in comparator mode and a Transistor as control switch to operate the relay.

Features:

The board consists of the following built-in parts:

01. $\pm 12V$ D.C. at 150mA, IC regulated power supply internally connected.
 02. + 12V A.C. at 50mA, Supply with light intensity control.
 03. 12V lamp with lamp holder.
 04. Photo Transistor.
 05. 12V D.C. relay 1 green & 1 red LED.
 06. Two transistors SL100 & BC107.
 07. Adequate no. of Electronic Components.
 08. Mains ON/OFF switch, Fuse and Jewel light.
- * The unit is operative on 230V $\pm 10\%$ at 50Hz A.C. Mains.
 - * Adequate no. of patch cords stackable from rear both ends 4mm spring loaded plug, length $\frac{1}{2}$ metre.
 - * Good Quality, reliable terminal/sockets are provided at appropriate places on panel for connections & observation of waveforms.
 - * Strongly supported by detailed Operating Instructions, giving details of Object, Theory, Design procedures, Report Suggestions and Book References.

Other Apparatus Required:

01. Bulb 240V, 60W

2 Channel Analog Multiplexer

Order Code - 36275



Experimental Training Board has been designed specifically for the study of 2 Channel Analog Multiplexer. This Training Board gives a better understanding of the principle of multiplexing of analog signals.

Practical experience on this board carries great educative value for Science and Engineering Students.

Object:

To study multiplexing of two analog signals to give multiplexed output using JFETs.

Features:

The board consists of the following built-in parts :

01. $\pm 15V$ D.C. at 50mA, IC regulated power supply internally connected.
 02. - 5V D.C. at 50mA, IC regulated power supply internally connected.
 03. Two JEETs.
 04. OP-AMP IC 741.
 05. Adequate no. of Electronic Components.
 06. Mains ON/OFF switch, Fuse and Jewel light.
- * The unit is operative on 230V $\pm 10\%$ at 50Hz A.C. Mains.
 - * Adequate no. of patch cords stackable from rear both ends 4mm spring loaded plug, length $\frac{1}{2}$ metre.
 - * Good Quality, reliable terminal/sockets are provided at appropriate places on panel for connections & observation of waveforms.
 - * Strongly supported by detailed Operating Instructions, giving details of Object, Theory, Design procedures, Report Suggestions and Book References.

Other Apparatus Required:

01. Dual Trace Cathode Ray Oscilloscope, 20MHz.
02. 2 Nos. Function Generator

Study Of Schmitt's Trigger Circuit

Order Code - 36276



Experimental Training Board has been designed specifically for the study of Schmitt's Trigger Circuit based on IC- 741. This Training Board is quite useful in studying the hysteresis associated with the schmitt trigger and the effect of feedback on threshold voltages.

Practical experience on this board carries great educative value for Science and Engineering Students.

Object:

To study Schmitt's Trigger Circuit for the following.

01. Upper threshold voltage
02. Lower threshold voltage
03. Hysteresis
04. Effect of feedback on threshold voltage

Features:

The board consists of the following built-in parts :

01. $\pm 15V$ D.C. At 50mA, IC regulated Power Supply internally connected
 02. OP-AMPIC-741
 03. Single Pole Five Way Switch
 04. Adequate no. of other electronic components.
 05. Mains ON/OFF switch and Fuse.
- * The unit is operative on 230V $\pm 10\%$ at 50Hz A.C. Mains.
 - * Adequate no. of patch cords stackable from rear both ends 4mm spring loaded plug length $\frac{1}{2}$ metre.
 - * Good Quality, reliable terminal/sockets are provided at appropriate places on panel for connections /observation of waveforms.
 - * Strongly supported by detailed Operating Instructions, giving details of Object, Theory, Design procedures, Report Suggestions and Book References.

Other Apparatus Required:

01. Dual Trace Cathode Ray Oscilloscope, 15MHz
02. Function Generator

Current Amplification Factor of a Transistor

Order Code - 36277



Training Board has been designed specifically to study the Current Amplification of a Transistor. The board is absolutely self contained and requires no other apparatus.

Practical experience on this board carries great educative value for Science and Engineering Students.

Object:

To determine the current amplification factor of a

Transistor graphically.

Features:

The board consists of the following built-in parts :

01. 6V D.C. at 100mA, regulated Power Supply.
 02. 0-6V D.C. at 100mA, continuously variable Power Supply.
 03. D.C. Digital Voltmeter 3½ digits having range 20V.
 04. D.C. Digital Current meter 3½ digits having range 200 mA.
 05. D.C. Digital Current meter 3½ digits having range 2 mA.
 06. Potentiometer to vary the base current.
 07. Transistor with Heat Sink.
 08. Adequate no. of other electronic components.
 09. Mains ON/OFF switch and Fuse.
- * The unit is operative on 230V ±10% at 50Hz A.C. Mains.
 - * Adequate no. of patch cords stackable from rear both ends 4mm spring loaded plug length ½ metre.
 - * Good Quality, reliable terminal/sockets are provided at appropriate places on panel for connections/observation of waveforms.
 - * Strongly supported by detailed Operating Instructions, giving details of Object, Theory, Design procedures, Report Suggestions and Book References.

Determination of Internal Resistance of a D.C. Power Source

Order Code - 36278



Training Board has been designed specifically to determine the Internal Resistance of a D.C. source by matching a load for maximum power transfer. The board is absolutely self contained and requires no other apparatus.

Practical experience on this board carries great educative value for Science and Engineering Students.

Object:

To determine the internal resistance of a D.C. source by matching a load for maximum power transfer.

Features:

The board consists of the following built-in parts :

01. 5V D.C. at 1A, regulated Power Supply with a internal resistance.
 02. D.C. Digital Current meter 3½ digits having range 2 Amp.
 03. D.C. Digital Voltmeter 3½ digits having range 20V.
 04. Adequate no. of other electronic components.
 05. Mains ON/OFF switch and fuse.
- * The unit is operative on 230V ±10% at 50Hz A.C. Mains.
 - * Adequate no. of patch cords stackable 4mm spring loaded plug length ½ metre.
 - * Good Quality, reliable terminal/sockets are provided at appropriate places on panel for connections/observation of waveforms.
 - * Strongly supported by detailed Operating Instructions, giving details of Object, Theory, Design procedures, Report Suggestions and Book

References.

Smps Trainer Kit (for Colour Television)

Order Code - 36279



Experimental Training Board has been designed specifically for the study of Switching Mode Power Supply (SMPS) for Colour Television. The training board is assembled on enlarged PCB with different test points to observe waveforms and voltages. Now a days Switching Mode Power Supplies are extensively used in Colour Televisions i.e. 14" & 20" CTV's. Practical experience on this board carries great educative value for Science and Engineering Students.

Object:

01. To study different sections of SMPS.
02. To locate typical components and Input/Output signals.
03. To measure the voltages at test points and Input/Output signals.
04. To study the circuit in detail.
05. To create faults by removing components and observe their effect.

Technical Specifications:

01. High Voltage Output : 110V / 115V ± 5% at 550mA max.
 02. Low Voltage Outputs : 24V ± 2% at 1 Amp. Max. 18V ± 2% at 1 Amp. Max. 12V ± 2% at 1 Amp. max.
 03. Input Voltage : 180V to 270VAC, 50Hz.
 04. Power Output : 90 Watts ± 10 Watts / (as required for 20" Colour Television).
- * Good Quality, reliable terminal/sockets are provided at appropriate places on panel for connections/ observation of waveforms/voltages

Other Apparatus Required

01. Digital Multimeter 3½ Digits
02. Cathode Ray Oscilloscope 20 MHz
03. Variac 2Amp
04. Rheostat up to 24E, 1Amp
05. Bulb 60W with Holder for 110V D.C. Test.

Smps Trainer Kit (for Computers)

Order Code - 36280



Experimental Training Board has been designed specifically for the study of Switching Mode Power Supply (SMPS) for computer. Now a days Switching Mode Power Supplies are extensively used in various electronic instruments and computers. Practical experience on this board carries great educative value for Science and Engineering Students.

Object:

01. To study the different sections of SMPS.
02. To locate typical components and Input/Output signals.

03. To measure the voltages at test points and Input/Output signals.
04. To study the circuit in detail.
05. To create faults by removing components and observe their effect.

Technical Specifications:

01. Based on IC 494 as PWM.
02. Input Voltage : 170V to 260VAC. 50Hz.
03. Output Voltage : +5V, -5V, +12V, -12V, Power good signal voltage/as required in computers.
04. Wattage (I/P) : 150 Watt (approx.)

Features:

01. IC 494 used as PWM on socket.
 02. Six pairs of Output Lead are provided.
 03. Trainer assembled on enlarged PCB.
 04. Fan cooling facility provided.
- * Good Quality, reliable terminal/sockets are provided at appropriate places on panel for connections/observation of waveforms.

Other Apparatus Required:

01. Digital Multimeter 3½ digits
02. Cathode Ray Oscilloscope, 15MHz
03. Variac 8Amp

Accessories:

03. FAN 12V, 0.14A, brushless.

Solar Educational Kit

Order Code - 36281



Solar Educational kit has been designed specifically to make students in educational institutes aware of the elementary principles of solar energy and its applications. With the help of the kit, one can study solar photovoltaic system, its electrical characteristics and applications. The training kit will be quite educative to students in schools and at pre-university and college levels.

Object:

01. To study Photo Voltaic Module characteristics by plotting I-V curve.
02. To demonstrate the electrical appliances on both the Solar Module and the battery.

Features:

Solar Educational kit consists of :

01. SOLAR MODULE : The solar module (3 volt nominal) used in this kit is formed out of a single silicon solar cell cut into 8 parts and then soldered together to form an assembly of 8 solar cells in series. The module can provide power upto 1 watt.
02. NICKEL CADMIUM (Ni-Cd) BATTERY: The nickel cadmium battery cells, connected in series store the electricity generated by the solar cells so that the loads can be used even while the module is unexposed to light.
03. D.C. Voltmeter, 65 mm rectangular dial to read 0-5V D.C.
04. D.C. Milliammeter, 65 mm rectangular dial to read 0-250mA D.C.

05. POTENTIOMETER : The Potentiometer plays the part of a variable resistor during the operation.
 06. Switches for module characteristic mode and solar PV system mode.
 07. Electrical appliances supplied with the Kit for live demonstration are Transistor Radio set, Calculator, Torch, Clock, Musical-bell
- * Strongly supported by detailed Operating Instructions, giving details of Object, Theory, Design procedures, Report Suggestions and Book References.

Temperature of a Torch Bulb Filament by Its Resistance Measurements

Order Code - 36282

Experimental Training Board has been designed specifically for obtaining the temperature of a torch bulb filament by its resistance measurements. The board is absolutely self contained and requires no other apparatus. Practical experience on this board carries great educative value for Science and Engineering Students.

Object:

To determine the temperature of a torch bulb filament by its resistance measurements.

Features:

The board consists of the following built-in parts :

01. 0-6V D.C. at 2A, I.C. regulated continuously variable and short circuit protected power supply, with coarse and fine voltage control.
02. Two Digital Panel Meters (for measurement of D.C. voltage and current). specifications

Voltage Current

Range 19.99V to 1.999Amp.

Resolution 10mV. 1mA

Accuracy $\pm 0.2\% \pm 1$ digit $\pm 0.2\% \pm 1$ digit

I/P Impedance 10 M ohms 0.1 ohms

Display : 3½ digit, 7 segment LED (12.5mm height).

Auto : Polarity indication.

Over Load Indication : Sign of 1 on left and blanking of other digits.

03. Incandescent lamp.

04. Mains ON/OFF switch and Fuse.

- * The unit is operative on 230V $\pm 10\%$ at 50Hz A.C. Mains.
- * Good Quality, reliable terminal/sockets are provided at appropriate places on panel for connections.
- * Strongly supported by detailed Operating Instructions, giving details of Object, Theory, Design procedures, Report Suggestions and Book References.

Electronic Siren Using Timer Ics

Order Code - 36283



Experimental Training Board has been designed specifically for the study of Electronic Siren using Timer ICs. This training board gives a better understanding of timer IC application as a Astable Multivibrator &

frequency modulation of timer O/P with the sawtooth voltage. The board is absolutely self contained and requires no other apparatus. Practical experience on this board carries great educative value for Science and Engineering Students.

Object:

To Study an Electronic Siren using Timer Ics.

Features:

The board consists of the following built-in parts :

01. +5V D.C. at 100mA, IC regulated power supply internally connected.
 02. Two Timer ICs.
 03. Speaker (8W) for output.
 04. Two potentiometers.
 05. "Push to ON" switch for putting Siren ON.
 06. Adequate no. of other electronic components.
 07. Mains ON/OFF switch, Fuse and Jewel light.
- * The circuit is operative on 230V \pm 10% at 50Hz A.C. Mains.
 - * Good Quality, reliable terminal/sockets are provided at appropriate places on panel for connections/observation of waveforms.
 - * Strongly supported by detailed Operating Instructions, giving details of Object, Theory, Design procedures, Report Suggestions and Book References.

Burglar Alarm Using Timer IC & LDR

Order Code - 36284



Experimental Training Board has been designed specifically to study the Burglar Alarm using Timer IC & LDR. This training board gives a better understanding of timer IC application as a astable multivibrator. This board is absolutely self contained and requires no other apparatus.

Practical experience on this board carries great educative value for Science and Engineering Students.

Object:

To Study Burglar Alarm using Timer IC & LDR.

Features:

The board consists of the following built in parts :

01. +12V D.C. at 1A , IC regulated power supply internally connected.
 02. Timer IC.
 03. Speaker (8E) for output.
 04. LDR mounted on panel.
 05. Adequate no. of other electronic components.
 06. Mains ON/OFF switch, Fuse and Jewel light.
- * The unit is operative on 230V \pm 10% at 50Hz A.C. Mains.
 - * Good Quality, reliable terminal/sockets are provided at appropriate places on panel for connections/observation of waveforms.
 - * Strongly supported by detailed Operating Instructions, giving details of Object, Theory, Design procedures, Report Suggestions and Book References.

Verification of Stefan's Law of Radiation by Using an Incandescent Lamp

Order Code - 36285

Experimental Training Board has been designed specifically for the verification of Stefan's law of radiation by using an incandescent lamp. The board is absolutely self contained and requires no other apparatus.

Practical experience on this board carries great educative value for Science and Engineering Students.

Object:

01. To verify the Stefan's law of radiation by using an incandescent lamp.

Features:

The board consists of the following built-in parts :

01. 0-6V D.C. at 2A, IC regulated continuously variable and short circuit protected Power Supply with coarse and fine voltage control.
 02. D.C. Voltmeter, 65mm rectangular dial with switch selectable ranges of 60mV and 6V.
 03. D.C. Current meter, 65mm rectangular dial with switch selectable ranges of 30mA and 3A.
 04. Incandescent lamp.
 05. Mains ON/OFF switch, Fuse and Jewel light.
- * The unit is operative on 230V \pm 10% at 50Hz A.C. Mains.
 - * Good Quality, reliable terminal / sockets are provided at appropriate places on panel for connections /observation of waveforms.
 - * Strongly supported by detailed Operating Instructions, giving details of Object, Theory, Design procedures, Report Suggestions and Book References.

Study of The Charge and Discharge of a Condenser Through a Resistance Using Neon Bulb

Order Code - 36286



Experimental Training Board has been designed specifically to study the Charge and Discharge of a condenser through a resistance using neon bulb.

Practical experience on this board carries great educative value for Science and Engineering Students.

Object:

01. To study the Charge and Discharge of a condenser through a resistance using neon bulb.
02. To study the dependence of the period on the source voltage and deducing striking voltage and extinction voltage of the neon bulb.

Features:

The board consists of the following built-in parts :

01. 0-300V D.C. at 20mA, I.C. regulated continuously variable and short circuit protected Power Supply with coarse and fine voltage control.
02. Digital Panel Meter (for measurement of DC voltage).

Technical Specifications:

Voltage Range : 0-1000 volt.
 Resolution : 1V.
 Accuracy : $\pm 0.2\% \pm 2$ digit.
 Input Impedance : 10 M ohms.
 Display : $3\frac{1}{2}$ digit, 7 segment LED (12.5mm height)
 Auto : Polarity indication.
 Over Load Indication : Sign of 1 on left and blanking of other digits.

- * Adequate no. of Resistances and Capacitances.
- * Neon bulb mounted on panel.
- * Mains ON/OFF switch and Fuse.
- * The unit is operative on 230V $\pm 10\%$ at 50Hz A.C. Mains.
- * Adequate no. of patch cords stackable from rear both ends 4mm spring loaded plug length $\frac{1}{2}$ metre.
- * Good Quality, reliable terminal/sockets are provided at appropriate places on panel for connections/observation of waveforms.
- * Strongly supported by detailed Operating Instructions, giving details of Object, Theory, Design procedures, Report Suggestions and Book References.

Other Apparatus Required:

01. Digital stop clock

L-C Transmission Line (48 Sections)

Order Code - 36287



Experimental Training Board has been designed specifically to the study of L-C Transmission Line (48 sections).

Practical experience on this board carries great educative value for Science and Engineering Students.

Object:

01. To study Propagation along L-C ladder network having. 48 sections and find out the propagation constant.

Features:

The board consists of the following built-in parts :

01. 48 Inductances.
02. 48 Capacitances.
03. Mains ON/OFF switch, Fuse and Jewel light.
- * The unit is operative on 230V $\pm 10\%$ at 50Hz A.C. Mains.
- * Good Quality, reliable terminal/sockets are provided at appropriate places on panel for connections.
- * Strongly supported by detailed Operating Instructions, giving details of Object, Theory, Design procedures, Report Suggestions and Book References.

Other Apparatus Required:

01. Digital Multimeter $3\frac{3}{4}$ digit

Wien Bridge Oscillator (Op-Amp Version)

Order Code - 36288



Experimental Training board has been designed specifically to study of Wien bridge oscillator (Op-Amp version).

Experience on the board carries great educative value for Science & Engineering Students.

Object:

01. To construct a Wien-Bridge oscillator and determine the resistor ratio required to develop the correct degenerative feedback.
02. To vary the value of resistance and capacitance in the lead leg network and to observe the resultant frequency changes.

Features:

The board consists of the following built in parts :

01. $\pm 15V$ D.C. at 50mA. IC regulated power supply internally connected.
02. OP-Amp IC.
03. Feedback control by potentiometer.
04. Nine frequencies selectable by two band switches.
05. Adequate no. of other electronic components.
06. Mains ON/OFF switch, Fuse and Jewel light.

Unit is operative on 230V $\pm 10\%$ at 50 Hz A.C. mains.

- * Good quality, reliable terminals/sockets are provided at appropriate places on panel for connections/observations of waveforms.
- * Strongly supported by detailed Operating Instructions, giving details of Object, Theory, Design procedures, Report Suggestions and Book References.

Quadrature Oscillator

Order Code - 36289



Experimental Training board has been designed specifically to study of quadrature oscillator. It produces sine wave 0 and cosine wave that are in out of phase by 90 .

Practical experience on this board carries great educative value for science and engineering students.

Object:

01. To study constructional features of quadrature oscillator.
02. To verify the generation of two signal (sine & cosine) that are in quadrature i.e. out of phase by 90 .
03. To study the variation in frequency by varying the values of components.

Features:

The board consists of the following built in parts :

01. $\pm 15V$ D.C. at 50mA. IC regulated power supply

internally connected.

02. OP-Amp IC.
 03. A selector switch provided to select three frequencies.
 04. Two potentiometers for feed back control (coarse & fine control)
 05. Adequate no. of other electronic components.
 06. Mains ON/OFF switch, fuse and jewel light.
- * Unit is operative on $230V \pm 10\%$ at 50 Hz A.C. mains
 - * Good quality, reliable terminals/sockets are provided at appropriate places on panel for connections/observations of waveforms.
 - * Strongly supported by detailed Operating Instructions, giving details of Object, Theory, Design procedures, Report Suggestions and Book References.

Other Apparatus Required:

01. Cathode Ray Oscilloscope 20MHz.
02. Digital Frequency counter

Conversion of Galvanometer Into a Voltmeter

Order Code - 36290



Training Board has been designed specifically for study of Conversion of a Galvanometer into a Voltmeter. The board is absolutely self contained and requires no other apparatus. Practical experience on this board carries great educative value for Science and Engineering Students.

Object:

01. To determine the resistance of a Galvanometer by half deflection method.
02. To determine the figure of merit of the Galvanometer.
03. To convert the Galvanometer into a Voltmeter of a given range and to calibrate it.

Features:

The board consists of the following built-in parts :

01. Galvanometer, 65mm rectangular dial having 30-0-30 scale.
 02. 5V D.C. at 50mA, IC regulated Power Supply.
 03. D.C. Voltmeter, 65mm rectangular dial to read 0-5V.
 04. Necessary Shunt & Series Resistances.
 05. Potentiometer and adequate no. of other electronic components.
 06. Mains ON/OFF switch, Fuse and Jewel light.
- * The unit is operative on $230V \pm 10\%$ at 50Hz A.C. Mains.
 - * Adequate no. of patch cords stackable from rear both ends 4mm spring loaded plug length $\frac{1}{2}$ metre.
 - * Good Quality, reliable terminal/sockets are provided at appropriate places on panel for connections / observation of waveforms.
 - * Strongly supported by detailed Operating Instructions, giving details of Object, Theory, Design procedures, Report Suggestions and Book References.

Conversion of Galvanometer Into An Ammeter

Order Code - 36291



Training Board has been designed specifically for the study of Conversion of a Galvanometer into an Ammeter. The board is absolutely self contained and requires no other apparatus. Practical experience on this board carries great educative value for Science and Engineering Students.

Object:

01. To determine the resistance of a Galvanometer by half deflection method.
02. To determine the figure of merit of the Galvanometer.
03. To convert the Galvanometer into an Ammeter of a given range and to calibrate it.

Features:

The board consists of the following built-in parts :

01. +5V D.C. at 50mA, IC regulated Power Supply.
 02. Galvanometer, 65mm rectangular dial to read 30-0-30.
 03. D.C. Milliammeter, 65mm rectangular dial to read 0-50mA.
 04. Potentiometer and adequate no. of other electronic components.
 05. Mains ON/OFF switch, Fuse and Jewel light.
- * The unit is operative on $230V \pm 10\%$ at 50Hz A.C. Mains.
 - * Adequate no. of patch cords stackable from rear both ends 4mm spring loaded plug length $\frac{1}{2}$ metre.
 - * Good Quality, reliable terminal/sockets are provided at appropriate places on panel for connections / observation of waveforms.
 - * Strongly supported by detailed Operating Instructions, giving details of Object, Theory, Design procedures, Report Suggestions and Book References.

Ionisation Potential of Mercury Using Gas Filled Diode

Order Code - 36292



Experimental Training Board has been designed specifically to find the ionisation potential of mercury using gas filled diode. The board is absolutely self contained and requires no other apparatus. Practical experience on this board carries great educative value for Science and Engineering Students.

Object:

- To find the ionisation potential of mercury using gas filled diode.

Features:

The board consists of the following built-in parts :

01. A gas filled (mercury vapour) diode.

02. Power supply IC regulated continuously variable and short circuit protected for plate voltage.
03. A.C. Power supply for filament
04. Digital D.C. Voltmeter, 3½ digit, 7 segment display
05. Digital D.C. Milliammeter, 3½ digit, 7 segment display
06. Resistance
 - * The unit is operative on 230V ±10% at 50Hz A.C. Mains.
 - * Adequate no. of patch cords stackable from rear both ends 4mm spring loaded plug length ½ metre.
 - * Good Quality, reliable terminal/sockets are provided at appropriate places on panel for connections / observation of waveforms.
 - * Strongly supported by detailed Operating Instructions, giving details of Object, Theory, Design procedures, Report Suggestions and Book References.

Electrical Thermionic Fundamental Trainer

Order Code - 36293



Experimental Training Board has been designed specifically for to determine the thermionic work function of tungsten using a directly heated valve and Verification of Richardson's Equation of thermionic emission. The board is absolutely self contained and requires no other apparatus. Practical experience on this board carries great educative value for Science and Engineering Students.

Object:

01. Determination of the thermionic work function of tungsten using directly heated valve.
02. Verification of Richardson equation of thermionic emission.

Features:

The board consists of the following built-in parts :

01. I.C. Regulated Power Supply for Filament.
02. I.C. Regulated Power Supply for Plate.
03. Digital Voltmeter for Filament.
04. Digital Current meter for Filament.
05. Digital Voltmeter for Plate.
06. Digital Current meter for Plate.
07. Directly Heated Diode.
- * The unit is operative on 230V ±10% at 50Hz A.C. Mains.
- * Adequate no. of patch cords stackable from rear both ends 4mm spring loaded plug length ½ metre.
- * Good Quality, reliable terminal/sockets are provided at appropriate places on panel for connections / observation of waveforms.
- * Strongly supported by detailed Operating Instructions, giving details of Object, Theory, Design procedures, Report Suggestions and Book References.

Zener Regulated and IC Regulated Power Supply

Order Code - 36294



Experimental Training Board has been designed specifically for the study of zener regulated and IC regulated power supply. This training board is absolutely self contained and requires no other apparatus.

Practical experience on this board carries great educative value for Science and Engineering Students.

Object:

01. To study unregulated Power Supply
02. To study zener regulated Power Supply.
03. To study IC regulated Power Supply.

Features:

The complete experimental board consists of the following built-in parts :

01. 12VA.C. at 150mA Power Supply.
02. ±15V D.C. at 100mA IC regulated Power Supply internally connected.
03. Digital Voltmeter 3½ digits having range 20V D.C.
04. Digital Milliammeter 3½ digits having range 200mA D.C.
05. Digital Voltmeter 3½ digits having range 2VA.C.
06. One Potentiometer to vary load.
07. Adequate no. of other electronic components.
08. Mains ON/OFF Switch and fuse.
- * The unit is operative on 230V ± 10% at 50 Hz A.C. mains.
- * Adequate no. of patch cords stackable 4mm spring loaded plug length ½ metre.
- * Good Quality, reliable terminal/sockets are provided at appropriate places on panel for connections / observation of waveforms.
- * Strongly supported by detailed Operating Instructions, giving details of Object, Theory, Design procedures, Report Suggestions and Book References.

Study of Staircase Generator

Order Code - 36295



Experimental training board has been designed specifically to study the Staircase Generator.

Practical experience on this board carries great educative value for Science and Engineering Students.

Object:

To study Staircase Generator.

Features:

The board consists of the following built-in parts :

01. +12V D.C. at 30mA IC regulated Power Supply internally connected.
02. Two transistor one NPN and another PNP.
03. One Potentiometer to control division ratio.
04. One Unijunction Transistor.
- * Adequate no. of other electronic components.
- * Mains ON/OFF switch, fuse and jewel light.
- * The unit is operative on 230V ± 10% at 50 Hz A.C. mains.
- * Adequate no. of patch cords stackable 4mm spring loaded plug length ½ metre.
- * Good quality, reliable terminals/sockets are

provided at appropriate places on panel for connections/observations of waveforms.

- * Strongly supported by detailed Operating Instructions, giving details of Object, Theory, Design procedures, Report Suggestions and Book References.

Verification of Superposition, Thevenin's & Reciprocity Theorems

Order Code - 36296



Experimental training board has been designed specifically for the study & verification of network theorems in D.C. circuits. The board is absolutely self contained and requires no other apparatus. Practical experience on this board carries great educative value for Science and Engineering Students.

Object:

01. To verify the Superposition Theorem and to calculate current in any branch of a multisource using Superposition Theorem
02. To verify Thevenin's Theorem and to calculate Thevenin's equivalent of given circuit.
03. To verify the Reciprocity Theorem and to measure current in a branch containing voltage source after shifting it to some other branch.

Features:

The board consists of the following built-in parts :

01. +9V D.C. at 20mA, IC regulated Power Supply.
02. 0 - 12V D.C. at 20mA, continuously variable regulated Power Supply.
03. Digital voltmeter 3½ digits having range 20 V D.C.
04. Three Digital Milliammeters 3½ digit having range 20mA D.C.
05. Adequate no. of other electronic components.
 - * Mains ON/OFF switch and fuse.
 - * The unit is operative on 230V ± 10% at 50 Hz A.C. mains.
 - * Adequate no. of patch cords stackable 4mm spring loaded plug length ½ metre.
 - * Good quality, reliable terminals/sockets are provided at appropriate places on panel for connections/observations of waveforms.
 - * Strongly supported by detailed Operating Instructions, giving details of Object, Theory, Design procedures, Report Suggestions and Book References.

Critical Potentials of an Atomic Gas Filled in Electronic Valve

Order Code - 36297

Experimental training board has been designed specifically to study of the Critical Potentials of an atomic gas filled in electronic valve. Practical experience on this board carries great educative value for Science and Engineering Students.

Object:

To study Critical Potentials of an atomic gas filled in electronic valve.

01. Determination of Excitation Potential of an atomic gas filled in electronic valve.
02. Determination of Ionization Potential of an atomic gas filled in electronic valve.

Features:

The board consists of the following built-in parts :

01. A directly heated tetrode valve with base fixed on panel.
02. 1V5 D.C. at 20mA, IC regulated Power Supply.
03. 0 - 20V D.C. at 20mA, continuously variable regulated Power Supply.
04. Digital Voltmeter 3½ digit having range 20V D.C.
05. 6V3 A.C. at 600mA, for filament
 - * Adequate no. of other electronic components.
 - * Mains ON/OFF switch and fuse.
 - * The unit is operative on 230V ± 10% at 50 Hz A.C. mains.
 - * Adequate no. of patch cords stackable 4mm spring loaded plug length ½ metre.
 - * Good quality, reliable terminals/sockets are provided at appropriate places on panel for connections/observations of waveforms.
 - * Strongly supported by detailed Operating Instructions, giving details of Object, Theory, Design procedures, Report Suggestions and Book References.

Other Apparatus Required:

01. Digital Nanometer

Voltage Controlled Oscillator Trainer (V.C.O.)

Order Code - 36298



Experimental training board has been designed specifically for the study of Voltage Controlled Oscillator (V.C.O.)

Practical experience on this board carries great educative value for Science and Engineering Students.

Object:

To study Voltage Controlled Oscillator (V.C.O.) and verify the frequency variation in accordance with input voltage.

01. Constant frequency
02. Wide range VCO, variable from near zero to above 1.5 KHz.
03. Wide range VCO with frequency fully variable down to zero
04. Restricted range VCO
05. Universal Clock/Square wave Generator
06. FSK Generator.

Features:

The board consists of the following built-in parts :

01. +9V D.C. at 50mA, IC regulated Power Supply.
02. CMOS Phase Locked Loop (PLL) IC
03. Quad 2-input Nand schmitt trigger IC
04. Two Potentiometers.
05. Two diodes and adequate no. of other electronic

components.

- * Mains ON/OFF switch, fuse and jewel light.
- * The unit is operative on 230V \pm 10% at 50 Hz A.C. mains.
- * Adequate no. of patch cords stackable 4mm spring loaded plug length ½ metre.
- * Good quality, reliable terminals/sockets are provided at appropriate places on panel for connections/observations of waveforms.
- * Strongly supported by detailed Operating Instructions, giving details of Object, Theory, Design procedures, Report Suggestions and Book References.

Study Of Forbidden Energy Gap

Order Code - 36299



Experimental Training Board has been designed specifically to study the Forbidden Energy Gap in Semiconductor Diode. The board is absolutely self contained and requires no other apparatus. Practical experience on this board carries great educative value for Science and Engineering Students.

Object:

To study the Forbidden Energy Gap in Semiconductor Diode.

Features:

The board consists of the following built-in parts :

01. 2V D.C. at 10mA, regulated Power Supply.
 02. Digital Microammeter, 3½ digits having range 200mA D.C.
 03. Semiconductor Diode.
 04. Thermometer 0-110 °C.
 05. Oven, Electrically heated to heat the Semiconductor Diode.
 06. Mains ON/OFF switch and Fuse.
- * The unit is operative on 230V \pm 10% at 50Hz A.C. Mains.
 - * Adequate no. of patch cords stackable from rear both ends 4mm spring loaded plug length ½ metre.
 - * Good Quality, reliable terminal/sockets are provided at appropriate places on panel for connections /observation of waveforms.
 - * Strongly supported by detailed Operating Instructions, giving details of Object, Theory, Design procedures, Report Suggestions and Book References.

Activation Energy of a Thermistor

Order Code - 36300



Experimental Training Board has been designed specifically to determine the activation energy of a thermistor and to determine the material constant of the thermistor material.

The board is absolutely self contained and requires no other apparatus. Practical experience on this board carries great educative value for Science and

Engineering Students.

Object:

01. To determine the activation energy of a thermistor.
02. To determine the material constant of the thermistor material.

Features:

The board consists of the following built-in parts :

01. 1V, 2V and 5V D.C. at 10mA, Power Supply selectable by band switch.
 02. Digital Milliammeter, 3½ digits having range 2mA D.C.
 03. Oven, Electrically heated, for the purpose of varying the temperature of the thermistor.
 04. Thermistor with leads.
 05. Thermometer 0-110 °C.
 06. Mains ON/OFF switch and Fuse.
- * The unit is operative on 230V \pm 10% at 50Hz A.C. Mains.
 - * Strongly supported by detailed Operating Instructions, giving details of Object, Theory, Design procedures, Report Suggestions and Book References.

Frequency To Voltage Converter

Order Code - 36301

Experimental Training Board has been designed specifically for the study Frequency to Voltage Conversion. With the help of this training board one can know about different aspect and need for such converter and its characteristics.

Practical experience on this board carries great educative value for Science and Engineering Students.

Object:

To verify that the output voltage varies in accordance with the input frequency.

Features:

The board consists of the following built-in parts :

01. \pm 15V D.C. at 100mA IC regulated power supply internally connected.
 02. Frequency to voltage converter IC.
 03. Potentiometer to calibrate the output voltage according to input frequency.
 04. Adequate no. of other electronic components.
 05. Mains ON/OFF switch, fuse and jewel light.
- * The unit is operative on 230V \pm 10% at 50Hz A.C. Mains.
 - * Adequate no. of patch cords stackable from rear both ends 4mm spring loaded plug length ½ metre.
 - * Good Quality, reliable terminal/sockets are provided at appropriate places on panel for connections /observation of waveforms.
 - * Strongly supported by detailed Operating Instructions, giving details of Object, Theory, Design procedures, Report Suggestions and Book References.
 - * Weight : 3 Kg. (Approx.)
 - * Dimension : W 340 x H 110 x D 210

Other Apparatus Required:

01. Function Generator
02. Digital Multimeter (3¾ digit)
03. Cathode Ray Oscilloscope 20MHz.

Class A, B, C & AB Amplifier

Order Code - 36302



Experimental Training Board has been designed specifically to study class A, class B, class C & class AB amplifier. The input signal has 2 Vpp at 1KHz frequency. It is internally generated. The board is self contained and required no other components except CRO. Practical experience on this board carries great educative value for Science and Engineering Students.

Object:

To study :

01. Class A amplifier.
02. Class B amplifier.
03. Class C amplifier.
04. Class AB amplifier.

Features:

The board consists of the following built-in parts :

01. $\pm 12V$ D.C. at 100mA IC regulated power supply internally connected.
02. NPN Transistor.
03. Built in 1KHz sinewave osc. having output 1.5Vpp.
04. Two potentiometers to control +Ve & -Ve voltages.
05. Adequate no. of other electronic components.
06. Mains ON/OFF switch, fuse and jewel light.
- * The unit is operative on 230V $\pm 10\%$ at 50Hz A.C. Mains.
- * Adequate no. of patch cords stackable from rear both ends 4mm spring loaded plug length $\frac{1}{2}$ metre.
- * Good Quality, reliable terminal/sockets are provided at appropriate places on panel for connections/observation of waveforms.
- * Strongly supported by detailed Operating Instructions, giving details of Object, Theory, Design procedures, Report Suggestions and Book References.

Op-Amp Used As Scalar, Summer and Voltage Follower

Order Code - 36303

Experimental Training Board has been designed specifically for the study of Scaling, Summer and Voltage follower using OP-AMP ICs 741. Practical experience on this board carries great educative value for Science and Engineering Students.

Object:

01. To study Scaling Amplifier, configured in such a way so that any type of transfer function i.e. Direct or Inverse with D.C. Offset (+ve or -ve) can be scaled.
02. To study Summing amplifier or adder.
03. To study Voltage follower or Buffer Amplifier.

Features:

The board consists of the following built-in parts :

01. $\pm 15V$ D.C. at 50mA, IC regulated power supply internally connected.
02. Three 0-10V D.C. at 50mA, continuously variable

power supplies.

03. Two DPM $3\frac{1}{2}$ digits to read 0-20V.
04. Two OP-AMP ICs 741.
05. Two Potentiometers.
06. Adequate no. of Electronic Components.
07. Mains ON/OFF switch, Fuse and Jewel light.
- * The unit is operative on 230V $\pm 10\%$ at 50Hz A.C. Mains.
- * Adequate no. of patch cords stackable 4 mm spring loaded plug length $\frac{1}{2}$ meter.
- * Good Quality, reliable terminal/sockets are provided at appropriate places on panel for connections & observation of waveforms.
- * Strongly supported by detailed Operating Instructions, giving details of Object, Theory, Design procedures, Report Suggestions and Book References.
- * Weight : 5 Kg. (Approx.)
- * Dimension : W 412 x H 150 x D 310

Other Apparatus Required:

01. Digital Multimeter ($3\frac{3}{4}$ digit)
02. Audio Frequency sine wave generator
03. Cathode Ray Oscilloscope 20MHz

Op-Amp as Differentiator and Integrator

Order Code - 36304



Experimental Training Board has been designed specifically for the study of OP-AMP IC's applications. This training board covers Integrator and Differentiator application of operational amplifiers (IC-741) and makes the student familiar with it. Practical experience on this board carries great educative value for Science and Engineering Students.

Object:

To study the following applications of Op-Amp 741 :

01. Integrating Amplifier for DC input signals.
02. Integrating Amplifier for AC input signals.
03. Differentiator Amplifier.
04. Non-inverting differentiator.

Features:

The board consists of the following built-in parts :

01. $\pm 15V$ D.C. at 100mA, IC Regulated Power Supply.
02. OP-AMP IC 741.
03. Square Wave Generator of 1 KHz, using IC.
03. Adequate no. of other electronic components.
04. Mains ON/OFF switch, Fuse and Jewel light.
- * The unit is operative on 230V $\pm 10\%$ at 50Hz A.C. Mains.
- * Adequate no. of patch cords stackable 4 mm spring loaded plug length $\frac{1}{2}$ meter.
- * Good Quality, reliable terminal/sockets are provided at appropriate places on panel for connections & observation of waveforms.
- * Strongly supported by detailed Operating Instructions, giving details of Object, Theory, Design procedures, Report Suggestions and Book References.

Other Apparatus Required:

01. Digital Multimeter ($3\frac{3}{4}$ digit)

- * Cathode Ray Oscilloscope 20MHz

Study of Op-Amp (Input-Bias Current, Output-Offset Voltage & Slew Rate)

Order Code - 36305

Experimental Training Board has been designed specifically for the study of Input-bias current, output-offset voltage & slew rate.

Practical experience on this board carries great educative value for Science and Engineering Students.

Object:

To study the following experiments :

01. To measure input-bias current.
02. To measure output-offset voltage.
03. To measure slew rate.

Features:

The board consists of the following built-in parts :

01. $\pm 12V$ D.C. at 100mA, IC Regulated Power Supply.
02. OP-AMP IC 741.
03. Two SPDT switches.
04. Potentiometer.
05. Adequate no. of other electronic components.
06. Mains ON/OFF switch, Fuse and Jewel light.
- * The unit is operative on 230V $\pm 10\%$ at 50Hz A.C. Mains.
- * Adequate no. of patch cords stackable 4 mm spring loaded plug length $\frac{1}{2}$ meter.
- * Good Quality, reliable terminal/sockets are provided at appropriate places on panel for connections & observation of waveforms.
- * Strongly supported by detailed Operating Instructions, giving details of Object, Theory, Design procedures, Report Suggestions and Book References.

Other Apparatus Required:

01. Sine Square Wave Oscillator
02. Digital Multimeter (3 $\frac{3}{4}$ digit)
03. A.C. Millivoltmeter
04. Cathode Ray Oscilloscope 20MHz

Instrumentation Amplifier

Order Code - 36306

Instrumentation Amplifier trainer has been designed specifically for the study of differential - input of Instrumentation Amplifier in a closed loop and it differs fundamentally from the standard OP-AMP.

Practical experience on this board carries great educative value for Science and Engineering Students.

Object:

Test the performance & characteristics of an Instrumentation Amplifier circuit.

Features:

The board consists of the following built in parts :

01. Two independent Instrumentation Amplifiers in a single Training Board.
02. Programmable - gain Amplifier, with an internal high precision feed back network.
03. It has high common - mode - rejection ratio (CMRR).

04. $\pm 12V$ DC at 100mA IC Regulated Power Supply internally connected.
05. Six nos. of 10 turns preset for adjustment of Offset, Gain and CMMR
06. Adequate no. of other electronic components.
07. Main ON/OFF switch, fuse and LED.
- * The Unit is operative on 230V, $\pm 10\%$ at 50Hz A.C. mains.
- * Adequate no. of patch cords stackable 2mm spring loaded plug length $\frac{1}{2}$ metre.
- * Good quality, reliable terminals/Sockets are provided at appropriate places on panel for connections/observations.
- * Strongly supported by detailed Operating Instructions, giving details of Object, Theory, Design procedures, Report Suggestions and Book References.

Other Apparatus Required:

01. Digital Multimeter
02. Function Generator
03. Dual Trace Cathode Ray Oscilloscope 20MHz.

Phase and Frequency Determination of Electrical Signals Using a Cro (Lissajous Figures)

Order Code - 36307

Experimental Set-Up has been designed specifically for Phase and frequency determination of electrical signals using a CRO. The set up is complete in all respect and requires no other apparatus.

Practical experience on this set up carries great educative value for Science and Engineering Students.

Object:

To study analog CRO, Measurement of time period, amplitude, frequency and phase angle using Lissajous Figures.

01. Study of CRO.
02. Measurement of time period.
03. Measurement of amplitude.
04. Measurement of frequency using Lissajous Figures.
05. Measurement of phase angle using Lissajous Figures.

Features:

The board consists of following built in parts :

01. Known frequency 50Hz (3VAC at 50mA).
02. One Inductor.
03. One Capacitor.
04. Resistance selector switch to select different resistance.
05. Mains ON/OFF switch, Fuse and Jewel light.
- * Adequate no. of patch cords stackable 4mm spring loaded plug length $\frac{1}{2}$ metre.
- * Good Quality, reliable terminal/sockets are provided at appropriate places on panel for connections/observation of waveforms.
- * Strongly supported by detailed Operating Instructions, giving details of Object, Theory, Design procedures, Report Suggestions and Book References.

Other Apparatus Required:

01. Audio Sine Wave Generator
02. Dual Slope Cathode Ray Oscilloscope 20MHz.

Transistor as a Switch

Order Code - 36308

Has been designed specifically to study switching characteristics of a transistor and its application. Practical experience on this board carries great educative value for Science and Engineering Students.

Object:

To study transfer characteristics of a transistor :

01. Delay time
02. Rise time
03. On time
04. Storage time
05. Fall time
06. Off time

Transistor as a switch application.

Feature:

The board consists of the following built-in parts :

01. 12 VDC at 100 mA, IC Regulated Power Supply.
02. 0-5 VDC at 100 mA, Variable Regulated Power Supply.
03. LED to give indication whether relay is energised or not.
04. Two NPN Transistors.
05. Adequate no. of other Electronic Components.
06. Mains ON/OFF switch, Fuse & Jewel light.
- * The unit is operative on 230V $\pm 10\%$ at 50Hz AC Mains.
- * Adequate no. of patch cords stackable 4mm spring loaded plug length 1/2 metre.
- * Good Quality, reliable terminal/sockets are provided at appropriate places on panel for connections/ observation of waveforms.
- * Strongly supported by detailed Operating Instructions, giving details of Object, Theory, Design procedures, Report Suggestions and Book References.

Other Apparatus Required:

01. Sine Square Wave Oscillator
02. Dual Trace CRO 20MHz.

Application of Thermistors Type PTC & NTC

Order Code - 36309

Experimental Training Board has been designed specifically to study application of Thermistors Type PTC & NTC). Practical experience on this board carries great educative value for Science and Engineering Students.

Object:

01. To perform practical Temperature / Fire alarm with NTC Thermistor.
02. To perform practical over Temperature control alarm with NTC Thermistor.
03. To perform practical Temperature / Fire alarm with PTC Thermistor.
04. To perform practical under Temperature alarm with PTC Thermistor.

Features:

The board consists of the following built-in parts :

01. ± 12 V DC at 100 mA, IC Regulated Power Supply.
02. 0.8 V DC at 10 mA, Regulated Power Supply.
03. Five Op-Amp ICs.

04. Relay of 12 V DC having 2 Change - over
05. 6 V bulb for indication of relay energise / Alarm indication.
06. NTC Thermistors with 5 pins male connector.
07. PTC Thermistors with 3 pins female connector.
08. Two NPN transistors.
09. Two PNP Transistor.
10. 2 pin socket to connect load (100 W bulb).
11. 100 watt bulb with holder and 2 pin plug top.
12. Adequate no. of other electronic components.
13. Mains ON/OFF switch, Fuse and Jewel light.
- * The unit is operative on 230V $\pm 10\%$ at 50Hz A.C. Mains.
- * Adequate no. of patch cords stackable from rear both ends 4mm spring loaded plug length 1/2 metre.
- * Good Quality, reliable terminal/sockets are provided at appropriate places on panel for connections /observation of waveforms.

Other Apparatus Required:

01. Hot Plate

Feed Back Amplifiers (four Types Using Transistors)

Order Code - 36310



Experimental Training Board has been designed specifically for study current series, current shunt, voltage series and voltage shunt Feed Back Amplifier using Transistors.

Practical experience on this board carries great educative value for Science and Engineering Students.

Object:

To Design, setup and study the following Feed back Amplifiers.

01. Current series Feed Back Amplifier.
02. Voltage series Feed Back Amplifier.
03. Voltage shunt Feed Back Amplifier.
04. Current shunt Feed Back Amplifier.

Feature:

The board consists of the following built-in parts :

01. 12V DC at 100 mA, IC Regulated Power Supply.
02. Four independent Transistors Feed Back Amplifiers.
03. Four toggle switches to select feed back.
04. Six NPN transistors.
05. Adequate no. of Electronic Components.
06. Mains ON/OFF switch, Fuse & Jewel light.
- * The unit is operative on 230V $\pm 10\%$ at 50Hz AC Mains.
- * Adequate no. of patch cords stackable 4mm spring loaded plug length 1/2 metre.
- * Good Quality, reliable terminal/sockets are provided at appropriate places on panel for connections/ observation of waveforms.
- * Strongly supported by detailed Operating Instructions, giving details of Object, Theory, Design procedures, Report Suggestions and Book References.

Feed Back Amplifier (4 Types) Using Fet & Transistor

Order Code - 36311



Experimental Training Board has been designed specifically for study current series, current shunt, voltage series and voltage shunt Feed Back Amplifier using Transistor and FET.

Practical experience on this board carries great educative value for Science and Engineering Students.

Object:

To study the following Feed back Amplifiers.

01. Voltage shunt Feed back Amplifiers using Transistor.
02. Current shunt Feet back Amplifier using Transistor.
03. Voltage series Feed back Amplifier using FET.
04. Current series Feed back Amplifier using FET.

Feature:

The board is having following built - in parts.

01. Four independent Transistors and FET Feed back Amplifiers.
02. 12V DC at 100 mA, IC Regulated Power Supply internally connected.
03. Four toggle switches to select feed back.
04. Three NPN transistors.
05. Two FETs.
06. Adequate no. of Electronic Components.
07. Mains ON/OFF switch, Fuse & Jewel light.
- * The unit is operative on 230V $\pm 10\%$ at 50Hz AC Mains.
- * Good Quality, reliable terminal/sockets are provided at appropriate places on panel for connections/ observation of waveforms.
- * Strongly supported by detailed Operating Instructions, giving details of Object, Theory, Design procedures, Report Suggestions and Book References.

Wien Bridge Oscillator Using JFET

Order Code - 36312



The experimental set up has been designed specially for the study of Wien Bridge Audio Oscillator using JFET. The Training board helps us to under stand the utilization of Audio OSC and obtain oscillation at different frequencies.

Practical Experience on these boards carries great educative value for Science and Engineering students.

Object:

To design and setup a Wien Bridge Oscillator using JFET to generate a sinusoidal signal of three frequencies at 3V . PP

Feature:

The board consists of the following built in parts :

01. 12V DC at 100 mA, IC Regulated Power Supply

internally connected.

02. Potentiometer to vary the amplitude.
03. Two JEET.
04. Adequate no. of electronic components.
05. Mains ON/OFF switch, Fuse & Jewel light.
- * The unit is operative on 230V $\pm 10\%$ at 50Hz AC Mains.
- * Adequate no. of patch cords stackable 4mm spring loaded plug length 1/2 metre.
- * Good Quality, reliable terminal/sockets are provided at appropriate places on panel for connections/ observation of waveforms.
- * Strongly supported by detailed Operating Instructions, giving details of Object Theory, Design procedures, Report Suggestions and Book References.

Measurement of Inductance by Hay's Bridge

Order Code - 36313



Experimental Training Board has been designed specifically to measure the value of unknown inductance by Hay's bridge.

Practical experience on this board carries great educative value for Science and Engineering students.

Object:

To Measure the Value of Unknown Inductance by Hay's Bridge.

Features:

The board consists of the following built-in parts :

01. Hay's Bridge circuit with arm values
02. $\pm 12V$ DC at 100 mA, IC Regulated Power Supply internally connected.
03. 1 KHz Sinewave oscillator Output 0 - 15 Vpp.
04. Audio Amplifier and Speaker for Null detection.
05. Three Unknown Value of Inductor Selectable by a band Switch.
06. Potentiometer 10 turn for Selecting desired Resistance Value.
07. Potentiometer for balancing the bridge.
08. Adequate no. of electronic components.
09. Mains ON/OFF switch, Fuse & Jewel light.
- * The unit is operative on 230V $\pm 10\%$ at 50Hz AC Mains.
- * Adequate no. of patch cords stackable 4mm spring loaded plug length 1/2 meter.
- * Good quality, reliable terminals / sockets are provided at appropriate places on panel for connections / observation & waveforms.
- * Strongly supported by detailed operating Instructions, giving details of object, theory, design procedures, report suggestions and book References.

Measurement of Unknown Capacitance By Schering Bridge

Order Code - 36314



Experimental Training Board has been designed specifically to Measure the Value of unknown Capacitance by Schering Bridge.

Practical experience on this board carries great educative value for Science and Engineering Students.

Object:

To Measure the Value of Unknown Capacitance by Schering Bridge.

Feature:

The board consists of the following built-in parts :

01. Schering Bridge circuit with arms values.
02. ± 12 VDC at 100 mA, IC Regulated Power Supply internally connected.
03. 1KHz Sinewave oscillator having output 0-15 Vpp.
04. Audio amplifier and speaker for null detector.
05. Three unknown value of capacitors selectable by a band switch.
06. Potentiometer for balancing the bridge.
07. Band switch to select one from six different values of resistance.
08. Adequate no. of other Electronic Components.
09. Mains ON/OFF switch, Fuse & Jewel light.
- * The unit is operative on 230V $\pm 10\%$ at 50Hz AC Mains.
- * Adequate no. of patch cords stackable 4mm spring loaded plug length 1/2 metre.
- * Good Quality, reliable terminal/sockets are provided at appropriate places on panel for connections/ observation of waveforms.
- * Strongly supported by detailed Operating Instructions, giving details of Object Theory, Design procedures, Report Suggestions and Book References.

Measurement of Self Inductance by Owen's Bridge

Order Code - 36315



The experimental set up has been designed specially for the study of To Measure the Value of Unknown Self Inductance.

Practical Experience on these boards carries great educative value for Science and Engineering students.

Object:

To Measure the Value of Unknown Self Inductance by Owen's Bridge

Feature:

The board consists of the following built in parts :

01. Owen's Bridge circuit with arm values
02. ± 15 V DC at 100 mA, IC Regulated Power Supply internally connected.
03. 1 KHz Sinewave oscillator Output 0 - 15 Vpp.
04. Audio Amplifier and Speaker for Null detection.
05. Three Unknown Value of Inductor Selectable by a band Switch.
06. Potentiometer 1K - 10 turn for Selecting desired Resistance Value.
07. Potentiometer for balancing the bridge.
08. Adequate no. of electronic components.

09. Mains ON/OFF switch, Fuse & Jewel light.

- * The unit is operative on 230V $\pm 10\%$ at 50Hz AC Mains.
- * Adequate no. of patch cords stackable 4mm spring loaded plug length 1/2 metre.
- * Good Quality, reliable terminal/sockets are provided at appropriate places on panel for connections/ observation of waveforms.
- * Strongly supported by detailed Operating Instructions, giving details of Object Theory, Design procedures, Report Suggestions and Book References.

Voltmeter Characteristics : Ohms Per Volt

Order Code - 36316



Experimental Training Board has been designed specifically for the study of Voltmeter Characteristics : Ohms per volt. It is actual practice to specify the sensitivity of a voltmeter in terms of ohms per volt. Practical experience on this board carries great educative value for Science and Engineering Students.

Object:

Study of Voltmeter characteristics : Ohms per volt.

Features:

The board consists of the following built-in parts :

01. Voltmeter 65mm rectangular dial of 1V range, having resistance of 1K $\pm 10\%$ and full scale deflection current is 1mA.
02. IC regulated variable DC power supply of 0-20Volt at 100mA.
03. Necessary resistance.
04. Mains ON/OFF switch, Fuse and Jewel light.
- * The unit is operative on 230V $\pm 10\%$ at 50Hz A.C. Mains.
- * Adequate no. of patch cords stackable 4 mm spring loaded plug length 1/2 meter.
- * Good Quality, reliable terminal/sockets are provided at appropriate places on panel for connections & observation.
- * Strongly supported by detailed Operating Instructions, giving details of Object, Theory, Design procedures, Report Suggestions and Book References.

Wheatstone Bridge

Order Code - 36317



Experimental Training Board has been designed specifically for the study of Wheatstone Bridge. Using this bridge the value of unknown resistor can be found. The board is absolutely self contained and requires no other apparatus.

Practical experience on this board carries great educative value for science and engineering students.

Object:

01. To study Wheatstone Bridge
02. To measure value of unknown resistance.

Features:

The board consists of the following built in parts:

01. +5V D.C. At 100mA IC regulated power supply internally connected.
02. Galvanometer, 65mm rectangular dial to read 30-0-30.
03. Six decade resistance of different range.
04. Adequate. no. of other electronic components.
05. Mains ON/OFF switch, Fuse and Jewel Light.
- * The unit is operative on 230V \pm 10% at 50Hz A.C. Mains.
- * Adequate no. of patch cords stackable from rear both ends 4mm spring loaded plug length $\frac{1}{2}$ metre.
- * Good Quality, reliable terminal/sockets are provided at appropriate places on panel for connections/ observation of waveforms.
- * Strongly supported by detailed Operating Instructions, giving details of Object, Theory, Design procedures, Report Suggestions and Book References.

Op-Amp Characteristics

Order Code - 36318

Experimental Training Board has been designed specifically for the study of OP-AMP CHARACTERISTICS Ics 741. This Training Board has been an ideal teaching aid for different types of Electronic Circuits by using CHARACTERISTICS OF OP-AMP. Practical experience on this board carries great educative value for Science and Engineering Students.

Object:

01. Nullify the offset.
02. Measurement of slew rate.
03. Inverting amplifier with single input.
04. Non-inverting amplifier with single input.
05. Adder in inverting & non-inverting configuration with two and three inputs respectively.
06. Averaging amplifier in non-inverting mode with maximum 3 inputs.
07. Averaging amplifier in inverting mode with maximum 3 inputs.
08. Difference amplifier.
09. Subtractor.
10. Scaling amplifier in inverting and non-inverting mode.
11. Op-amp as voltage follower.
12. Op-amp as comparator.
13. Schmitt trigger.
14. Differentiator.
15. Integrator.
16. P - I action. (Proportional Integration Action.)

Features:

The board consists of the following built-in parts :

01. \pm 15V D.C. at 50mA, IC regulated power supply internally connected.
02. Two 0-5V D.C. at 50mA, continuously variable power supplies.
03. One 0-10V D.C. at 50mA, continuously variable power supplies.
04. One negative 10V D.C. at 50mA, IC regulated

power supplies.

05. One DPM 3 $\frac{1}{2}$ digits to read 0-20V.
06. Three OP-AMP ICs 741.
07. One Potentiometers.
08. Adequate no. of Electronic Components.
09. Mains ON/OFF switch & Fuse.
- * The unit is operative on 230V \pm 10% at 50Hz A.C. Mains.
- * Adequate no. of patch cords stackable 4 mm spring loaded plug length $\frac{1}{2}$ meter.
- * Good Quality, reliable terminal/sockets are provided at appropriate places on panel for connections & observation of waveforms.
- * Strongly supported by detailed Operating Instructions, giving details of Object, Theory, Design procedures, Report Suggestions and Book References.

Other Apparatus Required:

01. Function Generator
02. Cathode Ray Oscilloscope 20MHz

Put Characteristics & Relaxation Oscillator

Order Code - 36319

Experimental Training Board has been designed specifically for the study of PUT characteristics & its relaxation oscillator.

Practical experience on this board carries great educative value for science and engineering students.

Object:

01. To draw the V-I characteristics of PUT.
02. To study PUT relaxation oscillator.

Features:

The board consists of the following built in parts:

01. 0-30V D.C. At 200mA, IC regulated power supply.
02. 0-30V D.C. At 100mA, IC regulated power supply.
03. DC voltmeter 65mm rectangular dial with range of 50V.
04. DC ammeter 65mm rectangular dial with range of 100mA.
05. Adequate no. of other electronic components.
06. Mains ON/OFF Switch with indicator and Fuse.
- * The unit is operative on 230V \pm 10% at 50Hz A.C. Mains.
- * Adequate no. of patch cords stackable from rear both ends 4mm spring loaded plug length $\frac{1}{2}$ metre.
- * Quality, reliable terminal/sockets are provided at appropriate places on panel for connections/ observation of waveforms.
- * Strongly supported by detailed Operating Instructions, giving details of Object, Theory, Design procedures, Report Suggestions and Book References.

Other Apparatus Required :

01. Cathode Ray Oscilloscope.

Opto Electronic Applications Using 741 and 555

Order Code - 36320

Experimental Training Board has been designed specifically for the study of Op-Amp, Timer and their Application with many sensor as photo diode. Photo transistor, LDR, thermistor, NTC and PTC. The

capabilities of this trainer extend far beyond the experiments described. Although only a finite number of experiments have been described yet other circuits as per individuals requirements can also be designed using the available components and power supplies. Practical experience on this board carries great educative value for Science and Engineering Students.

Object:

Study of Timer IC-555 and Application

01. Bistable Multi vibrator using IC 555.
02. Astable Multi vibrator using IC 555.
03. Astable Multi vibrator with duty cycle more than 50%
04. Astable Multivibrator Having Duty Cycle of less than 50%.
05. Astable Multi vibrator with duty cycle Variable From 0 to 100% & Freq. constant
06. Mono stable Multi vibrator using IC 555.
07. Timer Delay Relay Using 555.
08. Electronic Timer Using IC-555
09. Burglar Alarm Using Timer IC-555 & Breaking of wire and LDR.
10. To Study Burglar Alarm Using Timer IC-555 Breaking of Wire & Photo Transistor
11. Burglar Alarm Using Timer IC-555 and Photo Diode.

Study of Operational Amplifier and its Applications.

12. Inverter Amplifier.
13. Non Inverter Amplifier.
14. Inverting A.C. Amplifier.
15. Non Inverting A.C. Amplifier.
16. High Input Impedance Inverting Amplifier
17. High Input Impedance Non Inverting Amplifier
18. LED Driver using 741 OPamp.
19. Lamp Drivers using 741 OPamp.
20. Temperature ON- OFF Controller With Thermistor NTC.
21. Temperature ON-OFF Controller With Thermistor Using PTC.
22. Burglar Alarm using OPamp 741 and LDR.
23. Photo Diode.
24. Photo Transistor.

Features:

The board consists of the following built in parts :

01. $\pm 12V$ D.C. at 200mA power supply
 02. Thermistor NTC & PTC on Board.
 03. Photo Diode
 04. Photo Transistor
 05. LDR.
 06. Two LED With Suitable Resistor For Visual Indication
 07. 12V Relay For Multi Operating. 1C/O
 08. Two IC OPamp (LM-741).
 09. The Timer IC (NE-555).
 10. Three Transistor NPN (SL-100& BC-107,) and PNP (SK-100).
 11. Five Potentiometers.(100E,1K,10K,47K,1M).
 12. Two Pulser Switch.
 13. One Pulser Switch With lock Feature.
 14. 19 Resistor of Different Values.
 15. 12 Capacitor of Different Values and Zener Diode.
 16. 3 Switching Diode.
 17. Mains ON / OFF Switch, fuse and Neon Indicators are Provided.
- * The unit is operative on 230V $\pm 10\%$ at 50Hz A.C.

Mains.

- * Adequate no. of patch cords stack able from rear both ends 2mm spring loaded plug length $\frac{1}{2}$ meter.
- * Good Quality, reliable terminal/sockets are provided at appropriate places on panel for connections & observation of waveforms.
- * Strongly supported by detailed Operating Instructions, giving details of Object, Theory, Design procedures, Report Suggestions and Book References.

Other Apparatus Required:

01. CRO.
02. Multimeter.
03. Solder Iron for Heating.

Zener Diode (Characteristics & Temperature Effect)

Order Code - 36321

Experimental Training Board has been designed specifically for plotting the forward and reverse bias characteristics of a Germanium semiconductor Diode and Zener Diode and study of temperature coefficient of Zener Diode. The board is absolutely self contained and requires no other apparatus. Practical experience on this board carries great educative value for Science and Engineering Students.

Object:

1. To study and plot the forward & reverse bias characteristics of a Germanium semiconductor Diode.
2. To study and plot the forward & reverse bias (breakdown) characteristics of a Zener Diode.
3. To study the Temperature Coefficient of Zener Diode and plot Power Rating curves.

Features:

The board consists of the following built-in parts:

1. 0-10V D.C. at 20mA, continuously variable regulated Power Supply with low ripple & hum and integral current limiting resistor.
 2. Digital Voltmeter 3 $\frac{1}{2}$ digits having ranges of 20V.
 3. Digital Miliammeter 3 $\frac{1}{2}$ digits having ranges of 20mA.
 4. A Germanium semiconductor Diode mounted behind the panel.
 5. A Zener Diode mounted behind the panel.
 6. Adequate no. of other electronic components.
 7. Oven electrically heated, for the purpose of varying the temperature of Zener diode.
 8. Thermometer 0-110°C
 9. Mains ON/OFF switch, Fuse and Jewel light.
- * This unit is operating on 230V $\pm 10\%$ at 50Hz A.C. Mains.
 - * Adequate no. of patch cords stackable from rear both ends 4mm spring loaded plug length $\frac{1}{2}$ meter.
 - * Good Quality, reliable terminal/sockets are provided at appropriate places on panel for connections/observation of waveforms.
 - * Weight : 3 Kg. (Approx.)
 - * Dimension : W 340 x H 110 x D210

Transformer Winding Practice

Order Code - 36322

Experiment training Boards have been designed

specifically to study Transformers designing and winding.

Practical experience on this board carries great educative value for Science and Engineering Students.

Object:

1. To design a step up/step down transformer.
2. To construct and study the step up/step down transformer.

Specifications and Features:

This kit consists of the following parts:

1. Bobbins
2. E-I core plates
3. Winding wires:

Length (m.)	SWG	Max current (amp.)
5	21	1.000
5	23	.542
5	27	.253
5	31	.126
5	36	.054
4. Insulation Paper
5. Varnish material
6. Nuts and Bolts

Other Apparatus required:

1. Manual Coil Winding Machine
2. Digital Multimeter
3. Utensils

Audio Amplifier Using IC LM-380

Order Code - 36323

Experimental Training Board has been designed specifically for the study of Audio Amplifier using LM-380.

Practical experience on this board carries great educative value for Science and Engineering student.

Object:

01. To measure the voltage gain of the audio amplifier.
02. To plot the frequency response characteristics of audio amplifier.
03. To find out the input impedance.
04. To find out the output impedance.
05. To find out the current gain.
06. To find out the power gain.

Features:

The board consist of following built in parts:

01. 15V dc at 50mA, IC regulated power supply internally connected.
02. Audio power amplifier IC LM-380.
03. Adequate no. other electronic components.
04. Mains ON/OFF switch, Fuse and Jewel light.
- * The unit is operating on 230V \pm 10V% at 50Hz A.C. Mains.
- * Adequate no. of patch cords stackable form rear both ends 4mm spring loaded plug length $\frac{1}{2}$ meter.
- * Good quality, reliable terminal/ sockets are provided at appropriate places on panel for connections/ observation of waveform.

Other Apparatus Required:

01. Audio Frequency Generator
02. Cathode Ray Oscilloscope 20MHz

Logarithmic Amplifiers Design & Test (using IC-741OpM)

Order Code - 36324

Experimental Training Board has been designed specifically to study the Logarithmic Amplifiers Design & Test (using- The board is absolutely self contained and requires no other apparatus.

Practical experience on this board carries great educative value for Science and Engineering Students.

Object:

To Design build and test a Logarithmic Amplifier.

Features:

The board consists of the following built-in parts :

01. 0-10V D.C. at 50mA, continuously variable Power Supply
02. \pm 15VDCat 50mA, IC Regulated power supply
03. Digital Voltmeter DC $3\frac{1}{2}$ Digit Having Dual range of 200mV/ 20V.
04. Adequate no. of other electronic components
05. Mains ON/OFF switch, Fuse and Jewel light.
- * The unit is operative on 230V \pm 10% at 50Hz A.C. Mains.
- * Adequate no. of patch cords stackable from rear both ends 4mmspring loaded plug, length $\frac{1}{2}$ metre.
- * Good Quality, reliable terminal/sockets are provided at appropriate places on panel for connections /observation of waveforms.
- * Strongly supported by detailed Operating Instructions, giving details of Object, Theory, Design procedures, Report Suggestions and Book References.
- * Cathode Ray Oscilloscope 20MHz

Other apparatus required:

01. Cathode Ray Oscilloscope 20MHz

Basic Electronic Trainer 6set

Order Code - 36325



36325.1 - BASIC ELECTRONIC TRAINER (Digital Gates)

has been designed specifically to study the principle of and NAND, NOT, OR, NOR, & EXOR gate. The training board offers a new method of training student in the basic theory of digital circuit and make them familiar with basic experiment in digital circuit.

Practical experience on this board carries great educative value for Science and Engineering Students.

OBJECT:

Study of basic gates & verification of their truth tables (AND, NAND, NOT, OR, NOR & EX-OR Gate).

Features:

The board consists of the following built-in parts:

01. +5VDC 100mA Adopter
02. NAND Gate
03. NOT Gate
04. OR Gate
05. NOR Gate

06. EX-OR Gate
07. Switches for logic selection
08. LED's for visual indication of status.
09. The unit is operative on 230V±10% at 50Hz A.C. Mains.

36325.2 - BASIC ELECTRONIC TRAINER-2 (Ohm's Law Characteristics) Experimental Training Board has been designed specifically for the verification of Ohm's Law & to study the series and parallel combination of Resistance network. This training board is quite useful for imparting the basic knowledge of voltage and current distribution and the effect of series parallel circuit.

Object:

Verification of ohm's Law.

Features:

The board consists of the following built-in parts:

01. 0-20 V D.C. at 50mA, continuously variable regulated Power Supply.
02. D.C. Voltmeter, 0-20V
03. D.C. Current meter 0-200mA
04. Adequate No. of other electronic components.
05. Mains ON/OFF switch, Fuse and Jewel light.

36325.3 - BASIC ELECTRONIC TRAINER

(Operational Amplifier) has been designed specifically for the study of OP-AMP IC.

List Of Experiments:

01. Inverting Amplifier
02. Non-inverting Amplifier
03. Voltage Follower (unity Gain Buffer Amplifier)
04. Inverting Summing Amplifier
05. Non-inverting Summing Amplifier
06. Subtractor & Differential Amplifier
07. Division By A Constant
08. Square Wave Generator
09. Off-set Adjustment In Op-amp Circuits
 - 9.1 For Inverting Amplifier
 - 9.2 For Non-inverting Amplifier
 - 9.3 For Voltage Follower
10. Measurement Of Input Offset Voltage (vio)

Features:

01. ± 15V DC at 100mA IC Regulated power supply
02. Two 0-5V at 20mA continuously variable power supply
03. One Op-Amp IC-741
04. DC Voltmeter 0-5V
05. DC Voltmeter 0-20V
06. Potentiometer 10K
07. 10 resistance and 1 Capacitor
08. Mains ON/OFF switch fuse Neon Indicator

36325.4 - BASIC ELECTRONIC TRAINER (Zener Diode Characteristics)

Experimental Training Board has been designed specifically for plotting the forward and reverse bias characteristics of a Germanium semiconductor Diode, and a Zener Diode. The board is absolutely self contained and requires no other apparatus.

Object:

To Study And Plot The Forward & Reverse Bias

(breakdown) Characteristics of a Zener Diode.

36325.5 - BASIC ELECTRONIC TRAINER (PN Junction Diode Characteristics) Experimental Training Board has been designed specifically for plotting the forward and reverse bias characteristics of a Germanium semiconductor Diode, and a Zener Diode.

Object:

To study and plot the forward & reverse bias characteristics of a Germanium semiconductor Diode.

Features:

The board consists of the following built-in parts :

01. 0-10V DC at 100mA, continuously variable regulated Power Supply with low ripple & hum and integral current limiting resistor.
02. DC Voltmeter, Dual range of 1/10V
03. DC Current meter dual range 50uA/10mA
04. A Germanium semiconductor Diode mounted behind the panel.
05. A Zener Diode mounted behind the panel.
06. Adequate no. of other electronic components.
07. Mains ON/OFF switch, Fuse and Jewel light.
- * The unit is operative on 230V±10% at 50Hz A.C. Mains.

36325.6 - BASIC ELECTRONIC TRAINER (Domestic Ac Mains Supply Trainer)

is used to understand the wiring of Domestic AC mains supply. On the panel complete house wiring (after energy meter) is shown but after distribution board wiring is provided. To understand the room wiring of room 1 & room 2 are shown with dotted line on the panel. A three pin socket (5Amp) & a switch in Room 1 and two pin socket & a switch in Room 2 are provided on the panel

Power and Differential Amplifier Trainer

Order Code - 36326



Power and Differential Amplifier Trainer is a unique product has a variety of transistorized amplifiers like class B power amplifier and differential amplifier. This product has in-built DC power supply and sine wave generator which makes it useful to complete experiments without any extra assembly.

The term "Power Amplifier" is a relative term with respect to, the amount of power delivered to the load and/or sourced by the supply circuit, whereas, a "Differential Amplifier" is a type of electronic amplifier that multiplies the difference between two inputs with some constant factor.

Features:

01. In-built DC power supply
02. In-built sine wave generator
03. Compact design

Scope of Learning

- * Study of the working principle of Differential Amplifier
- * Study of the working principle of class B push-pull Amplifier

Technical Specifications:

DC power supply	: +12 V, -12 V, +5 V, -5 V
Variable DC power supply	: 0 to 1 V
Sine wave generator	
Frequency	: 800 Hz to 8 KHz
Amplitude	: 0 to 5 Vpp
Mains supply	: 230V ±10%, 50Hz
Fuse	: 350 mA, slow blow

BJT Amplifiers and Emitter Follower Trainer

Order Code - 36327



BJT Amplifiers and Emitter follower Trainer is a unique product designed to explain the role of BJT's as single-stage/multistage RC-coupled amplifiers and as common collector emitter followers.

One of the common method for coupling two stages of an amplifier is RC-coupling. RC-coupled amplifiers have the advantage of wide frequency response and relatively small cost and size. Darlington transistors are circuits that combine two bipolar transistors in a single device such that high current gain (β) is obtained and lesser space is required than that used by two discrete transistors.

Is useful for students in plotting the frequency vs. Gain response of BJTs and in the measurement of parameters such as Bandwidth, Input Impedance etc.

Scope of Learning

- * Study of the working principle of Differential Amplifier
- * Study of the working principle of class B push-pull Amplifier

Features :

01. Easy illustration of multistage amplifier and emitter follower
02. In-built sine wave generator with variable frequency and amplitude
03. In- built DC power supply

Technical Specifications

DC power supply	: +12 V, +5 V
Fuse	: 500 mA, slow blow

Sine wave generator

Frequency	: 10 Hz - 100 KHz ±10%
Amplitude	: 0 to 5 Vpp
Mains supply	: 230 V ±10%, 50

OP AMP Applications

Order Code - 36328



36328 An Operational Amplifier, usually referred to as an 'Op-Amp.' For brevity, Op-Amps are among the most widely used electronic devices today, being utilized in a vast array of consumer, industrial and scientific

devices. In present days electronics system a basic building block is the operational amplifier. The Operational amplifier is a versatile device that can be used to amplify DC input signal as well as AC input signal and used for computing mathematical function such as addition, subtraction, multiplication, integration and differentiation, and due to the ability to program these operations the name operational Amplifier stems.

36328, Op-Amp. Application platform student can study the basic mathematical operations addition, Subtraction, Integration, Differentiation, Rectification, Oscillation, Filtering, peak detection, comparison, and so on. However, an ideal operational amplifier is an extremely versatile circuit element, with a great many applications beyond mathematical operations and to understand and perform those application it is necessary to achieve better understanding of its basic application.

36328 has been divided into different independent blocks for the ease of user to understand the various application of operational amplifier. A function generator, generating Sine wave, Square wave and triangular wave, and variable DC supplies are provided on board.

Object:

01. Study and observe Op-Amp as voltage Computer
02. Study and observe Op-Amp as Zero crossing Detector
03. Study and observe Op-Amp as a phase shift oscillator and its phase shift at every RC Combination.
04. Study and observe Op-Amp as a function generator, generating square and triangle wave
05. Study and observe Op-Amp as a half wave precision rectifier
06. Study and observe Op-Amp as active second order high pass filter
07. Study and observe Op-Amp as a when bridge oscillator and its agin factor for a smooth sine wave
08. Examine the operation of colpits oscillator
09. Examine the operation of hartley oscillator

Feature:

01. Self contained easy to operate platform
02. On board function generator
03. Variable power supply
04. Functional blocks indicated on board mimic
05. Built in power supply
06. Operating manual provided
07. Compact size

Technical Specification:

The board consists of the following built in parts function generator

- | | |
|--------------------------------------|---|
| 01 Sine wave | : 1Hz -110KHz (10VPP) |
| 02 Square wave | : 1Hz -110KHz (10VPP) |
| 03 Triangle wave | : 1Hz -110KHz (8VPP) |
| 04 Pulse wav | : 1Hz -110KHz (8VPP) |
| 05 Power supplies | : 0-30V (variable) |
| 06 Power supplies | : , 5, 9, 12, 15V at 100mA |
| 07 Decade capacitor box | : 0.1uF and 1uF per step |
| 08 Decade tota step 20 capacitor box | : 0.1mH and 1mH per step total step 20 |
| 09 Experiment | : Nine individual circuits having Op-Amp, |

- resistance, capacitor, diodes, pot & ect...
- 10 Test points : 28
- 11 Power supply : 230V \pm 10%, 50Hz
- 12 Powerconsumption : 4 VA approximately
- 13 Operatingconditions : 0-40C, 85% RH
- 14 Learning material : Theory, procedure, Reference results, etc.
- 15 Dimensions (mm) : W415 x H165 x D315
- 16 Weight : 4 Kg approximately

Butter Worth Filter (1st & 2nd Order)

Order Code - 36329



39329 Experimental Training Board has been designed specifically to study. First & Second order of Low Pass Butterworth Filter for a higher cut off frequency of 1 KHz with a pass band gain of 2 & First & Second Order High Butter worth filter for Lower cut off frequency of 1 KHz with a pass band gain of 2. Practical experience on this board carries great educative value for Science and Engineering Students.

Object:

To study Butter Worth Filter (1st & 2nd Order)

01. 1st Order Low Pass Filter
02. 2nd Order Low Pass Filter
03. 1st Order High Pass Filter
04. 2nd Order High Pass Filter

Features:

The board consists of the following built-in parts :

01. \pm 12V DC at 50mA, IC regulated Power Supply internally connected.
02. Four Operational Amplifier ICs.
03. Adequate no. of other electronic components.
04. Mains ON/OFF switch and Jewel light.
- 05 The unit is operative on 230V \pm 10% at 50Hz A.C.
06. Adequate no. of patch cords stackable from rear both ends 4mm spring loaded plug length 50cm.
07. Good quality, reliable terminal/sockets are provided at appropriate places on panel for connections/observation of waveforms.
08. Strongly supported by detailed Operating Instructions, giving details of Object, Theory, Design procedures, Report Suggestions and Book References.
09. Weight : 3 Kg. (Approx.)
10. Dimension : W 340 x H 125 x D 210

Other Apparatus Required:

01. AF Generator.
02. A.C. Millivoltmeter

Transistor Amplifier Demonstrator

Order Code - 36330



36330 Experimental Training Board has been designed specifically for the study of voltage gain, frequency

response, input impedance, output impedance, current gain, Power gain of a Common Emitter (CE) Transistor Audio Amplifier.

Object:

Study of Transistor Audio Amplifier (CE) :

01. To measure the Voltage Gain.
02. To plot the Frequency Response characteristics.
03. To find out the Input Impedance.
04. To find out the Output Impedance.
05. To find out the Current Gain.
06. To find out the Power Gain.

Features:

The board consists of the following built-in parts :

01. -9V D.C. at 50mA, IC regulated Power Supply internally connected.
02. PNP transistor.
03. Adequate no. of other electronic components.
04. Mains ON/OFF switch, Fuse and Jewel light.
- * The unit is operative on 230V \pm 10% at 50Hz A.C. Mains.
- * Adequate no. of patch cords stackable from rear both ends 4mm spring loaded plug length 50cm.
- * Good Quality, reliable terminal/sockets are provided at appropriate places on panel for connections/observation of waveforms.
- * Strongly supported by detailed Operating Instructions, giving details of Object, Theory, Design procedures, Report Suggestions and Book References.
- * Weight : 3 Kg. (Approx.)
- * Dimension : W 340 x H 125 x D 210

Experimental Trainer for AC/DC Sources

Order Code - 36331



The Experimental trainer for AC/DC Sources is a useful, low cost, multipurpose, minilab for learning the basic discrete, and passive components starting from this characteristics to simple and more complex applications, The kit saves time and money in experimentation as no soldering is required to try out new circuits and components can be reused again and again. All inputs / outputs & components (bi-experimentation are terminated on 4mm brass terminations, interconnect is through 4mm patch cords. Various DC /AC regulated power supplies are built in. The kit is housed in an sturdy designed powder coated metal enclosure.

Features:

01. A very useful component trainer to show all the components used in electronics circuits / laboratory.
02. Useful, low cost. Multipurpose, minilab for linear, digital & hybrid circuits.
03. Saves time and money in experimentation as no soldering is required to try out new circuit and component can be reused.
04. All inputs / outputs & components for experimentation terminated on 4mm brass termination.

05. Interconnection through 4min stackable patch curds.
06. Various DC regulated & AC power supplies are built in.
07. Housed in an attractively designed sturdy powder coated metal box enclosure.

Technical Specifications

01. DC Power Supplies : Fixed +5V, +9V, 4 12V Power Supply.
02. AC Power Supplies : Fixed 18-9-0-9-18.
03. Fixed Resistors ; 10 nos. of fixed resistors value between 100 to 100K
04. Inductors : 5 nos. of inductors value between 10iH to mH
05. Potentiometer : 2 no. of potentiometers value of 10 K & 1M.
06. Capacitors : 5 nos. of capacitors value of .01 IA' sec .1 uf.
07. Elector Capacitors 5 nos. of electrolytic capacitors between 4.7uF to 1000uF
08. Power : 230V AC10% 5011z.
09. Manual : An instruction manual provided for 30 Basic experiments.

Synchro Transmitter & Receiver

Order Code - 36332



36332 - Synchro Transmitter and Receiver helps the users to gain invaluable knowledge about the working principle and operation of Synchro motors. Onboard AC voltmeter to measure the voltages between rotor and stator windings are also available.

Objects:

01. Study of Synchro Transmitter.
02. Study of Synchro Transmitter and Receiver pair.
03. Study of Sychro Transmitter and Receiver pair with phase difference.

Features:

01. Calibrated dials for reference and output position.
02. Switch for Transmitter and Receiver rotor supply.
03. Synchro Transmitter and Receiver rotor terminals onboard.
04. Synchro Transmitter and Receiver stator terminals onboard.
05. AC Voltmeter to measure stator and rotor voltages.
06. On/Off Touch Switch.
07. Sensitive, Linear, Stable and accurate.
08. Easy to operate.

Technical Specification:

01. Transformer Rating : 115V AC, 250mA (Rotor Winding Supply)
02. Digital Voltmeter : 0-200 V AC max.
03. Power Supply : 230V + 10%, 50Hz/60Hz
04. Weight -- : 6.800 Kg. (Approx)
03. Dimension (mm) : W415 X H165 X D315

Transient Analysis of RC/LC Circuit

Order Code - 36333



Transient Analysis of RC/LC Circuits, 36333 has been designed specifically for the transient response analysis with both DC and AC signals as input. This is useful for students to study and analyze the behavior of any circuit during the transient period. The study of transient and steady state transient of a circuit is very important as they form the building block of most electrical circuits. With this product, we can easily calculate time constant of RC circuits theoretically and practically.

Object:

01. Study the transient response of a series RC circuit and understand the time constant concept with DC power supply.
02. Study the transient response of a series RL circuit and understand the time constant concept with DC power supply.
03. Study the transient response of a series RC circuit and understand the time constant concept with square wave TTL.
04. Study the transient response of a series RL circuit and understand the time constant concept with square wave TTL.

Features:

01. Easy experimental illustration of transient analysis of RC and RL circuits.
02. Built-in +5V DC power supply.
03. Built-in signal generator.

Technical Specifications:

- | | |
|--------------------|----------------------|
| 01 Mains supply | : 230V ±10, 50Hz |
| 02 DC power supply | : +5V |
| 03 Dimensions (mm) | : W340 X H125 X D210 |
| 04 Weight | : 1.1 KG (Approx) |

List of Accessories:

- | | |
|--------------------------------------|----|
| 01 Patch cord 50cm - 4 mm Red..... | 01 |
| 02 Patch cord 50cm - 4 mm Black..... | 01 |

Other Apparatus Required

- 01 Digital Storage Oscilloscope

Transient Analysis of RLC Circuit

Order Code - 36334



Transient Analysis of RLC Circuit, 36334 has been designed specifically for the Transient Response Analysis with AC signal as input. This is useful for students to study and analyze the behavior of any circuit during the transient period. The study of transient and steady state response of a circuit is very

important as they form the building block of most electrical circuits.

With this product, we can easily compare the Under Damped, Critically Damped and Over Damped cases with the theoretical and practical approach

Object:

01. Study the transient response of a series RLC circuit with TTL for under damped, critically damped and over damped cases

Features:

01. Easy experimental illustration of Transient Analysis of RLC circuit
02. Built-in Signal Generator

Technical Specification:

01. Mains Supply : 230 V \pm 10%, 50 Hz
02. Dimensions (mm) : W X H125 X D210
03. Weight : 1.1 Kg (Approx)

List Of Accessories:

01. Patch Cord 4mm length 50cm Red.....02
02. Patch Cord 4mm length 50cm Black.....01

Other Apparatus Required

01. Digital Storage Oscilloscope 01

Two Port Network Trainer

Order Code - 36335



Two Port Network Trainer 36335 has been designed specifically for the Two Port Network analysis. This is useful for students to study the operation and behavior of any two-port network under several operating conditions. The study of two-port network is very important as they form the building block of most electrical systems.

On this training system, we can calculate various parameters under open circuit and short circuit conditions. Experimental calculations of Z-Parameters, Y-Parameters and ABCD-Parameters of a two port network can be easily measured. In built DC power supply is provided.

Object:

01. Study of Z-Parameters of a Passive Two Port Network
02. Study of Y-Parameters of a Passive Two Port Network
03. Study of ABCD-Parameters of a Passive Two Port Network

Technical Specification

01. **Mains Supply** : 230 V \pm 10%, 50Hz
02. **DC Power Supplies** : +12 V, +5 V
03. **Dimensions (mm)** : W340X H125 X D210
04. **Weight** : 1 g (Approx)

Two Port Ladder Trainer

Order Code - 36336



Two Port Ladder Trainer 36336 is a useful trainer to illustrate the importance of Transfer Function of two port ladder network. It is the general configuration of a ladder network in which series arm is represented as Impedance arm and Shunt arm is represented as Admittance arm.

If each arm represents one element, the network is known as a simple ladder network otherwise, the ladder network may contain arms, which represent series - parallel combination of elements. It can be used as stand alone unit with inbuilt DC power supply.

36336 includes the experimental calculation of Transfer Function of 4to 9clrJMernetwoIt1 (and verifies the results by comparing it with the theoretical value in a simple manner. The training system helps one to be fully acquainted with the significance of Transfer Function of two port ladder network.

Object:

01. Study and verification of Transfer Function of Two Port Ladder Network

Features:

01. Exclusive and Compact design
02. Inbuilt +12 V DC Power Supply

Technical Specification

01. **DC Power Supply** : 12 V, 100 mA
02. **Transfer Function (Theoretical)** : 0.205
03. **Transfer Function (Practical)** : 0.205
04. **Weight** : 1.1 Kg. (Approx)
05. **Dimensions (mm)** : W340XH125XD210

T and p Attenuator Trainer

Order Code - 36337



36337 T & p Attenuator trainer has been designed for the study of Attenuators.

Practical experience on this board carries grate educative value for science an Science & Engineering Students.

Object:

01. Study of Symmetrical T Attenuator.
02. Study of Symmetrical p Attenuator.

Features:

The board consists of the following built-in parts :

01. One T and p network.
02. Adequate no. of electronic components.
03. Good Quality, reliable terminal/sockets are provided at appropriate places on panel for connections /observation of waveforms.

04. Strongly supported by detailed Operating Instructions, giving details of Object Theory, Design procedures, Report Suggestions and Book References.
05. Weight : 1.500 Kg. (Approx.)
06. Dimension : W 340 x H 125 x D 210

List of Accessories:

01. Patch cords 4mm length 50cm Red.....02
02. Patch cords 4mm length 50cm Black.....03

Other Apparatus Required

01. Audio frequency Generator
02. Digital multi meter
03. Dual trace CRO

Interconnection of Two Port Network

Order Code - 36338



Interconnection of Two Port Network has been designed specifically to demonstrate the importance of Interconnection of Two Port Networks. It can be used as a stand alone unit with inbuilt DC power supply. With this product, we can calculate various parameters like Z, Y and ABCD under series, parallel and cascade connection of Two port network. It can be performed in a sequential manner and correspondingly it illustrates the phenomenon of loading effect. Various scope of learning makes the subject study complete and interesting.

Object:

01. Study of cascade connection of two port networks
02. Study of series connection of two port network
03. Study of parallel connection of two port network
04. Study of loading effect with cascade connection of two port networks
05. Study of loading effect with series connection of two port network
06. Study of loading effect with parallel connection of two port network

Technical Specification:

- 01 Mains supply : 230V ±10%, 50Hz
- 02 DC power supply : +12V, +5V
- 03 Dimensions (mm) : W340 x H125 x D210
- 04 Weight : 1.1Kg (Approx)

Lis of Accessories:

- 01 Patch Cord 4mm length 50cm Red.....02
- 02 Patch Cord 4mm length 50cm Black.....02

Other Apparatus Required

01. Digital Storage Oscilloscope
02. Digital Multimeter

Post Office Box Trainer

Order Code - 36339



36339 Post Office Box Trainer is the combination of resistance which work on the principle of Wheatstone Bridge. Post Office Box is helpful to determine the unknown resistance of wires like Constantan, and Nichrome etc. With the help of 39339 we can determine the specific resistance of different types of wire. Post Office Box can also verify the combination of resistances in series and parallel.

Object:

01. Determination of unknown resistance.
02. Determination of resistivity of the material of wire.
03. Verification of effects of resistance in series and parallel.

Features:

01. Sample : Constantan, Nichrome
02. Provided with DC power supply
03. Easy to operate

Technical Specification

- Mains : 230 V AC ± 10%, 50 Hz
 Fuse : 100 mA
 DC Power Supply : 5V at 200 mA
 Galvanometer
 Deflection : Using DPM 31/2 digit.

Other Resistance

- Type : Variable
 Range : 0 -10 K Ohms.

List of Accessories

01. Patch cord 4mm length 50cm Red.....02
02. Patch cord 4mm length 50cm Black.....02
03. Patch cord 4mm length 50cm + Crocodile clip Red.....01
04. Patch cord 4mm length 50cm + Crocodile clip Black.....02
05. Wire Constantan Sample 1 meter..... 01
06. Wire Nichrome Sample 1 meter.....01

Kelvin Bridge Trainer

Order Code - 36340



Technical Specification:

- * Kelvin Bridge
- * Potentiometer of 1KW
- * 10KW potentiometer is a helical 10 turn pot mounted with dial for easy measurement
- * Fixed Resistance 10MW, 1MW, 100KW, 10KW, 1KW, 100W & 10W available through Selector Switch
- * Block Description Screen printed on glassy epoxy PCB
- * One LED indicator to indicate Power input.
- * OUTPUT Waveform - Sine
- * All interconnections are made using 2mm banana Patch cords.
- * Bare board Tested Glass Epoxy PCB is used.
- * Test points are provided to analyze signals at various points.
- * Set of 2mm Patch cords for interconnections

Basic Antenna Trainer

Order Code - 10004



Basic Antenna Trainer has been designed to provide useful tools for hands on experimentation and teaching of various commonly used antennas in UHF-Microwave band in the laboratory for students of all levels. It can be used in stand-alone mode. In this system, receiving antenna is rotated manually from 0 to 360 degrees and accordingly the signal strength can be monitored on the Receiver. It comes with a Polar plotting software for storing readings manually
The system consists of a set of two tripods one for mounting the transmitting antenna and another for mounting the receiving antenna, 11Antennas, RFTransmitter/ Receiver, Antenna Plotting Software and relevant accessories/ cables.

Network Analyser: RF Transmitter & Receiver:

Frequency : 86 - 860 MHz PLL synthesized
 Step Size : 0.05, 0.1, 0.25, 0.5, 1, 10, 100 Mhz
 Accuracy : 0.01%
 Display : 16X2 Backlit LCD
 Functions : Menu, Enter, Escape, Up & Down
 Memory Location : 1000 individual frequencies and level can be stored/recalled
 Output Impedance : 50 Ohms
 RF Level : 90 dBuVTypical
 Measurement : RF level in dBuV with 0.1dB resolution
 Dynamic Range : 60 dB Log
 Manual Mode : Data logging for antenna gain polar/cartesian plot
 USB interface : Easy connectivity to PC using polar pattern plotting software
 Power Supply : 230V @ 50 Hz

Experiments:

01. Variation of field strength with distance
02. Plot radiation pattern of omni directional antenna
03. Plot radiation pattern of directional antenna
04. Polarization of vertical and horizontal antenna
05. Study resonant and non resonant antenna
06. Demonstrate reciprocity theorem of antennas
07. Study current distribution along the element of antenna
08. Study different antennas polar plots, radiation patterns, gain, beam width, front back ratio
09. Comparison of different antennas

PC Based Manual Antenna Trainer

Order Code - 10005



PC Based Manual Antenna Trainer has been designed to provide useful tools for hands on experimentation and teaching of various commonly used antennas in VHF-UHF-Microwave band in the laboratory for students of all levels. It can be used in stand-alone mode as well as be interfaced with a computer via USB interface. In this Receiving antenna is rotated manually from 0 to 360 degrees and accordinglyreceiving antennas signal strength can be monitored on the Receiver. The system consists of a set of two tripods one for mounting the transmitting antenna and another for mounting the receiving antenna, 22 Antennas, RF Transmitter/ Receiver, Antenna Plotting Software and relevant accessories/ cables.

Network Analyser: RF Transmitter & Receiver:

Frequency : 86 - 860 MHz PLL synthesized
 Step Size : 0.05, 0.1, 0.25, 0.5, 1, 10, 100 MHz
 Accuracy : 0.01%
 Display : 16X2 Backlit LCD
 Functions : Menu, Enter, Escape, Up & Down
 MemoryLocation : 1000 individual frequencies and level can be stored/recalled
 Output Impedance : 50 Ohms
 RF Level : 90 dBuVTypical
 Measurement : RF level in dBuV with 0.1dB resolution
 Dynamic Range : 60 dB Log
 Manual Mode : Data logging for antenna gain polar/cartesian plot
 USB interface : Easy connectivity to PC using polar pattern plotting software
 Power Supply : 230V @ 50 Hz

Experiments:

01. Variation of field strength with distance
02. Plot radiation pattern of omni directional antenna
03. Plot radiation pattern of directional antenna
04. Polarization of vertical and horizontal antenna
05. Study resonant and non resonant antenna and estimate VSWR and impedance
06. Demonstrate reciprocity theorem of antennas
07. Study current distribution along the element of antenna
08. Study different antennas polar plots, radiation patterns, gain, beam width, front back ratio
09. Comparison of different antennas

PC Based Motorized Antenna Trainer

Order Code - 10006



PC Based Motorized Antenna Trainer has been designed to provide useful tools for hands on experimentation and teaching of various commonly used antennas in VHF-UHF-Microwave band in the laboratory for students of all levels. It can be used in stand-alone mode as well as be interfaced with a computer via USB interface. In this Receiving Antenna can be rotated from 0 to 360 Degrees automatically with the help of

Stepper motor controller unit and accordingly Receiving Antennas Signal strength can be monitored. The system consists of a set of tripod for mounting the transmitting antenna and another stepper motor controlled antenna positioning pod for mounting the receiving antenna, 22Antennas, RF Transmitter, RF Receiver, Stepper Controller Unit, Antenna Plotting Software and relevant accessories/ cables.

Network Analyser: RF Transmitter & Receiver:

- Frequency : 86 - 860 MHz PLL synthesized
- Step Size : 0.05, 0.1, 0.25, 0.5, 1, 10, 100 MHz
- Accuracy : 0.01%
- Display : 16X2 Backlit LCD
- Functions : Menu, Enter, Escape, Up & Down
- Memory Location : 1000 individual frequencies and level can be stored/recalled
- Output Impedance : 50 Ohms
- RF Level : 90 dBuV Typical
- Measurement : RF level in dBuV with 0.1dB resolution
- Dynamic Range : 60 dB Log
- Manual/ Auto Mode : Data logging for antenna gain & polar/cartesian plot
- USB interface : Easy connectivity to PC using polar pattern plotting software
- Power Supply : 230V @ 50 Hz

Stepper Motor Controller Unit:

- Rotation : 0-360 Degrees with 1 Deg resolution
- Angular Steps : 1, 5, 10, 45 degrees
- Display : 16X2 Backlit LCD
- Functions : Menu, Enter, Escape, Up & Down
- Memory : 1000 memories for storing angular positions for quick recall
- Auto mode : Automatic Rotation with Interface to Receiver
- Mode : Clockwise/Anti Clockwise Rotation, Fast/Slow Speed

Experiments:

01. Variation of field strength with distance
02. Plot radiation pattern of omni directional antenna
03. Plot radiation pattern of directional antenna
04. Polarization of vertical and horizontal antenna
05. Study resonant and non resonant antenna and estimate VSWR and impedance
06. Demonstrate reciprocity theorem of antennas
07. Study current distribution along the element of antenna
08. Study different antennas polar plots, radiation patterns, gain, beam width, front back ratio
09. Comparison of different antennas

Shipping List Order Code - 10006 : Antennas

01. Microstrip Rectangular Patch
02. Microstrip Circular patch
03. Microstrip Ring
04. Microstrip Triangular patch
05. Crossed Dipole RHCP
06. Microstrip Slot
07. Microstrip Colinear

08. Microstrip Semicircular patch
09. Log Periodic
10. Dipole L/2
11. Axial Mode Helix RHCP
12. Endfire Array L/2
13. Phase Array L/4
14. Broadside Array L/2
15. Dipole L/4
16. Yagi Uda (4E)
17. Yagi Uda (3E)
18. Folded Dipole
19. Monopole
20. Sleeve
21. Axial Mode Helix LHCP
22. Square Loop

Other Accessories

- A. RF Transmitter Tripod
- b. USB Connecting Lead
- c. Experimental Manual
- d. Antenna Plotting Software CD

Antenna Trainer with 11 Antennas

Order Code - 10008



The desktop Antenna Training System Order Code-10008 has been specially designed for engineering colleges and training centers. It is very useful for introducing practical verification of antenna operation to the students. The work book provides theoretical concepts and detail procedure of experiments with each type of antenna.

The training system includes set of modular mechanical elements forming various antennas, a transmitter unit and a detector unit. All the accessories are packed in a convenient carrying case. The Antenna Training System also comes with Motorised Antenna Unit (Model Order Code-10010) to automate the recording of the radiation pattern of the antennas. The Motorised Antenna Unit consists of a Microcontroller based system for Capturing, Displaying and Printing of Antenna radiation pattern. The system capture signal at an interval of 1° rotation using stepper motor and radiation pattern is displayed on PC . The Windows based Software is supplied in CD Rom. The PC Communication is via RS232 port. It used with Order Code-10010.

Features:

01. Self Contained Simple and Student Friendly platform
02. Hands on set-up for measuring and plotting radiation Patterns of
03. 20 different Antennas
04. On board RF & Tone Generators
05. Antenna Matching Stub
06. Characteristics and SWR Measurement
07. Transmitting and Receiving levels observed On
08. Built-in Meters
09. Functional Block indicated On- board Mimics
10. Fully Documented Operating Manual and Polar Charts

11. "Antenna kit" for fabricating Special Antenna
12. Compact Design
13. Lightweight
14. 2 Year Warranty

Antenna Trainer with 22 Antennas

Order Code - 10009



The desktop Antenna Training System Order Code-10009 has been specially designed for engineering colleges and training centers. It is very useful for introducing practical verification of antenna operation to the students. The work book provides theoretical concepts and detail procedure of experiments with each type of antenna.

The training system includes set of modular mechanical elements forming various antennas, a transmitter unit and a detector unit. All the accessories are packed in a convenient carrying case. The Antenna Training System also comes with Motorised Antenna Unit (Model Order Code-10010) to automate the recording of the radiation pattern of the antennas. The Motorised Antenna Unit consists of a Microcontroller based system for Capturing, Displaying and Printing of Antenna radiation pattern. The system capture signal at an interval of 1° rotation using stepper motor and radiation pattern is displayed on PC . The Windows based Software is supplied in CD Rom. The PC Communication is via RS232 port. It used with Order Code-10010.

Features:

01. Self Contained Simple and Student Friendly platform
02. Hands on set-up for measuring and plotting radiation Patterns of 20 different Antennas
03. On board RF & Tone Generators
04. Antenna Matching Stub
05. Characteristics and SWR Measurement
06. Transmitting and Receiving levels observed On Built- in Meters
07. Functional Block indicated On- board Mimics
08. Fully Documented Operating Manual and Polar Charts
09. "Antenna kit" for fabricating Special Antenna
10. Compact Design
11. Lightweight
12. 2 Year Warranty

Technical Specifications

Waveforms	: Sine
RF Generator	: 750 Mhz approximately (output adjustable)
Tone Generator	: 1 KHz approximately (output adjustable)
Directional Coupler	: Forward & Reverse (selectable)
Matching Stub	: Slider type
Antenna Rotation	: 0-360 deg. Resolution 1 deg.
Receiving Antenna	: Folded dipole with reflector
Detector Display	: Level adjustable meter

Interconnections	: 2 mm Banana sockets
Power Supply	: 230 V, ±10% 50/60 Hz
Power Consumption	: 3 VA approximately
Operating Conditions	: 0-400 C, 80% RH
Weight	: 3 Kg approximately
Dimensions (mm)	: W 385 x D 75 x H 285

Experiments:

01. Polar plots & polarization
02. Wave modulation & demodulation
03. Antenna gain, Antenna beam width study
04. Element current, Front-back ratio study
05. Antenna matching
06. Antenna radiation with distance

Motorised Antenna Trainer with Plotting Software and 22 Antennas

Order Code - 10010



Features:

01. Microcontroller Based High Precision DC Stepper Motor
02. Automatic Zero Point setting
03. Built-in DC Power Supply
04. Instant Plotting of radiation Pattern
05. Resolution 1.8°
06. RS232 data link to PC
07. Software running under Windows 98/XP/Window7
08. 2 Year Warranty

Technical Specifications

RF Input	: From Order Code - 10008
Detector	: Active with 5 pin DIN Connector
Antenna Rotation	: 360° (Resolution 1.8°)
Power Supply	: 230V ± 10%, 50/60 Hz
Power Consumption	: 2 VA (approximately)
Dimensions (mm)	: W 285 × D 390 × H 88
Weight	: 3 Kg (approximately)
Accessories	: Mains Cord, 5 Pin DIN cable, Patch Cords, BNC-BNC Cable, Rs232 Cable, Radiation Pattern Plotting Software

Experiments:

01. Polar plots & polarization
02. Wave modulation & demodulation
03. Antenna gain, Antenna beam width study
04. Element current, Front-back ratio study
05. Antenna matching
06. Antenna radiation with distance

List of Accessories (Full Unit)

I. Antennas	: 22 nos.
01. Simple Dipole l/2	: 1 no.
02. Simple Dipole l/4	: 1 no.
03. Simple Dipole 3l/2	: 1 no.
04. Folded Dipole l/2	: 1 no.
05. Yagi-UDA Folded Dipole (3E)	: 1 no.

- 06. Yagi-UDA Folded Dipole (5E) : 1 no.
- 07. Yagi-UDA Simple Dipole (5E) : 1 no.
- 08. Yagi-UDA Simple Dipole (7E) : 1 no.
- 09. Hertz Antenna : 1 no.
- 10. Zeppelin Antenna : 1 no.
- 11. I/2 Phase Array : 1 no.
- 12. I/4 Phase Array : 1 no.
- 13. Combined Co-linear Array : 1 no.
- 14. Broad Side Array : 1 no.
- 15. Log Periodic Antenna : 1 no.
- 16. Cut Paraboloid Antenna : 1 no.
- 17. Loop Antenna : 1 no.
- 18. Rhombus Antenna : 1 no.
- 19. Ground Plane : 1 no.
- 20. Slot Antenna I/2 : 1 no.
- 21. Helix Antenna : 1 no.
- 22. Detector Antenna : 1 no.

II. Rods for Ground Plane Antenna

- 01. 6.9cm : 1 no.
- 02. 8.5cm : 1 no.
- 03. 20.5cm : 1 no.

III. Current Probe : 1 no.

IV. Transmitting Mast : 1 no.

V. RF Detector : 1 no.

VI. Receiving Mast : 1 no.

VII. Accessories Kit :

- 01. BNC Tee : 1 no.
- 02. BNC - BNC Adapter (M) : 1 no.
- 03. BNC - BNC Adapter (F) : 1 no.
- 04. BNC (M) - BNC (F) Adapter (L-type) : 1 no.
- 05. BNC BNC Cable 25" : 2 nos.
- 06. BNC BNC Cable 18" : 1 no.
- 07. Aligner 932 : 1 no.

VIII. Polar Graphs (dBmA) : 25 nos.

IX. Polar Graphs (For normalised reading) : 25 nos.

X. Antenna Fabrication Kit

- 01. Two PCB's : 1 no.
- 02. 14 SWG wire roll 20" : 1 no.
- XI. Mains Cord : 1 no.**
- XII. VIP Suitcase : 1 no.**
- XIII. +7.5 - 9V DC Adaptor(500mA) : 1 no**

Advanced Antenna Trainer with variable frequency (550 MHz - 850 MHz) and 11 Antennas

Order Code - 10011



Antenna platform Order Code -10011 is a student friendly trainer kit for studying characteristics of different antennas. Order Code -10011 is designed so that students can take the readings and plot the polar plots themselves, thus understanding the subject thoroughly. They can even stop & repeat the readings in between if needed.

All the antennas are made by high conducting rods with chrome finish for long durability and mounted on the glass epoxy PCB for easy mounting and dismantling Areas of Experimentation and Study

- * Polar plot & Polarization of various antennas.
- * Wave modulation and Demodulation
- * Antenna Gain
- * Antenna Beam Width.
- * Element Current study.
- * Front Back Ratio study.
- * Antenna matching.
- * SWR measurement.
- * Antenna radiation with distance.
- * Antenna bandwidth measurement

Features:

- 01. Self contained, simple and student friendly trainer
- 02. Hands on set-up for measuring and plotting radiation patterns of different Antennas
- 03. Built in RF & Modulation generators
- 04. Built in frequency display
- 05. Antenna Matching Stub
- 06. Characteristics and SWR measurement
- 07. Transmitting and Receiving levels observed on meters
- 08. Built in DC power supply
- 09. Fully documented, Operating manual and polar charts (2 types) with each trainer
- 10. "Antenna kit" for fabricating special antenna
- 11. Compact design
- 12. Light weight
- 13. 2 Year Warranty

Technical Specifications:

- RF generator : 550 to 850 MHz approximately (with level adjust)
- Modulation Generator : 1 KHz approximately (300 mV)
- Directional Coupler : Forward & Reverse (On board selectable)
- Matching Stub : Slide Stub
- Antenna Rotation : 0- 360 Degree, Resolution 1 Degree Transmitting & Receiver masts provided
- Receiving antenna : Folded Dipole with reflector
- Detector Display : Adjustable meter
- Interconnections : BNC
- Power Supply : 230 V ±10%, 50/60 Hz
- Power Consumption : 3VA (approximately)
- Weight : 3 kgs. Approximately
- Dimensions : W 285 × H 75 × D 385

Experiment:

- 01. Study of Simple Dipole I/2 Antenna
- 02. Performing Polarisation Test and Modulation Test
- 03. Study of Reciprocity Theorem
- 04. Study of variations in the radiation strength at a given distance from the antenna
- 05. Antenna Current Sensor and SWR Measurement
- 06. Study of Rhombus Antenna, Ground Plane Antenna, Slot
- 07. Antenna, Helix Antenna and antenna bandwidth

Advanced Antenna Trainer with variable frequency (550 MHz - 850 MHz) and 22 Antennas

Order Code - 10012



Antenna platform Order Code-10012 is a student friendly trainer kit for studying characteristics of different antennas. Order Code-10012 is designed so that students can take the readings and plot the polar plots themselves, thus understanding the subject thoroughly. They can even stop & repeat the readings in between if needed.

All the antennas are made by high conducting rods with chrome finish for long durability and mounted on the glass epoxy PCB for easy mounting and dismounting Areas of Experimentation and Study

- * Polar plot & Polarization of various antennas.
- * Wave modulation and Demodulation
- * Antenna Gain
- * Antenna Beam Width.
- * Element Current study.
- * Front Back Ratio study.
- * Antenna matching.
- * SWR measurement.
- * Antenna radiation with distance.
- * Antenna bandwidth measurement

Features:

01. Self contained, simple and student friendly trainer
02. Hands on set-up for measuring and plotting radiation patterns of different Antennas
03. Built in RF & Modulation generators
04. Built in frequency display
05. Antenna Matching Stub
06. Characteristics and SWR measurement
07. Transmitting and Receiving levels observed on meters
08. Built in DC power supply
09. Fully documented, Operating manual and polar charts (2 types) with each trainer
10. "Antenna kit" for fabricating special antenna
11. Compact design
12. Light weight
13. 2 Year Warranty

Technical Specifications:

RF generator	: 550 to 850 MHz approximately (with level adjust)
Modulation Generator	: 1 KHz approximately (300 mV)
Directional Coupler	: Forward & Reverse (On board selectable)
Matching Stub	: Slide Stub
Antenna Rotation	: 0-360 Degree, Resolution 1 Degree Transmitting & Receiver masts provided
Receiving antenna	: Folded Dipole with reflector
Detector Display	: Adjustable meter
Interconnections	: BNC
Power Supply	: 230 V ±10%, 50/60 Hz
Power Consumption	: 3VA (approximately)
Weight	: 3 kgs. Approximately
Dimensions	: W 285 × H 75 × D 385

Experiments:

01. Study of Simple Dipole I/2 Antenna
02. Performing Polarisation Test and Modulation Test
03. Study of Reciprocity Theorem
04. Study of variations in the radiation strength at a given distance from the antenna
05. Antenna Current Sensor and SWR Measurement

06. Study of Rhombus Antenna, Ground Plane Antenna, Slot
07. Antenna, Helix Antenna and antenna bandwidth

Personal Computer Aided Antenna Design Software

Order Code - 10014



PCAAD 5.0 is the newest version of the most popular general purpose antenna modeling software. PCAAD 5.0 is a Windows-compatible antenna analysis, modeling, and design software package. It contains more than 40 separate routines treating wire antennas, aperture antennas, microstrip antennas, arrays, and transmission lines and waveguides. These routines are integrated into a menu-driven, user-friendly system allowing you to quickly evaluate impedance and patterns for a wide variety of antenna types. Some of the new features in Version 5.0 include the following:

Features:

01. 3-D color pattern plots
02. Impedance matching with Smith chart
03. Analysis of circular planar arrays
04. V-dipole antenna analysis
05. Wire loop antenna analysis
06. Log periodic dipole array analysis
07. More general wire antenna geometries
08. Ability to copy graphs to Windows clipboard
09. Improved error checking
10. Movable labels on pattern and Smith plots
11. Improved plot resizing
12. Color settings can be saved
13. All wire geometries can be viewed in 3-D
14. Plotting of E/H or E-theta/E-phi patterns
15. Improvements to user interface
06. Antenna Short Course included on CD

PCAAD's antenna analysis and design capabilities are listed below . . .

Array Antennas

- * Uniform linear array patterns
- * Linear subarray patterns
- * Uniform rectangular array patterns
- * Uniform circular array Patterns
- * Arbitrary planar array patterns
- * Infinite printed dipole array
- * Grating lobe diagram
- * Linear array pattern synthesis

Wire Antennas

- * Dipole antenna analysis .
- * RCS of wire dipole
- * V-dipole antenna analysis analysis
- * Loop antenna analysis analysis
- * Yagi array analysis
- * Finite dipole array analysis
- * Log-periodic dipole array analysis

Microstrip Antennas

- * Rectangular probe-fed patch
- * Rectangular line-fed patch analysis

- * Rectangular proximity-fed patch
- * Rectangular aperture coupled patch
- * Circular probe-fed patch analysis
- * General wire antenna analysis

Aperture Antennas

- * Line source patterns
- * E-plane sectoral horn patterns
- * H-plane sectoral horn patterns
- * Pyramidal horn patterns
- * Corrugated pyramidal horn patterns
- * Conical horn patterns
- * Corrugated conical horn patterns
- * Parabolic reflector (approximate)
- * Parabolic reflector (patterns)

Antenna Trainer

Order Code - 10020



10020, Table-top training system. It is very useful to study & understand the principle & working of various antennas and to polar plots by teachers and students. The antennas are designed for use at higher frequencies making them handy and smaller in size for ease of use and better understanding of the subject . RF generator, Tone generator Directional coupler , Matching stub, Forward/Reverse meter, Goniometer & various antennas are provided for experimentation. Necessary DC regulated power supplies are built-in. Functional blocks are indicated on the mimic panel. The trainer includes set of modular mechanical elements forming various antennas, a transmitter unit & a detector unit.

Specifications:

RF Generator

- * Provides RF generated output of approx.750MHZ
- * Provision for output adjustments provided.

Tone Generator

- * Provides Tone generated output of approx.1KHz
- * Provision for output adjustments provided.
- Direction Coupler
- * Forward And Reverse Direction Coupler
- * Provision for selection provided.

Antenna

- * Antenna rotation of 0-360°
- * Antenna Resolution is of 1°
- * Receiving Antenna is Folded dipole type with reflector and Digital meter
- * Twenty One different types of Antennas are : "
 - Dipole /2.
 - Dipole /4.
 - Folded Dipole /2.
 - Yagi UDA Folded Dipole (3E).
 - Yagi UDA Folded Dipole (5 E).
 - Yagi UDA Simple Dipole (5 E).
 - Yagi UDA Dipole (7 E).
 - Horizontal End Fed Hertz Antenna
 - Horizontal End Fed Zeppelin Antenna
 - Ground Plane Antenna.
 - Ground Plane with Reflector & Director Ant.
 - /2 Slot Antenna.

- Loop Antenna.
- Helix Antenna.
- /2 Phase Array Antenna.
- /4 Phase Array Antenna.
- Combined Collinear Array Antenna.
- Log Periodic Antenna.
- Rhombus Antenna.
- Cut Paraboloid Reflector Antenna.
- Circular Loop antenna.

Features:

01. Slider Type Matching Stub provided
02. Digital meter is provided for Forward & Reverse Indication.
03. Goniometer is provided on main panel

Interconnections

- * Interconnections are made using 2mm banana Patch cords.
- * BNC Tee, BNC - BNC adapter and BNC - BNC Cable are provided
- * Power Supply of 230V + 10% VAC, 50 Hertz, Single phase
- * Set of 2mm Patch cords for interconnections
- * Polar Graph Paper provided
- * Current Probe, Mounting stands are provided.
- * User's Manual with experiments

Antenna Trainer (Motorised)

Order Code - 10020M



10020M, table-top training system. It is very useful to study & understand the principle & working of various antennas and to polar plots by teachers and students. The antennas are designed for use at higher frequencies making them handy and smaller in size for ease of use and better understanding of the subject. RF generator, Tone generator Directional coupler, Matching stub, Forward/Reverse meter, Goniometer & various antennas are provided for experimentation. Necessary DC regulated power supplies are built-in. Functional blocks are indicated on the mimic panel. The trainer includes set of modular mechanical elements forming various antennas, a transmitter unit & a detector unit.

Features:

01. Slider Type Matching Stub provided
02. Digital meter is provided for Forward & Reverse Indication.
03. Microcontroller based stepper motor to rotate Antenna in steps
04. Windows based software.
05. RS232 interfaces to communicate with PC.
06. Goniometer is provided on main panel

Interconnections

- * Interconnections are made using 2mm banana Patch cords.
- * BNC Tee, BNC - BNC adapter and BNC - BNC Cable are provided
- * Power Supply of 230V + 10% VAC, 50 Hertz, Single phase

- * Set of 2mm Patch cords for interconnections
- * Polar Graph Paper provided
- * Current Probe, Mounting stands are provided.
- * User's Manual with experiments

Specifications:

- * RF Generator
 - Provides RF generated output of approx.750 MHZ
 - Provision for output adjustments provided.
- * Tone Generator
 - Provides Tone generated output of approx.1 KHz
 - Provision for output adjustments provided.
- * Direction Coupler
 - Forward And Reverse Direction Coupler
 - Provision for selection provided.
- * Antenna
 - Antenna rotation of 0-360° (Motorised)
 - Antenna Resolution is of 1°
 - Receiving Antenna is Folded dipole type with reflector and Digital meter
 - Twenty One different types of Antennas are:
 - ° Dipole l/2.
 - ° Dipole l/4.
 - ° Folded Dipole l/2.
 - ° Yagi UDA Folded Dipole (3E).
 - ° Yagi UDA Folded Dipole (5 E).
 - ° Yagi UDA Simple Dipole (5 E).
 - ° Yagi UDA Dipole (7 E).
 - ° Horizontal End Fed Hertz Antenna
 - ° Horizontal End Fed Zeppelin Antenna
 - ° Ground Plane Antenna.
 - ° Ground Plane with Reflector & Director Ant.
 - ° l/2 Slot Antenna.
 - ° Loop Antenna.
 - ° Helix Antenna.
 - ° l/2 Phase Array Antenna.
 - ° l/4 Phase Array Antenna.
 - ° Combined Collinear Array Antenna.
 - ° Log Periodic Antenna.
 - ° Rhombus Antenna.
 - ° Cut Paraboloid Reflector Antenna.
 - ° Circular Loop antenna.

Satellite Trainer

Order Code - 10201



Features:

01. Emulation of path loss at uplink and downlink
02. Emulation of frequency translation
03. High RF output power and low noise
04. PLL synthesizer in Transmitter, Receiver and Satellite
05. Condenser microphone and speaker for audio link
06. Camera and Monitor for video link
07. 4 Dish for linear polarization study
08. C/N and S/N measurement facility
09. Transmit Audio, Video, Digital/Analog data, Tone, Voice, function generator waveforms etc.
10. Receives & demodulates 3 Signals Simultaneously

Technical Specifications:

Satellite Uplinking Transmitter

- Frequency : 4 channels in 5.8 Ghz band; PLL with frequency selection switch & LED indication
- RF output level : +3 dBm nominal with wideband RF amplifier with no manual matching required
- Audio 1 : Int. 1KHz sine wave / Ext Mic Ext. Function Generator waveform
- Audio 2 : Int. 1KHz sine wave / Ext Mic Ext. Function Generator waveform
- Video : Analog Camera/VCD compatible
- Waveform : upto 5MHz Function Generator
- Digital : Max rate 100KHz typical
- Baseband : Transmits 3 signals simultaneously at each uplink frequency
- Processor : PIC16F4 - 8 bit RISC processor based PLL with 4 Mhz clock
- Bandwidth : 16 Mhz
- Modulation : 5/ 5.5MHz Audio FM Modulation 8 Mhz Video FM Modulation
- Antenna : Detachable Parabolic dish with mount
- Inputs : separate terminals for different inputs
- Power Supply : 100-240VAC 47-63Hz

Satellite Downlink Receiver

- Frequency : 4 channels in 5.8 Ghz band PLL Controlled ISM Band
- Sensitivity : -80dBm
- Audio 1 out : Speaker inbuilt/output
- Audio 2 out : Speaker inbuilt/output
- Video Out : 5MHz, 1V p/p
- Digital : Max rate 100KHz typical TTL
- RSSI Out : Received signal strength output for C/N measurement
- Antenna : Detachable Parabolic dish with mount
- Demodulation : Receives & demodulates 3 signals simulataneously
- Power Supply : 100-240VAC 47-63Hz

Satellite Link Emulator

Transponder Uplink

- Frequency : 4 channels in 5.8 GHz band ; PLL Synthesized ISM Band with select switch
- Sensitivity : -80dBm

Transponder Downlink

- Frequency : 4 channels in 5.8 Ghz band; PLL Synthesized ISM Band
- RF output level : 0 dBm nominal
- Path Loss : Variable attenuation
- Band limiting : 16MHz fixed typical
- Antennas : Detachable Parabolic Dish
- Power Supply : 100-240VAC 47-63Hz

Area and Scope of Experimentation:

- * To set up a passive satellite communication link and study their difference. To study the communication satellite link design: process of transmitting a signal to a satellite (UPLINKING), reception of same signal via satellite (DOWN LINKING) and functioning of transponder of a satellite
- * To measure the baseband analog signal

- parameters in a satellite link
- * To measure the signal parameters in an analog FM/FDM TV Satellite link
- * To study the functionality of a satellite MODEM
- * To study the phenomenon of Linear polarization
- * To measure the C/N ratio
- * To measure the S/N ratio
- * To study the effect of fading and measure the fading margin of a received signal
- * To measure the digital baseband signal parameters in a satcom link

Satellite Communication Lab

Order Code - 10202



Features:

01. Microwave 5.8 & 2.4 GHz operation Satellite Trainer
02. Tele-command and telemetry facility
03. Different Baud rates PC-PC link.
04. Emulation of variable signal fading, variable thermal noise
05. Variable propagation delay.
06. Variable path loss at uplink and downlink channels
07. High RF output power and low noise
08. LCD display of PLL synthesized frequency in

Transmitter, Receiver and Satellite Emulator

09. Microphone and speaker for audio link
10. Camera and Monitor for video link
11. Various antennas Helix (LHCP & RHCP), Dish - 2Nos., Patch- 2 Nos. for linear & circular polarization study
12. Signal monitoring outputs at uplink & downlink
13. C/N and S/N measurement facility

Satellite Uplinking Transmitter

- Frequency : Frequency : 4 channels in 5.8 Ghz band PLL Synthesized ISM Band
- Display : LCD 16X2 Backlit
- Spurious output : -30 dB typical
- RF output level : 0 dBm nominal
- Audio 1 : Int. 1KHz sine wave / Mic/ Ext. Function Generator waveform
- Audio 2 : Int. 1KHz sine wave / Mic/ Ext. Function Generator waveform
- Video : Colour Camera
- Waveform : upto 5MHz Function Generator
- Digital : Max bit rate 500KHz typical
- USB : PC serial port compatible input
- Tele-command : Selectable 4 bit binary input with selectable 4 addresses
- Enable : Telecommand Frame available at digital input

Satellite Downlink Receiver

- Frequency : 2.4, 2.427, 2.454 & 2.481 GHz PLL Synthesized ISM Band
- Display : LCD 16 X 2 Backlit
- Sensitivity : -85dBm
- Audio 1out : Speaker inbuilt/output
- Audio 2 out : Speaker inbuilt/output

- Video Out : 5MHz bandwidth, 1V p/p
- Digital : Max bit rate 500KHz typical TTL
- USB : PC serial port compatible output
- Down-converter : 400-500MHz output for spectrum analysis
- Telemetry : 4 bit binary LED output with Selectable 4 addresses
- Valid/Error : Tele-command Frame available at Correction digital output
- RSSI Out : Received signal strength output for C/N Measurement

Satellite Link Emulator Transponder Uplink

- Frequency : 4 channels in 5.8 Ghz band PLL Synthesized ISM Band
- Display : 16X2 LCD Backlit
- Sensitivity : -85dBm
- Telemetry : 4 bit binary LED output with Selectable 4 addresses
- Valid/Error : Telemetry Frame available at digital Correction output

Transponder Downlink

- Frequency : 2.4, 2.427, 2.454 & 2.481 GHz PLL Synthesized ISM Band
- Display : 16X2 LCD Backlit
- Spurious output : - 30 dB typical
- RF output level : 0 dBm nominal
- Path Loss : Upto 20dB variable attenuation
- Tele-command : Selectable 4 bit binary input with selectable 4 addresses
- Enable : Telecommand Frame available at digital input
- Test Output : Audio 1, Audio2, Video, Digital
- Down-converter : To spectrum analyzer 400-500 MHz
- RSSI Out : Received signal strength output for C/N measurement
- Band limiting : 18MHz fixed typical
- Noise addition : Variable
- Signal delay : upto 0.6s on Audio1 channel
- Signal fading : Variable 10dB
- Antennas : Helix LHCP & Helix RHCP, Microstrip patch, Parabolic Dish - 2 Nos.
- Mount : Antenna mount - 2 Nos.
- Software : PC Serial communication software

Area & Scope of Experiments:

- * To set up a satellite communication link and study their difference. To study the advantages of satellite communication.
- * To study the communication satellite link design: process of transmitting a signal to a satellite (UPLINKING), reception of same signal via satellite (DOWN LINKING) and functioning of transponder.
- * To measure baseband analog signal parameters.
- * To measure the signal parameters like fm deviation in an analog FM/FDM TV Satellite link on.
- * To study the functionality of a satellite MODEM.
- * To measure Linear and Circular polarization of antennas.
- * To measure the C/N ratio, threshold.
- * To measure the S/N ratio.
- * To study the effect of fading and measure the fading margin of a received signal.
- * To measure the Propagation Delay of signal.
- * To measure pathloss.

- * To study noise.
- * To measure the digital baseband signal parameters in a satcom link.
- * To measure the range of baud rates that the system can support.
- * To send telecommand and receive the telemetry Data and study the operation of a codec.
- * To setup a USB satellite communication link using com ports of PC.
- * To calculate Bit Error Rate in a satcom link.

Satellite Communication Trainer

Order Code - 10203



Satellite Communication platform provides an in-depth study of basic Satellite communication system. It consists of Uplink Transmitter, Satellite Link and Downlink Receiver, which can be conveniently placed in the laboratory. The Satellite can be placed at an elevated position if needed. The Satellite Transponder receives signal from Uplink Transmitter and retransmit at different frequencies to a Downlink Receiver. The Uplink and Downlink frequencies are selectable and can have variety of signals such as Video, Audio, Voice, Tone, Data and Telemetry (Temperature and Light intensity). The operating manual illustrates basic theory and glossary of Satellite Communication terms along with Experiments.

Features:

01. Transmitter with selectable frequency conversion
02. Simultaneous communication of three different signals
03. Communicate Audio, Video, Digital data, PC data,
04. Tone, Voice, function generator waveforms etc.
05. 2414 - 2468MHz PLL microwave operation,
06. Communication of external broad band digital signal.
07. Choice of different transmitting and receiving frequencies.
08. Built-in Speaker and Microphone for Voice and Audio link.
09. Remote detection of Light intensity and environment temperature.
10. Detachable Dish Antenna at each station.
11. USB port for PC communication.
12. 2 Year Warranty.

Experiments:

01. Transmitting & receiving three separate Signals (Audio, Video, and Tone/ Voice) simultaneously through satellite link and perform Link Fail Operations.
02. Transmitting & receiving Function Generator Waveforms through Satellite Link.
03. Transmitting and receiving PC data through satellite link.
04. Study the delay between Uplink transmitter and Downlink receiver during data transmission.
05. Send Tele-command and receive Temperature & intensity of light from satellite.
06. Calculate the carrier to noise ratio for a satellite link.

07. Calculate signal to noise ratio for a satellite link.

Technical Specifications:

Uplink Transmitter

- * Transmitter with selectable frequency conversion
- * 2450-2468 MHz up-linking selectable frequencies
- * Wide band RF amplifier. No manual matching required.
- * 16 MHz Bandwidth
- * Frequency select switch and LED indication.
- * FM Modulation of Audio and Video.
- * Coverage area 35m Indoor and 100m outdoor
- * Transmit Audio, Video, Digital data, PC data, Tone, Voice, function generator waveforms etc.
- * Separate section for telemetry operation.

Inbuilt Tone Generator:

- * Frequency: 100Hz to 1 KHz.
- * Amplitude: 0V to 1Vpp.
- * Separate terminals provided for different inputs.
- * Power Supply: 230 VAC \pm 10 %, 50/60 Hz

Satellite Link:

- * Transponder with selectable Uplink and downlinks frequency conversion.
- * Light and Temperature sensors for telemetry operations.
- * Delay knob provided for simulated Transition delay experiment.
- * Optional Solar power supply for Transponder Unit.
- * Detachable Dish Antennas.
- * Power Supply: 230 VAC \pm 10 %, 50/60 Hz

Downlink Receiver:

- * Receiver with selectable frequency conversion.
- * Receives and demodulate three signals simultaneously.
- * Built in speaker for audio and video output.
- * Detachable Dish Antenna.
- * Power Supply: 230 VAC \pm 10 %, 50/60 Hz

Included Accessories:

01. Audio-Video Cable 2 Pin 2 nos.
02. Patch Cord 16"(4mm) 2 nos.
03. Microphone 1 no.
04. Dish Antenna 4 nos.
05. USB Cable 2 nos.
06. Pencil Cell (Microphone) 1 no.
07. Mains Cord 3 nos.
08. PC Software 1 no.

Radar Trainer

Order Code - 10204



The Radar Trainer is a very useful and realistic classroom training equipment. provided with different types of accessories for experimentation and a Windows® based software for observation and calculation of different parameters. On-board Test points are provided which enable students to observe the signals on an Oscilloscope or a PC. The trainer is capable to measure the Speed of object, Frequency of

vibrations and RPM of any fan. Students can also study the properties of different types of material like Metal, Acrylic, Teflon, Bakelite, etc.

Features :

01. Complete hardware and software setup to demonstrate Radar concepts
02. Signals study on Software / Oscilloscope with the help of test help of test points given on trainer
03. Object counter provided on trainer
04. Real time fan RPM measurements and vibrations measurements with the help of tuning forks
05. Tripod stand provided for height and level matching
06. LED Indication for Doppler Echo Signal
07. On board alarm for detected signals

Technical Specifications:

Transmitter Frequency	: 10 GHz
Output Power	: 10 mW (approximate)
Operating Voltage	: 8.6 V
Antenna	: Horn
Antenna Gain	: 16dB
Sensitivity	: -50 to -70dBm
IF Output	: Audio range
Power Supply	: 230 V±10%, 50 Hz
Alarm	: Onboard detected signal indication

About Software

Oscilloscope	: Real time/Storage mode with FFT analysis
Display	: Voltage : Vpp
Speed	: Km/hr, Miles/hr, m/s, rpm
Frequency	: Hz & kHz
Time domain window	: Display the Doppler Frequency in Time domain
Frequency domain window	: Display the Doppler Frequency in Frequency domain
Control Panel window	:
User interface for	: Measurement of Doppler Frequency, Amplitude Measurement of Velocity, RPM

Utilities :

- * Start / Stop of Display
- * Setting of Time base and Amplitude range on display window
- * Printing of Doppler Frequency signal
- * Cursors for Time & Voltage measurements
- * Save, Load

Experiments:

01. Study of the working of a Doppler Radar
02. Study of determine the Velocity of the object moving in the Radar range
03. Study of understand the principle of Doppler Radar of Time and Frequency measurement with the help of moving pendulum
04. Study of an Alarm System by using Radar
05. Study the Object Counting with the help of Radar
06. Study of the detection of vibration of different Tuning forks
07. Determine the rotation per minute (RPM) of a moving object (Fan)
08. Study of the effect of different types of materials

on Radar reception or detection

Included Accessories:

01. Trainer Board
02. Audio Cable for PC Line In input
03. Din connector cable (5 Pin)
04. Mains Cord
05. Tripod Stand
06. Fan Stand
07. Fan
08. Sliding Platform
09. Different objects
10. Horn Antenna
11. Trans-receiver Unit
12. Software CD
13. Pendulum
14. Stand for moving the pendulum
15. Tuning forks
16. Operation manual

Doppler Radar Training System

Order Code - 10205



Features:

01. Demonstrates the principle of Doppler shift of reflected electro magnetic wave from a moving object
02. Speed, rotation, level control, contact less vibration measurement
03. Observation and measurements with software
04. Microwave operation
05. High gain Parabolic antenna provided for narrow beamwidth and clutter reduction.
06. PC based oscilloscope provided
07. FFT with cursor measurement

Technical Specifications:

Microwave Transceiver:

Type	: MMIC transceiver with parabolic dish antenna
Antenna Size	: 25cm dia with f/d 0.25
Frequency	: Microwave DRO stabilized
Output Level	: 0 dBm typical
Sensitivity	: -70dBm typical
Output	: PC Compatible
Power Supply	: 100-240V, 47-63 Hz

Software:

Display	: Responsive real-time up to 50 fps refresh
Bandwidth	: 10 Hz - 20 kHz, AC coupling
Timebase	: 10 us - 5 s
ADC	: 8-bit and 16-bit acquisition
Sampling	: 11 kHz to 44 kHz rate
FFT	: Amplitude and/or phase System
PC required	: Windows® 7 or 8 sound card,(Not supplied)
Data export	: Raw data export as WAV file
Screenshot	: Saved in BMP and EMF formats
Visible trace	: can be saved as text file
Function	: Copy-paste for screenshots or data

- files - Printing,
 Triggering : Adjustable trigger level, slope, and delay
 Pretrigger : View - Single shot triggering mode
 Measure : On screen - Two cursors set by left and right click - Voltage and time difference readout - Direct frequency readout

Radar Jammer cum Moving Target Emulator:

Range : 0 to 1000km/hr

List of experiments:

- * To investigate the fundamental concepts of Doppler radar
- * To setup radar and tune it for best performance
- * To measure speed of a fan
- * To detect the presence of a hidden Time Bomb with the help of a Doppler radar
- * To find out the Time period and frequency of a moving Pendulum for different lengths
- * To actuate the opening of a door, Traffic signal, Intrusion alarm etc. with the help of a radar
- * To measure the units of items being produced in an assembly line production unit
- * To determine the presence of moving plasma from one electrode to other in a Tube light
- * To detect the presence of transformer hum and find its frequency
- * To measure the variable speeds of moving objects using Velocity simulator
- * Calibration of Doppler radar using tuning fork
- * To study the reflective, absorptive and transmissive properties of materials using radar and velocity simulator
- * To find the speed of a moving object with Doppler radar from different angles
- * To find the speed of a moving object approaching or receding away from radar from different-different angles
- * To estimate the size of a moving objects using Radar
- * To find out the presence of a Pedestrian and manage Traffic till he walks away
- * To find out the presence of an aero plane with the rotation of the turbine of its engine as used by Air Force
- * To study the use of radar in detecting respiration and heart beating
- * Study of climatic conditions of atmosphere cyclones, Clouds, tornado using a Doppler radar

Accessories:

- * Tuning Fork, Buzzer, Turbine Fan, Pendulum

RF Training System

Order Code - 10206



Technical Specifications:
RF Tuned Amplifier Module

Center freq. : 100-150 MHz typ. varactor tuned

RF Oscillators:

- a. **RFT-02-A Colpitts RF Oscillator Module:**
 Frequency : >100 MHz typical
- b. **RFT-02-B Hartley RF Oscillator Module:**
 Frequency : >100 MHz varactor tunable
- c. **RFT-02-C Clapp RF Oscillator Module:**
 Frequency : >100 MHz varactor tunable
- d. **RFT-02-D Pierce RF Oscillator Module:**
 Frequency : 48.25 Mhz

RF Crystal Oscillators:

- a. **RFT-03-A Feedback Crystal Oscillator Mod.:**
 Frequency : 10 MHz typical
- b. **RFT-03-B Colpitts Crystal Oscillator module:**
 Frequency : 38.9 MHz typical
- c. **RFT-03-C Butler Crystal oscillator module:**
 Frequency : above 80 MHz
- d. **RFT-03-D Crystal frequency multiplier mod.:**
 2nd harmonic : >10dB fundamental

IF Amplifiers:

- a. **RFT-04-A FM IF amplifier module:**
 Center freq. : 10.7 MHz
- b. **RFT-04-B TVVI F amplifier module:**
 Center freq. : 36.15 MHz
- c. **RFT-04-C Satellite IF amplifier module:**
 Center freq. : 479.5MHz typical

RF Mixers:

- a. **RFT-05-A Single ended Diode Mixer:**
 LO /RF freq. : 500-1000 MHz typical
- b. **RFT-05-B Single Balanced Diode mixer:**
 LO/RF freq. : 25-500 MHz typical
- c. **RFT-05-C Double balanced diode mixer:**
 RF / LO freq. : 500-1000 MHz typical
- d. **RFT-05-D Transistor Mixer Module:**
 LO input typical : 400-600 MHz
 Conversion gain : +3dB

RF Filters:

- a. **RFT-06-A1 High Pass Filter Module:**
 Filter type : Butterworth 7th order
 Cut off freq. : 350 MHz typical
- b. **RFT-06-A2 High Pass Filter Module:**
 Filter type : Chebyshev 7th order
 Cut off freq. : 350 MHz typical
- c. **RFT-06-B1 Low Pass Filter Module:**
 Filter type : Butterworth 7th order
 Cut off freq. : 350 MHz typical
- d. **RFT-06-B2 Low Pass Filter Module:**
 Filter type : Chebyshev 7th order
 Cut off freq. : 350 MHz typical
- e. **RFT-06-C1 Band Pass Filter Module:**
 Filter type : Butterworth 5th order
 F1 & F2 : 100 & 350 MHz typical
- f. **RFT-06-C2 Band Pass Filter Module:**
 Filter type : Chebyshev 5th order
 F1 & F2 : 100 & 350 MHz typical
- g. **RFT-06-D Notch Filter Module:**
 Center freq. : 350 MHz nominal

E-Manual: Installation Video for ease of Learning

List of experiments:

01. To measure the center frequency of RF tuned amplifier.
02. To measure the gain of RF tuned amplifier module.
03. To measure the bandwidth of RF tuned amplifier.
04. To measure the variation of center frequency with tuning
05. To measure the 1dB compression of RF amp.
06. To measure the frequency of RF oscillator.

07. To measure the output power level of RF oscillator.
08. To measure the frequency and level of various harmonics
09. To observe the effect of capacitive feedback ratio
10. To observe the effect of voltage on frequency, level, harmonics
11. To measure the frequency of RF crystal oscillator.
12. To measure the level of RF crystal oscillator.
13. To measure the harmonics of RF crystal oscillator
14. To measure the frequency pulling characteristic of RF crystal osc
15. To measure the phase noise of RF oscillator.
16. To measure the center frequency of IF amplifier.
17. To measure the gain of IF amplifier modules.
18. To measure the bandwidth of IF amplifier modules.
19. To measure the 1dB compression of IF amplifier
20. To measure conversion gain/loss for mixer.
21. To measure the 1dB compression level for mixer.
22. To measure the LO/RF, LO/IF isolation for mixer.
23. To measure the optimum LO drive level for minimum distortion/conversion loss for mixer.
24. To measure the dynamic range for mixer modules.
25. To measure VSWR of mixer RF /LO /IF ports.
26. To measure the LO/RF frequency range of mixer.
27. To measure the IF frequency range of mixer.
28. To measure the insertion loss of RF filter.
29. To measure the pass band and stop band frequency
30. To measure the cut off frequency of RF filters.

RF Training Lab

Order Code - 10208



RF Training Lab is designed to allow you to actually SEE the Electronic Spectrum in "real time". The modulation products and sidebands of AM, FM, SSB, DSB, DSB-SC, VSB waveforms can be studied. The frequency range and high sensitivity is suited to EMI/EMC measurements, both radiated and conducted. A tracking signal source along with directional coupler can be used to measure any two port network. Different training modules are provided for study and experimentation.

Features:

01. 50MHz to 500MHz measurement range
02. Waveform and modulation independent
03. Low cost with high performance
04. Inbuilt frequency counter
05. Wide input range -85dBm to 20Vp-p
06. RF modules for experimentation
07. Tracking signal source for network analysis

Technical Specifications:

Frequency	: 50 MHz – 500 MHz
Center frequency	: 4 digit LED display .
Resolution	: 100KHz
Input Impedance	: 50 Ohms (BNC)
Horizontal scan upto	: 50MHz/div continuous
Center freq.	: Variable control
CRO Output	: Linear X out (BNC) Log Y out (BNC)
Tracking signal	: 60dBuV

Impedance	: 50 Ohms
Power Supply	: 100-240V AC; 47-63 Hz
Accessories	: Mains Lead, BNC-BNC

Directional coupler 10-500 Mhz:

RF Training Lab

The RF lab consists of different modules of RF Oscillators, IF amplifiers, RF Mixers and RF Filters etc with following Specifications:

01. RFT-01 RF Tuned Amplifier Module:
02. RF Oscillators:
 - a. RFT-02-A Colpitts RF Oscillator Module:
 - b. RFT-02-B Hartley RF Oscillator Module:
 - c. RFT-02-C Clapp RF Oscillator Module:
 - d. RFT-02-D Pierce RF Oscillator Module:
03. RF Crystal Oscillators:
 - a. RFT-03-A Feedback Crystal Oscillator :
 - b. RFT-03-B Colpitts Crystal Oscillator :
 - c. RFT-03-C Butler Crystal oscillator module:
 - d. RFT-03-D Crystal frequency multiplier:
04. IF Amplifiers:
 - a. RFT-04-A FM IF amplifier module:
 - b. RFT-04-B TV VIF amplifier module:
 - c. RFT-04-C Satellite IF amplifier module:
05. RF Mixers:
 - a. RFT-05-A Single ended Diode Mixer:
 - b. RFT-05-B Single Balanced Diode mixer:
 - c. RFT-05-C Double balanced diode mixer:
 - d. RFT-05-D Transistor Mixer Module:
06. RF Filters:
 - a. RFT-06-A1 High Pass Filter Butterworth
 - b. RFT-06-A2 High Pass Filter Chebyshev
 - c. RFT-06-B1 Low Pass Filter Butterworth
 - d. RFT-06-B2 Low Pass Filter Chebyshev
 - e. RFT-06-C1 Band Pass Filter Butterworth
 - f. RFT-06-C2 Band Pass Filter Chebyshev
 - g. RFT-06-D Notch Filter

GPS Trainer

Order Code - 10212



Order Code - 10212 GPS Trainer Global Positioning System technology is rapidly changing how people find their way around the earth. Whether it is for fun, saving lives, getting there faster, or whatever uses you can dream up, GPS navigation is becoming more common everyday. GPS Trainer will provide a basic understanding of the GPS Fundamentals, Satellites & Design Aspects of GPS Receiver by actually connecting to the Satellite by GPS Antenna.

The Equipment is Useful for Students at B.Tech/B.S. & M.S level in engineering / technical institutes (EC & Telecom) Technical training centers in communication organizations, R&D personal and practicing engineering in research labs and industry.

Object:

Experiments that can be performed

01. Understanding concept of GPS
02. Establishing Link between GPS Satellite & GPS Trainer
03. Measurement of Latitude & Longitude
04. To Study Effect of DOP
05. Study of HDOP & VDOP
06. Analysis of Elevation Azimuth SNR
07. Study of PRN code
08. Study of Common NMEA Sentence Protocol like, GPGGA, GPGLL, GPGSA, GPGSV, GPRMC, GPVTG
09. Study of other GPS NMEA Sentences like, GPALM, GPRGS, GPGST, GPMSS, GPZDA
10. Study of useful Conversion formulas
11. Analysis of NMEA 0183 protocols
12. Study of UTC data and time

- Current (Avg.) : 180 mA
- Push Button for Reset
- Serial Communication : 4800 Baud (default)
- Protocol Messenger : NMEA 0183 V2.2, SIRF binary & RTCM SC-104V 2.0 type 1,2,9
- Maximum Altitude : 18000 meters (60,000 Feet) max.
- Maximum speed : 515 meters/sec. (1000 knots) max.
- Acceleration : 4g. maximum
- Jerk : 20 meters/sec-3 max.
- Time to First Fix : 45 / 38 / 8sec Cold/Warm/Hot Start
- PC Interface - RS 232 Port
- Operating Temperature : -40° C to +85° C

Specification & Features:

- Channel : 12
- Frequency : L1 C/A
- Position Accuracy : 25 meters CEP without SA
- Velocity Accuracy : 0.1 meters/second, without SA Off
- Time Accuracy : Synchronized to GPS time
- Update rate : 1/sec. (1 PPS) signal
- Receiver Sensitivity : -175 dBW
- Input Voltage : +5VDC

GPS Accessories:

01. Serial Cable M/F
02. Mains lead
03. GPS Antenna
04. Software CD



Digital Lab

Order Code - 33501



The DIGITAL LAB is intended for elementary as well as advance training of digital electronics. The digital lab covers regular digital circuits by solder-less interconnections on breadboard and as well as compatible with all optional modules through use of 2mm brass terminals and patch cords. Various clock generators, logic level input/output indicators and DC regulated power supplies etc. are in-built. The unit housed in attractive enclosure is supplied with mains cord, patch cords, Instruction manual and Component Set.

Features:

01. Logic gates operation
02. To verify De-morgan's theorem with boolean logic equations
03. Binary to Gray code conversion
04. Gray code to Binary conversion
05. Binary to Excess-3 code conversion
06. Binary Adder and Subtractor
07. Binary Multiplier
08. EX-OR gate implementation
09. Application of EX-OR gate
10. Johnson Counter
11. To verify the dual nature of Logic Gates
12. Study of Flip-Flops RS, JK, D&T
13. Multiplexer and Demultiplexer
14. 4 Bit Binary up and down counter
15. Study of 8 to 3 Line Encoder
16. Study of 3 to 8 Line Decoder
17. Study of Shift Register (SIPO)
18. CMOS-TTL Interfacing
19. Study of Crystal oscillator
20. Study of pulse stretcher circuit

Experimental Coverage:

Bread Board : Unique solder-less large size, spring loaded breadboard consisting of two Terminal Strips with 1280 tie points and 4 Distribution Strips with 100 tie points each, totaling to 1680 tie points. (Size : 112mm x 170mm approx)

Regulated DC Power Supply : +5V at 1 Amp, -5V at 500 mA, 3 to +15V at 500mA, and -3 to -15V at 500 mA.

Pulse Generator : 1 Hz to 1 MHz in 6 Steps. Variable in between steps

- Amplitude : 3-15V (CMOS), 5V (TTL)

- Duty Cycle : 50% TTL / CMOS Output

Pulsar Switches : 2 independent buffered bounce free manual pulser (useful for freezing the action of each stage of the counter after every clock pulse)

Data Switches : 12 Nos. independent buffered logic level inputs to select High / Low TTL levels, each with a bi-color LED to indicate high / low status and termination.

Logic Indicators : 12 Nos. independent buffered logic level indicators for High / Low status indication with bi-color LED for digital outputs

Seven Segment Display : 2 Nos. BCD to Seven Segment Decoder / Driver IC with terminals

Logic Probe : Logic level indicator for TTL / CMOS

CMOS/TTL : Provided

Power : 230 V \pm 10%, 50 Hz

Components Provided : ICs-4001/1, 4049/1, 4069/1, 7400/1, 7402/1, 7404/1, 7406/1, 7408/2, 7410/2, 7411/3, 7420/2, 7432/3, 7474/2, 7476/2, 7486/1. Resistors-330E/1, 1K/2, 1K8/1, 15K/1, 47K/1.1M/2, Capacitors-0.01mF/1, 0.1mF/1, 0.22 mF/1, Crystal-32.768MHz/1.

Accessories : Mains cord, Operating and Experimental manual, Red & Black patch cords (2mm with Pin) 10 each, Red & Black patch cord (Pin to Pin) 10 each. Wire 24/25 SWG. 1 Meter each 5 Colour Instruction manual : Strongly supported by detailed operating instructions.

Analog Lab

Order Code - 33502



ANALOGLAB is intended for elementary as well as advance training of analog electronics. The trainer covers regular analog circuits by solderless interconnections on breadboard and as well as compatible with all optional modules, through use of 2mm brass terminals and patch cords. Various DC regulated power supplies, Function Generator, DMM, Continuity Tester etc are in-built. The unit housed in attractive enclosure is supplied with mains cord, patch cords, Instruction manual and Component Set.

Experimental Coverage:

01. Study of Diodes in DC circuits
02. Study of Light Emitting Diodes in DC Circuits
03. Study of Half wave rectifier
04. Study of Full wave rectifier
05. Study of Zener Diode as a voltage regulator
06. Study of transistor series voltage regulator
07. Study of transistor shunt voltage regulator
08. Study of Low pass filter
09. Study of High pass filter.
10. Study of band pass filter
11. Study of CE configuration of NPN transistor
12. Study of CB configuration of NPN transistor
13. Study of CE amplifier
14. Study of Monostable multivibrator using transistor
15. Study of Bistable multivibrator using transistor
16. Study of Astable multivibrator using transistor
17. Study of CB Amplifier (PNP)
18. Study of CC Amplifier (PNP)
19. Transistor Audio Amplifier
20. Two Stage R.C. Coupled Transistor
21. Inverting Amplifier
22. Non-inverting Amplifier
23. Integrating Amplifier for A.C input Signal
24. Differentiator Amplifier
25. Square Wave Generator

Features:

Bread Board : Unique solder-less large size, spring loaded breadboard consisting of two Terminal Strips with 1280 tie points and 4 Distribution Strips with 100 tie points each, totaling to 1680 tie points. (Size:112mm x 170mm approx)

Regulated DC Power Supply : +5V at 1 Amp, -5V at

1Amp, +12V/0 to 20V at 500mA, and -12 V/0 to -20V at 500 mA

AC Supply : 5-0-5V, 10-0-10V at 100mA. Can be used as 5V,10V,15V,20V and also as center tap

Function Generator : Sine / Square / Triangular waveforms frequency 1 Hz to 110 KHz in 5 Steps. Variable in between steps. Sine / Square / Triangular waveform output 50mV ~10Vpp variable

Modulation Generator : Sine / Square / Triangular wave forms frequency 1 Hz to 110 KHz in 5 Steps. Variable in between (100 KHz) steps. Sine / Square / Triangular waveform output 50mV ~ 10Vpp variable with 100 Khz Modulation

Digital Meter (3½Digit) : Dual range DC voltmeter 0-20 V / Ammeter 0-200mA

Continuity Tester : For testing the continuity. Provided with Beeper Sound

Potentiometers : 3 Potentiometers (1K, 100K and 100K) with terminals

On Board Switches : 2 Switches Single pole double through

Power : 230 V ± 10%, 50 Hz

Components Provided : Resistance ± 5% 1W 100E/1, ½ W 47E/2,100E/1, 220E/1, 390E/1,1K/1,¼W 100E/1, 220E/2, 270E/1, 330E/, 1K/3, 2K2/2, 3K3/1, 4K7/2, 5K1/1, 5K6/1, 10K/2, 12K/1, 15K/2, 47K/2, 68K/1, 100K/4, 180K/2, 220K/1 Capacitor 0.1uF/1, 0.22uF/3, 10uF/25V/3, 22uF/25V/2, 47uF/25V/2, 100uF/25V/1, Diode 1N 4007/4, LED 5mm Red/1, Zener Diode 5V6/400mW/1, Transistor SL 100/1, SK 100/1, BC 107/2, BC 177/2, IC 741/2

Accessories : Mains cord, Operating and Experimental manual, Red & Black patch cords (2mm with Pin) 10 each, Red & Black patch cord (Pin to Pin) 10 each & Component Set Instruction manual : Strongly supported by detailed operating instructions * Weight : 5 Kg. (Approx.) * Dimension : W 412 x H 150 x D 310

Optional Modules:

Apart from above given experimental coverage of 25 experiments on breadboard, customers can purchase these optional modules. These are ready to use modules with wired components & circuit schematic drawn on top compatible to use with Analog Lab.

- 36001 Study of Diodes in DC circuits
- 36002 Study of Light Emitting Diodes in DC Circuits
- 36003 Study of Half wave rectifier
- 36004 Study of Full wave rectifier
- 36005 Study of Zener Diode as a voltage regulator
- 36006 Study of transistor series voltage regulator
- 36007 Study of transistor shunt voltage regulator
- 36008 Study of Low pass filter
- 36009 Study of High pass filter
- 36010 Study of band pass filter
- 36011 Study of CE configuration of NPN transistor
- 36012 Study of CB configuration of NPN transistor
- 36013 Study of CE amplifier
- 36014 Study of Monostable multivibrator using transistor
- 36015 Study of Bistable multivibrator using transistor
- 36016 Study of Astable multivibrator using transistor
- 36017 Study CB amplifier (PNP)
- 36018 Study CC amplifier (PNP)
- 36019 Study Zener diode voltage regulator
- 36020 Study power supply having two zener diodes in series
- 36021 Study dual polarity voltage regulated supply
- 36022 Plot V / I of LED

- 36023 To practically understood the operation of a 7-segment LED display
- 36024 To Study CC characteristics of NPN transistor
- 36025 To study CE characteristics of PNP transistor
- 36026 To study CB characteristics of PNP transistor
- 36027 To study CC characteristics of PNP transistor
- 36028 Study full wave dual supplies
- 36029 FETcharacteristic
- 36030 Verify superposition theorem
- 36031 Verify thevenin's theorem
- 36032 Verify receprocity theorem
- 36033 Phase shift oscillator
- 36034 Verify kirchoff 's law (V& I)
- 36035 Ohm's law
- 36036 Ideal resistance
- 36037 Resistance in series
- 36038 Resistance in parallel
- 36039 Verification of maximum power transfer theorem

Digital- Analog Lab

Order Code - 33503



The DIGITAL-ANALOG LAB is intended for elementary as well as advance training of Digital & Analog electronics. The trainer covers regular digital & analog circuits by solder-less interconnections on breadboard and as well as compatible with all optional modules, through use of 2mm brass terminals and patch cords. Various clock generators, logic level input/output indicators and DC regulated power supplies etc. are in-built. The unit housed in attractive enclosure is supplied with mains cord, patch cords, Instruction manual and Component Set.

Experimental Coverage:

Analog

01. Study of Diodes in DC circuits
02. Study of Light Emitting Diodes in DC Circuits
03. Study of Half wave rectifier
04. Study of Full wave rectifier
05. Study of Zener Diode as a voltage regulator
06. Study of transistor series voltage regulator
07. Study of transistor shunt voltage regulator
08. Study of Low pass filter
09. Study of High pass filter
10. Study of band pass filter
11. Study of CE configuration of NPN transistor
12. Study of CB configuration of NPN transistor
13. Study of CE amplifier
14. Study of Monostable multivibrator using transistor
15. Study of Bistable multivibrator using transistor
16. Study of Astable multivibrator using transistor

Digital

01. Logic gates operation
02. To verify De-morgan's theorem With boolean logic equations
03. Binary to Gray code conversion
04. Gray code to Binary conversion
05. Binary to Excess-3 code conversion
06. Binary Addition and Subtractor
07. Binary Multiplier

08. EX-OR gate implementation
09. Application of EX-OR gate
10. Johnson Counter
11. To verify the dual nature of Logic Gates
12. Study of Flip-Flops RS, JK, D&T
13. Multiplexer and Demultiplexer
14. 4 Bit Binary up and down counter
15. Study of 8 to 3 Line Encoder
16. Study of 3 to 8 Line Decoder
17. Study of Shift Register (SIPO)
18. CMOS-TTL Interfacing
19. Study of Crystal oscillator
20. Study of pulse stretcher circuit

Features:

Bread Board : Unique solder-less large size, spring loaded breadboard consisting of two Terminal Strips with 1280 tie points and 4 Distribution Strip with 100 tie points each, totaling to 1680 tie points. (Size:112mm x170mm)

Regulated DC Power Supply : +5 V at 1 Amp, -5 V at 1Amp, +12 V/ 0 to 20V at 500mA, and -12 V/ 0 to -20 V at 500 mA

AC Supply : 5-0-5V, 10-0-10V at 100mA. Can be used as 5V, 10V, 15V, 20V, and also as center tap

Function Generator : Sine / Square / Traingular / Pulse waveform frequency 1 Hz to 110 KHz in 5 Steps. Variable in between steps. Sine / Square / Traingular waveform output 50mV ~ 10Vpp variable

Clock Generators : 0.1Hz and 100 Hz, Independent fixed TTL 5V outputs

Variable Clock Generators : low frequency variable clock 1 Hz to 10 Hz Fixed TTL 5V output

Pulser Switch : 2 independent buffered bounce free manual pulser (useful for freezing the action of each stage of the counter after every clock pulse)

Data Switch : 16 independent logic level inputs to select High / Low TTL levels, each with a LED to indicate high / low status and termination

Logic Indicators : 16 independent buffered logic level indicators for High / Low status indication of digital outputs

Speaker : 8 ohms miniature speaker with terminations

Digital meter (3½Digit) : Dual range DC Voltmeter 0-20V / Ammeter 0-200mA

Continuity Tester : For testing the continuity. Provided with Beeper Sound

Potentiometers : 6 Potentiometers (1K, 22K, 47k, 100K, 100K and 1Meg) with terminals

BNC to banana adapter : 2 Nos. BNC to 2 channel banana adapter

Computer interface : Facilities connecting your trainer to either Rs232 communication port of PC ADAPTER using 25 pin (male) connector through 25 nos. of 2 mm banana sockets

On Board Switches : 2 Switches singal pole double through

Connecting terminals : 2 / 4 connecting terminals

Seven segment LED Display : 2 Nos. BCD to Seven Segment Decoder/ Driver IC with terminals

LED Bar Graph : With 10 LED Indicators and 20 termination

Logic Probe : Logic level indicator for TTL/CMOS

Power : 230 V ± 10%, 50 Hz

Accessories : Mains cord, Operating and Experimental manual, Red & Black patch cords (2mm with Pin) 10 each, Red & Black patch cord (Pin to Pin) 10 each & Component Set Instruction manual : Strongly

supported by detailed operating instructions

* Weight : 6 Kg. (Approx)

* Dimension : W 412 x H 150 x D 310

Optional Modules:

Analog

Apart from above given experimental coverage of 16 + 20 experiments on breadboard, customers can purchase these optional modules. These are ready to use modules with wired components & circuit schematic drawn on top compatible to use with Digital-Analog Lab. Apart from above given experimental coverage of 16 + 20 experiments on breadboard, customers can purchase these optional modules. These are ready to use modules with wired components & circuit schematic drawn on top compatible to use with Digital-Analog Lab.

- 36001 Study of Diode in DC circuits
- 36002 Study of Light Emitting Diodes in DC Circuits
- 36003 Study of Half wave rectifier
- 36004 Study of Full wave rectifier
- 36005 Study of Zener Diode as a voltage regulator
- 36006 Study of transistor series voltage regulator
- 36007 Study of transistor shunt voltage regulator
- 36008 Study of Low pass filter
- 36009 Study of High pass filter
- 36010 Study of band pass filter
- 36011 Study of CE configuration of NPN transistor
- 36012 Study of CB configuration of NPN transistor
- 36013 Study of CE amplifier
- 36014 Study of Monostable multivibrator using transistor
- 36015 Study of Bistable multivibrator using transistor
- 36016 Study of Astable multivibrator using transistor
- 36017 Study CB amplifier (PNP)
- 36018 Study CC amplifier (PNP)
- 36019 Study of FET amplifier.
- 36020 Study power supply having two zener diodes in series
- 36021 Study dual polarity voltage regulated power supply
- 36022 To study the characteristics of photo transistor
- 36023 To practically understood the operation of a 7-segment LED display
- 36024 To Study CC configuration of NPN transistor
- 36025 To study CE configuration of PNP transistor
- 36026 To study CB configuration of PNP transistor
- 36027 To study CC configuration of PNP transistor
- 36028 Study full wave dual polarity supplies
- 36029 Study of FET characterstic
- 36030 Verify superposition theorem
- 36031 Verify thevonin's theorem
- 36032 Verify receprocity theorem
- 36033 Study of Phase shift audio oscillator
- 36034 Verify kirchoff 's law (V&I)
- 36035 Verify ohm's law
- 36036 Ideal resistance characteristics
- 36037 Verification of series law of resistance
- 36038 Verification of parallel law of resistance
- 36039 Verification of maximum power transfer theorem

* Weight : 0.7 Kg. (Approx)

* Dimension : W 176 x H 131 x D 37

Digital

- 38501 Logic gates operation
- 38502 To verify De-morgan's theorem with boolean logic equations
- 38503 Binary to Gray code conversion
- 38504 Gray code to Binary conversion

- 38505 Binary to Excess-3 code conversion
- 38506 Binary Adder and Subtractor
- 38507 Binary Multiplier
- 38508 EX-OR gate implementation
- 38509 Application of EX-OR gate
- 38510 Johnson Counter
- 38511 To verify the dual nature of Logic Gates
- 38512 Study of Flip-Flops RS, JK, D&T
- 38513 Multiplexer and Demultiplexer
- 38514 4 Bit Binary up and down counter
- 38515 Study of 8 to 3 Line Encoder
- 38516 Study of 3 to 8 Line Decoder
- 38517 Study of Shift Register (SIPO)
- 38518 CMOS-TTL Interfacing
- 38519 Study of Crystal oscillator
- 38520 Study of pulse stretcher circuit
- 38521 4 Bit Ring Counter
- 38522 Modulo 12 Counter By Direct Clearing
- 38523 Decade counter
- 38524 Shift Register SISO and PIPO
- 38525 Decimal to BCD Converter
- 38526 Astable Multivibrator using Digital IC
- 38527 Bistable Multivibrator using Digital IC
- 38528 Monostable Multivibrator using Digital IC
- 38529 Octal to binary Encoder
- 38530 4 Bit Magnitude Comparator
- 38531 Interface of TTL-IC to CMOS-IC & CMOS IC to TTL-IC

Digital Trainer

Order Code - 33504



Digital Trainer is intended for elementary as well as advance training of Digital electronics and for bread board digital circuits, AND, OR, NOT, NAND, NOR, XOR, Three State Buffer, RS Latch, JK Flip Flop, Monostable Multivibrator. and UP/ DOWN Counter. Practical experience on this board carries great educative value for R & D labs, Science and Engineering Students.

Specifications:

- Breadboard : Solderless Bread board with 1680 inter connected Tie Points
- Pulse Switches : 2 No's. Bounce free push buttons
- Logic Switches : 8 logic level Switches in Dip type .
- Power Supply : Fixed: +5V at 750 mA
- Power Sockets : Logic Probe Power Supply Sockets
- Logic Input : 8 LED buffered logic level indicators
- Variable Clock : Fine adjustment of clock frequency.
- Clock range selection L : 10 – 40 Hz, H : 1K – 20K Hz.
- Jacks : 2mm to BNC Socket 2 No. 2mm to 4mm Socket 2 No.
- Components Provided : ICs - 4001/1, 7400/3, 7402/1, 7404/1, 7408/1, 7432/1, 7476/2, 7486/1, 74126/1, Resistors 1/4W ±5% 230E/1, 10K/1, 39K/1, LED 5mm/1

Accessories : Mains cord, 2mm Red & Black patch cords 5 each and 2mm to 1mm Red & Black 5 each Instruction manual : Strongly supported by detailed operating instructions.

Logic Probe : 1 Pc Provided

- * Wiring of all types of experiments become simple and less time consuming.
- * The unit is operative on 230V ±10% at 50Hz AC Mains.

Experiment Coverage:

01. LED Display
02. Getting a Pulse
03. Setting a Logic Level
04. Getting a Clock and using the Logic Probe
05. AND Gate (static operation)
06. OR Gate (static operation)
07. Dynamic Operation of AND Gate and OR Gate
08. NOT Gate
09. NAND Gate 10. NOR Gate
11. Exclusive OR Gate (Also called XOR Gate)
12. XNOR
13. Three State Buffer
14. RS Latch
15. Basic JK Flip Flop
16. Monostable Multivibrator
17. Asynchronous UP/DOWN Counter

Specifications of Logic Probe Order Code - 16905

01. OPERATING VOLTAGE : 5V ± 3% regulated DC at 150mA, Ripple < 3mV.
02. LOGIC STATE INDICATIONS
 01. High Level '1' : 'H' (HIGH).
 02. Low Level '0' : 'L' (LOW).
 03. Open / Floating state : 'O' (OPEN).
 04. Pulses : 'P' (PULSES).
03. LOGIC FAMILIES : TTL / CMOS.
04. FREQUENCY : Upto 50MHz for TTL/CMOS.
05. RECOGNISED VOLTAGE LEVELS BY LOGIC PROBE AT AN OPERATING VOLTAGE OF 5V ±3% RIPPLE < 3mV
 01. High Level Threshold : > 3.0V
 02. Low Level Threshold : < 0.8V
 03. Open/Floating Level : 0.8V to 3.0V (Approx.)
 04. Over Load Protection : Upto 25V source
 05. Sink Current : Less than 15mA
06. SUPPLY CURRENT TAKEN BY THE PROBE : Less than 150mA
07. SHORTEST PULSE WHICH CAN BE DETECTED BY THE PROBE : 40 nano Sec.
08. Pulse detection is retriggerable and hence continuous pulses or clock will be indicated by 'P'.
09. Positive going pulse will be indicated by letter 'L' followed by letter 'P' and then 'L' again.
10. Negative going pulse will be indicated by the letter 'H' followed by letter 'P' and then 'H' again.
11. THE INDICATOR 'O' OCCURS IN TWO SITUATIONS
 01. When the probe tip is not connected to a test point
 02. When the test point is floating with a level lying between about 0.8V to 3V

Logic Lab

Order Code - 33505



Logic Trainer is designed for the logic beginners to enhance the comprehension of basic logical theory. The digital lab covers regular digital circuits by solder-less interconnections on breadboard and as well as compatible with all optional modules through use of 2mm brass terminals and patch cords. The design of the equipment is easy to operate and understand. It is equipped with various kinds of basic logic gates, debounced logical switches, LED indicators, DC power supply with short circuit protection, pulse generator and solderless bread board. The unit housed in attractive enclosure is supplied with mains cord, patch cords, Instruction manual.

Learners in high schools, Polytechnic Colleges and Universities, can use the trainer as independent activity tool.

Experimental Coverage:

01. Logic gates operation
02. To prove De-morgan's theorem with boolean logic equations
03. Binary to Gray code conversion
04. Gray code to Binary conversion
05. Binary to Excess-3 code conversion
06. Binary Adder and Subtractor
07. Binary Multiplier
08. EX-OR gate implementation
09. Application of EX-OR gate
10. To verify the dual nature of Logic Gates
11. Study of Flip-Flops RS, JK,

Specifications:

Basic Logic

Gate Units : It contains 6 kinds of logic gates, i.e. AND GATE X 6, OR GATE X 6, NAND GATE X 6, NOR GATE X 6, XOR GATE X 3, NOT GATE X 3. Input voltage of HI level > 2.25V Input voltage of LO level < 0.8V

DC Power Supply : Equipped with short circuit protection and indicator.

- a. Output voltage $+5V \pm 5\%$
Max. output current 1 Amp.
Line regulation < 50mV
Load regulation < 100mV
- b. Output voltage $-5V \pm 5\%$
Max. output current 500 mA
Line regulation < 25mV
Load regulation < 30mV
- c. Output voltage $\pm 15V \pm 5\%$
Max. output current 500 mA
Line regulation < 150mV
Load regulation < 150mV

Pulse Generator: 3 kinds of time interval, 1 sec, 0.1 sec, 0.01 sec. Output voltage +5V Debounced

Logic Switch : 4 No's HI / LO

LED Indicator : 8 Bits LED Output Indicator, Max. Input Voltage <= 15V DC

Breadboard : Interconnected Solder less Breadboard having 2120 tie points, fitting all DIP sizes and all components with lead and solid wire AWG # 22-30 (0.3 – 0.8 mm)

Accessories : Mains Cord, Instruction Manual, Red & Black patch cords (2mm with Pin) 10 each, Red & Black patch cord (Pin

to Pin) 10 each. Wire 24/25 SWG. 1Meter each 5 Colour

Digital Lab Station

Order Code - 33506



DIGITAL LAB STATION is designed for the logic beginners to enhance the comprehension of basic logical theory. The digital lab covers regular digital circuits by solder-less interconnections on breadboard and as well as compatible with all optional modules through use of 2mm brass terminals and patch cords. The design of the equipment is easy to operate and understand. It is equipped with various kinds of basic logic gates, debounced logical switches, LED indicators, DC power supply with short circuit protection, pulse generator and solderless breadboard. The unit housed in attractive enclosure is supplied with mains cord, patch cords, Instruction manual.

Learners in high schools, Polytechnic Colleges and Universities, can use the trainer as independent activity tool.

Experimental Coverage:

01. Logic gates operation
02. To prove De-morgan's theorem With boolean logic equations
03. Binary to Gray code conversion
04. Gray code to Binary conversion
05. Binary to Excess-3 code conversion
06. Binary Adder and Subtractor
07. Binary Multiplier
08. EX-OR gate implementation
09. Application of EX-OR gate
10. Johnson Counter
11. To verify the dual nature of Logic Gates
12. Study of Flip-Flops RS, JK, D&T
13. Multiplexer and Demultiplexer
14. 4 Bit Binary up and down counter
15. Study of 8 to 3 Line Encoder
16. Study of 3 to 8 Line Decoder
17. Study of Shift Register (SIPO)
18. CMOS-TTL Interfacing
19. Study of Crystal oscillator
20. Study of pulse stretcher circuit
21. 4 Bit Ring Counter
22. Modulo 12 Counter By Direct Clearing
23. Decade counter
24. Shift Register SISO and PIPO

1. SOLDER LESS BREADBOARD

: Interconnected nickel plated with a total of 2120 tie points in total, fitting all DIP sizes and components with lead and solid wire in diameter of AWG #22-30 (0.3 - 0.8mm)

2. DC POWER SUPPLY

: Variable DC power :
Positive output voltage: 0 to +15V
Negative output voltage: 0 to - 15V

Maximum output Current : 300 mA
 Line regulation : < 0.05%/V (Ta=25°C)
 Load regulation : < 30 mV (Ta=25°C)
 Fixed power supply:
 Positive output Voltage : 5V ± 0.25V
 Maximum output Current : 1 Amp
 Line regulation : < 50 mV
 Load regulation : < 100 mV
 Negative output Voltage : -5V ± 0.25V
 Maximum output Current : 100 mA
 Line regulation : < 25 mV
 Load regulation : < 30 mV

All DC Power Supplies are equipped with short circuit protection.

3. FUNCTION GENERATOR : Frequency ranges:
 1Hz - 11Hz
 10Hz - 110Hz
 100Hz - 1K1KHz
 1KHz - 11KHz
 10KHz - 110KHz

Sine wave output : 0 to 8 Vp-p variable

Triangle wave output : 0 to 6 Vp-p variable

Square wave output : 0 to 8 Vp-p variable

4. DIGITALVOLTMETER : 3 1/2 digits LED display
 4 ranges:
 0 - 199.9V full scale
 0 - 19.99V full scale
 0 - 1.999V full scale
 0 - 199.9mV full scale

Input impedance : 10 Meg. Ohm for any range

- 5. TWO DIGIT SEVEN SEGMENT LED DISPLAY COMMON CATHODE
- 6. FOUR POINTTIP/ BANANA SOCKET / BNC SOCKET EXCHANGE ADAPTERS
- 7. EIGHT BUFFERED LED DISPLAY
- 8. EIGHT DATA SWITCH
- 9. TWO FUNCTION SWITCHES
- 10. TWO PULSE SWITCH

Power Project Board

Order Code - 33507



Power Project Board System has been designed to provide instant circuit construction without soldering on the bread board area .Learners can insert components directly on breadboard and make all interconnections as required with 24 Swg (Gauge) solid wire. Within few minutes they can complete their projects/design on the same. Your precious IC's are not damaged & are instantly reusable, No expensive special jumpers are required. You can insert all components directly without any adapters i.e. IC's such as types 8, 14, 16, 20 or 40 pin DIP units, LSI's and all discrete components with lead diameter upto 0.56mm (24 Swg).

Features:

- 01. Breadboard : Unique solder-less large size, spring loaded breadboard consisting of 3 Terminal Strips with 1920 tie points and 5 Distribution Strips with 500 tie points , totaling to 2420 tie points.
- 02. Power Supply

Fixed DC Power Supply : 5 V at 1 Amp.

Variable DC Power Supply : ± 0 to 15 V at 500 mA

- 03. Mains On/Off Illuminated Switch
- 04. Accessories : Mains Lead, Operating Manual, Adequate no. of patch cords (Total 26)
- * The unit is operative on 230V ±10% at 50Hz A.C. Mains.
- * Good Quality, reliable terminal/sockets are provided at appropriate places on panel for connections & observation of waveforms.

Power Project Board (I.C. Bread Board Systems)

Order Code - 33507A-C



Order Code - 33507A, I.C. Bread Board Systems have been designed to provide instant circuit construction without soldering on the bread board area .Learners can insert components directly on breadboard and make all interconnections as required with 24 Swg (Gauge) solid wire. Within few minutes they can complete their projects/design on the same. Your precious IC's are not damaged & are instantly reusable, No expensive special jumpers are required. You can insert all components directly without any adapters i.e. IC's such as types 8, 14, 16, 20 or 40 pin DIP units, LSI's and all discrete components with lead diameter upto 0.56mm (24 Swg).

SN. ORDER
 01 **33507A**

CODE CONFIGURATION

Two full terminal strips, Tie points 1280, One distribution strip, Tie points 100, (total of 1380 tie/contact points) and two terminals (Binding Posts)

02 **33507B**

Two full terminal strips, Tie points 1280, Three distribution strips, Tie points 300 (total of 1580 tie/contact points) and three terminals (Binding Posts)

03 **33507C**

Two full terminal strips, Tie points 1280, Four Distribution strips, Tie points 400 (total of 1680 tie/contact points) and three terminals (Binding Posts).

POWER REQUIREMENT : 230V±10% at 50 Hz A.C. Mains
 Strongly supported by detailed Operating Instructions.

Bread Board Circuit Lab

Order Code - 33508



The Bread Board Circuit Lab is intended for elementary as well as advance training of analog electronics. The trainer cover regular analog circuits by solder less inter connections through use of 2 mm brass terminations & patch cords. Various AC & DC regulated power supply in built. The unit is housed in sunmica finished wooden

enclosure with provision for safe keeping of mains cord, patch cords and top lid for protection during storage.

The Trainer CoverThe Following Experiment :

01. Study of basic gates and verification of their truth tables:
02. Study and verifications of the law of Boolean algebra and De-Morgan's Theorems.
03. Study of important TTL terminologies. Verification of important TTL Circuit parameters.
04. Construction and verification of various types of flip-flops using gates and IC's :
05. Construction and verification of various types of combinational circuits :
06. Construction and verification of various types of counters :
07. Construction and Verification of 4 Bit Universal Shift Register :
08. Many other experiments are possible using the onboard components and Bread board .

Feature:

01. Bread boards : Unique solder-less large size, spring loaded breadboard consisting of two Terminal Strips with 1280 tie points and 4 Distribution Strips with 100 tie points each, totaling to 1680 tie points. (Size:112mm x 170mm approx)
02. IC based DC Reg. : (a). +12 V / 500 mA (fixed and with facility to vary from 0 to +12 V).
03. Power Supplies : (b). -12 V / 500 mA (fixed and with facility to vary from 0 to -12 V). : (c). + 5V \pm 0.25V / 500mA (fixed).
04. Digital meters : (a). Dual range DC voltmeter (20 V / 200V). (3.5 Digit) : (b). Dual range DC current meter (200 mA / 2A).
05. Continuity Tester : Audio / Visual indication.
06. Clock Generators : (a). 0.1Hz, b. 1Hz, c. 100Hz, d. 1KHz. Simultaneous independent fixed TTL (5V) outputs.
07. Manual Pulser : One independent buffered bounce less manual pulser (useful for freezing the action of each stage of the counter after every clockpulse)
08. Logic Level Inputs : Eight independent buffered logic level inputs to select High / Low TTL levels, each with a LED to indicate high / low status and termination.
09. Logic Level : Eight independent buffered logic level indicators for High/Low status indication Indicators of digital outputs.
10. AC Supplies : 9 - 0 - 9 VAC / 500 mA.
11. Speaker : 8 ohms miniature speaker with terminations.
12. Potentiometers : 3 Potentiometers (1K, 10K and 100K) with terminations.
13. Power ON : Power ON switch with indicator for mains on indication and fuse for protection.
14. Patch Cords :
 - a. Set of 25 assorted coloured single stand hook - up wires.
 - b. Set of 15 assorted coloured multi - stand wires with 2mm stackable plug termination at one end & hook-up wire termination at the other end.
15. Components provided : IC-7400/1, 7402/1, 7408/1, 7432/1, 7404/1, 7490/1, 7495/1, 7486/1, 7476/2, 7410/2.
16. Power Requirement : 230V + 10% single phase AC.

Digital Electronic Trainer

Order Code - 33509



The Digital Electronic Trainer is intended for elementary as well as advance training of digital electronics. The trainer cover regular digital circuits by solder less inter connections through use of 2 mm brass terminations and patch cords. Various clock generators, logic level input / output indicators and DC regulated power supply are in built. The unit housed in sunmica finished wooden box enclosure with provision for safe keeping of mains cord, patch cords and top lid for protection during storage.

The Trainer CoverThe Following Experiment :

01. Study of basic gates and verification of their truth tables:

1.1 NOT	1.2 OR	1.3 AND	1.4 NOR
1.5 NAND	1.6 EX-OR	1.7 EX-NOR	
02. Study and verifications of the law of Boolean algebra and De-Morgan's Theorems.
03. Study of important TTL terminologies. Verification of important TTL Circuit parameters.
04. Construction and verification of various types of flip-flops using gates and IC's :

4.1 RS Flip-flop	4.2 J-K Flip-flop
4.3 D Flip-flop	4.4 T Flip-flop
05. Construction and verification of various types of combinational circuits :

5.1 Half Adder	5.2 Full Adder
5.3 Half Subtractor	5.4 Full subtractor
5.5 Even / Odd Parity Checker	
5.6 Multiplexer	5.7 Demultiplexer
5.8 Binary to Gray Converter	
5.9 Gray to Binary Converter	
5.10 2 Bit Comparator	
06. Construction and verification of various types of counters :

6.1 Down Counter	
6.2.1 3 Bit Synchronous Ripple UP Counter	
6.2.2 3 Bit Asynchronous Ripple UP Counter	
6.3 Ring Counter	6.4.1 Decade Counter
6.4.2 Decade Counter using IC 7490	
07. Construction and verification of 4 Bit Universal Shift Register :

7.1 Parallel Input Parallel Output(Parallel load operation)
7.2 Shift Right Operation (Serial Input serial Output)
7.3 Shift Left Shift Register
08. Study of 7 - Segment Display And Decoder / Driver.
09. Many other experiments are possible using the onboard components and Bread board .

Feature:

01. Breadboards : Unique solder - less large size, spring loaded breadboard consisting of one Terminal Strips with 640 tie points each and 2 Distribution Strips with 100 tie points each, totaling to 840 tie points. (size:55mm X 170mm approx).
02. DC Power Supply : 5 V \pm 0.25V / 500 mA (IC based regulated output).

03. Clock Generators : i. Fixed : a. 0.1Hz b. 1Hz. (Simultaneous independent outputs).
04. (TTL, 5V) : ii. Variable : One low frequency variable clock generator.
05. Manual Pulser : One independent bounce less manual pulser (useful for freezing the action of each stage of the counter after every clock pulse).
06. Logic Level Inputs : Eight independent logic level inputs to select High / Low TTL levels, each with a LED to indicate high / low status and termination.
07. Logic Level : Eight independent buffered logic level indicators for High / Low status
08. Indicators : indication of digital outputs.
09. Seven segment decoder : One BCD to Seven Segment Decoder/ Driver IC with terminations.
11. Continuity Tester : Audio / Visual indication.
12. ZIF socket : IC's up to 40 pin Universal ZIF Socket (without soldering)
13. Potentiometer : One Potentiometer (100K) with terminations.
14. Power ON : Power ON switch with indicator for mains on indication and fuse for protection.
15. Patch Cords : Set of 20 assorted coloured multi-stand wires with 2mm stackable plug termination at both ends.(Stackable)
16. Power Requirement : 230V + 10% single phase AC.
17. Instruction manual : One detailed instruction manual with well thought out experiments covering the above topics.

Digital Logic Trainer (TTL) / Logic Trainer Board (Based on 74 Series)

Order Code - 33510



Digital Logic Trainer (TTL) / Logic Trainer Board based on 74 series has been designed specifically to make the students familiar with the study of TTL ICs and verification of the truth table of logic gates, flip-flops, Gated & Master Slave JK flip-flops, Schmitt Trigger, Expanders, Binary address, Counters, Shift registers, Multiplexer (Encoder), Demultiplexer (Decoder), 8 Bit D/A Converter and 8 Bit A/D Converter etc. Large area of Bread Board is provided on the front panel for ICs. Students can make the circuit easily on the Bread Board with the help of other accessories which are provided on the front panel of Digital Logic Trainer.

Practical experience on this trainer/board carries great educative value for Science and Engineering Students.

Specifications:

01. OUTPUT D.C. VOLTAGE : Fixed 5V and 0 - $\pm 18V$.
02. OUTPUT CURRENT: 1 Amp.
03. LOAD REGULATION : $\pm 1\%$ of the highest specified output voltage. (NO LOAD TO FULL LOAD)
04. RIPPLE AND NOISE : less than 2 mV.
05. VARIABLE CLOCK FREQUENCY : 1 Hz to 1 MHz by three frequency range & multiplier.
06. LOGIC INPUTS : 16 switches for High/Low
07. OUTPUT INDICATORS : 16, 5 mm bright Red LEDs.
08. SEVEN SEGMENT DISPLAY : 4 digit seven segment display with decoder driver.
09. DIGITAL VOLTMETER : Digital DC voltmeter range

0 - 20V.

10. OPERATING CONDITIONS : 0 to 40°C and 95% R.H. at 40°C.
11. BREAD BOARD : Unique solder - less large size, spring loaded breadboard consisting of 2 Terminal Strips with 640 tie points each and 4 Distribution Strips with 100 tie points each, totalling to 1680 tie points.
12. INPUT VOLTAGE : 230V $\pm 10\%$ at 50 Hz A.C. Mains.
13. ICs PROVIDED : 29 ICs have been provided.

Note: Following ICs or equivalent can be provided.

SN. LOGIC I.C. NO.

01. QUAD 2-INPUT NAND GATE 7400
 02. QUAD 2-INPUT NOR GATE 7402
 03. HEX INVERTER 7404
 04. QUAD 2-INPUT AND GATE 7408
 05. DUAL 4-INPUT NAND SCHMITT TRIGGER 7413
 06. QUAD 2-INPUT OR GATE 7432
 07. EXPENDABLE DUAL 2-WIDE 2-INPUT AOI GATE 7450
 08. DUAL 4-INPUT EXPANDER 7460
 09. EDGE - TRIGGERED FLIP-FLOP 7470
 10. DUAL JK M/S FLIP-FLOP 4027
 11. DUAL JK-FLIP-FLOP 7473
 12. 4 BIT FULL ADDER 7483
 13. QUAD 2-INPUT EXCLUSIVE OR-GATE 7486
 14. DECADE COUNTER 7490
 15. DIVIDE-BY-TWELVE COUNTER 7492
 16. 4-BIT BINARY RIPPLE COUNTER 7493
 17. 4-BIT SHIFT REGISTER 7495
 18. QUAD 3-STATE BUFFER 74126
 19. 8-INPUT MULTIPLEXER 74151
 20. 1-OF-16 DECODER/DEMULTIPLEXER 74154
 21. 8-BIT D/A CONVERTER DAC 0808
 22. 8-BIT A/D CONVERTER ADC 0808
- * Strongly supported by detailed Operating Instructions, giving details of Object, Theory, Design procedures, Report Suggestions and Book.

Digital Logic Trainer (cmos) / Logic Trainer Board (based On 74 C/4000 Series)

Order Code - 33511



Digital Logic Trainer (CMOS) / Logic Trainer Board based on 74 C/4000 series has been designed to make the students familiar with the study of CMOS ICs and verification of the truth tables of logic gates, flip-flops, Gated & Master Slave JK flip-flops, Schmitt Trigger, Expanders, Binary address, Counters, Shift registers, Multiplexer (Encoder), Demultiplexer (Decoder), 8 Bit D/A Converter and 8 Bit A/D Converter etc. Large area of Bread Board is provided on the front panel for ICs. Students can make easily the circuit on the bread board with the help of other accessories which are provided on the front panel of Digital Logic Trainer. The logic trainer board is quite educative and is a must for Science and Engineering Students.

Specifications:

01. OUTPUT D.C. VOLTAGE : Fixed 5V, Variable 0 to

- ±18 V.
- 02. OUTPUT CURRENT: 1 Amp.
- 03. LOAD REGULATION : ±1% of the highest specified output voltage. (NO LOAD TO FULL LOAD)
- 04. RIPPLE AND NOISE : less than 2 mV.
- 05. VARIABLE CLOCK FREQUENCY : 1 Hz to 1 MHz by three frequency range & multiplier.
- 06. LOGIC INPUTS : 16 switches for High/Low
- 07. OUTPUT INDICATORS : 16, 5 mm bright Red LEDs.
- 08. SEVEN SEGMENT DISPLAY : 4 digit seven segment display with decoder driver.
- 09. DIGITAL VOLTMETER : Digital DC voltmeter range 0 - 20V.
- 10. OPERATING CONDITIONS : 0 to 40°C and 95% R.H. at 40°C.
- 11. BREAD BOARD : Unique solder - less large size, spring loaded breadboard consisting of 2 Terminal Strips with 640 tie points each and 4 Distribution Strips with 100 tie points each, totalling to 1680 tie points.
- 12. INPUT VOLTAGE : 230V ±10% at 50 Hz A.C. Mains.
- 13. ICs PROVIDED : 29 ICs have been provided.

Note: Following ICs or equivalent will be provided.

SN. LOGIC I.C. NO.

01. QUAD 2-INPUT NAND GATE 74C00
 02. QUAD 2-INPUT NOR GATE 74C02
 03. INVERTER CIRCUIT 4069
 04. QUAD 2-INPUT AND GATE 74C08
 05. QUAD 2-INPUT NAND SCHMITT TRIGGER 4093
 06. QUAD 2-INPUT OR GATE 74C32
 07. DUAL 2-WIDE 2-I/P AOI GATE 4085
 08. 3-STATE EXPENDABLE 8-FUNCTION 8-INPUT GATE 4048
 09. DUAL J-K POSITIVE EDGE TRIGGERED FLIP-FLOP 7470
 10. DUAL JK M/S FLIP-FLOP 4027
 11. DUAL J-K F-F WITH CLEAR 74C73
 12. 4-BIT BINARY FULLADDER 74C83
 13. QUAD 2-INPUT EX-OR GATE 4070
 14. 4-BIT DECADE COUNTER 74C90
 15. DIVIDE-BY TWELVE COUNTER 74LS92
 16. 4-BIT BINARY COUNTER 74C93
 17. 4-BIT RIGHT-SHIFT/LEFT-SHIFT REGISTER 74C95
 18. TRI-STATE QUAD BUFFERS 74C126
 19. 8-CHANNEL DIGITAL MULTIPLEXER 74LS151
 20. 4-LINE TO 16-LINE DECODER/ DEMULTIPLEXER 74C154
 21. 8-BIT D/A CONVERTER DAC 0808
 22. 8-BIT A/D CONVERTOR ADC 0808
- * Strongly supported by detailed Operating Instructions, giving details of Object, Theory, Design procedures, Report Suggestions and Book References.
 - * Weight : 5 Kg. (Approx).
 - * Dimension : W 412 x H 150 x D 310

Digital IC Trainer (TTL) (for Verification of Truth Table of Logic Gates)

Order Code - 33512



Digital IC Trainer (TTL) has been designed for verification of the truth table of logic gates and address etc. Students can be trained about the digital ICs by using this board. The fundamentals of the digital ICs can easily be understood by performing required experiments for verification of truth table of logic gates. Quite large area of the bread board has been provided on the panel for ICs. Students can make the circuits easily on the bread board with the help of other accessories which have been provided on the panel. Practical experience on this board carries great educative value for Science and Engineering Students.

specifications:

- * OUTPUT D.C. VOLTAGE : Fixed 5V ±1%.
- * OUTPUT CURRENT : 1.5 Amp.
- * LOAD REGULATION : ±1% of the highest specified output voltage. (NO LOAD TO FULL LOAD)
- * RIPPLE AND NOISE : less than 5 mV.
- * VARIABLE CLOCK FREQUENCY : 1 Hz -100 Hz
100 Hz -10 KHz, 10 KHz - 1 MHz
- * LOGIC INPUTS : Four switches for High/Low.
- * OUTPUT INDICATORS : Two 5 mm bright Red LEDs.
- * SEVEN SEGMENT DISPLAY : "Common Anode" type Red LED.
- * BREAD BOARD : Half main strip for connections & : One full main strip each set for ICs.
- * OPERATING CONDITIONS : 0 to 40°C and 95% R.H. at 40°C.
- * LOGIC GATES PROVIDED : OR (7432), AND (7408), NOT (7404) NAND (7400), NOR (7402) & EX-OR (7486)
- * EXTRA FEATURES : Other ICs can also be used to perform required experiments with any gates/ address etc.
- * INPUT VOLTAGE : 230 V ±10% at 50 Hz A.C. Mains.
- * Strongly supported by detailed Operating Instructions, giving details of Object, Theory, Design procedures, Report Suggestions and Book References.

Bread Board Trainer

Order Code - 33513



Bread Board Trainer Board has been designed to make the students familiar about the utility of Bread Board. This Bread Board Trainer is a basic lab. equipment for assembling various prototype circuits without soldering. For experiment purpose other necessary accessories are provided on the panel. Practical experience on this board carries great educative value for Science and Engineering Students.

Specifications:

- * OUTPUT D.C. VOLTAGE : Fixed 5V ±1%.
- * OUTPUT CURRENT : 2 Amp.
- * OUTPUT D.C. VOLTAGE : Fixed 15V ±1%.
- * OUTPUT CURRENT : 500 mA.
- * LOAD REGULATION : ±1% of the highest specified output voltage. (NO LOAD TO FULL LOAD)
- * RIPPLE AND NOISE : less than 5 mV.

- * CLOCK PULSES : 1 Hz and 1 KHz by manual pulser.
- * LOGIC INPUTS : 8 switches for High/Low.
- * BREAD BOARD : 3 mains strips (Approx. 175mm long). : 5 bus mains strips (Approx. 175mm long).
- * FOR CONNECTIONS : 1/2 mains strip (Approx. 175mm long).
- * OPERATING CONDITIONS : 0 to 40°C and 95% R.H. at 40°C.
- * INPUT VOLTAGE : 230 V \pm 10% at 50 Hz A.C. Mains.
- * Weight : 3 Kg. (Approx).
- * Dimension : W 340 x H 110 x D 210

NOTE: Bulk order for above Trainer has been received against International Competitive Bidding (InCB) under World Bank Project for Technical education.

Logic Gates Circuit Trainer (Educational Training Laboratory)

Order Code - 33514



Logic Gates Circuit Trainer offers a unique entry into the world of microelectronics. The system combines simple, easy to use, ICs for various gates and flip-flops, power supply, clock input and output state with a versatile solderless bread board area. Students new to digital electronics can implement logic circuits in a matter of minutes on the bread board area. As confidence grows the student will naturally progress for using more complex logic ICs on the large bread board area. This unique approach enables the unit to be used by the absolute beginner, yet it may also be usefully employed in advanced project work. The many outstanding features of the logic trainer, combined with its ease of use and robust housing, make it the first choice for those wishing to introduce students to digital electronics for the first time.

Practical experience on this board carries great educative value for Science and Engineering Students.

Specifications:

- * OUTPUT D.C. VOLTAGE : Fixed 5V \pm 1%.
- * OUTPUT CURRENT : 1 Amp.
- * LOAD REGULATION : \pm 1% of the highest specified output voltage. (NO LOAD TO FULL LOAD)
- * LINE REGULATION (For \pm 10% change : less than 50 mV. in mains Voltage i.e. 230V)
- * RIPPLE AND NOISE : less than 5 mV.
- * CLOCK INPUT DEVICE : Clock pulse of 1 second.
- * DEBOUNCED LOGIC SWITCH (HI/LO) : Four nos. Input voltage of HI level \approx 2.25V. Input voltage of LO level \approx 0.8V.
- * 4 BITS LED OUTPUT INDICATOR : Maximum input voltage less than or equal to 5V D.C.
- * SOLDER LESS BREAD BOARD : Bread Board having one main strip, total interconnected 640 tie points for ICs and half main strip, total interconnected 320 tie points for power supply, Clock, Input and output state. Each strip having length 173mm and accepting dia 0.56mm/24SWG recommended, use only 22-26 SWG wire for interconnections.
- * BASIC LOGIC GATES & : Four AND gates, Four OR gates, Four NAND gates, Four NOR gates, Six NOT FLIP FLOP UNITS gates, Dual J-K flip-flop, J.K.

master/slave flip-flop & Dual D-type flip flop.

- * APPLICATIONS : Verification of AND, OR, NOT, NAND, NOR Gates & their truth table.

Verification of Boolean Algebra. The half-adder and full-adder design. Verification of D-type flip-flop and truth table. Verification of JK flip-flop and truth table. Verification of Dual JK Master/Slave flip-flop and truth table.

Features:

- * The unit is operative on 230V \pm 10% at 50Hz A.C. Mains.
- * Strongly supported by detailed Operating Instructions, giving details of Object, Theory, Design procedures, Report Suggestions and Book References.

Optional Accessories :

- * Jumper wire bag (4 reels, 5M/reel),Cutter/Stripper tool.

NOTE: Bulk order for above Trainer has been received against International Competitive Bidding (InCB) under World Bank Project for Technical education.

Electricity Trainer

Order Code - 33515



'Electricity Trainer' is a versatile training kit for a laboratory. It is designed such that all the basic electrical circuits can be tested with the help of this trainer kit. The experiments given with training system develop mental starting from an introduction to the circuit, basic fundamentals and complete circuits like series and parallel circuits, electromagnetic induction, coil behaviors with AC and DC circuits diode and transistor characteristics etc. This simple training kit provides a strong foundation for future studies in electrical or electronics. This takes students from the basic of ohm's law, through simple series and parallel circuit analysis and into same elementary aspects of electronics where they will build circuits using capacitors, transistor and diodes. Student can study how the resistance of a light bulb filament changes as it heats up. With this system a set of coils and cores are provided- These high quality coils and laminated iron cores provides an effective introduction to electromagnetic theory. Each coil is labeled with number of turns. These can be used in study of The Equipment is Useful for Students at level in engineering / technical institutes (EC & Telecom) Technical training centers in communication organizations, R&D personal and practicing engineering in research labs and industry.

Object:

Experiments that can be performed

01. To study the Resistances individually, as well as in series and in parallel connections.
02. To study the ohm's law mathematical relation ship between three variables voltage (V), current (I) and resistance (R).

03. To study the voltage and current flowing into the circuit.
04. To study the behavior of current when light bulbs are connected in series/parallel circuit.
05. To study the Kirchoff's Law for electrical circuits
06. To study the R-C circuit and find out the behavior of capacitor in a R-C network and study the phase shift due to capacitor. .
07. To study the L-C circuit and its oscillations.
08. To study the characteristics of a semiconductor diode.
09. To study the characteristics of a transistor.
10. To understand the Faraday's Law of electro magnetic induction.
11. To study the behavior of current when inductance is introduced in the circuit.
12. To study the Lenz's Law and effect of eddy current.
13. To study the relay and construct a switching circuit by using relay
14. To study the Oersted experiment.
15. To study the phenomenon of mutual induction.
16. To construct and study the step down transformer with the help of given coils and cores.
17. To construct and study the step up transformer.
18. To study the effects of moving I core on a step up transformer.
19. To convert a galvanometer into voltmeter.
20. To convert a galvanometer into ammeter.

Specification & Features:

DC power Supply	: 5V. 200 mA
DC power Supply	: 12V. 200 mA
AC power Supply	: 6V, 1A
Relay	: 12V
Galvanometer	: 30 -0 -30 .
Galvanometer	
Resistance	: 80 Ohm
Light Bulbs (3 Nos.)	: 6V
Potentiometers (3 Nos.)	: 25 Ohm. 1 W 10 K Ohm. 1 W
Switch	: 1 Pole, 2 Way Toggle Type
Core Types	: E, I, U
Main Supply	: 230V AC 50Hz
Dimension	: W 340 x H 110 x D 210

Accessories Component Box :-

01. Resistors	-	40
02. Capacitors	-	04
03. Transistors	-	02
04. Diodes	-	02
05. Mains lead	-	01
06. Magnetic Compass	-	01
07. Bar Magnet	-	01
08. Set of Coils	-	06
09. E, I, U Core	-	
10. Multimeter	-	01
11. Screw Driver	-	01
12. Connection Patch Cords	-	25

Other Apparatus Required:

- * Cathode Ray Oscilloscope 20MHz.

Electricity Lab

Order Code - 33516



“Electricity Lab” is a versatile training kit for a laboratory. It is designed such that all the basic electrical circuits can be tested with the help of this trainer kit. The experiments given with training system develop mental starting from an introduction to the circuit, basic fundamentals and experiments on Ohm's Law, Magnetism, Relay, Power, Lenz's Law, Motors, Diode, Kirchoff's Law, R, L, C and many more. This simple training lab provides a strong foundation for future studies in electrical or electronics. This takes students from the basic of ohm's law, through simple series and parallel circuit analysis and into same elementary aspects of electronics where they will build circuits using capacitors and diodes. With this system a set of coils and cores are provided. These high quality coils (Labeled with number of turns) and laminated iron cores provides an effective introduction to electromagnetic theory.

Specifications:

01. Meters: 5 Nos.
 - 1.1. AC Voltmeter : 15V
 - 1.2. DC Voltmeter : 15V
 - 1.3. Galvanometer : $\pm 250\mu\text{A}$
 - 1.4. DC Ampere Meter : 0.6Amp
 - 1.5. DC Ampere Meter : 5A
02. Power Supply:
 - 2.1. Power Supplies : 3, 6, 12Vat 3.5A
 - 2.2. Power SupplyAC : 30Vat1A
 - 2.3. Power SupplyDC : 5Vat100mA
03. Switch SPDT
04. Switch DPDT
05. Push switch
06. Logic Switches Two No. Push type
07. Relay 12VDCOne change over
08. Buzzer/Electric Bell
09. Transformer Input 6-0-6V and Output 6-0-6V
10. Bulb6VThree Nos.
11. Resistance 1E2/1W, 5E/5W, 50E/5W,100E/5W, 220E/2W, 470E/2W, 1K/1W, 100K/1W
12. Capacitance 1000MFD/25VTwo Nos.
13. Diode IN4007Two Nos.
14. LED5mm
15. Thermocouple
16. Potentiometer 10K
17. Breadboard 840Tie Points
18. Fuse Holder open type
19. Electromagnetic Induction&Transformer
20. Main Supply 230VAC, 50 Hz

Accessories:

01. Beaker 100ml - 1 No.
02. Patch Cords/ Connecting Leads - 12No s.
03. Rods/ Strips for - 1 No. each Copper, Tin, Al, Zinc, Glass Brass, Carbon, Iron, Acrylic, Lead, Stainless Steel
04. Magnets - 3Nos.(Bar Type-2, Horseshoe (U) type-1)
05. Coils - 1 No. 100 and 200 Turns
06. Crocodile Clips - 1 No. red and black
07. Battery/ Cell with holder - 2 Nos. 1.5 V
08. Glass Fuses - 10 Nos. 0.5A
09. Compass - 1 No.
10. Measuring Scale - 1No.
11. Insulated Disc - 1 No.
12. Motor Assembly - 1 No. including Armature, Rotor, Brush, Motor Support, Iron Fillings
13. Helix Assembly - 1 No.

14. Meter Demonstration - 1 No.
15. Core - 1 Set of U&I with Bolt
16. Aluminium Ring - 1 No.
17. Stand - 1 No. for motor action demonstration
18. IC - AND (IC7408), OR (Ic7432), NOT (7404) And EX-OR Gate (IC7486)
19. Multimeter - 1 No.
20. Soft Iron Piece - 1No.

Experiment Coverage:

To Study/ Experiment the following:

01. Electricity by Chemical Action
02. Electricity by Heat
03. Electricity by Magnets
04. Conductors and Insulators
05. Resistor Colour Code
06. Resistors in series combination
07. Resistors in Parallel combination
08. Resistors in series and Parallel combination
09. Ohm's Law
10. Applying Ohm's Law
11. Kirchoff's Current Law or Junction Rule
12. Kirchoff's Voltage Law or Loop Rule
13. Linear & Non Linear Resistance
14. Measurement of Power
15. AC & DC Power
16. Fuses and Circuit Breakers
17. Heating Effect & the Fuse
18. Load in Series and Parallel Circuits
19. Cells Connections
20. Voltage in series & parallel Circuits
21. Current in series and parallel Circuits
22. Meter Movement
23. Meters in a Circuit
24. Charging and Discharging of Capacitors
25. Study of Diode
26. Full Wave Rectifier (optional)
27. The Contactor
28. Study of Relay
29. The Electric Bell
30. Magnets and Magnetism
31. Magnetic Field
32. Magnetic Properties
33. Magnetic Strength
34. Magnetic field around a conductor
35. Magnetic poles around a helix
36. Electromagnetic Strength
37. Electromagnetic Effect
38. Lenz's Law
39. Self Inductance
40. Mutual Induction
41. Transformer Action
42. Transformer Ratio of Voltages
43. Transformer Phasing
44. Faraday's Law of Electromagnet Induction
45. Motor Action
46. The Electric Motor Generator
47. Generation of DC
48. Generation of AC
49. Permanent Magnet DC Motor
50. DC Series Motor
51. DC Shunt Motor
52. AC Universal Motor
53. AND Logic Gate with truth table
54. OR Logic Gate with truth table
55. NOT Logic Gate with truth table
56. X-OR Logic Gate with truth table
57. Convert a Galvanometer into voltmeter

58. Convert a Galvanometer into Ammeter

Power Electronics Lab

Order Code - 33517



Power Electronics Lab is used to perform power electronics circuit experiments. It is very useful in power electronics laboratories for performing power experiments in colleges and universities. It is very for student to know about the characteristics of power electronics devices and the applications of power devices. The applications or power devices are in alarm circuit, lamp flasher, rectifiers, choppers, invertors. It is also used for commutation circuits.

The Equipment is Useful for Students at level in engineering / technical institutes (EC & Telecom) Technical training centers in communication organizations, R&D personal and practicing engineering in research labs and industry.

Technical Specifications:

DC Power Supply on Board	: ± 5V at 100mA
	: ± 12V at 150mA
	: ± 15V at 50mA
	: ± 35V at 50mA
AC Power Supply on Board	: 18V - 0V - 18V at 50mA
	: 15V - 0V - 15V at 50mA
Triggering Circuit on Board	: 5 gate signal output
Frequency range	: 40Hz to 900Hz Variable
Amplitude	: 12V
	PWM control of G1,G2,G3 and G4 Duty cycle control of "Gate" Signal is 0 to 100%
Single Phase Rectifier:	Firing angle control 0°-180° variables
Firing Circuit on Board	: Four gate signal output with isolation
SCR Assembly	: 4 SCRs 2P4M, 600V,2A
Power Devices	: IGBT-G4BC20S, MOSFET-IRF540, UJT-2N2646, DIAC-DB3, TRIAC-BT136, PUT-2N6027

Circuit Components On Board :

Capacitor 0.01uF, 0.047uF, 0.1uF, 0.33uF, 1uF/63V(4Nos.) 2.2uF/50V Diode 1N4007 (8Nos.) Zener Diode 9V (1Nos.) Inductors 10mH, (1Nos.), 68mH (2Nos.) Load Resistance 120E, 270E, 1K, 2K2, each 5W Resistance on Board (½ W) 22E/5W, 100E/2W, 220E/2W Resistance on Board(1/4W) 10K (3Nos.), 22K,33K,47K, Potentio Meter 4K7(2Mos.), 1M(1Nos.) Pulse Transformer on Board : 2 Nos. PT4502, 1:1 and one is PT4503 1:1:1 Toggle Switch : SPST (1Nos.) Power Requirements : 220V ±10%, 50Hz

Experiments On Board Using Breadboard:

01. To study the characteristics of SCR and plot its V-I Characteristics.
02. To study the Gate control characteristics of SCR and It's graph.
03. To study the characteristics of UGT and calculate

interbase resistance and intrinsic standoff ratio.

04. To study the characteristics of MOSFET.
05. To study the characteristics of IGBT.
06. To study the characteristics of DIAC and plot its V-I Characteristics curve.
07. To study the V-I characteristics of TRIAC.
08. To study the characteristics of PUT.
09. To study of class B commutation circuit.
10. To study of class C commutation circuit.
11. To study of class D commutation circuit.
12. To study of class F commutation circuit.
13. To study the Resistor Triggering circuit.
14. To study the Resistor-Capacitor Triggering Circuit (Half wave).
15. To study the Resistor-Capacitor Triggering Circuit (Full wave).
16. To study the triggering of SCR using UJT.
17. To study the Triggering of SCR using 555 IC.
18. To study the Triggering of SCR using Op-Amp 741 IC.
19. To study of the ramp and pedestal triggering using anti-parallel SCR in AC load.
20. To study of the UJT relaxation oscillator.
21. To study of the voltage commutated chopper.
22. To study of the Bedford inverter.
23. To study of the single phase PWM inverter using MOSFET.
24. To study of the single phase PWM inverter using IGBT.
25. To study the half-wave controlled rectifier with resistive load.
26. To study the half wave controlled rectifier with RL load.
27. To study the full-wave controlled rectifier (mid-point configuration) with resistive load.
28. To study the full-wave controlled rectifier (mid point configuration) with RL load.
29. To study the fully controlled bridge rectifier with resistive load.
30. To study the fully controlled bridge rectifier with RL load

Electrical & Electronic System Trainer Master Unit

Order Code - 33519



Features:

01. Aesthetically designed injection moulded electronic desk (Master unit) carrying useful experiment resources Variable Power supplies / Status / Pulsar / Function Generator ,DPMs etc. while the central slot will carry replaceable experiment panel secured in an ABS molded plastic sturdy enclosure, and has colorful screw less overlay showing circuit & its connect ion tag numbers for easy connectivity.
02. Connection through Sturdy 4mm Banana Sockets & Patch Cords.
03. Hands on learning by constructing circuits using built in power bread board panel as well as optionally using Discrete component panel.
04. Set of Users Guide provided with each Unit.
05. Order 10 Master Units & multiples of 10 or more

panels set.

Specifications:

Built in Power Supply

DC Supply : 5V / 1A. & ± 12V, 500mA.0 to 15V DC (Variable), 100 mA (Isolated) 0 to 30V DC (Variable), 100 mA (Isolated) High Volt DC - 15V to 220 V, 100mA.

AC Supply : 12-0-12V AC, 150 mA. Short circuit protected

Built in Function Generator

Output Waveform : Sine, Triangle & TTL O/Ps

Output Frequency : 1 Hz to 1MHz in 6 ranges, with amplitude & frequency control pots. O/P Voltage 20V p-p max. (Sin / TRG)

Modulation I/P : A M : - I / P voltage + 5 V (100% modulation) O/P - For 0V (min), + 5V (max.) - 5V (Phase reversal of O/P) FM: I/P voltage ± 400mV (+ 50% modulation)

- * Clock Generator: 10 MHz TTL clock.
- * Data Switches (10no.) & bi-colour LED status indicators 10X2 nos, for High/Low indication.
- * Pulsar switches (2 nos.) with four debounced outputs-2no.
- * BNC to 2 channel banana adapter-2no.
- * Logic probe to detect High/Low level pulses upto 1MHz, with bi-colour LEDs to indicate status.
- * 2 / 4 digit 7 segment display with BCD to 7 segment decoder.
- * Onboard DPMs provided with mode/range selection.
 - (A) DC volt : 2V/200V- 1no.
 - (B) DC current : 2mA/200mA - 1no.
 - (C) DC Volts/Current : 20V/200mA - 1no.
- * Onboard moving iron meters provided for
 - (A) AC Current: 1 AMP - 1No.
 - (B) AC Voltage: 15V - 1No.
- * Onboard speaker - 8 Ohms, 0.5 Watt (1no.)
- * Onboard POTS : 1K--1no. 1M--1no.

Mechanical Dimensions

(A) Master Unit: 400(W) x 125(H) x 270mm (D)
Net weight: 8 Kg. Gross Weight: 10 Kg.

(B) Panel: 215(W) x 165(H) x 40mm(D)
Net weight: 700 gm approx.

- * Operating Voltage - 220/240Vac switch settable +/- 10%, 50Hz/72VA.

Digital Overlay Learning System

Order Code - 33528



Order code - 33528 Electronics could be taught straight from a book if students were able to visualise the function of an experimental circuit. Unfortunately this is rarely the case and until now it has been necessary to laboriously assemble every experiment to be examined.

The assembly of each circuit has no didactic value

whatsoever other than to provide the student with a circuit on which to perform the experiment. Now, this can be dramatically improved with the 33528 Digital Electronics Overlay Learning System.

Features:

The 33528 Digital overlay learning system allows the student to assemble even the most involved circuit in less than five minutes, thus leaving enough time for fruitful experimentation.

The 33528 system features wiring templates which fit over a breadboard and guide students to an immediate and rational experimental layout whilst the experiment book relates to the traditional circuit diagram.

The 33528 Digital overlay learning system is ideal for use with omega products of 33506 Digital Lab Station , 33504 Digital Trainer, 33507 Power Project Board, 33501 Digital Lab , and Analogue and Digital Lab, system's.

No add-ons are required. All the necessary equipment including a standardised set of components is included. The thoroughly researched courseware was designed by educators with over 20 years practical teaching experience, with the aim to enforce theory and not confuse students. The professionally produced manuals are referenced to the most widely used theory books, and the schematic diagrams, component listings, and experiment procedure are clearly listed. Each experiment was tested for typical student reaction prior to final editing.

No prerequisites are demanded other than basic arithmetic. The emphasis is on an instrumental understanding rather than a mathematical one. The continuous hands-on exposure ensures the transfer of marketable technological skills in the minimum amount of time.

Objects:

01. Basic logic functions
02. Boolean algebra and simplification of logic equations
03. De Morgan's theorem
04. TTL NAND/NOR gates definitions and operation
05. NAND/NOR gates definitions and operation
06. The exclusive-OR and its applications
07. The full-adder and full-subtractor
08. The bistable or flip-flop (FF)
09. Binary counters and the binary number system
10. Divide-by-n counters and decade counters
11. Shift registers and ring counters
12. Pulse forming and shaping: the Schmitt trigger
13. Integrated circuit timers: the 74122, 74121, and 555
14. Decoding and encoding
15. Random access memories (RAM): scratch pad memories
16. The operational amplifier
17. Digital to analogue (D/A) and analogue to digital (A/D) conversion
18. Complementary symmetry MOS (CMOS): principles and characteristics
19. Complementary symmetry MOS (CMOS): TTL interface

Package Contents

01. Wiring templates (62 pieces)
02. Experiment manual 1set
03. Component pack 1 set with templates
04. Breadboard 1680 Tie points
05. Dimensions 170 x 127 x 50mm
06. Weight 1.4Kg.

Components Provided

07. (Hard Waver) :
Templates, Dip Switch 1P 4W/ 2, Dip Switch 1P 8W/1, Switch SPDT /4, Carbon Pot 16mm 470E/2 with knob,
08. (Resistor) :
Resistor \pm 5% 0.25W, 330E/10,470E/1, 680E/7,820E/2, 1K/2, 1K2/10, 1K5/5,2K2/1, 4K7/2, 5K6/2, 10K/1, 15K/1, 22K/1, 27K/2, 47K/1, 100K/1
09. (Capacitors) :
Disc capacitor 4700pF/1, 0.01uF/2, 0.033uF/1, 0.1uF/1, 0.22uF/1, Electrolytic capacitor 1uF/63V/1, 4.7uF/63V/1, 100uF/25V/1,
10. (Semi conductor) :
LED 5mm/10, Transistor BC107/2, Seven segment Display LT542/1, IC4001/1, 4007/1, 4050/1, 7400/2, 7402/1, 7403/1,7404/2, 7405/2, 7406/1, 7408/1, 7410/2, 7414/1, 7420/2, 7432/1, 7442/1, 7447/1, 7451/1,7472/4, 7476/3, 7483/1, 7486/2, 7489/1, 7490/2, 7496/1, 74121/1, 74122/1, LM741/2,NE555/1, Diode IN4007/1, ZD 4V7/1

List Of Accessories:

Wire 24/25 SWG. 1Meter each 5 Colour

Analog Overlay Learning System

Order Code - 33529



33529 Electronics could be taught straight from a book if students were able to visualise the function of an experimental circuit. Unfortunately this is rarely the case and until now it has been necessary to laboriously assemble every experiment to be examined.

The assembly of each circuit has no didactic value whatsoever other than to provide the student with a circuit on which to perform the experiment. Now, this can be dramatically improved with the 33529 Analog Overlay Learning System.

Features:

The 33529 Analog Overlay Learning System allows the student to assemble even the most involved circuit in less than five minutes, thus leaving enough time for fruitful experimentation.

The 33529 Analog Overlay Learning System features wiring templates which fit over a breadboard and guide students to an immediate and rational experimental layout whilst the experiment book relates to the traditional circuit diagram.

No add-ons are required. All the necessary equipment including a standardised set of components is included. The thoroughly researched courseware was designed

by educators with over 20 years practical teaching experience, with the aim to enforce theory and not confuse students. The professionally produced manuals are referenced to the most widely used theory books, and the schematic diagrams, component listings, and experiment procedure are clearly listed. Each experiment was tested for typical student reaction prior to final editing.

No prerequisites are demanded other than basic arithmetic. The emphasis is on an instrumental understanding rather than a mathematical one. The continuous hands-on exposure ensures the transfer of marketable technological skills in the minimum amount of time.

Objects:

01. Semiconductor Silicon Diodes in DC Circuits
02. Light Emitting Diodes in DC Circuits
03. Silicon Diodes in AC Circuits: Half Wave Rectification
04. Silicon Diodes in AC Circuits : Full Wave Rectification
05. The Use of a Diode Bridge in DC Circuits
06. The Use of a Diode Bridge in AC Circuits
07. Filtering and Regulation of a Pulsating DC Voltage
08. An Experimental Power Supply using a "PI" Filter
09. Voltage Multiplying using diodes & Capacitors : Voltage Doubling
10. DC Current Gain of a Common Emitter Transistor Configuration
11. The Common Emitter as an AC Amplifying Stage
12. Cascaded Stages of Amplification
13. Class A Single-Ended Loudspeaker Driven Audio Amplifier
14. The Class A Push-Pull Audio Amplifier
15. Complementary-Symmetrical Push-Pull Output Circuits
16. The Field Effect Transistor : The Common-Source Amplifier
17. Oscillator Circuits: The Zero-Phase Shift Oscillator
18. Oscillator Circuits : The Phase-Shift Oscillator
19. Oscillator Circuits : The Armstrong Oscillator
20. Oscillator Circuits : The Hartley Oscillator
21. Oscillator Circuits : The Colpitts Oscillator
22. Digital Integrated Circuits : The AND Gates
23. Digital Integrated Circuits : The OR Gate
24. Digital Integrated Circuits : The AND-OR Function
25. Digital Integrated Circuits : The Inverting Gate
26. Digital Integrated Circuits : The NAND Gate
27. Digital Integrated Circuits : The NOR Gate
28. Digital Integrated Circuits : The Full Adder

Package Contents

01. Wiring templates (28 pieces)
 02. Experiment manual 1 set
 03. Component pack 1 set with templates
 04. Breadboard 1680 Tie points.
 05. Dimensions 170 x 127 x 50mm
 06. Weight 1.4Kg.
- RESISTORS 1/2W : 100E/1 120E/1, 270E/5, 470/1, 680/1, 1K/2, 1K5/2, 1K8/1, 2K7/23K3/1, 3K9/1, 4K7/3, 5K6/1, 8K2/1, 10K/3, 22K/1, 27K1, 33K/1, 39K/1, 47K/1, 68K/1270K/1, 1M/1,

- RESISTORS HIGHER WATT : 10E, 1W/1, 4E7, 5W/1, .
- POLYESTER CAPACITORS : 0.01uF/3, 0.015uF/2, 0.022uF/2, 0.047uF/2, 0.1uF/1, 0.22uF/2
- ELECTROLYTIC CAPACITORS : 22uF/25V/2, 100uF/25V/3
- POENTIOMETERS : 1K/1, 4K7/2, 10K/1
- SWITCHES : SPDT/3.
- DIODES AND LEDs : IN4007/4, 5mm LED (Red)/5
- TRANSISTOR : CL-100/1, CK-100/1, BC546/2, 2N-2222/2, BFW10/1
- TRANSFORMERS : OUT-PUT/1, IN-PUT/1, MAIN TX 6V3-06V3/1
- INTEGRATED CIRCUITS : 7400/1, 7404/1, 7411/1, 7432/1
- SPEAKER : 8E, 0.25W/1
- MULTIMETER : 03

List of Accessories:

01. Mains cord
02. Red & Black patch cords (2mm two 1MM) 10 each,
03. Red & Black patch cord (1mm to 1mm) 10 each.
04. Wire 24/25 SWG. 1 Meter each 5 Colour

Instruction Manual:

Strongly supported by detailed operating instructions.

Circuit Development Platform

Order Code - 33530



33530 Circuits Development Platform is designed to do experimentation with Analog & Digital Circuits in the laboratory. It is a self contained trainer including DC Power supplies, Sine/Square/TTL Generator etc on as a single unit. It is very useful in project work and testing. A number of ready to use experiment circuit boards are optionally available.

Bread Board

Unique solder-less large size, spring loaded breadboard consisting of two Terminal Strips with 640 tie points and 2 Distribution Strips with 100 tie points each, totaling to 840 tie points. (Size: 63mm x 170mm)

DC Power Supply

Variable DC power: Two, Positive output voltage: 0 to 30V, Maximum output current: 100 mA, Fixed power supply: Positive output voltage: ± 5V, 9V, 12V, 15V, 18V, 24V, ± 5%, Maximum output current: 100mA

Function

GENERATOR : Sine / Square / Traingular / Pulse waveform frequency 1 Hz to 110 Khz in 5 Steps. Variable in between steps. Sine / Square / Traingular waveform output 50mV ~ 10Vpp variable

Digital Voltmeter

3 1/2 digits LED display, Four ranges: 0 - 2V full scale, 0 - 20V full scale, 0 - 200V full scale, 0 - 1000V full scale

Digital Current Meter

3 1/2 digits LED display Seven ranges: 0 - 20uA full scale, 0 - 200uA full scale, 0 - 2mA full scale, 0 - 20mA full scale, 0 - 200mA full scale, 0 - 2Amp full scale, 0-5Amp full scale

Pulser Switch

Input for positive or negative pulse triggering from external source.

Data Switch

Four independent logic level inputs to select High / Low TTL levels.

Logic Indicators

Four independent logic level indicators for High / Low status indication of digital outputs

Potentiometers

Four Potentiometers (1K, 10K, 100K, & 1Meg) with Sockets.

Computer

INTERFACE : On Board Parallel Port DB-9 & DB-25

On Board Switch

Switch Double pole double through

BNC to Banana

ADAPTER : BNC to 4mm & 2mm banana adapter

Weight : 4 Kg. (Approx)

Dimension : W 412 x H 150 x D 310

- * Mains ON/OFF switch, Fuse and Jewel light.
- * The unit is operative on 230V ±10% at 50Hz AC Mains.
- * Good Quality, reliable terminal/sockets are provided at appropriate places on panel..
- * Strongly supported by detailed Operating Instructions.

List of Accessories:

01. Patch Cord Length 50Cm 4mm to 1mm Red-----04
02. Patch Cord Length 50Cm 4mm to 1mm Black----04
03. Patch Cord Length 50Cm 2mm to 1mm Red-----04
04. Patch Cord Length 50Cm 2mm to 1mm Black----04
05. Hookup Wire Sz. 1/25 5 Color Length 2mr. Each

BreadBoard

Order Code - 33531-33533



You just plug-in vertically your components in the position you want without soldering. The projectboard will accept up, clock-clips, the smaller DIP's. Each unit will accept transistors, diodes, LEDs, resistors, capacitors, pots and virtually all types of components. The units are designed to use # 22-30 solid hookup wire for interconnection will plug-in ease. It could be combined with a series features a unique interlocking desired, without tools to meet changing requirements and components are reusable.

* External Body is made of ABS.

* The internal interconnected clips are Nickel-Plated.

Features:

Specifications	33531	33532	33533
Length (mm)	172	165	172
Width(mm)	65	54	65
Height (mm)	10	8.5	10
TIE Points	840	830	840
5 Inter- connected Clip	128	126	128
25 Inter- connected Clip	8	8	8
IC Capacity 14 Pins	9	9	9

Computer Assisted Circuit Trainer

Order Code - 33534



Features:

01. Aesthetically designed injection moulded electronic desk (Master unit) with common experiment resources like Power supplies, Function Generator, switches, indicators, DPM etc. while the slot will carry replaceable expt panels.
02. 4 mm sockets arranged on a grid of 19 X 19mm to receive plug in components useful for students in non electronic streams of engineering.
03. Computer assisted Training through use of Lab view based executables, optionally supported by variety of virtual instrumentation like toggle switches, leds, DMM, CRO etc. interface through USB IO module.
04. Emphasis on troubleshooting skill through fault switches, locate hidden the experiment panels.
05. Following Replaceable panels connect to Top Board resources / computer / I/Fon master unit through 64 pin Euro connector.
06. Useful for Post Graduate projects and research purpose
07. Set of Users Guide provided with each unit.

Modular expt. panels offered (At least select one or more)

1) Digital Logic panel

[Provided with 227 banana sockets]

01. Consist of DIP sockets : 14 pin (7 nos), 16 pin (5 nos), 24nos. of buffered leds using 3nos. LS245 as LED driver, 4 TTL clock outputs 1, 10, 100Hz, 1KHz.
02. Generic ICs used : 7400 (NAND), 7408 (AND), 7432 (OP), 7495 (SHIFT REG), 7404 (NOT), 7486 (EX-OR), 7476 X 2Nos. (J-KFF), 7490 (DECADE COUNTER), 74138 (DECODER), 74148 (ENCODER), CD4051 (MUX/DEMUX), 1X3 extender (2nos).
03. Experiment covered
 - i) Basic logic gates experiments-OR, AND INVERTER, NOR NAND, EX-OR, EX-NOR
 - II) Boolean Algebra theorems-25nos., Karnaugh Map
 - iii) Combinational circuit adder, subtractor, code converter Like Gray code, 7 seg BCD, Hex

Excess-3, Parity checker, Encoder/ Decoder Multiplexer / Demultiplexer
 iv) Sequential Logic like Flip-Flops- R-S, J-K, T,D. Counters- Async/Sync, decade, ring/twisted, Divide by N (modulo N)
 v) Multivibrator circuit (Mono/Bistable/Astable).
 vi) Applications- Traffic signal control, Staircase Lamp etc.

2) Plug-in components panel

[Provided with 205 banana sockets]

01. Consists of 19 grid of 4 mm sockets, All plug in discrete components are housed in Acrylic transparent top module of size 50.5mm X 32.5mm with 4 (8 optional) plugs to facilitate easy viewing & handling w/o fear of damage. Useful for students w/o electronic background.
02. Plug in components (TTM) diode (4nos), resistor (8nos), Potentiometers (2nos), led (2nos), transistor (4nos), Relay (1no) etc. Qty = 25nos. Assorted

3) Bread board panel

[Connectivity through 64 X 2 tie points]

01. Consists of 3360 tie points bread board and 64 X 2 connectivity tie points offering top board resources like Function Generator, status switches, logics indicators, power supply, 8;/O lines, pulser outputs, 4 TTL clock output 1,10,100Hz. 1khz etc. for easy connectivity using 22/24 SWG single wires, 28 pin ZIF Socket, Input data switches - 8 Nos, pulser Switch-1No., RC Circuits-4nos., On board pot 100-K -1No., Bicolour buffered LED status indicators 8 X 2 for high low indication BS5 to Bread Board converters - 8Nos., BNC to banana converter- 2Nos.

4) Digital panel II

[Provided with 269 banana sockets]

01. Consists of DIP sockets : 14 pin (7nos), 16 pin (5nos), 28pin ZIF sockets (1no.) 4TTL clock outputs-1, 10, 100Hz, 1KHZ Bi-colour buffered LED status indication 8X2 for high/low indication, Input data Switches 8 nos., NO_NC pulser switch - 1no./ On board pot 100K-1no., RC ckts for Mono stable M.V. RC ckts for ADV.BNC to banana convertor-2nos.
02. Generic ICs Used : TTL, COMS ICs like 74280 (Parity Generator), 7407 (buffer), 74CHT14 (Schmitt Inverter), CD4011(NAND), 7485 (Comparator), 74191 (Counter), 74123 (Multi-vibrator), CD4013 (D/F/F), CD4052(MUX/DEMUX), CD4001(NOR), Cd4093 (Schmitt NAND), CD4007 (CMOS Inverter).
03. Experiments Covered : Study of TTL, CMOS characteristics, schmitt gate circuit, Circuits using NAND gate, Multiplexer circuits, Opencollector gate circuits, Parity generating circuits High speed monostable circuits, Comparator circuits, Counter circuits, CMOS device characteristics, 12bit ADC DAC optional using ZIF sockets.

5) Analog computer

[Provided with 128 banana sockets]

01. Function blocks: Analog multipliers (3nos), op-amp inverting (2nos), Op-amp Basic (2nos), op-amp full (2nos), bread board for general purpose

circuits Digital to analog converters (2nos.), diodes, transistors trimmers, voltage regulators
 02. Experiments covered: Study the characteristics of negative feedback amplifiers and design of instrumentation amplifier, Study the characteristics of regenerative feedback, Study the characteristics of integrators and differentiator circuit, Design of Analog Filters Design of a self-tuned filter, Design uncton generator and convert it to voltage-Controlled Oscillator / FM generator Design of a phase Lock loop (PLL), automatic Gain control (AGC) automatic volume Control (AVC), DC_DC converter, Design low dropout (LDO) regulator, To study the parameters of LDO integrated circuit, To study the parameters of DC-DC convertor sing Stage Amplifier, Design of a Digitally programmable square and Triangular wave generator/oscillator.

Amplitude Modulation and Demodulation

Order Code - 40501



Experimental Training Board has been designed specifically for the study of Amplitude Modulation and Demodulation. This training board is based on latest solid state circuits for generating modulating signal, Amplitude Modulation and Demodulation. Practical experience on this board carries great educative value for Science and Engineering Students.

Object:

To study the process of Amplitude Modulation & Demodulation

Features:

The board consists of the following built-in parts :

01. +9V D.C. At 100mA, IC Regulated Power Supply internally connected
02. Carrier generator circuit which generates carrier wave
03. Modulating circuit based on two transistors
04. Demodulating circuit
05. Adequate no. of other electronic components
06. Mains ON/OFF switch, fuse and Neon Jewel light
- * The unit is operative on 230V $\pm 10\%$ at 50Hz A.C. Mains
- * Adequate no. of patch cords stackable from rear both ends 2mm spring loaded plug length $\frac{1}{2}$ metre
- * Good Quality, reliable terminal/sockets are provided at appropriate places on panel for connections & observation of waveforms
- * Strongly supported by detailed Operating Instructions, giving details of Object, Theory, Design procedures, Report Suggestions and Book References

Experiments:

01. To observe the carrier waveforms on C.R.O
02. To modulate carrier with audio signal and to observe waveforms on C.R.O
03. To measure percentage modulation of the amplitude modulated waveform
04. To demodulate amplitude modulated waveform and observe on C.R.O

Other Apparatus Required:

- * Decade Audio Frequency Generator Order Code - 16902
- * Cathode Ray Oscilloscope 20MHz

Frequency Modulation & Demodulation

Order Code - 40502



Experimental Training Board has been designed specifically for the study of Frequency Modulation and Demodulation. Practical experience on this board carries great

educative value for Science and Engineering Students.

Object:

01. To observe the effect of D.C. voltage on frequency of carrier waveform
02. To frequency modulate the carrier with Audio signal, observe F.M. waveform on C.R.O., and measure its modulation index
03. To demodulate the F.M. signal and observe the output on C.R.O.
04. To plot the characteristics curve of the slope detector demodulating circuit

Features:

The board consists of the following built in parts:

01. $\pm 12V$ D.C. at 100 mA, IC Regulated Power Supply
02. Carrier generator circuit which generates the carrier signal
03. Audio frequency modulating signal
04. Variable D.C. is provided to see the frequency deviation in carrier frequency
05. Frequency Modulation circuit with buffer stage at the output
06. Demodulating circuit
07. Adequate no. of other electronic components
08. Mains ON/OFF switch, Fuse and Jewel light
- * The unit is operative on 230V $\pm 10\%$ at 50Hz A.C. Mains
- * Adequate no. of patch cords stackable from rear both ends 4mm spring loaded plug length $\frac{1}{2}$ metre
- * Good Quality, reliable terminal/sockets are provided at appropriate places on panel for connections & observation of waveforms
- * Strongly supported by detailed Operating Instructions, giving details of Object, Theory, Design procedures, Report Suggestions and Book References

Other Apparatus Required:

- * Decade Audio Frequency Generator Order Code - 16903
- * Digital Frequency Counter, 6 digit Order Code - 16904
- * Cathode Ray Oscilloscope 20MHz

Pulse Amplitude Modulation and Demodulation (PAM) Trainer

Order Code - 40503



Experimental Training Board has been designed specifically for the study of Pulse Amplitude Modulation & Demodulation. Using this training board one can know the specialized techniques of Pulse Amplitude Modulation and Demodulation.

Practical experience on this board carries great educative value for Science and Engineering Students.

Object:

01. To demonstrate sampling of a sine wave audio signal thereby converting it into Pulse Amplitude Modulated Signal (PAM).
02. To demonstrate demodulation of PAM signal thereby recovering the sine wave audio signal.

03. To demonstrate the effect of sampling-rate on the distortion in recovered sine wave audio signal.

Features:

The board consists of the following built-in parts:

01. $\pm 9V$ D.C. at 100mA, IC regulated Power Supply internally connected
 02. Variable frequency sampling pulse generator
 03. Sine wave audio frequency modulating signal generator
 04. PAM Modulator circuit based on an operational amplifier
 05. PAM Demodulator circuit based on a point contact diode and an operational amplifier
 06. Adequate no. of other electronic components
 07. Mains ON/OFF switch, Fuse and Jewel light
- * The unit is operative on 230V $\pm 10\%$ at 50Hz A.C. Mains
 - * Adequate no. of patch cords stackable from rear both ends 2mm spring loaded plug length $\frac{1}{2}$ metre
 - * Good Quality, reliable terminal/sockets are provided at appropriate places on panel for connections/observation of waveforms
 - * Strongly supported by detailed Operating Instructions, giving details of Object, Theory, Design procedures, Report Suggestions and Book References

Other Apparatus Required:

- * Cathode Ray Oscilloscope 20MHz

Pulse Width Modulation & Demodulation (PWM) Trainer

Order Code - 40504



Experimental Training Board has been designed to study on the modern techniques of Pulse Width Modulation / Demodulation. Using this training board one can know the specialized techniques of Pulse Width Modulation and Demodulation.

Practical experience on this board carries great educative value for Science and Engineering Students.

Object:

01. To modulate a pulse carrier with sinusoidal signal to obtain a Pulse Width Modulated signal
02. To demodulate the Pulse Width Modulated signal to obtain the modulating signal

Features:

The board consists of the following built-in parts:

01. $\pm 6V$ D.C. at 100mA, IC regulated Power Supply internally connected
 02. Pulse Train (Carrier) Generator based on timer IC
 03. 50 Hz A.C. sinusoidal modulating signal obtained from stepped down transformer
 04. Pulse Width Modulator based on timer
 05. Pulse Width Demodulator based on operational amplifier
 06. Adequate no. of other electronic components
 07. Mains ON/OFF switch, Fuse and Jewel light
- * The unit is operative on 230V $\pm 10\%$ at 50Hz A.C.

Mains

- * Adequate no. of patch cords stackable from rear both ends 2mm spring loaded plug length $\frac{1}{2}$ metre
- * Good Quality, reliable terminal/sockets are provided at appropriate places on panel for connections/observation of waveforms
- * Strongly supported by detailed Operating Instructions, giving details of Object, Theory, Design procedures, Report Suggestions and Book References

Other Apparatus Required:

- * Cathode Ray Oscilloscope 20MHz

Pulse Position Modulation & Demodulation (PPM) Trainer

Order Code - 40505



Experimental Training Board has been designed specifically for the study of Pulse Position Modulation and Demodulation. Using this training board one can know the specialized techniques of Pulse Position Modulation and Demodulation.

Practical experience on this board carries great educative value for Science and Engineering Students.

Object:

01. To modulate a pulse train (carrier) with a sinusoidal signal and to obtain a Pulse Position Modulated signal
02. To demodulate a Pulse Position Modulated signal to recover the modulating signal

Features:

The board consists of the following built in parts :

01. $\pm 6V$ D.C. at 100mA, IC regulated Power Supply internally connected
 02. Pulse Train (Carrier) Generator based on timer IC
 03. 50 Hz A.C. sinusoidal modulating signal obtained from stepped down transformer
 04. Pulse Position Modulating circuit based on IC
 05. Demodulating circuitry based on an IC and transistors
 06. Adequate no. of other electronic components
 07. Mains ON/OFF switch, Fuse and Jewel light
- * The unit is operative on 230V $\pm 10\%$ at 50Hz A.C. Mains
 - * Adequate no. of patch cords stackable from rear both ends 2mm spring loaded plug length $\frac{1}{2}$ metre
 - * Good Quality, reliable terminal/sockets are provided at appropriate places on panel for connections/observation of waveforms
 - * Strongly supported by detailed Operating Instructions, giving details of Object, Theory, Design procedures, Report Suggestions and Book References

Other Apparatus Required:

- * Cathode Ray Oscilloscope 20MHz

Frequency Shift Keying Modulation and Demodulation Trainer

Order Code - 40506



Experimental Training Board has been designed specifically for the study of frequency shift keying modulation and Demodulation. The board is absolutely self contained and requires only CRO. Practical experience on this board carries great educative value for Science and Engineering Students.

Object:

To study the generation of the Frequency Shift Keyed output and also to demodulate the FSK output.

Features:

The board consists of the following built-in parts :

01. $\pm 12V$ D.C. at 20mA IC regulated power supply internally connected
 02. 5V D.C. at 100mA IC regulated power supply internally connected
 03. Quad Op-amp IC
 04. Decade counter IC
 05. Timer IC
 06. 4-Bit Binary counter IC
 07. Quad 2-input Nand gate IC
 08. Two potentiometers for varying the FSK input and demodulator adjust
- * Adequate no. of other electronic components
 - * Mains ON/OFF switch, fuse and jewel light
 - * The unit is operative on 230V $\pm 10\%$ at 50Hz A.C. Mains
 - * Adequate no. of patch cords stackable 4mm spring loaded plug length $\frac{1}{2}$ metre
 - * Good Quality, reliable terminal/sockets are provided at appropriate places on panel for connections/observation of waveforms
 - * Strongly supported by detailed Operating Instructions, giving details of Object, Theory, Design procedures, Report Suggestions and Book References

Other Apparatus Required:

- * Cathode Ray Oscilloscope 20MHz.

Phase Shift Keying Modulation and Demodulation Trainer

Order Code - 40507



Experimental Training Board has been designed specifically for the study the Phase shift keying modulation and Demodulation. The board is absolutely self contained and requires only CRO. Practical experience on this board carries great educative value for Science and Engineering Students.

Object:

To study the generation of the Phase Shift Keyed output

and also to demodulate the PSK output.

Features:

The board consists of the following built-in parts :

01. $\pm 5V$ D.C. at 100mA IC regulated power supply internally connected
 02. Op-Amp IC.
 03. Decade counter IC.
 04. Quad Op-Amp. IC
 05. Multiplexer IC.
 06. Quad, 2-input EX-OR gate IC
 07. Mains ON/OFF switch, fuse and jewel light.
- * The unit is operative on 230V $\pm 10\%$ at 50Hz A.C. Mains.
 - * Adequate no. of patch cords stackable from rear both ends 4mm spring loaded plug length $\frac{1}{2}$ metre.
 - * Good Quality, reliable terminal/sockets are provided at appropriate places on panel for connections/observation of waveforms.
 - * Strongly supported by detailed Operating Instructions, giving details of Object, Theory, Design procedures, Report Suggestions and Book References.

Other Apparatus Required

- * Cathode Ray Oscilloscope 20MHz.

Amplitude Shift Key Modulation And Demodulation Trainer

Order Code - 40508



Experimental Training Board has been designed specifically for the study of Amplitude shift key modulation and Demodulation. The board is absolutely self contained and requires only CRO. Practical experience on this board carries great educative value for Science and Engineering Students.

Object:

To study the generation of the Amplitude Shift Key output and also to demodulate the ASK output.

Features:

The board consists of the following built-in parts :

01. $\pm 12V$ D.C. at 50mA, IC regulated power supply internally connected.
 02. $\pm 5V$ D.C. at 50mA, IC regulated power supply internally connected.
 03. Clock Generator 200Hz to 15KHz.
 04. 8 Bit Word Generator.
 05. Logic Selection switches for high / low (9Nos).
 06. Binary Counter (Divided by 16 counter).
 07. Carrier Signal Generator 4 to 10KHz.
 08. Amplitude Shift Key (ASK) Modulator.
 09. Amplitude Shift Key (ASK) Demodulator.
 10. Mains ON/OFF switch, fuse and jewel light.
- * The unit is operative on 230V $\pm 10\%$ at 50Hz A.C. Mains.
 - * Adequate no. of patch cords stackable 4mm spring loaded plug length $\frac{1}{2}$ metre.
 - * Good Quality, reliable terminal/sockets are provided at appropriate places on panel for connections/observation of waveforms.

- * Strongly supported by detailed Operating Instructions, giving details of Object, Theory, Design procedures, Report Suggestions and Book References.

Other Apparatus Required:

- * Cathode Ray Oscilloscope 20MHz.

Delta Modulation and Demodulation Trainer

Order Code - 40509



Experimental Training Board has been designed specifically for study of delta modulation and demodulation The board is absolutely self contained and requires only CRO. Practical experience on this board carries great educative value for Science and Engineering Students.

Object:

To study delta modulation and demodulation.

Features:

The board consists of the following built-in parts :

01. 5V D.C. at 100mA IC regulated power supply internally connected.
 02. $\pm 12V$ D.C. at 100mA IC regulated power supply internally connected.
 03. Quad Op-Amp IC.
 04. Two Up/Down counter IC.
 05. Digital to Analog convertor DAC IC.
 06. Quad two input NAND gate IC.
 07. Timer IC.
 08. Cooperator IC.
 09. Potentiometer for varying amplitude of modulating signal.
 10. Mains ON/OFF switch, fuse and jewel light.
- * The unit is operative on 230V $\pm 10\%$ at 50Hz A.C. Mains.
 - * Adequate no. of patch cords stackable from rear both ends 4mm spring loaded plug length $\frac{1}{2}$ metre.
 - * Good Quality, reliable terminal/sockets are provided at appropriate places on panel for connections /observation of waveforms.
 - * Strongly supported by detailed Operating Instructions, giving details of Object, Theory, Design procedures, Report Suggestions and Book References.

Other Apparatus Required:

- * Cathode Ray Oscilloscope 20MHz.

Transmission Line Trainer

Order Code - 40510



Experimental Training Board has been designed specifically to study the various parameters in Transmission Line. Practical experience on this board

carries great educative value for Science and Engineering Students.

Object:

To measure the following :

01. Measuring the characteristics of a line
02. Measuring the attenuation of a line
03. Measuring the Input Impedance of the line
04. Phase displacement between the current & voltage at input of line
05. Frequency characteristic of the line
06. Study of Stationary Waves
07. Signal phase shift along the line
08. Fault localization within the line
09. Line under pulsed condition.

Features:

The board consists of the following built-in parts :

01. 4 Nos. Coaxial Cables 25 meters each, total Transmission line 100 metres.
 02. Two potentiometers for impedance matching.
 03. Sine/Square wave Signal Generator having frequency 40KHz to 4MHz, in two bands 40KHz to 400KHz & 400KHz to 4MHz.
 04. A SPDT switch to select either sine or square wave.
 05. A SPDT switch to select frequency either high (400KHz to 4MHz) or low (40KHz to 400KHz).
 06. A potentiometer to vary frequency high (400KHz to 4MHz) or low (40KHz to 400KHz).
 07. A potentiometer to vary amplitude.
 08. BNC connector to connect input.
 09. Adequate no. of other electronic components.
 10. Mains ON/OFF switch, fuse and jewel light.
- * The unit is operative on 230V $\pm 10\%$ at 50Hz A.C. Mains.
 - * Adequate no. of patch cords stackable from rear both ends 4mm spring loaded plug length $\frac{1}{2}$ metre.
 - * Good Quality, reliable terminal/sockets are provided at appropriate places on panel for connections /observation of waveforms.
 - * Strongly supported by detailed Operating Instructions, giving details of Object, Theory, Design procedures, Report Suggestions and Book References.

Other Apparatus Required:

- * Cathode Ray Oscilloscope 20MHz.

Digital Time Division Multiplexing & Demultiplexing Trainer

Order Code - 40511



Experimental Training Board has been designed specifically to study Digital time division multiplexing & demultiplexing. 8 channel Digital Multiplexer and Demultiplexer are provided on the Trainer. A rolling Address Generator scans the 8 channels sequentially. Data Generator with 8 different outputs act as signal sources for the 8 channels.

Practical experience on this board carries great educative value for Science and Engineering Students.

Object:

To study Digital Time Division Multiplexing & Demultiplexing.

Features:

The board consists of the following built-in parts :

- 01. $\pm 5V$ D.C. at 100mA IC regulated power supply internally connected.
- 02. 8 : 1 Multiplexer.
- 03. 1 : 8 Demultiplexer.
- 04. 8 bit Data Generator.
- 05. Clock & Address Generator.
- 06. Mains ON/OFF switch, fuse and jewel light.
- * The unit is operative on 230V $\pm 10\%$ at 50Hz A.C. Mains.
- * Adequate no. of patch cords stackable from rear both ends 4mm spring loaded plug length $\frac{1}{2}$ metre.
- * Good Quality, reliable terminal/sockets are provided at appropriate places on panel for connections /observation of waveforms.
- * Strongly supported by detailed Operating Instructions, giving details of Object, Theory, Design procedures, Report Suggestions and Book References.

Other Apparatus Required:

- * Dual Trace Cathode Ray Oscilloscope 20MHz.

Pulse Code Modulation & Demodulation Trainer

Order Code - 40512



Experimental Training Board has been designed specifically to study Pulse Code Modulation & Demodulation. In the basic PCM Modulator the base band analog signal is covered into 8 bit digital format using an ADC. The sampling rate is set at 2.5 KHz. The 8 bit parallel data from ADC is converted into serial bit stream at 33 kbps.

The PCM Demodulator receives the serial data, converts it into 8 bit parallel format. The Analog to digital converter transforms the 8 bit parallel data into analog level. Thus the output of DAC is a stepped approximation of input signal. A low pass filter is used to recover the analog signal. Practical experience on this board carries great educative value for Science and Engineering Students.

Object:

To study Pulse Code Modulation & Demodulation.

Features:

- The board consists of the following built-in parts :
- 01. 5V D.C. at 100mA IC regulated power supply internally connected.
- 02. $\pm 15V$ D.C. at 100mA IC regulated power supply internally connected.
- 03. + 5V D.C. to -9V Variable D.C. output.
- 04. Built in TTL Clock Generator 33 KHz.
- 05. Modulating Signal Generator 15Hz to 300Hz.
- 06. PCM Encoder.
- 07. PCM Decoder.
- 08. Data display with LED's

- 09. Adequate no. of other electronic components.
- 10. Mains ON/OFF switch, fuse and jewel light.
- * The unit is operative on 230V $\pm 10\%$ at 50Hz A.C. Mains.
- * Adequate no. of patch cords stackable from rear both ends 4mm spring loaded plug length $\frac{1}{2}$ metre.
- * Good Quality, reliable terminal/sockets are provided at appropriate places on panel for connections /observation of waveforms.
- * Strongly supported by detailed Operating Instructions, giving details of Object, Theory, Design procedures, Report Suggestions and Book References.

Other Apparatus Required:

- * Cathode Ray Oscilloscope 20MHz.

Analog Signal Sampling and Reconstruction Trainer

Order Code - 40513



Experimental Training Board has been designed specifically to study of Sampling Theorem using Pulse Amplitude Modulation and Demodulation. The training board is complete in all respect except C.R.O. Practical experience on this set up carries great educative value for Science and Engineering Students.

Object:

To study Sampling Theorem using Pulse Amplitude Modulation and Demodulation.

- 01. To generate PAM signal by modulating with audio signal by natural sampling.
- 02. To generate PAM signal by modulating with audio signal by Flat-Top sampling.
- 03. To generate PAM signal by modulating with audio signal by Sample / Hold circuit.
- 04. To demodulate using Low Pass Filter to reconstruct input(sine wave).

Features:

The board consists of following built in parts :

- 01. $\pm 15V$ D.C. at 100mA, IC Regulated Power Supply.
- 02. +5V D.C. at 100mA, IC Regulated Power Supply.
- 03. A.F. signal generator for modulating signal.
- 04. Sampling clock generator to provide sampling clock and gate pulse.
- 05. Modulator circuit for Flat-top natural and S/H circuit.
- 06. Demodulator circuit to reconstruct input (sinewave).
- 07. Mains ON/OFF switch, Fuse and Jewel light.
- * Adequate no. of patch cords stackable 4mm spring loaded plug length $\frac{1}{2}$ metre.
- * Good Quality, reliable terminal/sockets are provided at appropriate places on panel for connections/observation of waveforms.
- * Strongly supported by detailed Operating Instructions, giving details of Object, Theory, Design procedures, Report Suggestions and Book References.

Other Apparatus Required:

- * Dual Scope Cathode Ray Oscilloscope 20MHz.

Differential Pulse Code Modulation and Demodulation Trainer

Order Code - 40514



Experimental Training Board has been designed specifically to study Differential Pulse Code Modulation & Demodulation. In the basic DPCM Modulator the base band analog signal is covered into 8 bit digital format using an ADC. The sampling rate is set at 2.5 KHz. The DPCM Demodulator receives the serial data, converts it into 8 bit parallel format. The Digital to Analog converter transforms the 8 bit parallel data into analog level. Thus the output of DAC is a stepped approximation of input signal. A low pass filter is used to recover the analog signal. Practical experience on this board carries great educative value for Science and Engineering Students.

Object:

To study Differential Pulse Code Modulation & Demodulation.

Features:

The board consists of the following built-in parts :

01. 5V D.C. at 100mA IC regulated power supply internally connected.
 02. ± 12V D.C. at 100mA IC regulated power supply internally connected.
 03. - 5V D.C. to + 5V D.C. Variable D.C. output.
 04. Audio Frequency Oscillator 10Hz to 100Hz for modulation.
 05. DPCM Modulator (DPCM ENCODER).
 06. DPCM Demodulator (DPCM DECODER).
 07. Adequate no. of other electronic components.
 08. Mains ON/OFF switch, fuse and jewel light.
- * The unit is operative on 230V ±10% at 50Hz A.C. Mains.
 - * Adequate no. of patch cords stackable from rear both ends 4mm spring loaded plug length ½ metre.
 - * Good Quality, reliable terminal/sockets are provided at appropriate places on panel for connections/observation of waveforms.
 - * Strongly supported by detailed Operating Instructions, giving details of Object, Theory, Design procedures, Report Suggestions and Book References.

Other Apparatus Required:

- * Dual Trace Cathode Ray Oscilloscope 20MHz.

Differential Phase Shift Keying Modulation and Demodulation Trainer

Order Code - 40515



To study Differential Phase Shift Keying Modulation and Demodulation.

Features:

The board consists of the following built-in parts :

01. ± 5V D.C. at 100mA IC regulated Power Supply internally connected.
 02. IC-1 for generating DPSK (Differential Phase Shift Keying) signal.
 03. IC-5 for generating Carrier signals.
 04. IC-2A for generating Bit Clock.
 05. IC-6 for generating different Datas.
 06. IC-2 B & C, IC-3 C & D, IC-4 D-FF2 and Transistor 2, 3 & 4 are used as Demodulator.
 07. Adequate no. of other electronic components.
 08. Mains ON/OFF switch, fuse and jewel light.
- * The unit is operative on 230V ±10% at 50Hz A.C. Mains.
 - * Adequate no. of patch cords stackable from rear both ends 4mm spring loaded plug length ½ metre.
 - * Good Quality, reliable terminal/sockets are provided at appropriate places on panel for connections/observation of waveforms.
 - * Strongly supported by detailed Operating Instructions, giving details of Object, Theory, Design procedures, Report Suggestions and Book References.

Other Apparatus Required:

- * Dual Trace Cathode Ray Oscilloscope 20MHz

DSB / SSB-SC Amplitude Modulation & Demodulation Trainer

Order Code - 40516



DSB/SSB-SC Amplitude Modulation & Demodulation Trainer has been designed with a view to provide practical and experimental knowledge of Amplitude Modulation / Demodulation technique as practically implemented in Analog Communication system on a SINGLE P.C.B. of size 300x400mm.

Object:

To Study of

01. Amplitude Modulation & Demodulation.
 - 1.1 Generate AM signal by modulation with audio signal generator
 - 1.2 Measure modulation index of A.M. signal
 - 1.3 Demodulate AM signal using diode detector(envelope detector)
 - 1.4 Generate voice signal AM modulation and demodulation using Mic.
 - 1.5 Observe the effect of DC signal input on AM output
 - 1.6 Demodulate AM signal by square law detection
02. DSB-SC Amplitude Modulation & Demodulation.
 - 2.1 Generate DSB-SC AM signal
 - 2.2 Demodulate DSB-SC signal using product detector
03. SSB-SC Amplitude Modulation & Demodulation
 - 3.1 Generate SSB-SC AM signal
 - 3.2 Demodulate SSB-SC signal using product detector

Feature:

The board consists of the following built-in parts:

01. IC REGULATED POWER SUPPLY : ± 15 DC and +5V DC at 100mA.
02. AF Modulation signal generator : Sine wave

- Frequency Range : 300 Hz to 3.4 KHz
Amplitude : 0 to 5 Vpp.
03. RF carrier signal oscillator.
Frequency Range : 100 KHz to 1 MHz.
Amplitude : 0 to 10 Vpp.
 04. Local Oscillator : 400 KHz to 500 KHz.
 05. Band Pass Filter : 452 KHz to 458 KHz.
 06. DC Source Variable power supply to see the effect of DC on the output waveform : - 5 to + 5 VDC
 07. Output Audio amplifier with Volume Control.
 08. Input Audio amplifier for modulating external signal from Mike or Tape recorder.
 09. Duple Balanced Amplitude modulator
 10. Diode detector.
 11. Product detector
 12. Low pass filter.
 13. Power supply requirement 230V AC, 50 Hz.
 14. Mains ON/OFF switch, fuse and jewel light.
 15. Dynamic Microphone with 4mm Jack Pin.
 16. Loud Speaker with baffle fitted in a box with two metre wire and 2mm Banana pins for connections.
- * Good Quality, reliable terminal/sockets are provided at appropriate places on panel for connections/ observation of waveforms.
 - * Strongly supported by detailed Operating Instructions, giving details of Object, Theory, Design Procedures, Report Suggestions and Book References.

Other Apparatus Required:

- * Cathode Ray Oscilloscope 20MHz.

DSB / SSB AM Transmitter Trainer

Order Code - 40517



This trainer has been designed with a view to provide practical and experimental knowledge of DSB / SSB AM Transmitter technique as practically implemented in Analog Communication system on a signal P.C.B. of size 300x400mm.

Object:

01. Study of carrier frequency generation.
02. Study of DSB / SSB AM Generation & Transmission.
03. Study of Transmitter tuned circuits.

Feature:

The board consists of the following built-in parts:

01. AF Modulating signal generator : Sine wave
Frequency Range : 300 Hz to 3.4 KHz
Amplitude : 0 to 5 Vpp.
02. RF carrier signal oscillator
Frequency Range : 100 KHz to 1 Mhz.
Amplitude : 0 to 10 Vpp.
03. Modulators (Two Nos) : Double Balanced Amplitude modulator
04. Ceramic Band Pass Filter : 452 KHz to 458 KHz.
05. Band Pass Filter : 1 No.
06. Switch faults : 8 Nos.
07. POWER SUPPLY : ± 12DC and +5V DC IC Regulated power supply.
08. Test points : 27 Nos.
09. BFO Oscillator : 455 KHz.

10. Input Audio amplifier with Volume Control for modulating external signal from Mike or Tape recorder.
 11. Output Amplifier Transmitter : (Gain adjustable) DSB (1MHz), SSB (1.445 MHz) connected to Antenna/cable.
 12. Mains ON/OFF switch, fuse and jewel light.
 13. Power supply requirement 230V AC, 50 Hz.
 14. Dynamic Microphone with 4mm Jack Pin.
- * Good Quality, reliable terminal/sockets are provided at appropriate places on panel for connections/ observation of waveforms.
 - * Strongly supported by detailed Operating Instructions, giving details of Object, Theory, Design Procedures, Report Suggestions and Book References.

Other Apparatus Required:

- * Cathode Ray Oscilloscope of 20MHz.

DSB / SSB AM Receiver Trainer

Order Code - 40518



DSB / SSB AM Receiver trainer this trainer has been designed with a view to provide practical and experimental knowledge of DSB / SSB AM Receiver technique as practically implemented in Analog Communication system on a signal P.C.B. of size 300x400mm

Object:

01. Study of DSB & SSB AM reception & deletion by diode / product detectors.
02. Study of AGC.
03. Study of receiver tuned circuits.
04. Study of Sensitivity, Selectivity & Fidelity of Receiver.

Feature:

The board consists of the following built-in parts:

01. POWER SUPPLY : ± 12DC and +5V DC IC Regulated power supply.
02. Detectors/Demodulator : 1. Diode Detector (For DSB) : 2. Product Detector (For SSB)
03. Frequency Range : 980KHz to 1650 KHz.
04. Intermediate frequency : 455 KHz.
05. Input Circuits
 - : 1. RF Amplifier
 - : 2. Mixer
 - : 3. 1st Amplifier
 - : 4. 2nd Amplifier
 - : 5. Local oscillator
 - : 6. Envelope Detector (AGC)
 - : 7. Switch Fault
 - : 8. Product Detector
 - : 9. IC Regulated Power Supply
 - : 10. Beat frequency oscillator / 455 KHz Crystal oscillator
 - : 11. Output Audio Amplifier
06. Receiving media : Telescopic Antenna / cable.
07. Tuning : with variable capacitor.
08. Switched faults : 8Nos.
09. Test points : 50.

10. Power supply requirement : 230V AC, 50 Hz.
11. Mains ON/OFF switch, fuse and LED.
12. Audio Output amplifier with Volume Control.
13. Loud Speaker with baffle fitted in a box with two metre wire and 2mm Banana pins for connections.
- * Adequate no. of patch cords stackable from rear both ends 2mm spring loaded plug length ½ metre.
- * Good Quality, reliable terminal/sockets are provided at appropriate places on panel for connections/ observation of waveforms.
- * Strongly supported by detailed Operating Instructions, giving details of Object, Theory, Design Procedures, Report Suggestions and Book References.

Experiments:

01. Study of double sideband AM reception using envelope detector via cable.
02. Study of double sideband AM reception using envelope detector via Antenna.
03. Study of sensitivity, selectivity, of a radio receiver.
04. Study of single sideband AM reception using product detector.
05. Study of Image frequencies.
06. Voice transmission with DSB AM transmission / reception.

Other Apparatus Required:

- * Cathode Ray Oscilloscope 20MHz.

Frequency Modulation & Demodulation Trainer

Order Code - 40519



FM Transmitter and Receiver Trainer has been designed with a view to provide practical and experimental knowledge of Frequency Modulation / Demodulation technique as practically implemented in Analog Communication system on a SINGLE P.C.B. of size 300x400mm.

Object:

To Study Theory of Frequency Modulation & Demodulation:

01. Frequency Modulation via varactor / reactance Modulation.
02. Frequency Demodulation via Detuned Resonant / Ratio / Qudrature / Foster - Seeley / Phase locked loop detector.
03. Separate VCO circuit to demonstrate FM waveform.

Feature:

The board consists of the following built-in parts:

01. POWER SUPPLY : ± 12DC IC Regulated power supply.
02. FM Modulating signal generator : Sine wave Frequency Range : 300 Hz to 3.4 KHz Amplitude Range : 0 to 5 Vpp.
03. Modulator Type : Varactor modulator (With carrier frequency adjustment) : Reactance Modulator (With carrier frequency adjustment)
04. Demodulator : Detuned resonant detector. : Quadrature detector : Foster - Seeley Detector : Ratio Detector : Phase locked loop Detector

05. Mixer/Amplifier : 1 No. (With gain adjustment) Allows FM input signal to be amplitude modulated by a noise input to demodulation.
06. Low pass Filter : 3.4 KHz. Cut of frequency Amplifier (with adjustable gain)
07. VCO Circuit : FM Wave form demonstrate
08. Test Point : 78
09. Power supply requirement : 230VAC, 50 Hz.
10. On Board Switched Faults : 8 Nos.
11. On Board Amplitude limiter with Amplitude control.
12. Input - Output and Test points provided on board.
13. A self contained Trainer.
14. Effect of noise on the detection of FM signal may be investigated.
- * Good Quality, reliable terminal/sockets are provided at appropriate places on panel for connections/ observation of waveforms.
- * Strongly supported by detailed Operating Instructions, giving details of Object, Theory, Design procedures, Report Suggestions and Book References.
- * Weight : 6 Kg. (Approx.)
- * Dimension : W 412 x H 150 x D 310

Other Apparatus Required:

- * Cathode Ray Oscilloscope 20MHz.
- * Patch Cords

DSB/SSB AM Transmitter Trainer

Order Code - 40520



Features:

01. Crystal controlled carrier frequency
02. On-board Audio Oscillator, Modulators,
03. BP Filters, 455 KHz Generator, Transmitting Antenna and Speaker

Technical Specifications:

- Audio Oscillator : With adjustable Amplitude & Frequency (300 Hz - 3.4 KHz)
- Audio Output : Amplifier with speaker
- Modulators : Balanced Modulator with Band pass Filter (1 MHz) - 2 Nos. Balanced Modulator (455 KHz) - 1 No. Ceramic Bandpass Filter - 1 No.
- Carrier Frequency : 1 MHz (Crystal controlled)
- Transmitter Amplifier Output : (Gain adjustable) DSB (1 MHz), SSB (1.445 MHz) connected to Antenna/cable
- Switched Faults : 8 Nos.
- Interconnections : 4mm Banana Socket
- Test Points : 27
- Power Supply : 220 V ± 10 %, 50 Hz / 60 Hz on request
- Power Consumption : 4 VA (approx.)
- Dimension (mm.) : W 340 × D 241 × H 105
- Weight : 2.8 Kg (approx.)
- Accessories : Line cord, Manual, Set of patch cords

Experiments:

- 01. Study of carrier frequency generation
- 02. Study of DSB & SSB AM generation & Transmission
- 03. Study of Transmitter tuned circuits
- 04. Study of Modulation index

DSB/SSB AM Receiver Trainer

Order Code - 40521



Features:

- 01. Variable capacitor tuning
- 02. On-board LO, BFO, RF Amp, Mixer, IF Amps., Detectors, Audio output Receiving Antenna, AGC & Speaker

Technical Specifications:

- Construction : Superhetrodyne
- Freq. Range : 980 KHz to 2060 KHz
- Intermediate Frequency: 455 KHz
- Input Circuits :
 - 1) RF Amplifier
 - 2) Mixer
 - 3) Local Oscillator
 - 4) Beat Frequency Oscillator
 - 5) IF Amplifier 1
 - 6) IF Amplifier 2
- Tuning : With Variable Capacitor (ganged) Dial marking on Board
- Receiving media : Telescopic Antenna / Cable
- Detectors :
 - 1) Diode Detector (For DSB)
 - 2) Product Detector (SSB)
- Audio Output : Amplifier with Speaker
- Automatic Gain control : Switchable
- Switched Faults : 8 Nos.
- Interconnections : 4 mm Banana Sockets
- Test points : 50
- Power Supply : 220 V \pm 10 %, 50 Hz / 60 Hz on request
- Power Consumption : 3 VA (approx.)
- Accessories : Line cord, Manual, Set of patch cords

Experiments:

- 01. Study of DSB & SSB AM reception & detection by diode / product detectors
- 02. Study of AGC
- 03. Study of Receiver tuned circuits
- 04. Study of Sensitivity, Selectivity & Fidelity of Receiver

Frequency Modulation / Demodulation Trainer

Order Code - 40522



On-board Audio Oscillator, Modulators, Detectors, Amplitude Limiter & Filter

Technical Specifications:

- Audio Oscillator : With adjustable Amplitude &

- Frequency (300 Hz - 3.4 KHz)
- FM Modulator : 2 Nos.
 - 1) Reactance Modulator (with carrier Frequency adjustment)
 - 2) Varactor Modulator (with carrier Frequency adjustment)
- Mixer / Amplifier : 1 No. (With Gain adjustment) Allows FM input signal to be amplitude modulated by a noise input prior to demodulation.
- Transmitter output Freq : 455 KHz
- FM Demodulator : 5 Nos.
 - 1) Detuned Resonant Detector
 - 2) Quadrature Detector
 - 3) Foster-Seeley Detector
 - 4) Ratio - Detector
 - 5) Phase Locked Loop Detector
- Low Pass Filter : 3.4 KHz Cut off Frequency
- Amplifier (with adjustable gain)
- Amplitude Limiter : 1 No.
- Switched Faults : 8 Nos.
- Interconnections : 4 mm banana sockets
- Test points : 74
- Power Supply : 220 V \pm 10 %, 50 Hz / 60 Hz on request
- Power Consumption : 3 VA (approx.)
- Accessories : Line cord, Manual, Set of patch cords

Experiments:

- 01. Study of 2 types of FM modulators & 5 different types of demodulators
- 02. Effect of noise on FM transmission & Study of tuned circuits
- 03. Separate VCO circuit to demonstrate FM Waveforms

FM Communication Trainer

Order Code - 40523



Technical Specifications:

- Generator**
- Waveforms : Sine
- Amplitude : Adjustable from 0 - 4 Vpp
- Frequency : Adjustable from 0.1 to 1 KHz & 1 to 10 KHz
- VCO 1**
- Output signal : Sine
- Frequency : 400 KHz to 1500 KHz
- Amplitude : Adjustable from 0-2 VPP
- Inputs : Modulating signal
- VCO2**
- Output signal : Sine
- Frequency : Switching on 2 ranges 400 KHz to 500 KHz and 500 KHz to 1500 KHz

Amplitude Input	: Adjustable from 0- 2 VPP : Modulating Signal, Marker
Sweep	
Frequency	: 7 Hz
Depth	: Adjustable
RF Detector	: Input level adjustable
Balanced Modulator	: Adjustable output amplitude & Adjustable carrier null
Ceramic filter	: Central frequency 455 KHz
Bandwidth	: 3 ± 1 KHz
Low pass filter	: Cut off frequency 10 KHz
PLL Detector	: 1 Nos.
Interconnections	: 4mm. banana sockets
Test Points	: 8 Nos.
Power Supply	: 220 V ± 10 %, 50 Hz / 60 Hz on request
Power Consumption	: 2.5 VA(approx.)
Accessories	: Line cord, manual and patch cords

Experiments:

01. Frequency deviation and modulation index
02. Marker insertion to evaluate frequency deviation
03. Spectrum of FM signal
04. FM demodulation (PLL Detector)

Noise Audio - Amplifier Trainer

Order Code - 40524

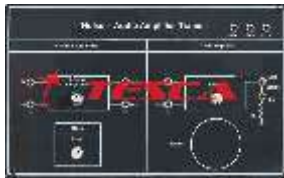

Technical Specifications:

Noise Generator	: Output Amplifier Adjustable from 100 mVpp
Signal Attenuation Network	: Adjustable from 0 to the maximum of input value.
Signal	: +Noise adder stage
Audio Amplifier with Loud speaker	: 8W, 0.25 W
Dimensions (mm.)	: W 255 x D 155 x H 80
Power Supply	: +12 V (From AD-01)

Experiments:

01. Examine the operation of a noise generator
02. Examine the operation of a signal attenuation network
03. Measurement of the frequency response and power output

Synchro AM Detector

Order Code - 40525



In any receiver a key element is the detector. Its purpose is to remove the modulation from the carrier to give the audio frequency representation of the signal. Synchronous detection is used for the detection or

demodulation of Amplitude Modulation (AM). This form of modulation is still widely used for broadcasting on the long, medium and short wave bands despite the fact that there are more efficient forms of modulation that can be used today. Synchronous detectors are considerably more complex than simple envelope detectors. 40525 Synchronous AM Detector is a experiment platform with both modulator and synchronous detector for demodulation. This provide Students the basic knowledge of how a synchronous detector works, and students can also measure the modulation index and observe the different waveform for Amplitude Modulation. 40525 comes with inbuilt Power Supply.

Features:

01. A self contained learning platform
02. Functional blocks indicated on board mimic
03. On board modulator and demodulator
04. Input-output and test points provided onboard
05. Built in DC Power Supply
06. Compact size
07. Online Product Tutorial

Technical Specifications:

Function	: Sine
Block Diagram	: 1.Modulator AM modulator 2.Demodulator I. AM modulator II. Low pass circuit
Mains Supply	: 230V ± 10 %, 50Hz
Test Points	: 8 nos
Power Consumption	: 3VA (approximately)
Interconnections	: 2mm Banana sockets
Dimensions (mm)	: W 255 W x H 155 x D 55
Weight	: 2 Kg (approximately)
Patch cord (Red) 2mm 16"	: 4 nos.
Patch cord (Black) 2mm 16"	: 4 nos.
Patch cord (Blue) 2mm 16"	: 2 nos.
Mains cord	: 1 no.

Experiments:

01. Study and observe the working of Amplitude Modulator
02. Study and observe frequency of Synchronous detector

Frequency Division Multiplexer / Demultiplexer Trainer

Order Code - 40526



FDM trainer demonstrates FDM technique. Two different modulated inputs can be transmitted as a single communication line using FDM The trainer is self contained and all the inputs are on board.

Features:

01. Self contained and easy to operate
02. Two variable modulating (sinusoidal) input channels with provision of voice inputs
03. Two DSBSC modulators for frequency band translation of two test signals

04. Two Carrier Generators
05. Two Sets of Audio input Amplifier
06. One adder/transmission Amplifier
07. Two Demodulators
08. Two low pass filters for smooth output

Technical Specifications:

Carrier Generator	: Sine wave 100 KHz & 200 KHz Modulating Input
Frequency	: Sinewave 1 KHz -10 KHz (variable)
Audio Input Amplifier	: Gain of 100 (approx.)
Modulator / Demodulator	: DSBSC Modulator /Demodulator
Low Pass Filters	: Second Order Butter worth Filters with a cut off frequency of 10 KHz
Audio Output Amplifier	: Output Amplifier with a gain of 20
Test points	: 30
Interconnection	: 4mm banana socket
Power Supply	: 220 V \pm 10 %, 50 Hz / 60 Hz on request
Power Consumption	: 3 VA(approx.)
Dimension (mm)	: W 340 \times D 240 \times H 105
Weight	: 3.5 Kg (approx.)
Accessories	: Microphones, Headphones, Patch Cords, Manual and Mains Cord

Experiments:

01. Study of Frequency Division Multiplexing /
02. Demultiplexing with sinusoidal & audio inputs
03. Study of Fourier Spectrum of FDM
04. Study of DSBSC modulation/Demodulation
05. Study of Fourier Transform of DSBSC Modulation and many more...

Sampling & Reconstruction Trainer

Order Code - 40527



The trainer provides all necessary inputs and connection for students to study signal Sampling and Reconstruction Techniques.

Features:

01. Crystal controlled pulse generator
02. Demonstrates sampling and reconstructed as per
03. Nyquist criterion
04. On-board synchronized analog signal generator
05. Six, switch selectable sampling frequencies
06. Sampling pulse duty-cycle selectable
07. Internal/ External sampling signal selectable
08. Separate sample and sample/hold outputs available
09. On-board second order and fourth order low-pass filters
10. Audio Input and Output links to show the transmission and reception of real time signal (audio signal)

Technical Specifications:

Crystal Frequency	: 8 MHz
Sampling Frequency	: 2, 5, 8,10, 20 & 40 KHz (switch

On-board Generator	: Synchronized 1 KHz sine wave (5 V) pp
Duty cycle	: 0 - 90% in Decade steps (Switch Selectable)
Low -Pass Filters	: Butterworth 2nd & 4th order Cut-off frequency - 3.4 KHz each
Test Point	: 50
Interconnections	: 2 mm sockets
Power Supply	: 220 V \pm 10%, 50 / 60 Hz on request
Power Consumption	: 3 VA (approx.)

Experiments:

01. Signal Sampling and Reconstruction Technique
02. Study of Nyquist criteria for sampling & reconstruction
03. Aliasing & Effect on Reconstruction of Signal due to various Sampling Frequencies
04. Effect on Amplitude of Reconstructed signal by varying Sampling
05. Pulse Duty Cycle in Sample & Sample/Hold output
06. Comparison of 2nd & 4 th Order Butterworth Filters
08. Signal Sampling and Reconstruction using External sampling signal and audio signal

TDM Pulse Amplitude Modulation/ Demodulation Trainer

Order Code - 40528



The trainer provides all necessary inputs and connections for students to study Pulse Amplitude Modulation/ Demodulation techniques. Time Division Multiplexing & Demultiplexing of Signals and Signal Reconstruction.

Features:

01. Crystal controlled clock
02. On-board sine wave generator (synchronized)
03. On-board pulse generator
04. 4 Analog input channels sampled and time division multiplexed
05. Four switch selectable sampling frequencies
06. Pulse duty cycle selectable
07. Internal/External sampling selectable 4 Channel De-multiplexer
08. Generation of clock at receiver by PLL System
09. 4th Order Butterworth L.P. Filter

Technical Specifications:

Crystal Frequency	: 8 MHz
Analog Input Channels	: 4
Multiplexing	: Time Division Multiplexing
Modulation	: Pulse Amplitude Modulation
On Board Analog Signal:	500 Hz, 1 KHz, 2 KHz and 4 K h z (S i n e w a v e synchronized to sampling pulse) Adjustable amplitude and separate variable DC level)
Sampling Rate	: Four sampling signals 4 KHz / 8 KHz / 10 KHz / 20 KHz per

Sampling Pulse	: channel (switch selectable) : With duty cycle variable from 0-90% in decade steps.
Clock Regeneration at Receiver	: Using PLL
Test points	: 50
Interconnections	: 2 mm Sockets
Power Supply	: 220 V \pm 10%, 50 Hz / 60 Hz on request
Power Consumption	: 4 VA (approx.)
Dimensions (mm)	: W 340 \times D 240 \times H 105
Weight	: 1.3 Kg (approx.)

Experiments:

01. Pulse Amplitude Modulation technique
02. Time Division Multiplexing and Demultiplexing
03. PLL as Frequency Multiplier to generate clock from sync signal
04. 3 modes of operation to regenerate original signal
 - a) 3 connections between transmitter & receiver (Clock, sync & information)
 - b) 2 connections (information, sync) Clock regenerated at receiver
 - c) 1 connection (information only) Clock and sync derived at receiver
05. Effect of varying duty cycle of Sampling Pulse on signal reconstruction
06. Effect of different sampling frequencies on TDM-PAM & Demod technique

TDM Pulse Code Modulation/ Transmitter Trainer

Order Code - 40529



The trainer provides all necessary inputs and connection for students to study Pulse Code Modulation Transmission techniques. A communication link can be established by using PCM receiver.

Features:

01. Crystal Controlled Clock
02. On-board Sine wave generator (Synchronized)
03. 2 TDM Analog Channels
04. PCM Transmitter
05. Fast & Slow modes for real time operation and data flow examination
06. Error check code options (odd-even parity, Hamming Code)
07. 4 Switched faults allow different Error Check Options
08. PC - PC Communication via RS232 interface

Technical Specifications:

Crystal Frequency	: 16 MHz
On Board Analog Signal	: 2 KHz, 4 KHz (sine wave synchronized to sampling pulse Adjustable amplitude and separate variable DC level)
Input Channels	: Two
Multiplexing	: Time Division Multiplexing
Modulation	: Pulse Code Modulation
Sync Signal	: Pseudo random sync code

Error Check Code	: generator : Off - Odd - Even - Hamming
Operating Mode : Fast	: 320 KHz / channel (approx.)
Slow	: 1.9 Hz / channel (approx.)
PC -PC communication	: Using 2 channels via RS232
Port	: 9 Pin D type connector - 2Nos.
Baud Rate	: Selectable from 300 to 2400
Test Points	: 50
Interconnections	: 2 mm Sockets
Power Supply	: 220 V \pm 10%, 50 Hz / 60 Hz on request
Power Consumption	: 4 VA (approx.)

Experiments:

01. Pulse Code Modulation
02. A/D Converter, Parallel to Serial Data conversion
03. Time Division Multiplexing of PCM Data
04. Synchronization by Pseudo random Code
05. Error Check Codes with switched faults
06. Connecting modes between transmitters & receiver (1) Sync, clock, data lines connected (2) Clock, data connected (3) Data
07. Study of the effect of induced faults
08. PC-PC communication in 3 modes

TDM Pulse Code Modulation Receiver Trainer

Order Code - 40530



The trainer provides all necessary inputs and connection for students to study decoding and demultiplexing of data transmitted by PCM transmitter. On-Board PLL provides regeneration of Clock. Synchronization between transmitter and receiver is provided by Pseudo random code.

Features:

01. Input accepts two channel multiplexed data
02. On board De-multiplexed PCM Receiver
03. On board L. P. Filter
04. Fast & Slow modes for real time operation and data flow examination
05. On board PLL for clock regeneration
06. On board sync code detector
07. Error +check code options
08. Odd or Even Parity-Single bit error detection
09. Hamming code single bit error detection and correction
10. 4 Switched faults allow different error check code option
11. PC - PC Communication via RS232 interface

Technical Specifications:

Input Channel	: Time Division Multiplexed Serial Input
Demodulation	: Pulse code Demodulation
Clock Regeneration	: By phase Locked loop
Operating Speeds	: Fast - 320 KHz/Channel, Slow 1.9 Hz / Channel

- Error Detection (Single bit) : Off-Odd- Even parity & Hamming code
- Error Correction : Hamming code
- PC- PC communication : using 2 channels via RS232
- Port : 9 pin D type connector - 2 Nos.
- Baud rate : Selectable from 300 to 2400
- Test Points : 50
- Interconnections : 2 mm sockets
- Power Supply : 220 V \pm 10%, 50Hz / 60 Hz on request
- Power Consumption : 4 VA (approx.)

Experiments:

01. PCM Demodulation Technique
02. Time Division Demultiplexing of PCM data
03. Clock Regeneration by PLL
04. Effect of induced faults in the transmitter & receiver
05. Signal recovery in 3 connecting modes between transmitter & receiver
06. Clock & Frame Synchronization in PCM system
07. PC -PC communication in 3 modes

Delta, Adaptive Delta and Delta Sigma Modulation / Demodulation Trainer

Order Code - 40531



In digital communication specially operating at low frequencies or speech communications a saving in Bandwidth can be resulted using Delta Modulation and its associated techniques because this requires single encoding of sample. This Trainer covers Delta, Adaptive Delta and Delta sigma Modulation and Demodulation.

Technical Specifications:

- Crystal Frequency : 6.400 MHz
- Sampling Clock Frequency : 50, 100, 200 & 400 KHz (Switch selectable)
- On board Generator : Synchronized & Adjustable Amplitude Sine Wave Generator of 1 KHz, 2 KHz, 3 KHz, 4 KHz Separate Variable D.C. level
- Integrator : Four integrator gain settings Normal, X 2, X 4, X 8
- Low Pass Filter : Fourth order Butterworth (Cut Off Frequency 4.8 KHz)
- Test Points : 43
- Interconnections : 2 mm socket
- Power Supply : 220 V \pm 10%, 50 Hz / 60 Hz on request
- Power Consumption : 4 VA (approx.)

Features:

01. Transmitter and Receiver on same board
02. Clock generation from crystal
03. Switch selectable sampling rates
04. Four on-board generators at 4 different frequencies (synchronized)
05. Separate adjustable DC level

06. Selectable integrator gain setting (by switch or control circuit)
07. On board 4th order Butterworth low pass filter
08. Unipolar to Bipolar converter on board

Experiments that can be performed

01. Delta Modulation & Demodulation
02. Effect of slope overload and increased integrator gain in Delta Modulation

Adaptive Delta Modulation & Demodulation

01. Delta Sigma Modulation & Demodulation
02. Amplitude overload in Delta Sigma Modulation

Data Formatting and Carrier Modulation/ Transmitter Trainer

Order Code - 40532

In digital communication Data Formatting is very important. The available data stream from PCM transmitter or data from Variable Data Generator is converted into different formats best suited to individual transmission system. Various formats are covered in this trainer. This trainer also covers various carrier modulation techniques required for transmission of digital information. This trainer requires either TDM Pulse Code Modulation Transmitter Trainer Order Code 40529 or 8 Bit Variable Data Generator Order Code 40537 for the input of digital data.

Features:

01. On-board Carrier generation circuit (Sine waves synchronized to transmitter data)
02. On-board in phase and quadrature phase carrier for QPSK modulation and DQPSK
03. Different data conditioning formats NRZ (L), NRZ (M), RZ, Biphase(Manchester), Biphase (Mark), AMI, RB, differentially encoded dibit pair
04. FSK, PSK, ASK, QPSK & DQPSK carrier modulation
05. Variable carrier and modulation Off-Set
06. Variable carrier gain
07. On-board Unipolar to Bipolar conversion
08. On-board data inverter.

Technical Specifications:

- Input : Two channel time division multiplexed data.
- Data formats : NRZ (L), NRZ (M), RZ, AMI, RB, Biphase (Manchester), Biphase (Mark)
- Carrier modulation : ASK, FSK, PSK, DPSK, QPSK
- On-board carrier : Sine waves synchronized to transmitted data at 1.6 MHz, 960 KHz, (0 deg. Phase) 960 KHz, (90 deg. phase)
- Interconnections : 2 mm sockets
- Power Supply : 220 V \pm 10%, 50 Hz / 60 Hz on request
- Power Consumption : 4 VA (approx.)

Experiments:

01. Conversion of NRZ data to other data formats NRZ (L), NRZ (M) RZ, AMI, RB, Biphase (Manchester), Biphase (Mark), Differentially encoded dibit pair
02. ASK, FSK, BPSK, DPSK, QPSK & DQPSK Carrier Modulation Techniques & their comparison

Data Reformatting & Carrier Demodulation Receiver Trainer

Order Code - 40533

Data formatting & carrier modulation done can be demodulated and reformatted by using this trainer.

Features:

01. 7 different data reconditioning formats NRZ (M),
02. RZ, AMI, RB Biphase (Manchester), Biphase (Mark), differentially encoded dibit to NRZ data
03. ASK, FSK, PSK, DPSK ,QPSK & DQPSK carrier demodulation
04. Output gives 2 Channels TDM multiplexed data output
05. On - Board Biphase Clock recovery circuit
06. On - Board data squaring circuit and differential decoder
07. On - Board Butterworth filters - 4th Order (2 nos.)

Technical Specifications:

- Input : From Data Formating & Carrier Modulation Transmitter Trainer
- Output : 2 Channel TDM Multiplexed data stream Demodulation
- options : NRZ (M), RZ, AMI, RB, Biphase (Manchester), Biphase (Mark), differentially encoded dibit to NRZ (L)
- Carrier Demodulation : ASK - Rectifier Diode FSK - PLL Detector PSK / DPSK- Square Loop Detector QPSK/DQPSK- Fourth Power Loop Detector
- Biphase Clock Recovery : By PLL
- Interconnections : 2 mm Sockets
- Power Supply : 220 V ±10%, 50 Hz / 60 Hz on request
- Power Consumption : 2 VA (approx.)

Experiments:

01. Study of Conversion of different data formats to NRZ data format.
02. Various Carrier Demodulation Techniques ASK, FSK, BPSK, DPSK, QPSK & DQPSK

PAM-PPM-PWM Modulation And Demodulation Trainer

Order Code - 40536



PAM-PPM-PWM are the basic Pulse Modulation techniques. The trainer provides complete set up to the students for performing experiments on these techniques. They can study Sampling, Pulse Modulation, Demodulation & Signal reconstruction process. Separate circuits are provided for each technique. The Operating Manual provides technology details and procedure to perform the experiments.

Technical Specifications:

Pulse Modulation Techniques :

1. Pulse Amplitude Modulation
2. Pulse Width Modulation
3. Pulse Position Modulation

On-board Sampling

Frequencies (Pulse) : 8 KHz, 16 Khz, 32 KHz, 64 KHz

On-board Generator :

1. Sinewave : 1 KHz & 2 KHz (Gain Adjustable)
2. Squarewave : 1KHz & 2 Khz
- Low Pass Filter : 4Th order BW Filter
- Voice Communication : Voice Link using dynamic mic & speaker
- AC Amplifier : With Adjustable Gain Control
- DC Output : 0-4 V (Variable)
- Switched Faults : 8 Nos.
- Interconnections : 4mm Banana Sockets
- Test Points : 29
- Power Supply : 220 V ±10 %, 50 Hz / 60 Hz on request
- Power Consumption : 3 VA(approx.)
- Dimensions (mm) : W 340 × D 241 × H 105
- Weight : 2.8 Kg (approx.)
- Accessories : Manual, Set of patch cord, Line cord, Microphone, Headphone

Features:

01. PAM-PPM-PWM Modulation & Demodulation techniques, using Natural & Flat-top sampling.
02. Analog Sample, Sample & Hold and Flat-top outputs.
03. Selectable 4 different sampling pulse frequencies on board.
04. Input-output and test points provided on board.
05. Voice Communication using dynamic microphone & speaker
06. On-board Filter and AC Amplifier
07. 8 Switched Faults
08. Built in DC Power Supply.

Experiments that can be performed

01. PAM using Natural & Flat Top sampling
02. Sample, Sample & Hold & Flat-top outputs in PAM
03. PPM using DC & AC (sinewave) modulating signals
04. Pulse Position Demodulation
05. Pulse width Modulation & Demodulation

Differential Pulse Code Modulation (DPCM) Trainer

Order Code - 40539



DPCM Trainer is a manifestation of our increasing efforts to present the modern technology in a best way to the people who want to unfold the mysteries behind the ever increasing communication super highway. To present it in a best way the trainer incorporates the practical operating frequencies for sampling, audio processing and data processing which are commonly used in our public telephone networks.

Features:

01. Onboard DPCM Transmitter and receiver.
02. Onboard Signal generator block.

- 03. Onboard Audio input processing circuit.
- 04. Onboard audio output processing circuit.
- 05. Clock and entire control Signal section.
- 06. Detailed signal processing circuit with complete data and control signal flow.

Technical Specifications:

Signal generator block

- Functions : Sine and Square
- O/P frequency range : 300 Hz to 3.4 KHz
- Audio blocks : Audio I/P and O/P processing circuits
- Control signals : R/W for ADC, reset, Latch enables, OEs
- Sampling frequency : 8 KHz
- Bits per sample : 5 bits including sign bit

Bandwidth improvement

- Compared to 8 bit PCM: 3 bits per sample.
- Interconnections : 2 mm socket
- Power Supply : ± 5V, ± 12V DC, 200 mA

MSK Modulation / Demodulation Trainer

Order Code - 40541



MSK Modulation / Demodulation Trainer is designed to assist students to understand the basic working principal of Minimum Shift keying technique. As the name suggests, MSK results in a modulation scheme which has smooth phase variations in contrast to other phase modulation schemes where the modulated signal contains abrupt phase changes. The immediate advantage of such a scheme is the reduction in modulated signal bandwidth. MSK Modulation / Demodulation comprises of following major blocks :

- * Digital data generator
- * Sine and Cosine wave generator for wave shaping
- * Sine and Cosine carrier generator
- * Clock signal generator
- * MSK modulator and Demodulator sections with complete signal flow

Features:

- 01. Self contained and easy to use
- 02. Functional blocks indicated on board mimic
- 03. On board Data Generator
- 04. On board Carrier Generator
- 05. On board clock generators
- 06. MSK Modulator
- 07. MSK Demodulator

Technical Specifications:

- Power supply : 230 V, 50 Hz
- Data Source**
- Data rate : 8 Kbps
- World Length : 8 bits
- Data Format : NRZ (Non Return to Zero)
- Clock Source : 8 KHz, 4 KHz
- Carrier Generators : 25 KHz (Sinusoidal)
- Pulse Shaping
- Waveform : 4 KHz
- Interconnections : 2 mm socket
- Power Supply : ± 5 V, ± 12 V DC, 200 mA
- Test Points : 36

Four Channel Analog TDM Trainer

Order Code - 40542



The Four channel analog TDM trainer demonstrate Time division multiplexing technique. The trainer provides all necessary inputs and connections for students to study amplitude modulation, demodulation, multiplexing and demultiplexing techniques. The trainer is student friendly & completely self contained, having all the basic required circuits and controls on board. Student troubleshooting work is included through switched faults in the trainer.

Features:

- 01. Self-contained trainer with built in power supply
- 02. On-board sine generator(synchronized)
- 03. On board DSB/DSBSC modulators
- 04. Crystal controlled carrier frequency generator
- 05. Four Analog input time multiplexed channels
- 06. Four Envelope detectors
- 07. On board four 4th order low pass filters
- 08. Input-output & test points provided on board
- 09. 8 Switched faults for fault simulation

Technical Specifications:

- Crystal frequency : 1 MHz
- On-board generators : Four Adjustable amplitude sine wave generators of 250 Hz, 500 Hz, 1 KHz and 2 KHz
- Input channels : Four
- Multiplexing : Time division multiplexing
- Modulation : DSB / DSBSC modulation
- On-board control signal frequency : 8 KHz, 16 KHz
- Test points : 29
- Interconnections : 2 mm sockets
- Power : 220 V ±10 %, 50 Hz / 60 Hz on request
- Power Consumption : 4.8 VA(approx.)
- Dimensions (mm) : W 340 × D 240 × H 105
- Weight : 1.8 Kg (approx.)
- Accessories : Manual, Set of patch cord, line cord

Experiments:

- 01. Study of DSB & DSBSC AM generation
- 02. Study of Time division multiplexing & demultiplexing of analog signals
- 03. Study of the effect of induced faults
- 04. Study of carrier frequency generation
- 05. Study of DSB & DSBSC AM reception & detection by Envelope detectors.

CDMA Trainer

Order Code - 40543



CDMA trainer provides a basic understanding of the concepts behind CDMA and various concepts needed to be considered in case of CDMA system design such as

pseudo random bit signal generation, the spreading and despreading of data sequence, Direct Sequence Spread Spectrum (DSSS) generation and decoding, digital modulation and demodulation for BPSK and PWM,

Technical Specification:

- * Power supply requirement 230VAC, 50Hz
- * In built regulated power supply
- * On board Digital Data signal generator to generate any binary input
- * Word length : 8 bit
- * Word clock frequency : 240 kHz
- * Data format NRZ (Non Return to Zero)
- * On board Pseudo Random Bit Signal generator to generate pseudo random bit sequence signal
- * Bit length : 15 bits
- * Direct sequence spread spectrum (DSSS) generator and decoder
- * On board analog signal generator variable upto 3.4kHz
- * Carrier generator : 1.44Mhz

Modulator:

- * Binary Phase Shift Keying Modulator
- * Pulse Width Modulator

Demodulator :

- * Binary Phase Shift Keying Demodulator
- * Pulse Width Demodulator
- * Power Supply : 220 V ±10 %, 50 Hz / 60 Hz on request
- * Power Consumption : 4 VA (approx.)

Experiments:

01. To study theory of CDMA DSSS modulation & Demodulation
02. To generate CDMA-DSSS signal
03. To demodulate CDMA-DSSS signal using BPSK
04. To study pseudo random bit sequence generation.

PC Based Logic Analyzer

Order Code - 40547



It is PC based 32 channel logic analyzer. It is a cost effective and versatile development cum debugging tool. This logic analyzer is very useful for educational institutions, industries and R & D labs. Works with host PC through high speed USB port and offers all the standard features and performance of the stand alone and expensive logic analyzers. Being a cost effective tool it also provides high speed clock rates, deep data buffers, sophisticated triggering, solid reliability etc.

Features :

01. High sampling (Up to 250M Sa/s)
02. 32 data input channels
03. Data buffer (up to 256K samples per channel)
04. High data bandwidth of 125MHz
05. Connects to Desktop PC or Notebook via USB Interface (Version 1.1/2.0)
06. No External Power Source Required
- 07 Supports Windows 98/ME, 2000 and XP operating Systems
08. Complex trigger, 2 level, 32 channel
09. User defined trigger position

10. High impedance probes minimize interference with the circuit under test
11. Captures both state and timing simultaneously with one probe
12. Adjustable threshold voltage suitable for ECL (-1.3V), LVC1.5V (0.75V), LVC1.8V (0.9V, LVC2.5V) (1.2V), LVC3.3V (1.4V), SSTL-2 2.5V (1.25V), SSTL2-2.5V(1.25V), SSTL3-3.3V (1.4V)
13. Expandable to 64 channels by cascading two units
14. Data exportable to windows excel or text format
15. Light weight & Compact size

Specifications:

- No of Channels : 32
- Sampling Rate : 32 channels from 1 Sa/s
- Memory (Channel record length) : 256K
- External Clock Rate : 125Msa/s
- Impedance : 250 kohm/2pF (tip to ground)
- Threshold Voltage : -2.00V to 1.9V by 25mV step
- PC interface : USB 1.1/2.0
- Maximum Input Voltage : -110V to +110V except EXT CLK. (0-5V)
- Channel Skew : Typical < 200Ps
- Trigger Position : Any user defined position
- Maximum Trigger speed: 250MHz (4ns)
- Trigger Quality : 0, 1, x (don't care) settings for al digital channels
- Capture Modes : Auto, Normal, Single

Experiments:

01. Main Logic Analyzer Unit
02. USB cable (A-Mini B)
03. Software CD
04. Easy Hook Clips 50 Nos
05. Two IDC 32 Pin connectors with PV wire
06. User's Manual

General

- 1. Current : 400mA approx

GSM Trainer

Order Code - 40548



The GSM Trainer is a modem or mobile equipment for transmission of voice and data calls as well as SMS (Short Message Service) in GSM Network. To control the GSM modem there is an advanced set of AT commands according to GSM ETSI (European Telecommunications Standards Institute) 07.07 and 07.05 implemented. The GSM standard has established itself across continents. The trainer is well suited for studying AT commands by camping to real networks using SIM card.

Features:

01. Low Cost
02. Simple / Easy Operation
03. Easy understanding of AT commands
04. Real Time operation
05. External Antenna

Technical Specifications:

GSM capability : GSM 900 / 1800, E - GSM
 GSM data services : Asynchronous, Transparent & Non Transparent modes. 14.4 kbits / s
 SIM Interface : 3 V

RF characteristics :

Receiver

EGSM Sensitivity : < -104 dBm
 DCS Sensitivity : < -102 dBm
 Selectivity @ 200 Khz : >+9 dBc
 Selectivity @ 400 KHz : >+41 dBc
 Dynamic range : 63 dB
 Intermodulation : >-43 dBm
 C-channel rejection : 9³ dBc

Transmitter

Maximum output power : 33 dBm ± 2 dB (EGSM)
 Maximum output power : 30 dBm ± 2 dB (DCS)
 Minimum output power : 5 dBm ± 5 dB (EGSM)
 Minimum output power : 0 dBm ± 5 dB (DCS 1800)
 Noise in 925 - 935 MHz : < -67 dBm
 Noise in 935 - 960 MHz : < -79 dBm
 Noise in 1805 - 1880 MHz : < -71 dBm
 Phase error at peak power : < 5° RMS
 Frequency error : ± 0,1ppm max
 Power supply : 9 V
 Current consumption : Max 500 mA

Experiments:

01. GSM Theory & Standards
02. Understanding of GSM technology, its network, GSM capability & data services.
03. Understanding RF environment & study of GSM network by actually connecting to the GSM environment by any service provider.
04. Command Level Study
05. Real Time study of GSM 07.05 & 07.07 commands in various
06. Categories :
 - Command concerning modem & sim card hardware
 - Network registration commands
 - Call control command
 - Call setting commands
 - Call information commands
 - Phone Book commands
 - Serial link control commands
 - Message setting commands
 - Storing/restoring commands
 - Error message handling & survey & many more....

Included Accessories:

01. Power adapter - 9 V / 500 mA
02. RS - 232 serial cable
03. GSM Antenna (900/1800) & cable (30cm) coaxial plug Handsfree kit
04. CD
05. Manual

Optional Application Module for Basic GSM Trainer

Order Code - 40549



GSM has achieved total global acceptance for its voice & data service. Further, capabilities of GSM/GPRS for supporting applications make it unique.
 What are AT commands?
 What can I do with them?

I'm unable to make out the response of AT commands? Tesca presents 40549 GSM application module a solution for all queries. It gives the AT command description, explanation for the response results of the AT commands & visualizations as well. It helps in understanding working fundamentals of GSM by camping to the real service provider network. It also demonstrates the application controlling appliances through SMS using AT commands. All bundled into one user friendly software tool "Sciinterminal" for easy understanding & functioning.

Features:

01. "Sciinterminal" software tool
02. Description / Explanation / Visualization of the AT commands on one screen
03. Study of GSM real time working fundamentals
04. Appliances switching by SMS using AT commands
05. Flow chart provided for further development
06. 2 Year Warranty

Experiments:

01. GSM Theory & Standards
02. Understanding of GSM technology, its network, GSM capability & data services.
03. Understanding RF environment & study of GSM network by actually connecting to the GSM environment by any service provider.
04. Command Level Study

Serial to Accessories:

- | | |
|-----------------------|---------|
| Parallel Cable | : 1 no. |
| Learning material CD | : 1 no. |
| Bulb 230VAC to 110VAC | : 1 no. |
| Patch cord (2mm) | : 1 no. |

Note: GSM Application 40549 can only used in combination with GSM platform 40548.

Data Communication Trainer

Order Code - 40554



Data Communications and Networking are one of the fastest growing segments today. The major reason for this growth is the dramatic increase in Networked offices, PC based products and internet users. More Students are taking courses to learn about them. Designed to assist students and practitioners to understand the various methods of exchange of data between two devices. It is designed to be user friendly and it supports self learning through the flexibility of making the connections by the user itself. For proper understanding of various protocols in serial and parallel communication, various experiments can be performed. In depth knowledge of ports and its functional details can be studied with the use of the

supporting software provided. Manuals and notes help the user to understand the major terminologies and theory related to Data Communication.

Features:

01. Pin to pin study of serial and parallel port
02. Different methods of serial communication
03. Different methods of parallel communication
04. Wireless communication (IR/RF)
05. Full duplex fiber optics communication
06. FSK modem communication
07. Software & hardware based data flow controls
08. Protocols of parallel port
09. Protocols of serial port
10. High speed data transmission
11. Visual indication by LED's for displaying data, status & control pins of port
12. Printer interface
13. Windows based operating software
14. Switch faults in both hardware & software
15. Exhaustive course material & references
16. Student friendly software
17. Optional application boards for serial and parallel port

Technical Specifications:

Serial Communication : Two RS-232 ports
 Parallel Communication : Two 25 pin LPT ports

Fiber Optic Communication

Transmitter : Two numbers. Fiber optic LED's having peak wave length of emission 660nm
 Receiver : Two numbers. Fiber optic photo detector
 Core type : Step indexed multimode PMMA plastic cable
 Baud rate : 115200 bps
 Fiber Length : 0.5 & 1m

Wireless Communication

Infrared Transmitter : IR LED
 Infrared Receiver : Direct TTL output
 Baud rate : 2400 bps
 Carrier Frequency : 38 KHz/40KHz

Modem Communication

Modem type : Data
 Interface type : Serial-RJ 11 Connector
 RJ 11 Connector : Two
 Modulation : FSK Modulation
 Mark Frequency : 340 KHz
 Space Frequency : 280 KHz
 Demodulation : PLL Detector
 Mark Frequency : 340 KHz
 Space Frequency : 280 KHz
 Baud Rate : 57600 bps

General

Power Supply : 220 V ±10%, 50 Hz / 60 Hz on request
 Power Consumption : 1.8 VA(approx.)
 Dimensions (mm) : W 370 × H 265 × D 125

Experiments:

01. To Study of Serial Port
02. Study of Parallel Port
03. Study of Synchronous Serial Communication
04. Study of Asynchronous Serial Communication
05. Study of PC-PC Serial Communication using RS-232 cable
06. Study of different Modem used in Serial

Communication

07. Study of Flow controls in Serial Communication
08. Study of Protocols in Serial Communication
09. Study of Fiber Optic Communication
10. Study of Modem Communication
11. Study of Wireless Communication
12. Study of PC-PC Parallel Communication using DB25 cable
13. Study of printer interface using parallel port

Accessories:

01. Two RS-232 Serial Cable
02. Two DB25 Parallel Port cable
03. One RJ11 RJ11 Connector Cable
04. Two Plastic Fiber Cable
05. Operating Manual
06. Software CD
07. Patch Cords

Optional Accessories : Application boards for Serial and Parallel Port

Local Area Network (LAN) Trainer

Order Code - 40555



Local Area Network (LAN) Trainer provides the understanding of all the fundamentals of networking. It helps the user to gain knowledge regarding all network layers, cable designing and building of complete network of computers. The user can understand and actually implement various topologies using different standards given by IEEE. Actual connections can be made in different topologies and data can be transferred. The user will understand the protocols, topologies used in networking, measurement of error rate, throughput and effect of errors on protocols. The versatile software provided with assist the user to observe the various effects and configurations on network along with the graphical representation.

Features:

01. PC to PC communication with IEEE 802.3
02. Peer to Peer network
03. Client - Server network
04. Design of Star topology using 100Base-Tx
05. Design of Bus topology using 10Base-2
06. Design of Ring topology using DB9
07. Creation of cables for network connections
08. Network design using RJ45, BNC & DB9 connectors
09. Socket programming and processing
10. Data Encryption and Decryption
11. Various LAN Protocols
12. Data rate up to 100Mbps
13. Variable packet size
14. Variable packet delay
15. Error generation (Manual and Auto)
16. Real time graphical representation of entire transmission & reception
17. User friendly software
18. Switch faults in both hardware & software
19. Exhaustive course material & references.

Technical Specifications:

Hardware:

- * PC to PC using RJ-45 Connector

- * Star topology using RJ45 Connector
- * Bus topology using BNC Connector
- * Ring topology using DB9 Connector
- * Data transmission speed: 10/100 Mbps
- * 4 Nodes

Software:

- * Star, Bus & Ring selection
- * Protocols: CSMA/CD, CSMA/CA, Stop N Wait, Go back to N, Selective repeat, Sliding Window, Token Bus, Token Ring
- * Packet size: 128, 256, 512, 1024, 2048, 4096, 8192, 16384
- * Inter Packet delay: 1000 - 5000 ms
- * Error generation: Acknowledgment lost, bad packet, auto error generation
- * Data encryption & decryption
- * Complete analysis of Network & Protocols

Graphical Representation:

- * Graphic representation of data on s/w screen with packet details

Network details:

- * Indication of computer name, IP address, Port number, status of network, MAC address and OS on computer.
- * Network & protocol analysis :
- * Indication of packet serial number, file name, file size, file number, receiver name, Workgroup ,receiver IP address , total packets, packet length, time out, protocol, topology, receiver, MAC address, port number, file send start time, file sent completion time, transmission time data rate(Mbps), error.
- * Power Supply : 220 V ±10%, 50 Hz / 60 Hz on request
- * Power Consumption : 1.8 VA (approx.)
- * Dimensions (mm) : W 370 × H 265 × D 125

Experiments:

01. Study & implementation of cable designs in networking
02. Implementation of PC to PC with IEEE 802.3
03. Implementation of Star topology using 100BaseTx
04. Implementation of Bus topology using 10Base2
05. Implementation of Ring topology using DB9
06. Implementation of Peer to Peer network
07. Implementation of Client- Server network
08. Study of protocols
09. CSMA/CD, CSMA/CA
10. Study of flow control
11. Stop-N-wait | Sliding window
12. Go back to N | Selective repeat
13. Token ring
14. Token bus
15. Measurement of throughput & effect of bit errors on various protocols
16. Socket programming
17. Study of wireless LAN

Audio Input Module

Order Code - 40556



LAN trainer is a versatile desktop system that provides hands on experimentation & understanding of local

area Networks. The field being diverse, this trainer has been designed with an aim to touch upon the various aspects of LAN's such as hardware & cabling, software configuration & protocols. The LAN trainer is supplemented by a set of 4 exhaustive manuals covering the various aspects of LAN's. The unique feature of this trainer is an onboard Hub & Cabling setup via jumpers so as to minimize the loss of expensive cable during training.

Object: - Study of LAN (Local Area Network)

Features:

01. Three sets of onboard cabling setup for Ethernet.
02. On board parallel port direct cable connection setup.
03. On board serial port direct cable connection setup.
04. A 10 mbps hub is provided onboard with the circuitry exposed.
05. The power supply circuit for Hub is provided onboard.
06. A separate Hub is also provides so to train students for multi Hub Networking.
07. A set of 4 exhaustive manuals covering LAN hardware & cabling, software configurations protocols, terms & definitions.
08. The trainer comes with a cable fabrication kit to provide hands on experience on real cabling.

Specification:

Lan Hardware

01. 10/100 Mbps Ethernet Card : 3 Nos.
02. UPT Straight cable with Connectors : 5 mtr.x 3 + ½ mtr.x3
03. Coaxial Cable with connectors and termination : 10 mtr.
04. Traight Parallel port cables : 2 Nos.
05. Straight Serial port cables : 2 Nos.
06. 10 Mbps 8 port Hub. : 2 Nos.
07. Set of patch cords for the Onboard cabling setup
08. Cable fabrication kit. : 8 RJ 45 male connectors, crimping tool & 10 mtr. UTP cables

Training Packages And Experiments

(a) Lan Hardware And Cabling

01. Setup a network between 2-8 Computers using Hub and straight cables (WIN XP)
02. Setup a network between two Computers without using Hub by using Cross cables (WIN XP)
03. Multi Hub Networking (WIN XP)
04. Setup a networking between Two computers using parallel port direct cable connection.
05. Setup a networking between two computers using serial port direct cable Connection.

(b) Software Configuration

01. Networking Win9x (Adding a Network Adapter)
02. Setting up a Win9x Peer to Peer Network
03. Windows XP Peer-to-Peer Networking
04. Sharing Local Resources
05. Adding Local or Network Printers
06. Adding a Network Printer With Windows XP
07. Adding Workstation Print Drivers for Windows 2000 Printers
08. Adding NT4 Workstation Print Drivers for Windows 2000 Printers

09. Adding a Windows2000 Workstation to a NT4 Domain
10. Configuring Dial-Up Internet Access with Windows9x (Adding the Dial-Up Adapter)
11. Windows2000 Dial-Up Internet Connection
12. Dial-Up Server (Installing and Configuring Dial-Up Server)
13. Windows2000 Networking Changes
14. WindowsXP Remote Assistance
15. WindowsXP Remote Desktop
16. Sharing a Fax/Modem on a Network
17. Configuring a machine running Window 95/98/ME to use DHCP.
18. Configuring a machine running Windows 2000 Professional Edition to use DHCP.
19. Configuring a machine running Windows NT 4.0 to use DHCP.
20. Configuring a machine running Windows XP to use DHCP.
21. Setting up and Configuring IIS
22. Configuring a Windows 2000 VPN Server
23. Windows2003 VPN Server
24. WindowsXP VPN Server
25. Windows98 VPN Client
26. WindowsXP VPN Client
27. DNS Concept
28. How DNS Works
29. Various DNS Configuration
30. How Reverse - Lock up works
31. DNS Terms.
32. Third Level Domains
33. Setting up MS DNS
34. MS DNS and Forwards
35. MS DNS Server as a Secondary
36. Client Side Caching (Offline Files)
37. Troubleshooting Internet
38. Troubleshooting TCP / IP Networks
39. Network Commands

(c) Study Manual

01. Communicaton and Network Concepts
 - a). Introduction
 - b). What is a Network
 - c). Need for Networking
 - d). Evolution of Networking
 - e). Switching Techniques
 - f). Transmission Media
 - g). Data Communication Technologies
 - h). Types of Networks
 - i). Network Topologies
 - j). Network Devices
 - k). Communication Protocol
 - l). Wireless/ Mobile Computing
 - m). Internetworking Terms and Concept
 - N). Network Security
02. The TCP/IP and OSI Networking Models
03. Data Link Layer Fundamentals : Ethernet LAN's
04. Fundamentals of WAN's
05. Fundamentals of IP
06. Fundamentals of TCP and UDP
07. Virtual LAN's and Trunking
08. LAN Cabling,Standers,and Topologies
09. IP Addressing and Subnetting

(d) Study Manual

01. Network Topology
02. Network Hardware Connections

03. TCP/IP Ports and Addresses
04. Network Protocol Levels
05. IEEE 802 Standard
06. Network Categories
07. Network Devices
08. Address Resolution Protocol (ARP and RARP Address Translation)
09. Basic Addressing
10. Internet Protocol
11. Transmission Control Protocol
12. User Datagram Protocol
13. Internet Control Message Protocol
14. Network Cabling
15. Wireless Networking
16. Network WAN Connections
17. Ethernet
18. Token Ring
19. ARC net Network (Attached Resource Computer Network)
20. AppleTalk Network
21. FDDI (Fiber Distributed Data Interface)
22. IPX/SPX
23. NetBEUI
24. AppleTalk Protocols
25. System Network Architecture
26. Other Transport Protocols
27. Network Routing
28. More Complex Networking Routing
29. IP Masquerading
30. Firewalls
31. Domain Name Service (DNS)
32. Virtual Private Networking
33. DHCP
34. BOOTP
35. RPC and NFS
36. Internet Group Management Protocol
37. Dynamic Routing
38. Simple Mail Transfer Protocol (SMTP)
39. Simple Network Management Protocol
40. Network Services (Networking Services and Ports)
41. Wide Area Networks
42. Network Backup
43. Network Fault Tolerance
44. Network Trouble Shooting
45. Network Drivers
46. Network operating systems (NOS)
47. Network Applications
48. Network Terms

QPSK Modulation / Demodulation Trainer

Order Code - 40611



Features:

01. Clock Generator
 - Synchronous clock generator using IC 555
 - Frequency of square wave is 200 Khz.
02. Carrier Generator
 - Provides Four quadri-phase carrier output generated using IC 7490.
 - 100KHz (0°), 100KHz (90°), 100KHz (180°), 100KHz (270°)
03. Data Generator

- Synchronous data generator using IC 74165
 - Switch selectable simulated data stream.
 - Data stream generated at approx.1Kb/s rate.
04. On-board Block features
 - QPSK -modulator circuit.
 - QPSK -Demodulator.
 - Block Description Screen printed on glassy epoxy PCB
 05. Interconnections
 - All interconnections are made using 2mm banana Patch cords.
 06. Test points are provided to analyze signals at various points.
 07. All Ics are mounted on IC Sockets.
 08. Bare board Tested Glass Epoxy SMOBC PCB is used.
 09. In-Built Power Supply of $\pm 12V/250mA$ with Power ON indication
 10. Attractive enclosure.
 11. Set of 2mm Patch cords for interconnections.
 12. User's Manual with sample experimental Programs.

TDM Pulse Amplitude Modulation/Demodulation Trainer

Order Code - 40612



Order Code-40612 is a Digital Communication Trainer System to under stand various digital Modulation and Demodulation Techniques. Various functional block diagrams are provided on-board for Teaching/Training. This Kits provides with various Test Points to visualize the signals on Oscilloscopes.

Features:

01. On-board 250Hz, 500Hz,1KHz, 2KHz Sine-wave generator.
02. Sampling rate of 32 KHz/Channel.
03. Channel Identification Signal of 8 KHz.
04. 4 Nos. of Analog Input Channel for multiplexing & Demultiplexing.
05. Clock regeneration at receiver using PLL
06. On-board 4th order Butter-worth Low pass filter with cut off frequency of 3.4khz.
07. In-Built Power Supply

Specifications:

Sine Wave Generator

- Provides Sine waveform output of 250Hz, 500Hz, 1 KHz, and 2 KHz.
- Amplitude adjustments possible DC Source
- Separate DC source Available.
- Amplitude adjustments possible

Pulse Generator

- Sampling rate of 32 KHz/channel.
- 8KHz. Channel Identification Signal
- 6.144 MHz. Crystal Controlled Pulse Generator.

On-board features

- Four Analog Input Channels for Multiplexing/ Demultiplexing
- Clock regeneration at receiver using PLL.
- 4th order Butterworth Low pass filter with cut off

frequency of 3.4 KHz.

- Block Description Screen printed on glassy epoxy PCB

Interconnections

All interconnections are made using 2mm banana Patch cords.

- * Test points are provided to analyze signals at various points.
- * All ICS are mounted on IC Sockets.
- * Bare board Tested Glass Epoxy SMOBC PCB is used.
- * In-Built Power Supply of $+5V/1.5A$, $\pm 12V/250mA$ with Power ON indication
- * Attractive enclosure.
- * Set of 2mm Patch cords for interconnections.
- * User's Manual with sample experiments Programs. 315mm x 245mm x 105mm (L x W x H).
- * Weight 3 Kgs.

List Of Experiments:

01. Study of Time Division Multiplexing and Demultiplexing using Pulse Amplitude modulation and demodulation.
02. Study of TDM Pulse Amplitude modulation and demodulation With Channel Identification Information.
03. Study of TDM Pulse Amplitude modulation and demodulation using PLL method.

TDM Pulse Code Modulation Trainer

Order Code - 40613



Order Code-40613 is a Digital Communication Trainer System to under stand various digital Modulation and Demodulation Techniques. Various functional block diagrams are provided on-board for Teaching/Training. This Kits provides with various Test Points to visualize the signals on Oscilloscopes.

Features:

01. Internal 500Hz & 1KHz Sine-wave generator.
02. Two Nos. of variable Amplitude DC Level.
03. 2 Nos. of Analog Input Channels.
04. Error Check code option (None, Even, Odd, Hamming)
05. None, Even, Odd, Hamming Parity selections.
06. Pseudo random sync. code generation.
07. 2 Mode of Operation Fast (240 KHz/Channel approx.)&slow (1Hz./channel approx.)
08. In-Built Power Supply

Specifications:

Sine Wave Generator

- Provides Sine waveform output of 500Hz, 1KHz.
- Amplitude adjustments possible.

DC Source

- Two Nos. of variable DC source.
- Amplitude adjustments possibleGenerator.

Mode of Operation

- Fast (240 KHz/Channel approx)
- Slow (1Hz. /channel approx.)

On-board features

- Two Nos. of Input Channels.
- Pseudo random sync. Code generator for FRAME Synchronization.

- PLL for Bit synchronization.
- Block Description Screen printed on glassy epoxy PCB

Interconnections

- All interconnections are made using 2mm banana Patch cords.
- * Test points are provided to analyze signals at various points.
- * All ICS are mounted on IC Sockets.
- * Bare board Tested Glass Epoxy SMOBC PCB is used.
- * In-Built Power Supply of +5V/1.5A, ±12V/250mA with Power ON indication.
- * Attractive enclosure.
- * Set of 2mm Patch cords for interconnections.
- * User's Manual with sample experiments programs.
- * 315mm x 245mm x 105mm (L x W x H).
- * Weight 3 Kgs.

List of Experiments:

01. Study of Pulse Code Modulation.
02. To study the principles of Analog to Digital and Digital to Analog Conversion
03. Study of Pseudo Random Sequences
04. Study of Error Check Code Logic:
 - None Parity Coding.
 - Odd Parity Coding.
 - Even Parity Coding.
 - Hamming Coding.
05. Study of effect of faults in Modulation & Demodulation Techniques.

TDM Pulse Code Demodulation Trainer

Order Code - 40614



Order Code-40614 is a Digital Communication Trainer System to under stand various digital Modulation and Demodulation Techniques. Various functional block diagrams are provided on-board for Teaching/Training. This Kits provides with various Test Points to visualize the signals on Oscilloscopes.

Features:

01. Single Channel Serial Input.
02. Pulse Code Demodulation.
03. On-board 4th order Butter-worth Low pass filter with cut off frequency of 3.4khz
04. On - b o a r d PL L t e c h n i q u e f o r r e g e n e r a t i o n .
05. Error Check code option (None, Even, Odd, Hamming)
06. None, Even, Odd, Hamming Parity selections.
07. Pseudo random sync. code generation.
08. In-Built Power Supply

Specifications:

Input Channels

- 2 Channel Time Division Multiplexed Pulse Code Modulation Receiver.

Mode of Operation

- Fast (240 KHz/Channel approx)
- Slow (1Hz./channel approx.)

On-board features

- Pseudo random sync. Code generator for FRAME Synchronization.

On-board features

- Pseudo random sync. Code generator for FRAME Synchronization.
- Receiver clock generation using PLL.
- Error Detection of None, Even, Odd, Hamming.
- Error Correction using Hamming Code technique
- None, Even, Odd, Hamming Parity selections
- Two Nos. of 4th order Butterworth Low pass filter with cut off frequency of 3.4 KHz.
- Four Switched Faults for Fault Selection
- Block Description Screen printed on glassy epoxy PCB

Interconnections

- All interconnections are made using 2mm banana Patch cords.
- * Test points are provided to analyze signals at various points.
- * All ICS are mounted on IC Sockets.
- * Bare board Tested Glass Epoxy SMOBC PCB is used.
- * In-Built Power Supply of +5V/1.5A, ±12V/250mA with Power ON indication.
- * Attractive enclosure.
- * Set of 2mm Patch cords for interconnections.
- * User's Manual with sample experiments programs.
- * 315mm x 245mm x 105mm (L x W x H).
- * Weight 3 Kgs.

List of Experiments:

01. Study of Pulse Code Demodulation.
02. Study of Error Check Code Logic:
 - None Parity Coding.
 - Odd Parity Coding.
 - Even Parity Coding.
 - Hamming Coding.
03. Study of Synchronization techniques using PLL.
04. Study of effect of faults in Modulation & Demodulation Techniques.

TDM Pulse Code Modulation Trainer

Order Code - 40615



Order Code-40615 is a Digital Communication Trainer System to under stand various digital Modulation and Demodulation Techniques. Various functional block diagrams are provided on-board for Teaching/Training. This Kits provides with various Test Points to visualize the signals on Oscilloscopes.

Features:

01. On-board 250Hz, 500Hz, 1KHz, 2KHz Sine-wave generator.
02. Sampling rate of 8KHz, 16KHz, 32KHz, 64KHz.
03. On-board Compander & Expander.
04. On-board Gain integration setting.
05. On-board 4th order Butter-worth Low pass filter with cut off frequency of 3.4khz
06. In-Built Power Supply.

Specifications:

Sine Wave Generator

- Provides Sine waveform output of 250Hz, 500Hz, 1 KHz, and 2 KHz.
- Amplitude of 0 - 4Vp-p

- Amplitude adjustments possible.

Pulse Generator

- Switch selectable sampling clock of 8KHz, 16KHz, 32KHz, 64 KHz.
- Crystal Controlled Pulse Generator.

On-board features

- Unipolar to Bipolar, Integrator for Modulation & Demodulation.
- CVSD Modulator and demodulator.
- Input and Output buffer are provided.
- 2nd order Butter-worth Low pass filter with cut off frequency of 3.4 KHz.
- 4th order Butter-worth Low pass filter with cut off frequency of 3.4 KHz.
- Compander and Expander are provided.
- Block Description Screen printed on glassy epoxy PCB

Modulation Techniques

- Delta modulation & demodulation.
- Adaptive/CVSD modulation & demodulation.

Interconnections

- All interconnections are made using 2mm banana Patch cords.
- * Test points are provided to analyze signals at various points.
- * All ICS are mounted on IC Sockets.
- * Bare board Tested Glass Epoxy SMOBC PCB is used.
- * In-Built Power Supply of +5V/1.5A, ±12V/250mA with Power ON indication.
- * Attractive enclosure.
- * Set of 2mm Patch cords for interconnections.
- * User's Manual with sample experiments programs.
- * 315mm x 245mm x 105mm (L x W x H).
- * Weight 3 Kgs.

List Of Experiments:

01. Study of delta modulation and delta demodulation.
02. Study of Slope Overload and Increased Integration Gain in Delta Modulation.
03. Study of Adaptive Delta modulation and CVSD.
04. Study of companding systems.
05. Study Voice modulation and Demodulation (Delta) **OPTIONAL.**
06. Study Voice modulation and Demodulation (CVSD) **OPTIONAL.**
07. Study Voice modulation and Demodulation (Companding) **OPTIONAL.**

Data Conditioning Trainer

Order Code - 40616



Order Code- 40616 is a Digital Communication Trainer System to under stand various digital Modulation and Demodulation Techniques. Various functional block diagrams are provided on-board for Teaching/Training. This Kits provides with various Test Points to visualize the signals on Oscilloscopes.

Features:

01. On-board 1MHz (0°), 1MHz(180°), 2MHz(0°) Carrier Generator.
02. On-board Clock and Coding data

03. Data format of NRZ-L, NRZ-M, NRZ-S, URZ, AMI, BIO-L, BIO-M, BIO-S.
04. ASK, PSK, FSK Modulator.
05. On-board Unipolar to Bipolar and Bipolar to Unipolar conversion.
06. In-Built Power Supply

Specifications:

Carrier Generator

- Provides Carrier Sine wave output of 1MHz (0°), 1MHz(180°), 2MHz(0°).
- Amplitude of 0 - 4Vp-p

Data Generator

- On-board 8 bit Data Generator for simulation of data coding.

On-board features

- Carrier Modulation using ASK, PSK, FSK.
- Data formats of NRZ-L, NRZ-M, NRZ-S, URZ, Bi-phase-L, Bi-phase-M, Bi-phase-S, AMI.
- On board Carrier Modulation.
- On-board Data Simulator.
- On-board Uni-polar to Bipolar conversion.
- On-board Bipolar to Uni-polar conversion
- Block Description Screen printed on glassyepoxy PCB

Modulation Techniques

- ASK, FSK, PSK Modulation.

Interconnections

- All interconnections are made using 2mm banana Patch cords.
- * Test points are provided to analyze signals at various points.
- * All ICS are mounted on IC Sockets.
- * Bare board Tested Glass Epoxy SMOBC PCB is used.
- * In-Built Power Supply of +5V/1.5A, ±12V/250mA with Power ON indication.
- * Attractive enclosure.
- * Set of 2mm Patch cords for interconnections.
- * User's Manual with sample experiments programs.
- * 315mm x 245mm x 105mm (L x W x H).
- * Weight 3 Kgs.

List Of Experiments:

01. Study of Data Coding and Decoding Techniques for Nonreturn to Zero Format.
02. Study of Data Coding and Decoding Techniques for Phase Encoded Format.
03. Study of Data Coding and Decoding Techniques for Return to Zero Format and Multilevel binary format.
04. Study of Amplitude Shift Keying Modulation Techniques.
05. Study of Frequency Shift Keying Modulation Techniques.
06. Study of Phase Shift Keying Modulation Techniques.

Data Reconditioning Trainer

Order Code - 40617



Order Code- 40617 is a Digital Communication Trainer System to under stand various digital Modulation

and Demodulation Techniques. Various functional block diagrams are provided on-board for Teaching/Training. This Kits provides with various Test Points to visualize the signals on Oscilloscopes.

Features:

01. Data format of NRZ-L, NRZ-M, NRZ-S, URZ, AMI, BIO-L, BIO-M, BIO-S converted to NRZ-L.
02. ASK, PSK, FSK Demodulator.
03. In-Built Power Supply

Specifications:

- * Carrier Demodulation using ASK, PSK, FSK.
- * Data formats of NRZ-L, NRZ-M, NRZ-S, URZ, Bi-phase-L, Bi-phase-M, Bi-phase-S, AMI encoded to NRZ-L format.
- * Receiver Clock generated by PLL.
- * Carrier Demodulation done by:
 - Rectifier Diode for ASK.
 - PLL Detector for FSK.
 - Square Loop Detector for PSK.
- Block Description Screen printed on glassy epoxy PCB.
- * Demodulation Techniques:
 - ASK, FSK, PSK Demodulation.
- * Interconnections
 - All interconnections are made using 2mm banana Patch cords.
- * Test points are provided to analyze signals at various points.
- * All ICS are mounted on IC Sockets.
- * Bare board Tested Glass Epoxy SMOBC PCB is used.
- * In-Built Power Supply of +5V/1.5A, ±12V/250mA with Power ON indication.
- * Attractive enclosure.
- * Set of 2mm Patch cords for interconnections.
- * User's Manual with sample experiments programs.
- * 315mm x 245mm x 105mm (L x W x H).
- * Weight 3 Kgs.

List of Experiments:

01. Study of different Data formats to NRZ-L Format.
02. Study of Amplitude Shift Keying Demodulation Techniques.
03. Study of Frequency Shift Keying Demodulation Techniques.
04. Study of Phase Shift Keying Demodulation Techniques.

FDM Trainer

Order Code - 40618



Specifications:

Sine Wave Generator

- Two Nos. of Sine Wave generators Provided.
- Independent Switch selection of 10Hz, 100 Hz, 1 KHz, & 10 KHz.
- Provision for Amplitude adjustments provided.
- Provision for Frequency adjustments provided

Carrier Generator

- Fixed Sine Wave Generators of 100 KHz and 200 Khz.

On-board features

- Two Nos. of DSB-SC Modulator.
- Summing Amplifier provided.
- Two Nos. of Balanced De-modulator.
- Audio input & output amplifier.
- Two 2nd order Butterworth Low pass filter with cut off frequency of 10 Khz.
- Block Description Screen printed on glassy epoxy PCB

Interconnections

- All interconnections are made using 2mm banana Patch cords.
- * Test points are provided to analyze signals at various points.
- * All ICS are mounted on IC Sockets.
- * Bare board Tested Glass Epoxy SMOBC PCB is used.
- * In-Built Power Supply of +5V/1.5A, ±12V/250mA with Power ON indication
- * Attractive enclosure.
- * Set of 2mm Patch cords for interconnections.
- * User's Manual with sample experiments programs.

List of Experiments:

01. Study of Carrier Frequency Generation.
02. Study of DSBAM Generation Circuit.
03. Study of DSBAM Demodulation Circuit.
04. Study of Generation of Frequency Division Multiplexer signal.
05. Study of Generation of Frequency Division Demultiplexer signal

BPSK / DEPSK / DPSK Modulation / Demodulation Trainer

Order Code - 40619



Order Code-40619 is an Advance Digital Communication Trainer System that helps one understand various Digital Modulation and Demodulation Techniques. Various functional block diagrams are provided on-board as an aid for Teaching/Training. These Kits are provided with various Test Points to visualize the signals on Oscilloscopes.

Features:

01. Onboard synchronized 500 KHz Sine-wave generator.
02. Differential Encoding type Data Format.
03. On-board crystal controlled Pulse Generator.
04. On board 8 bit Data Simulator.
05. Block Description screen printed on PCB.
06. In-Built Power Supply

Specifications:

Carrier Sine Wave Generator

- Provides synchronized Sine waveform output of 500KHz(0 deg.), 500KHz(180 deg.)

Clock And Data Generator

- 8 bit variable NRZ-L pattern generated depending on the position of the 8-dit Data Switch provided.
- Clock Frequency is of 250 Khz.

Data Format (Coding)

- Non Return to Zero-Level (NRZ-L)
- Differential Encoded NRZ-L.

Carrier Modulation Techniques

- BPSK modulation
- DPSK modulation
- DEPSK modulation

On-board features

- Square Looping Technique used in Demodulation section
- Switch Faults are provided on board to study different effects on circuit
- Block Description Screen printed on glassy epoxy PCB

Interconnections

- All interconnections are made using 2mm banana Patch cords.

- * Test points are provided to analyze signals at various points.
- * All ICS are mounted on IC Sockets.
- * Bare board Tested Glass Epoxy SMOBC PCB is used.
- * In-Built Power Supply of +5V/1.5A, ±12V/250mA with Power ON indication
- * Attractive enclosure
- * Set of 2mm Patch cords for interconnections
- * User's Manual with sample experiments programs.

List of Experiments:

01. Principles of advance digital modulation techniques.
02. Differential Encoding of Data.
03. Binary Phase Shift Keying Modulation / Demodulation technique.
04. Differential Phase Shift Keying Modulation / Demodulation technique.
05. Differentially Encoded Phase Shift Keying
06. Modulation / Demodulation technique.
07. Effect of Switch Faults.

QPSK / DQPSK Modulation Trainer

Order Code - 40620



Order Code-40620 is an Advance Digital Communication Trainer System that helps one understand various Digital Modulation and Demodulation Techniques. Various functional block diagrams are provided on-board as an aid for Teaching/Training. These Kits are provided with various Test Points to visualize the signals on Oscilloscopes.

Features:

01. Onboard synchronized 500 KHz Sine-wave generator.
02. Dabit Pair, Differential Encoding type Data Format.
03. On-board crystal controlled Pulse Generator.
04. On board 8 bit Data Simulator.
05. Block Description screen printed on PCB.
06. In-Built Power Supply.

Specifications:

Sine Wave Generator

- Provides synchronized Sine waveform output of 500KHz (0 deg.), 500KHz(90 deg.), 500 KHz (180 deg.), 500KHz(270deg.)
- Amplitude of 0 - 4Vp-p
- Provision for Amplitude adjustments provided.

Data Format (Coding)

- Dabit Pair (I & Q), Differential Encoding of I & Q Bits.

Carrier Modulation Techniques

- DPSK modulation
- DQPSK modulation

Pulse Generator

- Clock frequency of 250 KHZ BIT, BIT Clock, Word Clock.
- Crystal Controlled Pulse Generator.

On-board features

- On board 8 bit variable NRZ-L pattern Data Simulator.
- Switch Faults are provided on board to study different effects on circuit
- Block Description Screen printed on glassy epoxy PCB

Interconnections

- All interconnections are made using 2mm banana Patch cords.

- * Test points are provided to analyze signals at various points.
- * All ICS are mounted on IC Sockets.
- * Bare board Tested Glass Epoxy SMOBC PCB is used.
- * In-Built Power Supply of +5V/1.5A, ±12V/250mA with Power ON indication
- * Attractive enclosure
- * Set of 2mm Patch cords for interconnections
- * User's Manual with sample experiments programs.

List of Experiments:

01. Principles of advance digital modulation and Demodulation techniques.
02. Dabit pair data coding technique of NRZ-L data format.
03. Differential Encoding of I & Q Bits.
04. Observation of constellation diagram.
05. Quadrature Phase Shift Keying Modulation and
06. Demodulation technique.
07. Differential Quadrature Phase Shift Keying Modulation and Demodulation technique.
08. Effect of Switch Faults.

QPSK / DQPSK Demodulation Trainer

Order Code - 40621



Order Code-40621 is an Advance Digital Communication Trainer System that helps one understand various Digital Modulation and Demodulation Techniques. Various functional block diagrams are provided on-board as an aid for Teaching/Training. These Kits are provided with various Test Points to visualize the signals on Oscilloscopes.

Features:

01. Dabit Pair, Differential Encoding type DataFormat for decoding.
02. Receiver Clock generated by PLL method.
03. Switch faults are provided to study its effects on circuits.
04. Block Description screen printed on PCB.
05. In-Built Power Supply.

Specifications:

Data Format (De-Coding)

- Dibit Pair (I & Q), Differential Encoding of I & Q Bits.

Carrier Demodulation Techniques

- DPSK Demodulation
- DQPSK Demodulation

On-board features

- Receiver Clock generated by PLL method
- Switch Faults are provided on board to study different effects on circuit
- Block Description Screen printed on glassy epoxy PCB

Interconnections

- All interconnections are made using 2mm banana Patch cords.
- * Test points are provided to analyze signals at various points.
- * All ICS are mounted on IC Sockets.
- * Bare board Tested Glass Epoxy SMOBC PCB is used.
- * In-Built Power Supply of +5V/1.5A, ±12V/250mA with Power ON indication
- * Attractive enclosure
- * Set of 2mm Patch cords for interconnections
- * User's Manual with sample experiments programs.

List of Experiments:

01. List of experiments are same for both 40620 and 40621.
02. 40620 and 40621 are combined to perform the experiments

Base Band Transmission/Reception Trainer

Order Code - 40622



Order Code-40622 is an Advance Digital Communication Trainer System that helps one understand various Digital Modulation and Demodulation Techniques. Various functional block diagrams are provided on-board as an aid for Teaching/Training. These Kits are provided with various Test Points to visualize the signals on Oscilloscopes.

Features:

01. The board consists of the following built-in parts :
02. On-board Noise Generator.
03. On-board PRBS Generator.
04. On-board Bit Error Rate Meter.
05. Switch faults are provided to study its effects on circuits
06. Block Description screen printed on PCB
07. In-Built Power Supply

Specifications:

Noise Generator

- Provides White Noise Source output
- Amplitude of 0 - 4Vp-p
- Provision for Amplitude adjustments provided.

PRBS Generator

- 16 Bit switch selectable
- Jumper selectable clock rate of 16, 32, 64, 128, 256, 512KHz, and 1.024

BIT ERROR RATE Meter

- Four digit counter displayed on seven segment

- Four digit seven segment counting up to 9999
- LED for terminal count indication provided

Digital Modulation Technique

- Pulse Amplitude Modulation technique is used
- Internal sampling clock: of 16 KHz to 1MHz
- 50 % duty cycle

Coding Operation

- 16 bit data pattern for scrambler
- 16 bit data pattern for unscrambler

On-board features

- Switch Selectable first order Butterworth Transmitter filter (Five Bands)
- Switch Selectable first order Butterworth Receiver filter (Five Bands)
- Switch Faults are provided on board to study different effects on circuit
- Block Description Screen printed on glassy epoxy PCB

Interconnections

- All interconnections are made using 2mm banana Patch cords.
- * Test points are provided to analyze signals at various points.
- * All ICS are mounted on IC Sockets.
- * Bare board Tested Glass Epoxy SMOBC PCB is used.
- * In-Built Power Supply of +5V/1.5A, ±12V/250mA with Power ON indication
- * Attractive enclosure
- * Set of 2mm Patch cords for interconnections
- * User's Manual with sample experiments

List of Experiments:

01. Study of pulse amplitude modulation of digital datas for base band transmission.
02. Study of data extraction and recovery in base band digital transmission.
03. Study of transmission and reception of band limited pulse train in base band digital transmission system.
04. Study of eye pattern.
05. Observation and calculation of noise margin percentage.
06. Measurement of bit error rate using binary data.
07. Study of message Scramblers and Unscramblers.
08. Effect of Switch Faults.

QAM / DQAM Modulation Trainer

Order Code - 40623



Order Code-40623 is an Advance Digital Communication Trainer System that helps one understand various Digital Modulation and Demodulation Techniques. Various functional block diagrams are provided on-board as an aid for Teaching/Training. These Kits are provided with various Test Points to visualize the signals on Oscilloscopes.

Features:

01. On-board Sine-wave generator.
02. On-board Four Carrier Sine waves of 500Khz.
03. On board three nos. of 8-bit NRZ-L. Data Simulator.
04. Clock frequency of 250 Hz.
05. Dat Format (Coding) is NRZ-L, Tribit encoded and

06. Differential Encoded I & Q bits.
07. In-Built Power Supply.

Specifications:

Carrier Sine Wave Generator

- Four carrier sine waves Generated onboard.
- Provides synchronized Sine waveform output of 500KHz(0deg.),500KHz(90 deg.),500KHz(180 deg.),500KHz(270 Deg.).

Clock And Data Generator

- 24 bit variable NRZ-L pattern generated depending on the position of the three nos. of 8-bit Data Switch provided.
- Clock Frequency is of 250 Khz.

Data Format (Coding)

- Non Return to Zero-Level (NRZ-L)
- Tribit encoded data (I, Q & C)
- Differentially Encoded I & Q Bits.

Carrier Modulation Techniques

- Quadrature Amplitude Modulation.
- Differentially Quadrature Amplitude Modulation.

On-board features

- On board Three Nos. Of 8 bit variable NRZ-L pattern Data Simulator
- Switch Faults are provided on board to study different effects on circuit.
- Block Description Screen printed on glassy epoxy PCB.

Interconnections

- All interconnections are made using 2mm banana Patch cords.
- * Test points are provided to analyze signals at various points.
- * All ICS are mounted on IC Sockets.
- * Bare board Tested Glass Epoxy SMOBC PCB is used.
- * In-Built Power Supply of +5V/1.5A, ±12V/250mA with Power ON indication
- * Attractive enclosure
- * Set of 2mm Patch cords for interconnections
- * User's Manual with sample experiments programs

List of Experiments:

01. To study the elements of 8-QAM / DQAM system.
02. Tribit coding technique of NRZ-L data format.
03. Differential Encoding of Data.
04. 8-QAM Modulation technique.
05. DQAM Modulation technique.
06. To study of constellation Diagram of QAM.
07. To study bandwidth efficiency in QAM techniques.
08. Effect of Switch faults.

QAM/DQAM Demodulation Trainer

Order Code - 40624



Order Code-40624 is an Advance Digital Communication Trainer System that helps one understand various Digital Modulation and Demodulation Techniques. Various functional block diagrams are provided on-board as an aid for Teaching/Training. These Kits are provided with various Test Points to visualize the signals on Oscilloscopes.

Features:

01. Receiver Clock generated by PLL method.
02. Demodulation is done using PLL and Envelop Detector Method.
03. Switch faults are provided to study its effects on circuits.
04. Block Description screen printed on PCB.
05. In-Built Power Supply.

Specifications:

Receiver Clock

- Receiver clock generated using PLL method

Data Format (Decoding)

- Non Return to Zero-Level (NRZ-L)
- Tribit Decoded data (I, Q & C)
- Differentially Decoded I & Q Bits.

Carrier Demodulation Techniques

- Quadrature Amplitude Demodulation
- Differentially Quadrature Amplitude Demodulation

On-board features

- QAM/DQAM Demodulation using PLL and Envelop detectors
- Switch Faults are provided on board to study different effects on circuit
- Block Description Screen printed on glassy epoxy PCB

Interconnections

- All interconnections are made using 2mm banana Patch cords.
- * Test points are provided to analyze signals at various points.
- * All ICS are mounted on IC Sockets.
- * Bare board Tested Glass Epoxy SMOBC PCB is used.
- * In-Built Power Supply of +5V/1.5A, ±12V/250mA with Power ON indication
- * Attractive enclosure.
- * Set of 2mm Patch cords for interconnections.
- * User's Manual with sample experiments programs.

List of Experiments:

01. To study Tribit decoding technique.
02. To study Differential decoding of Data.
03. Observation of constellation diagram.
04. To study bandwidth efficiency of 8-QAM/DAQM.
05. To study 8-QAM Demodulation technique.
06. To study DQAM Demodulation technique.
07. To study Effect of Switch faults.

DPCM/ADPCM Modulation/Demodulation Trainer

Order Code - 40625



Order Code-40625 is an Advance Digital Communication Trainer System that helps one understand various Digital Modulation and Demodulation Techniques. Various functional block diagrams are provided on-board as an aid for Teaching/Training. These Kits are provided with various Test Points to visualize the signals on Oscilloscopes.

Features:

01. Receiver Clock generated by PLL method.

02. Demodulation is done using PLL and Envelop Detector Method.
03. Switch faults are provided to study its effects on circuits.
04. Block Description screen printed on PCB.
05. In-Built Power Supply.

Specifications:

Sine Wave Generator

- Provides Sine waveform output using IC 74164.
- Frequency of Sine wave is 500 Hz with variable Amplitude of max.0-4Vp-p

Data Clock Generator

- Jumper selectable clock with amplitude of 5V.
- Clock of frequencies 64 KHz, 128 KHz, 256 KHz and 512KHz.

Sampling Clock

- Sampling Clock is generated using IC 4016.
- Sampling Clock Frequency of 16 KHz and Amplitude of 5V.

On-board features

- DPCM modulation using sampler, quantizer and linear predictor.
- Onboard Buffer is provided using Lf353.
- DPCM demodulation using linear predictor, Integrator and Low pass Filter.
- On-board Low pass filter using TI084.
- Block Description Screen printed on glassy epoxy PCB.

Interconnections

- All interconnections are made using 2mm banana Patch cords.
- * Test points are provided to analyze signals at various points.
- * All ICS are mounted on IC Sockets.
- * Bare board Tested Glass Epoxy SMOBC PCB is used.
- * In-Built Power Supply of +5V/150mA, ±12V/250mA with Power ON indication
- * Attractive enclosure.
- * Set of 2mm Patch cords for interconnections.
- * User's Manual with sample experiments programs.

MSK Modulation / Demodulation Trainer

Order Code - 40626



Specifications:

Carrier Generator

- On Board synchronized RF carrier signal generators with frequencies of 120 KHz, 200 KHz

Data Generator

- 8 bit Digital Data generator to generate any binary input word.
- Selection of Data using 8-way DIP Switch.

Display

- One LED indicator to indicate Power input.

On-board Circuits

- On board two Balanced Modulator Circuit.
- Demodulator PLL Detector Circuit.
- Squarer Circuit

Power Supply

- Fixed DC power supply : + 5 V/500mA
- Fixed DC power supply : +/-12 V/500mA

Interconnections

- All interconnections are made using 2mm banana Patch cords.
- * Bare board Tested Glass Epoxy PCB is used.
- * Set of 2mm Patch cords for interconnections.
- * User's Manual.

CRC Code / Decode Trainer

Order Code - 40627



Specifications:

Pulse Generator

- One Switch to provide Low to High Pulse.
- One Switch to provide High to Low Pulse.

Data Generator

- 8 bit Digital Data generator to generate any binary input word.
- Selection of Data using 8-way DIP Switch.

Display

- One LED indicator to indicate Power input.

On-board Circuits

- CRC Encoder/ Transmitter Circuit for 16 bits CRC Polynomials
- CRC Decoder/ Receiver Circuit for 16 bits CRC Polynomials.
- Data Receiver Circuit for 8 Data bits.

Power Supply

- Fixed DC power supply : + 5 V/500mA

Interconnections

- All interconnections are made using 2mm banana Patch cords.
- * Bare board Tested Glass Epoxy PCB is used.
- * Set of 2mm Patch cords for interconnections.
- * User's Manual.

Data Communication Trainer

Order Code - 40628



Specifications:

Serial Communication : RS-232 port (9 pin & 25 pin)

Parallel Communication : 25 Pin LPT Port.

Wire Less Communication

- Infrared Transmitter: IR LED 920nm
- Infrared Receiver: Direct TTL output
- Baud Rate: 2.4kbps (max)
- Carrier Frequency: 38KHz

Optic Fiber Communication

- Transmitter: Peak wavelength of emission 660nm visible Red
- Receiver: Photo detector with TTL Logic output.
- Baud Rate: 115kbps.

Fiber Optic Cable

- Type: Plastic Fiber, Step Index, Multimode
- Length: 1 meter

Modem Communication

- Modulation: FSK Modulation
- Mark Frequency: 300KHz

- Space Frequency: 200KHz
- Demodulation: PLL Detector
- Mark Frequency: 300KHz
- Space Frequency: 200KHz
- Baud Rate: 19.2kbps (max)
- Twisted Pair Link: RJ 11 Telephone Connector
- Data Indication: 8 bit Received Data Display.

Switch Faults

- 4 Switch Faults are provided on-board to study different effects on circuit.
- * 2mm Banana Socket for interconnection.
- * 20 Nos. of Test Points are provided on board to observe various intermediate signals.
- * In-Built Power Supply +5V, ±12V

List of Experiments:

01. Study of Serial and Parallel Port.
02. Study of Serial Communication.
03. Study of flow controls in Serial Communication.
04. Study of Protocols in Serial Communication.
05. Study of Fiber optic Communication.
06. Study of Modem Communication.
07. Study of Wire less Communication.
- 08 Study of Parallel Communication.
09. Study of Printer Interface using Parallel Port.

Accessories:

- * Blue Short Links (10"): 8 Nos.
- * RS-232 Serial Cable: 02 Nos.
- * DB25 Parallel Port Cable: 2 Nos.
- * RJ11-RJ11 Connector Cable : 02 Nos.
- * Plastic Fiber Cable Multimode: 01 Meter.
- * Experimental Manual: 01 No.
- * Power Supply Cable: 01 No.

GPS Trainer Kit

Order Code - 40628A



A GPS tracking unit is a device that uses the Global Positioning System to determine the precise location of a vehicle, person, or other asset to which it is attached and to record the position of the asset at regular intervals. A GPS tracker essentially contains GPS module to receive the GPS signal and calculate the coordinates.

Specifications:

- * L1 Frequency, C/A code, 51-channel High Sensitivity : Up to -158 dBm tracking, superior urban performances
- * Position Accuracy : < 3m CEP (50%) without SA (horizontal)
- * Cold Start is Under 36 seconds (Typical)
- * Warm Start is Under 34 seconds (Typical)
- * Hot Start is Under 1 second (Typical)
- * Max. Update Rate : 5Hz (Default: 1 Hz)
- * Pin header Connection for easy to assemble.
- * Low Power Consumption : 55mA @ acquisition, 40mA@ tracking
- * 9600 baud rate Serial Transmission
- * Built in RS232 Level Converter (MAX232) provided in 9 Pin D type connector.
- * Windows based software support GPS Status,

- Signal Level, Sky chart constellation of SV,
- * All interconnections are made using 2mm banana Patch cords.
- * Test points are provided to analyze signals at various points.
- * All ICS are mounted on IC Sockets.
- * Bare board Tested Glass Epoxy SMOBC PCB is used.
- * In-Built Power Supply of +3.3V/1A with Power ON indication.
- * Attractive ABS Plastic Enclosure.
- * Set of 2mm Patch cords for interconnections
- * Normal operation temperature: -20°C to +55°C.
- * Input Voltage: 230VAC.
- * User's Manual

List of Experiments:

01. Introduction to GPS, software installation.
02. Getting started with GPS training system.
03. Satellite signal strength indication using SNR plot.
04. Study of satellite azimuth and elevation window using sky plot.
05. Geographical location with (GMT/IST) with navigation window.
06. To study geographical position using survey plotting.
07. Study of NEMA received sentences using trace window.

GSM Trainer

Order Code - 40629



The GSM Trainer is a modem or mobile equipment for transmission of voice and data calls as well as SMS (Short Message Service) in GSM Network. To control the GSM modem there is an advanced set of AT commands according to GSM European Telecommunications Standards Institute implemented. The GSM standard has established itself across continents. The trainer is well suited for studying AT commands by camping to real networks using SIM card.

Specifications:

- * Quad-Band GSM/GPRS 850/ 900/ 1800/1900 MHZ.
- * Built in RS232 Level Converter (MAX232) provided in 9 Pin D type connector.
- * Configurable baud rate.
- * SMA connector with GSM LType Antenna.
- * Built in SIM Card holder.
- * Built in Network LED, Status LED, Power LED.
- * Inbuilt Powerful TCP/IP protocol stack for internet data transfer over GPRS.
- * Audio interface Connector.
- * AT cellular command interface through Windows based Hyperterm Software.
- * All interconnections are made using 2mm banana Patch cords.
- * Test points are provided to analyze signals at various points.
- * All ICS are mounted on IC Sockets.
- * Bare board Tested Glass Epoxy SMOBC PCB is used.
- * In-Built Power Supply of +9V/1.5A.

- * Attractive ABS Plastic Enclosure.
- * Set of 2mm Patch cords for interconnections.
- * Normal operation temperature: -20 °C to +55 °C
- * Input Voltage: 230V AC.
- * User's Manual .

List of Experiments:

01. Study of GSM technology.
02. Getting started with GSM trainer.
03. Study of GSM MODEM and it's components.
04. Study of SIM.
05. Introduction to AT commands.
06. Voice communication using AT commands.
07. Data communication using AT commands.
08. Sending text message using AT Commands.

ASK, FSK, BPSK, Dbpsk Modulator and Demodulator

Order Code - 40630



Order Code - 40630 are compact and user friendly learning platforms to provide a modern, portable, comprehensive and practical way to learn Technology. Each 40630 provided with detailed Multimedia learning material which covers basic theory, step by step procedure to conduct the experiment and other useful information.

Order Code - 40630 provides an extensive hands on ASK, FSK, BPSK, DBPSK Modulator & Demodulator.

Object:

01. Amplitude Shift Keying Modulation & Demodulation Objectives:
 - Study and analysis of Amplitude Shift Keying Modulation
 - Study and analysis of Amplitude Shift Keying Demodulation.
 - Study and analysis of Integrator and Comparator block
02. Frequency Shift Keying Modulation & Demodulation Objectives:
 - Study and analysis of Frequency Shift Keying Modulation
 - Study and analysis of Frequency Shift Keying Demodulation.
 - Study and analysis of Integrator and Comparator block.
03. Binary Phase Shift Keying Modulation & Demodulation Objectives:
 - Study and analysis of Binary Phase Shift Keying Modulation .
 - Study and analysis of Binary Phase Shift Keying Demodulation.
 - Study and analysis of Integrator and Comparator block .
04. Differential Binary Phase Shift Keying Modulation & Demodulation Objectives:
 - Study and analysis of Differential encoder and decoder.
 - Study and analysis of Differential Binary Phase Shift Keying Modulation .
 - Study and analysis of Differential Binary Phase

Shift Keying Demodulation.

Features:

01. Personalized Learning platform
02. On-board Data Generator with various data patterns
03. Selectable data frequencies and data patterns

Technical Specification:

01. Modulation & Demodulation Techniques : ASK, FSK, BPSK, DBPSK
02. Internal Data Generator : Digital data (PNS)
03. Data Pattern : 8-Bit, 16-Bit, 32-Bit, 64-Bit
04. Frequency : 2KHz, 4KHz, 16KHz
05. Internal Carrier Generator : Direct Digital Synthesized
06. Carrier Signal : Sine
07. Number of Test Points : 39 nos.
08. Crystal Frequency : 4.096MHz
09. Selection Mode : atch cords
10. Operating Condition : 0-400 C, 85% RH
11. Power Supply : 230V AC, 50Hz
12. Weight : 4.5 Kg (approx)
13. Dimensions (mm) : W415xD165xH315

List Of Accessories:

- 01 Patch cord 2mm length 50cm. Red.....04
- 02 Patch cord 2mm length 50cm. Black.....03

16 Bit PCI DAS Card

Order Code - 40631



The 40631 is a high performance multifunction card providing high-speed analog I/O and digital I/O functions. The 40631 card has a universal PCI interface supporting both 3.3 V and 5 V PCI bus. This card features a continuous, 250 k Samples/Sec 16-bit resolution A/D converter, 8 K samples hardware FIFO, 2-ch 16-bit D/A converter, 32-ch programmable digital I/O and DO read back. The 40631 provides either 32-ch single-ended or 16-ch differential analog inputs which are jumper selectable. The 40631 is equipped with a high speed PGA featuring programmable gain controls (1, 2, 4, 8).

The 40631 has the Card ID switch and pull-high/pull-low resistors for DI on board. Users can set Card ID on a board and recognize the board by the ID via software when using two or more 40631 cards in one computer. The pull-high/pull-low resistors allow specifying the DI status; when the DI channels are unconnected, the DI status will remain in high or low status other than floating.

The 40631 provides two programmable trigger methods: software trigger and pacer trigger. The A/D channel scan function of 40631 is so amazing, we call it MagicScan. The MagicScan controller takes out most works of getting A/D value such as select channel, set gain, settling time, trigger ADC and get data. With the built-in MagicScan and interrupt features, it is effectively off-loading your CPU from the job. Even in channel scan mode, it can have different gain code for each channel, and the sampling rate can still reach 250 kS/s totally. The 40631 is suitable for high end

applications.

Specification:

Analog Output

Channels : 32 single-ended/16 differential
 AD Conversion : 16-bit,4ms conversion time
 Sampling Rate : 250 kS/s. max.
 FIFO Size : 8192 samples Over voltage Protection : Continuous +/-35 Vp-p
 Input Impedance : 10,000 MW/4pF
 Trigger Modes : Software, Pacer
 Data Transfer : Polling, Interrupt
 Accuracy : 0.05% of FSR ±1 LSB @ 25°C, ±10V
 Zero Drift : 15ppm/°C of FSR

Analog Output

Channels : 2
 Resolution : 16-bit
 Accuracy : ±6LSB
 Output Range : -5V~5V, -10V~10V, 0~10V, 0~5V
 Output Driving : +/- 5 mA
 Slew Rate : 8.33 V/ms
 Output Impedance: 0.1 W max.
 Operating Mode : Software

Programmable I/O

Channels : 32

Digital Input

Compatibility : 5 V/TTL
 Input Voltage : Logic 0: 0.8 V max.
 Logic 1: 2.0 V min.

Pull High/Pull Low : Yes

Response Speed : 1.0 MHz (Typical)

Digital Output

Compatibility : 5 V/TTL
 Output Voltage : Logic 0: 0.4 V (max.)
 Logic 1: 2.4 V (min.)

Output Capability : Sink: 40 mA
 Source: 20 mA

DO Read Back : Yes

Response Speed : 1.0 MHz (Typical)

General

Bus Type : 3.3 V/5 V Universal PCI, 32-bit

Data Bus : 16-bit

Card ID : Yes(4-bit)

I/O Connector : Female DB37 x 1
 20-pin box header x 2
 Dimensions (L x W x D)
 : 170mm x 150mm x 22mm

Power Consumption : 1 A @ +5 V max.

Operating Temperature : 0~60°C

Storage Temperature : -20 ~ 70 °C

Humidity : 5 ~ 85% RH, non-condensing

16 Channel Relay Output Board

Order Code - 40632



The 40632 16 channel Relay Output Board consists of 16 form c relays for efficient switch of load by programmed control. It is connector and functionally compatible with 785 series board but with industrial

type terminal block. The 40632 can be used by 812 board or any other compatible board The relay are energized by apply 5 volt signal to the appropriate relay channel on the 20-pin flat cable connector . Sixteen enunciator LEDs ,one for each relay , light when their associated relay is activated . To avoid overloading your PC's power supply ,this board provides a screw terminal for power supply .

Specifications:

Built-in signal and power sources

FORM C RELAY

Type : SPDT(form C)

Maximum input voltage : 24 VDC or 24 VAC

Nominal load : 0.5 A /120 VAC , 1A /24 Vdc

Max. Switching power : 60VA,24W

Max. Switching Voltage : 120VAC,60Vdc

Max. Switching Current : 1A

Life Expectancy : Mechanical (2x10),
 Electrical (2 x 10)

Release Time Value : Operate (6 ms)

Control Logic : Input TTL high (+5V) , relay on

Power Consumption : +12V @528mA max.
 +5V @150mAmAmax.

Dimension : 205mm X 114mm

Operating Temperature : 0 -60°C

Storage Temperature : -20~70°C

Humidity : 5% to 90 % non condensing

16 Channel Multiplexer Board

Order Code - 40633



The 40633 is an expansion multiplexer/ amplifier board for use with 82X, 1800 series 818 families. Each 40633 multiplexes 16 differential analog input channels into one analog input of the DAS board. The high grade instrumentation provides software programmable gains of 0.5 ,1,5 ,10,50, 100, 500,and 1000. Thermocouple measurement are handled easily with 40633. The board includes cold-junction sensing and compensation circuitry that provides a scaling of 24.4 mV/C. Biasing resistors are includes for open thermocouple detection. The 40633 can be cascaded to a total of 128 channels of voltage measurements or 112 channel of thermocouple measurement.

Specifications:

- * No. of Potentiometer : 2 nos.
- * Accepts thermocouple type : J, K, T, E, S, R, B
- * Cold-junction compensation: +24.4 mV/°C(1°C/bit), 0.0V at 0.0°C
- * Over voltage protection : ± 30V Continuous.
- * Common mode voltage : ±10V max
- * Analog output voltage : ±10V
- * Dimension : 204mm x 114mm

VLSI Based Digital Communication Training System

Order Code - 40651

**Specifications:****Clock and signal generation section****Sine wave**

- * Fixed frequency : 250Hz, 500Hz, 1 KHz, 2 KHz
- * Variable frequency : 1Hz ~ 30Hz, 0 ~ 2 Vpp

Sampling clock

- * Frequency : 2 KHz, 4 KHz, 8 KHz, 16 KHz, 32 KHz, 64 KHz, 128 KHz
- * Duty cycle : 10 ~ 90% Selectable in steps of 10%
- * DC signal : 0 ~ 5 V
- * Transmitter clock frequency : 240 KHz fast modes
- * Transmitter frame frequency : 8 KHz
- * Carrier sine waves : 500 KHz (00), 1MHz (00), 1MHz (1800)
- * Data pattern : 8-bit variable NRZ-L pattern
- * PRBS generator : 14-bit

Transmitter Section

- * Analog signal sampling, Sample and hold,
- * Natural sampling, Flat-top sampling
- * 4 channel analog time division multiplexing
- * Odd, even parity and hamming code generator
- * Pulse code modulation
- * ASK, FSK, PSK modulation
- * Data encoding NRZ (L), NRZ (M), NRZ (S), Bi-phase (Manchester), Bi-phase (Mark), Bi-phase (Space), URZ, alternate mark inversion (AMI), uni-polar to bipolar and bipolar to uni-polar
- * Delta / adaptive delta / sigma delta / CVSD modulation Signal compression
- * PAM / PPM / PWM modulation
- * Audio preamplifier with microphone interface

Receiver section

- * 2nd order and 4th order low pass Butterworth filters
- * 4 channel time division de-multiplexing
- * PLL clock recovery
- * Pulse code demodulation
- * Odd, even parity and hamming code recovery
- * Single bit error detection and correction
- * Data decoding NRZ (L), NRZ (M), NRZ (S), Bi-phase (Manchester), Bi-phase (Mark), Bi-phase (Space), URZ, alternate mark inversion (AMI)
- * ASK, FSK, PSK demodulation
- * Delta / adaptive delta / sigma delta / CVSD demodulation Signal expander
- * PAM / PPM / PWM demodulation
- * Audio amplifier with headphone / speaker interface

Experiments:**Study of sampling techniques**

- * Natural sampling, Sample and hold, Flat top sampling

Effect of various sampling frequencies and duty cycles

- * Effect of sampling frequency Effect of duty cycle

Effect of order of the low pass filter**Study of TDM with different receiver****synchronization techniques**

- * Using the direct synchronization technique
- * Clock recovery through PLI
- * Clock recovery through threshold detector

Study of pulse code modulation and demodulation

- * Direct synchronization technique
- * Bit synchronization technique
- * Frame synchronization technique

Effects of parities and hamming code on PCM data

- * None parity, Even parity, Odd parity, Hamming code

Study of PRBS**Study of various data encoding and decoding techniques**

- * NRZ- L, NRZ- M, NRZ- S. 810-1. BIO-M, 810-S. URZ
- * AMI encoding and decoding
- * Unipolar to bipolar
- * Bipolar to unipolar

Study of various carrier modulation and demodulation techniques

- * ASK modulation and demodulation
- * FSK modulation and demodulation
- * PSK modulation and demodulation
- * Study of delta modulation and demodulation
- * Study of slope overload and increased integrator gain
- * Study of adaptive delta modulation and demodulation
- * Study of sigma delta modulation and demodulation
- * Study of continuously variable slope detector modulation and demodulation.
- * Study of companding system
- * Voice communication
- * Study of pulse width modulation and demodulation.
- * Study of pulse position modulation and demodulation Switch faults

Telephone Trainer

Order Code - 10901



Telephone Trainer is complete working model of telephone. It gives hands on experience on basic telephony concepts, working and different experiments on telephone. The trainer comes complete with exhaustive experiment manual, accessories, test points, and LED's for indication. The complete circuit is printed on single sided PCB in section wise format, depicting the complete flow of system. Practical experience on this trainer carries great educative value for Science & Engineering Students.

Features:

01. Single sided PCB depicting different working sections.
02. 35 test points and LED's provided on board to study signals.
03. Power from external telephone line, no power supply is required.
04. Pulse dialing as well as tone dialing facility.
05. Dialer and ringer section.
06. Mute, Redial and ON / OFF hook switches.
07. Telephone Handset: 1 Nos.

Technical Specifications :

01. Line in section : One dot line connection port.
02. Handset : One handset connection port.
03. Keyboard : 4x3 matrix keyboard.
04. Dialer : Tone and pulse.
05. Facilities : Redial up to 32 digits, Mute, Redial, Flash, Pause switches.
06. Indicators : Line in, Hook, tone and ringer, Call mute section.
07. Control : Ringer volume control, Ringer speed control.
08. Speech path : Fully Non-Blocking.
09. Dial pulse ratio : 10 pps + / - 10%.
10. Tone frequency : 430 Hz.
11. Input power : From telephone line.

Experiments:

01. Understanding of telephone.
02. Study of telephone features.
03. Study of speech circuit.
04. Study of ringer.
05. Study of tone dialing.
06. Study of pulse dialing.
07. Study of switching mechanism between subscriber
 - (a) Incoming call.
 - (b) Outgoing call.

Test Points:

01. 35 No. of TP's test points are provided on board to observe intermediate signals.
- * Good Quality, reliable terminal/sockets are provided at appropriate places on panel for connections / observation of waveforms.
- * Strongly supported by detailed Operating Instructions, giving details of Object, Theory, Design procedures, Report Suggestions and Book

PA (Public Address) System Trainer

Order Code - 10902



This Trainer has been designed with a view to provide practical and experimental Knowledge of general circuit of PA (Public Address) System Trainer on Single P.C.B. of size 300 x 400mm".

Practical experience on this Trainer carries great educative value for Science & Engineering Students.

Object:

To study the circuit & operation of a PA system and observe various intermediate waveforms.

Features:

The P.A. System Trainer consists of :

01. The complete circuit of a public address amplifier is printed on a single PCB.
02. All part are soldered on PCB.
03. Explanation, Observation, Alignment and adjustment of internal and external control possible due to single PCB.
04. Easy identification of different parts is possible at a glance.
05. Easy measurement of voltages and observation of waveforms at any point. Also typical voltages and waveforms are provided.
06. A manual having practical detail is provided with the trainer.
07. The whole circuit of public address amplifier is explained sectionwise in the manual.

Technical Specifications :

01. Signal to noise ratio : 60 dB.
02. Frequency response : 100 Hz to 15000 Hz.
03. Amplifier with two mic. inputs.
04. One mic. & One Aux. inputs.
05. Power supply : 220VAC 50 Hz.
06. Power Output : 80 Watt RMS Max.
07. Tone control : Bass, Treble.
08. Audio Monitoring Indicators.
09. Output Tap for speaker matching : 4, 8 & 16 Ohms.
- * Good Quality, reliable terminal/sockets are provided at appropriate places on panel for connections / observation of waveforms.
- * Strongly supported by detailed Operating Instructions, giving details of Object, Theory, Design procedures, Report Suggestions and Book Reference

Accessories:

- * Three Mic. with lead & connector
- * One speaker 4 Ohm, 4 Watt provided for normal operation

Mobile Phone Trainer

Order Code - 10903



MOBILE PHONE TRAINER kit has capability of full

duplex mobile communication. Provides basic theory and working fundamentals of a 2G hand set based on the NOKIA 3310/3315. This trainer kit designed with a view to provide network, power supply, charging & user interface circuits for their practical and theoretical study based on NOKIA 3310/3315. Practical experience on this board carries great educative value for Science and Engineering Students.

Features:

01. Real time Mobile Operation
02. Expanded and open trainer
03. Full understanding of mobile phone working
04. Frequency measurement and band verification
05. Provides study of all sections in mobile phone
06. TX/RX Frequency measurements
07. 2G technology & GMSK signals
08. GSM data rate
09. Detail study of User Interface Control signals
10. Detail study of SIM Operation
11. Battery identification and charging study
12. Switch Faults

Technical Specifications :

Cellular System	: EGSM/GSM 900
Rx Frequency Band	: EGSM 925, 960MHz
	: GSM 900, 935, 960MHz
Tx Frequency Band	: EGSM 880, 890MHz
	: GSM 900, 890, 915MHz
Output Power	: +5V, +33dBm/32mW, 2W
Channel Spacing	: 200 KHz
Antenna	: Loop type, 50W
Display	: 84 x 48 pixels
On Board sections	: Antenna, Keypad, SIM, Charging Circuit, Clock, User interface such as Buzzer, Vibrator, LEDs.
No. of test points	: 54
No. of switched fault	: 20
Features that can be set	: Screen savers, Ring tones, Logos, SMS etc.
Accessories included	: Battery, Mains cord, Manual, Hands Free Kit
Power Requirement	: 220V ± 10% 50 Hz
Power consumption	: 3.6 Watts (Approx)
Fuse	: 1.5 amps

Experiments That Can Be Performed:

01. To study and measure frequency band
02. To study and measure the GMSK signals such as Tx.1/ QRx1/Q
03. To study and observe the system CLK
04. Observation of Audio signal
05. To study and measure the power supply
06. Study of charging phenomena with fault insertion
07. Study and measure PWM signal of UI circuit such as Vibrator LED buzzer
08. Measurement of LED with fault insertion
09. Keypad study with fault insertion
10. Observe and measure the SIM Card CLK with fault insertion

CD/VCD Player Trainer

Order Code - 10904



Complete working model of CD/VCD Player Trainer. It gives hands on experience on basic concepts, working of CD/VCD Player. The trainer comes complete with exhaustive manual, accessories, test points, and LED's for indication. The complete circuit is printed on single sided PCB in section wise format, depicting the complete flow of system.

Features:

01. The complete circuit of a CD/VCD player is printed on a single P.C.B.
02. The digital signal processing section is in assembled open out P.C.B.
03. Explanation, Observation, Alignment and adjustment of Internal and external possible due to single P.C.B.
04. Easy identification of different parts and Mechanism at a glance.
05. Easy measurement of voltage and observation of waveforms at any point.
06. A manual having practical detail is provided with the trainer.
07. The whole circuit of the CD/VCD Player is explained sectionwise in detail in the manual.

Technical Specifications :

01. Power Supply	: 230V AC, 50Hz
02. Function Switches	: Play/ Pause, Forward, Rewind, Stop, Program select/ Repeat, Skip Forward, Skip Reverse, Open/ Close, Tracks Select.
03. Display	: Program, Time and Track status display.
04. Laser	: Semiconductor Laser (780nm).
05. Frequency Range	: 5 - 20000Hz.
06. T.V. System	: PAL and NTSC
07. Audio Output	: 200W PMPO (100W x 2 Channels)
08. Speakers	: 2 Nos.
09. Modulation	: EFM
10. Quantization	: 16 bit Linear
11. CD Format	: Audio CD, Video CD, Mp3 CD can be played.
12. Output Sockets	: Audio Out, Video Out, RF Out (Channel 2).
Remote Controls	: Play/ Pause, Forward, Rewind, Stop, Program select/ Repeat, Skip Forward, Skip Reverse, Open/ Close, Tracks Select.
Sampling Frequency	: 44.1KHz
Distortion	: 5 to 10% for expanded PCB.
Controls	: Bass, Treble, and Volume.
Test points	: 15
Switch Faults	: 17
Standard Accessories	: 1. Video CD -1 Nos. 2. Speakers -2 Nos.

- practical details - 1 No.
- 4. Audio / Video Connector With Lead
- 5. Remote Control

AM/ FM Radio Trainer

Order Code - 10905



AM/FM Radio Trainer Kit has components placed over their corresponding symbols in the schematic drawing on the surface of the printed circuit board thereby maximizing the learning process and explain theory of operation of the radios. The radios are constructed in sections with each section being completely tested before moving on to the next, reducing difficult troubleshooting associated with some other kits. Trainer includes a high quality printed circuit board with schematic printed on the surface. The manual is easy to understand and assumes no previous electronics knowledge. Trainer forms a "Superheterodyne" receiver of standard AM (amplitude modulation) and FM (frequency modulated) broadcast frequencies.

Object:

01. To Study AM RADIO RECEIVER
02. To Study FM RADIO RECEIVER

Specifications:

01. Am Radio Section:

- Tuning Range : 520 KHz – 1620 KHz
- IF Frequency : 455 KHz
- Tracking : + - 3 db from 700 KHz to 1400 KHz
- 10 db Signal to Noise at 200 microvolt typical

02. Fm Radio Section:

- Tuning Range : 88 MHz – 108 MHz
- IF Frequency : 10.7 MHz
- Tracking : + - 5 db from 90 MHz to 106 MHz
- DETECTOR : Uses Ratio detector and full time auto frequency control
- 10 db Signal to Noise at 12 microvolt typical

03. Nine Sections:

- Audio Amplifier Circuit
- AM Detector Circuit
- AM IF Circuit
- AM Amplifier Circuit
- AM Mixer and Oscillator Circuit
- FM Detector Circuit
- First FM IF AMPLIFIER Circuit
- Second FM IF AMPLIFIER Circuit
- FM Radio Frequency Stages

04. Other:

- Test Points : 15 Numbered as TP1 to TP15
- Trainer is complete with : Ear Phone & Operational/ Instruction Manual.
- Loud speaker on panel

05. Operative Voltage :

- 9Volt DC Battery (Provided)
- 9V DC Power Adaptor (Provided)

Multimedia Computer Trainer

Order Code - 10906



MULTIMEDIA COMPUTER TRAINER This trainer provides training of hardware and software theory of a based on Intel Celeron CPU with experiments on 98 & XP.

Practical experience on this board carries great educative value for Science and Engineering Students.

Features:

01. The Different circuit boards of PC/AT Computer are exposed on a PCB.
02. Troubleshooting and fault finding procedure explained in details.
03. Artificial fault creation facilities are provided by the switches.
04. About more than 60 faults can be demonstrated at a glance.
05. Easy measurement of voltage and observation of waveforms. The typical voltages and waveforms are provided.
06. An Exhaustive and Skilled oriented comprehensive instructional manual with complete theory explanation.

Specifications:

(A) System:

01. C.P.U with fan : Intel Celeron.
02. Mother board : Mercury (v2.0, P1865D7).
03. Memory (RAM) : 256 MB DDR RAM.
04. Display adaptor card : Built-in-motherboard.
05. Hard disk : 80 GB-Seagate.
06. Monitor : 15" Color SVGA-LG / SAMSUNG
07. Key board : Multimedia key board (I-ball / EQ.)
08. Mouse : Optical mouse with pad (I-ball / EQ.)
09. SMPS : 450 Watts (ATX).
10. DVD Rom/Writer : LG / SAMSUNG
11. Sound card : Built-in-motherboard.
12. Speakers and Mike : Stereo speakers.
13. TV tuner card : PCI with Rfin, Video in, s-video in
14. Video Camara : Web cam/Easy tune
15. Modem : 56.6 kbps.
16. Ethernet : Built-in-motherboard.

(B) Training Package:

01. Trainer PCB board with fault creating facilities.
02. Training package manual

(C) Optional:

01. TV tuner card.

List Of Accessories

01. Mother board driver CD with cover 1 No.
02. Bootable CD with cover 1 No.
03. Bootable Floppy 2 No.
04. Mains cord detachable (for monitor and trainer) 2 No.
05. Trainer Key 1 No.
06. Operating Manual 1 No.
07. Web Camera (Micro soft life cam VX-1000 / EQ.) 1 No.

08. Speaker Set (Stereo speakers) 1 No.
09. Optical Mouse with Pad (I Ball / EQ.) 1 No.
10. Multimedia Key Board (I Ball / EQ.) 1 No.
11. PC Monitor 15" Color SVGA-LG / SAMSUNG 1 No.
12. Microphone (Philips / EQ.) 1 No.
13. Head phone (I Ball / EQ.) 1 No.
14. BNC to Test prod cable 1 No.

Colour TV Trainer - 36 CM

Order Code - 10907



Colour TV Trainer is an ideal training equipment to teach the operation of colour TV receivers. The complete circuit of colour TV Receiver is printed on single PCB. Sectionwise coloured printing on PCB helps in easy understanding of function of different blocks. More than 50 test points allow the analysis and monitoring of the signals in different sections. It safe to operate because all the test points are protected against accidental shortcircuits. By using the fault simulation method, it is possible to introduce the most common breakdown and their rectification. Technical manual includes circuit diagram with component list of each section. Test point details with typical voltages and wave forms are provided in the manual. The Trainer has been specially designed with Sliding Main Board with locking facility. The detachable CRT Unit is another feature. It can also be used as a normal desktop Colour TV Receiver.

01. TV Receiver in open form with all components & controls placed on single PCB
02. Each circuit block shown in different colour for easy identification
03. Solderless fault creation & Rectification
04. Legend printing on PCB
05. More than 50 test points
06. Compact Design-Sliding Main board with locking facility
07. Can be used as Desktop Colour TV
08. Fully documented Operating Manual with glossary of terms
09. Manual and remote control operation
10. Detachable CRT Unit.

Experiments that can be performed

01. Study of RF-Section through test points, fault simulation & rectification
02. Study of VIF- section through test point, fault simulation & rectification
03. Study of Video/Chroma section through test points, fault simulation & rectification
04. Study of System Control Section through test points, faults simulation & rectification
05. Study circuit of Horizontal & Vertical Oscillator & Output sections
06. Study of circuit of Horizontal & Vertical output sections through test points fault simulation & rectification
07. Study of R-GB video output Section
08. study of Audio Sound section and many more.

Technical Specifications:

Standard	: CCIR-B-PAL-G, 625 Lines
Channels	: 230 2-4VHP: I (VL), 5 - 12VHPIII (VH) 12 - 100 : BAND IV & V, else : SBAND & HYPERBAND
Picture Tube Size	: 36cms. Diagonal
RF Input Impedance:	75W
Circuit Blocks	: System Control Circuit, Video IF, Sound, Tuner Section, Horizontal Oscillator, Horizontal Output, Vertical Oscillator, Vertical output, Video & Chroma Section, Power Supply, Avsections
ON Screen Display to set	: Volume Brightness, Contrast, Colour Channel & Band Selection Tuning
Panel Control	: ON-OFF Switch, Stand by Menu Vol + / - Prog + / -
Remote Control Function	: Volume, Brightness, Stand by, Colour, Contrast, Channel Selection, Audio Mute, AV Mode, Zoom, Swap, Scan Child Lock
PCB Size	: 475 x 375mm
No. Pf Faults	: 21
No. of test Points	: 55
I.F. Frequency	: Video - 38.9MHz, Audio 33.4MHz
Speaker Size	: 50 x 125mm
Accelerating Potential	: 24KVmax
Operating Voltage for EHT	: 110V
Mains Supply	: 230V ± 15%, 60Hz on request
Power Consumption	: 75VA (Approx)

Oscilloscope / Demonstrator Trainer

Order Code - 10909



Oscilloscope Demonstrator Trainer is specifically designed for the study of working of an oscilloscope in an open form. The Controls are placed actually at the place as they are in the layout schematic. Thus a trainee can easily locate any section, & components in the section and study it thoroughly. The function controls and the adjustment controls are fully accessible to the trainee to verify their effect on the working of the scope. Creation of Faults and rectification of faults are important exercise covered in the experiments. An illustrated Block and Circuit Schematic and the adjustment plan right in front of the trainee's eyes helps him to correlate each operation during the demonstration.

- * Oscilloscope in open form with all components and controls placed on single PCB
- * Amplifier, Time base, Channel section signal available on test points
- * Separate sections for PS, EHT, VA, HA, TB & Trigger for easy identification
- * Fault creation & rectification provided

- * Track printing with different colours on different sections on component board for easy circuit training
- * Legend Printing on PCB for easy identification of components
- * Can be used as a standard 20 MHz Dual Trace Oscilloscope

Technical Specifications:

Operating Modes

Channel I, Channel II, Channel I & II Alternate or chopped, Controls provided on PCB. Channel selection signals available at Test points. X-Y operation 1:1

Vertical deflection (Y):

(Identical channels)

Bandwidth : DC-20 MHz (-3 dB)
 Risetime : 17.5 ns (approx.)
 Deflection coefficients : 12 calibrated steps 5 mV / cm
 - : 20 V / cm (1-2-5 sequence)
 Accuracy : $\pm 3\%$
 Input Impedance : 1 MW II 30 pF
 Input coupling : DC - AC - GND
 Maximum Input voltage : 350 V (DC + Peak AC) Pre-Amp, Final Amp Outputs at Test Points.

Timebase:

Time coefficients : 18 calibrated steps, 0.5 μ s / cm - 0.2 s / cm (1-2-5 sequence) with magnifier x 5 to 100 ns / cm, with variable control to 40 ns / cm
 Accuracy : $\pm 3\%$ (in Cal position) TB generation at Test Points Sweep Output : 5 V (approx.)

Trigger System:

Modes : Automatic or Variable
 Source : CH I, CH II, External
 Slope : Positive or Negative
 Coupling : AC, TV Frame
 Sensitivity : Int 5 mm, Ext 1 V (approx.)
 Trigger Bandwidth : 30 Mhz

Horizontal Deflection (X)

Bandwidth : DC - 2 MHz (-3 dB)
 X - Y mode : Phase Shift $< 5^\circ$ at 50 KHz
 Deflection coefficients : 12 calibrated steps 5 mV / cm
 - : 20 V / cm (1-2-5 sequence)
 Input Impedance : 1 MW II 30 pF

Component Tester :

Test Voltage : Max 8.6 V (Open) rms
 Test Current : Max 8 mA (Shorted) rms
 Test Frequency : 50 Hz, Test circuit grounded to chassis

General Information

Cathode Ray Tube : 140 mm Rectangular medium short persistence (P31)
 Accelerating potential : 1.9 KV (approx.)
 Display : 8 \times 10 cm
 Calibrator : Square Wave generator 1 KHz (approx.), 0.2 V $\pm 1\%$ for probe compensation
 Z Modulation : TTL level
 Stabilized Power Supply : All operating voltages including the EHT
 Power Supply : 220 V $\pm 10\%$, 50 Hz / 60 Hz on request
 Power Consumption : 40 VA (approx.)

Operating Temp. : 0-40°, 95 % RH
 Finish : Off white with side handle
 Fault Simulation : Total 15 Faults included

Included Accessories :

DMM 1 No., Manual 1 No., Student manual 1 No., BNC-BNC Cable 1 No., BNC - Probe tip Cable 1 No., Test Prods 1 pair, Additional Jumpers 10

Optional Accessories : Switchable Probe X 1 - X 10

Power Supply Trainer

Order Code - 10912



The Power Supply Trainer is a comprehensive training system for the laboratories. It is useful in understanding the various concepts of a DC Power Supply. As we know that power supply is a very basic element of any electronic circuit or appliance. Starting from a mobile charger to a huge Computer system, each needs an efficient Power Supply. It is essential for an engineer to know basic concepts of Electronic Power Supplies. This trainer describes the Transformer, Rectifiers, Filters, Regulators, Role of Bleeder resistor, Load and Line regulation etc. While performing any experiment students have to connect the links by patch cords so it is very helpful for students to learn the inputs and outputs of different sections of any Power Supply circuit. It also consists of a demonstration bridge which is made up of LEDs for visualization of each part of an AC cycle.

Feature:

01. Real time appearance of components
02. Test points are provided in different sections of Power Supply
03. Demonstration bridge
04. Designed by considering all the safety standards
05. Provided with a detailed Operating manual
06. Low cost yet including many experiments

Technical Specifications:

Input : 230 V $\pm 10\%$, 50 Hz

Outputs

Zener diode outputs : 10 V, 5.6 V regulated

Regulators outputs : +12 V regulated

-12 V regulated

1.8 to 17 V adjustable

Load : 5 K variable with 1 K fixed resistance.

Bleeder Resistor : 5 K variable with 1 K fixed resistance.

Astable Multivibrator : 1 Hz, 14 Vpp

Transformer : Primary 0 to 220 V Secondary 18-0-18, 6-0-6 (500 mA)

Fuse : 500 mA (slow blow, spare fuse is given in mains socket)

Experiments that can be performed

01. Study of Transformers and its working
02. Study of Two diode Full Wave Rectifier
03. Study of Full Wave Bridge Rectifier
04. Study of Demonstration Bridge
05. Study of Ripple Factor and to calculate Ripple Factor of Half Wave, Full Wave and Bridge Rectifier

06. Study of LC and π filter
07. Study of Bleeder Resistor and its effect on load current
08. Study of Zener Diode as Regulator
09. Study of Positive Regulated Supply
10. Study of Negative Regulated Supply
11. Study of Adjustable Regulated Supply
12. Study of Line Regulation
13. Study of Load Regulation

SMPS Trainer

Order Code - 10913



The SMPS trainer is a very adaptable product that has been designed to explain a very remarkable and frequently used Switching based power supply - The SMPS (Switched Mode Power Supply). The Trainer is designed to understand each section of SMPS in straight forward way. Various test points has been provided so that one can observe the inputs and outputs of each block contained. Being different from a conventional block diagram internal structures of different blocks are also shown. Switching Transformer and Chopper (the Heart of SMPS) are also presented to readily understand their operation and pin configuration.

Features:

01. A low cost Training System demonstrating all basic concepts of SMPS
02. In depth elucidation of Switching Transformer, which is one of the most important component of SMPS
03. Variac can be connected with the kit
04. Fault identification feature enabled
05. Easy illustration of each block
06. Designed with considering all safety standards
07. Provided with a detailed Operating manual

Technical Specifications:

Input : 80 to 230 VAC $\pm 10\%$, 50 / 60 Hz
 Outputs : +12 V DC regulated
 : -12 V DC regulated
 : +5 V DC regulated

Switching Transformer

Input : 320 V DC switching at 132 KHz
 Output : 30 VAC (approx)
 Fuse : 500 mA (Slow blow, spare fuse is given with mains socket)

Experiments that can be performed

01. Study of Switching Transformer
02. Study of PWM switching device
03. Study of Optocoupler
04. Study of Regulation
05. Study of SMPS with Variac input
06. Study of various faults and their removal in SMPS circuit

UPS Trainer

Order Code - 10914



The UPS trainer is a very versatile training system, has been designed to explain a very interesting and frequently used switching based power supply - The UPS (Uninterrupted Power Supply).

The product is designed keeping in mind that a student can understand each block of UPS in a very easy way. Various test points have been provided so that one can check inputs and outputs of each block contained. Being different from a conventional block diagram internal structure of blocks is also shown. AVR (Automatic Voltage Regulator) is presented in such a way that a student can readily understand its functioning and pin configuration. Since UPS is different from an inverter because its switching changeover time is less than 3 ms which is very less so a computer system doesn't get reboot.

Features:

01. In depth explanation of PWM switching technology, which is one of the most important feature of UPS
02. A Low cost product demonstrating all basic concepts of UPS
03. Various test points are provided so that one can easily measures the voltages of different sections
04. Designed considering all safety standards
05. Provided with a detailed Operating manual

Technical Specifications:

Input : 190 to 260 V 10%, 50 Hz
 Output : 230 V

Transformer specifications

Input : 12 - 0 - 12 V
 Outputs : 0, 190, 220, 240, 260 V 18 - 0 for battery charging

Experiments that can be performed

01. Study of PWM Technology
02. To understand the overall functioning of UPS Trainer
03. Study of AVR transformer section of UPS
04. To study the UPS circuit in load condition
05. To identify different faults and to study the systematic procedure of their troubleshooting in UPS circuit

Function Generator Trainer

Order Code - 10915



The "Function Generator Trainer" is a versatile training kit for Electrical and Electronics Laboratories. It is designed to explain the fundamentals of Signal Generation. A Function Generator is a product that can produce various patterns of Voltage at a variety of

Frequencies and Amplitudes. This Function Generator Trainer allows students to produce the different waveforms and to understand the concept of their generation.

Features :

01. A low cost trainer demonstrating all basic concepts of Function Generator
02. Exclusive presentation and easy illustration of each block
03. Designed considering all safety standards
04. Low sine wave distortion
05. Low variation with temperature
06. Fault creation and troubleshooting
07. Onboard Frequency range display
08. Provided with elaborated operating manual

Technical Specifications :

- Frequency Ranges : Selectable
- (a) 1 Hz to 10 Hz
 - (b) 10 Hz to 100 Hz
 - (c) 100 Hz to 1 KHz
 - (d) 1 KHz to 10 KHz
 - (e) 10 KHz to 100 KHz

Amplitude Control Output

- Sine Wave : 6V VPP
 Square Wave : 6V VPP
 Triangular Wave : 6V VPP
 TTL Output : 5V
 Sine Wave Generation : By Wave Shaping Circuit
 Switched Faults : 4 Nos.
 Fuse : 500 mA, slow blow
 Power Supply : 220VAC, 50 Hz \pm 10%

List of Experiments :

01. Study of Electrical Waveforms generated by Function Generator.
02. Study of Triangular Waveform Generation.
03. Study of Sinusoidal Waveform Generation.
04. Study of Square Waveform Generation.
05. Study of Duty Cycle of Square Waveform.
06. Study of TTL Waveform Generation.
07. To create and identify different faults in the circuit and study their troubleshooting methods.

Frequency Counter Trainer

Order Code - 10916



Frequency Counter Trainer, is an exclusive and attractively designed product to demonstrate the fundamental principle and functioning of Frequency Counter. It includes various circuits namely, attenuator circuit, wave shaping circuit, frequency divider circuit, display driver circuit, and gate time circuit. All these circuits are incorporated on a single board for study and Verification. Simple representation of all the circuits can explain corresponding functionality in a very easy way to perceive the logics.

Features :

01. Exclusive and Compact design
02. Stand alone operation
03. Inbuilt +5V, -12V SMPS

04. Diagrammatic representation of Frequency Counter circuit

05. Low cost

06. e-Manual

Technical Specifications :

- Frequency Range : 20 Hz - 30 MHz
 Resolution : 10 Hz (60 KHz Range)
 10 KHz (30 MHz Range)
 Sensitivity : 0.5 Volts
 Accuracy : \pm (0.5% +1D) of rdg
 Attenuation : 1 : 1, 1 : 20
 Input Coupling : AC
 Input Impedance : 1 MW
 Max. Input Voltage : 200 V (DC + AC Peak)
 Display : 4 digits, 7 Segment LED Display

List of Experiments :

01. Study of Frequency Counter
02. Study of Attenuator Circuit
03. Study of Wave Shaping Circuit
04. Study of Frequency Divider Circuit
05. Study of Frequency Counter and Display Driver Circuit
06. Study of Gate Time Circuit
07. Study of Sensitivity of Frequency Counter

RFID Trainer

Order Code - 10917



RFID Application Demonstrator

- 01 RFID Security System
- 02 RFID Toll Tax

RFID Trainer is a versatile training system for laboratories. It consists of many experiments to understand the basics of the Technology.

RFID is the abbreviated form of Radio Frequency Identification. RFID means storing and retrieving data through Electromagnetic Transmission to a RF compatible circuit. RFID Technology can be viewed as a new generation of Technology that replaces barcodes. However it is a core Technology with much wider range of applications in logistics, traffic, security, monitoring application etc.

It is a passive RFID system, working on 13.56 MHz Frequency range and supports multi protocols. Our system has a RFID reader module with an antenna and some RFID tag cards which support different protocols and each has different U.I.D (Unique Identification) number. The trainer kit consists of a reader chip for reading the tag and a microcontroller for processing the data. The transceiver chip is a reader chip which supports ISO/IEC 14443A, 14443B, 15693 standards. Tags contain different Ics for different protocols.

Features :

01. Highly integrated analog circuitry to Demodulate
02. Decode and Respond
03. 13.56 MHz multi protocol support
04. Provided with LCD and software
05. RS-232 Interface
06. On board LED Indication

07. On board Buzzer indication
08. On board Antenna
09. Provided with application program software
10. Test points are provided to observe the signals

Technical Specifications:

Operating Frequency	: 13.56 MHz
Modulation Type	: ASK
Operating Range	: Less than 10 cm
Protocol Support	: ISO 14443A ISO 14443B ISO 15693
Application Software	: This programme helps the students to understand the attendance records by using RFID technology
Supply Voltage	: 3.3 V for controller and Reader, 5 V for LCD display
Micro Controller	: 89C51 ED2 with 256 KByte RAM and 64 KByte ROM
Antenna	: Inductively coupled coil type
Power Supply	: 230 V \pm 10%, 50 Hz
Fuse	: 250 mA

ATM Demonstrator

Order Code - 10918



The ATM Demonstrator is a very special Training System that has been designed to understand the working of an Automated Teller machine. The product is designed in such a way that a student can understand each block of ATM in a very easy way. Various test points are given to check inputs and outputs of each block. Being different from a conventional block diagram, internal structures of different blocks are also shown.

Features :

01. Exclusive appearance and easy illustration of ATM Technology
02. A Low cost training system demonstrating all basic concepts of ATM
03. Various test points are provided for study purpose
04. Provided with an extensive manual
05. 2 years Warranty

Technical Specification:

Input	: 6 V DC
Display	: 16 \times 2 Characters LCD
Microcontroller	: PIC16F877A , PIC16F84A
PC-Interface	: RS - 232 (DB-9)
Key Matrix	: 4 \times 3

Experiments that can be performed

01. Study of ATM Demonstrator operation
02. Study of Micro controller based ATM card
03. Study of Microcontroller processing with Keypad and LCD
04. Study of ATM PC interfacing
05. Study of ATM Application Software

Bluetooth Technology Trainer

Order Code - 10919



The Bluetooth Technology Trainer, is designed considering the International Communication Standards. It is helpful for students and researchers in the field of RF and IT engineering to understand the basic concepts of Bluetooth Technology. Based on Class 2 Bluetooth System having range up to 10 meters and is fully compliant for Data Communication. It consists of two identical modules and any one of these can be selected as a Master or Slave for Communication. This Training System can be connected to PC for operation and execution of Bluetooth AT Commands. Bluetooth standard AT commands can be run on the graphical LCD display also with the help of keyboard.

Features :

01. Graphical LCD display
02. Bluetooth enabled devices detection
03. Designed considering all the Communication Standards
04. Data Generator is provided on-board
05. User friendly software
06. Equipped with UART & USB port
07. Computer independent Training System
08. Test points are provided to observe signals

Technical Specifications:

Carrier Frequency	: 2.40 GHz to 2.48 GHz
Bandwidth	: 80 MHz
Modulation	: GFSK, 1Mbps
No. of Channels	: 79
Channel Intervals	: 1 MHz
Frequency Hopping	: 1600 hops / sec
Transmission Power	: +4dBm max (2.5mW)
Transmission Range	: 10 meter approximate
Output Interface	: UART and USB
Power Supply	: 230V \pm 10%, 50 Hz
Operating Voltage	: 5V
Operating Temperature Range	: - 20°C to 85°C
Antenna	: Whip Antenna

Experiments that can be performed

01. Study the functioning of Bluetooth Trainer
02. Pairing of Slave unit with Master unit using software
03. Study of AT commands
04. Data Communication using UART
05. Data Communication using USB
06. Study of Communication using internal data
07. Study of RF signals

Optional

Handheld Spectrum Analyzer - 3.3 Ghz

Inverter Trainer

Order Code - 10920A



The Inverter trainer is a very versatile training system, has been designed to explain a very interesting and frequently used switching based power supply - The Inverter (Uninterrupted Power Supply).

The product is designed keeping in mind that a student can understand each block of Inverter in a very easy way. Various test points have been provided so that one can check inputs and outputs of each block contained. Being different from a conventional block diagram internal structure of blocks is also shown. AVR (Automatic Voltage Regulator) is presented in such a way that a student can readily understand its functioning and pin configuration. Since Inverter is different from an inverter because its switching changeover time is less than 3 mS which is very less so a computer system doesn't get reboot.

Features:

- 01. In depth explanation of PWM switching technology, which is one of the most important feature of Inverter
- 02. A Low cost product demonstrating all basic concepts of Inverter
- 03. Various test points are provided so that one can easily measures the voltages of different sections
- 04. Designed considering all safety standards
- 05. Provided with a detailed Operating manual

Technical Specification:

Input : 190 to 260 V 10%, 50 Hz
 Output : 230 V

Transformer specifications

Input : 12 - 0 - 12 V
 Outputs : 0, 190, 220, 240, 260 V
 18 - 0 for battery charging

Experiments than can be performed

- 01. Study of PWM Technology
- 02. To understand the overall functioning of Inverter Trainer
- 03. Study of AVR transformer section of Inverter
- 04. To study the Inverter circuit in load condition
- 05. To identify different faults and to study the systematic procedure of their troubleshooting in Inverter circuit

Barcode Technology Trainer

Order Code - 10921



The Barcode Technology Trainer is a useful Training System for students to understand the basic concept and fundamentals of this technology. Barcodes are fast, easy and accurate data entry method. The correct use of barcodes can save the time and

increase an organization's efficiency. Barcode is an automatic identification technology that encodes information into an array of parallel bars and spaces of varying widths. This Training System provides understanding about how barcodes are generated and applications of barcodes. The system is provided with the detailed description of each block with various test points and explanation in the manual. Conversion of Optical signal into the Electrical signal is shown very clearly so a student can understand how and where CCDs (Charge Coupled Devices) are used in opto-electrical conversion circuits. This system also explains, how data is acquired from barcode strips, how conversion of scanned analog data into digital data for PC, how decoding of incoming data is taking place etc. Its software contains the operation of barcode scanning probe, generation of barcodes and an application of barcodes.

Features:

- 01. Complete details of the Barcode Technology
- 02. Detailed explanation of each block with the given test points
- 03. Provided with Application software
- 04. Facility of Barcode Generation
- 05. User friendly manual

Technical Specification:

Power Supply : +5 V DC provided from computer by PS/2 Interfacing
 Current : 100 mA (while scanning)
 Scan-Rate : 100 Scans per second (Typical)
 Scanning distance : 0 to 30 mm
 Standards Supports : UPC/EAN, UPC/EAN with supplemental, UCC/EAN 128, Code 39, Code 39 Full ASCII, Code 39 Tri Optic, Code 128, Code 128 Full ASCII, Codabar, Interleaved 2/5
 Interface supported : PS/2
 Ambient Light Immunity : Immune to direct exposure of normal office and factory lighting conditions, as well as direct exposure to sunlight.

Experiments than can be performed

- 01. To Understand the working of Barcode Trainer
- 02. To study the conversion of Light into an Electrical signal
- 03. To understand the scanned output of ADC Barcode signal
- 04. To study Digital Signal Processing Block
- 05. To understand the generation of Barcodes
- 06. To understand commercial applications of Barcodes

Refrigeration Trainer

Order Code - 10922



Refrigeration Trainer allows students & industry professionals to learn the fundamentals of Simple Vapour Compression Refrigeration System. The design

of this Refrigeration Training System is to allow the user to study this Technology in great detail. The training system introduces various sub-systems with real components.

The training system brings a comprehensive view of the entire Refrigeration system. Actual component study and their interconnection, functions, operation, diagnosis, etc. are a part of the scope of training. The construction of the trainer is on a main platform unit mounted on a trolley. This helps the students to place the trainer at their desired position. However, the height of the trainer is as such, the students can comfortably observe the reading while performing the experiments. The unit is opened, in order to provide an open exposure to the students for understanding the importance of each component in the process cycle.

In this trainer, students can learn how to calculate the Coefficient of Performance (C.O.P.) of a compressor, based on which he / she can know the capacity of a compressor. Apart from this, students are also able to know the power consumed by the compressor. The front panel also includes Toggle Switches, LCD, Pressure Dials, Voltmeter and Ammeter.

Features:

01. Refrigerant (R134) used is non-poisonous, harmless to body and eco-friendly
02. Compact and Self-contained
03. Mounted on trolley for mobility
04. Digital LCD for Temperature
05. Multi point temperature measurement
06. Process Diagram on front panel
07. Easy component identification

Technical Specification:

Condenser	: 10 11 2 Turns
Motor	: 230 VAC – 50 Hz, 0.40 Amps, 9 watt and 1360 RPM
Evaporator & Tank	: Capacity : 20 litres
Compressor	: 1/3 HP, 925 BTU, 150 watt, R134 a (Refrigerant), 220 VAC – 50 Hz,
Drier	: 1/4- Threaded (male)
Pressure Gauge (P1, High)	: 0 – 300 PSIG & 0 – 21 kg / cm ²
Pressure Gauge (P2, Low)	: -30 to 150 PSIG
Ammeter	: 0 to 5 Amps AC
Voltmeter	: 0 to 300 VAC
Pump	: Submersible, 220

Experiments than can be performed

01. To study the Simple Vapour Compression Refrigeration System (SVCR)
02. To calculate the Co-efficient of Performance (C.O.P)
03. To calculate the power consumption of the compressor

Bernoulli's Theorem Demonstrator

Order Code - 10923

Bernoulli's Theorem Demonstrator facilitates the students and the industrial professionals to explore the fundamentals of "Bernoulli's Theorem" in Fluid Mechanics. It states that, in a steady flow the sum of all forms of mechanical energy



(kinetic, potential and pressure energy) in a fluid along a streamline is the same at all points on that streamline.

It consists of classical venture of clear acrylic. A series of wall tapping allows measurement of static pressure distribution of convergent duct, while a total head tube is provide at the centre of throat. These tapping are connected to a bank of manometer tube.

This unit has been designed with Hydraulic Bench to study the characteristic flow through convergent and divergent section. During the experiment, the water fed to the venture and the flow rate can be control by the gate valve at the outlet of venture.

The venture is used to demonstrate the flow rate measurement and to determine the co-efficient of discharge.

Features:

01. Self contained system
02. Simple representation of concept
03. Direct measurement of static head
04. Seven pressure tapings along with tubes
05. Requires minimal installation
06. Robust and transparent Venturimeter
07. All tanks are rust proof

Technical Specifications:

Test Section (Venture):	Throat Diameter - 12mm, Upstream Diameter - 33 mm Upstream Taper - 10° Downstream Taper - 17° MOC - Acrylic (Transparent)
Manometer	: 0 to 300 mm, Seven Tubes (Flexible & Transparent)
Reservoir Tank	: 503 ´ 300 310 mm, Capacity - 40 Liters
Overhead Tank	: 191 195 450 mm, Capacity - 16 Liters
Measuring Tank	: 290 300 251 mm, Capacity - 23 Liters
Pump	: 72 LPM, 0.5 HP, 230 V, 50 Hz
Level Indicator (Body mounted type)	: 20 cm

List of Experiments:

01. To verify Bernoulli's Theorem.
02. To observe (visually) types of flow (laminar or turbulent) and calculation of Reynolds Taper

SMD Technology Trainer

Order Code - 10924



Today's electronic gadgets & equipments are miniaturized with each passing day. In the industry it has largely replaced the previous construction method of fitting components with wire leads into holes in the circuit board (also called through-hole technology) and it has totally revolutionized the manufacturing process. Surface Mount Technology (SMT) is method for constructing electronic circuits in which the components are mounted directly onto the surface of printed circuit boards (PCBs). Electronics devices so made are called Surface Mount Devices or MSDs.

may have short pins or leads of various styles, flat contacts, a matrix of balls (BGAs), or terminations on the body of the component (passives), unlike discrete components, SMD components have a huge variety of packages (size).

SMD Technology will be the order of the day for the electronics industry in the coming years. SMD offers Small size, consequent High Packing Density, High Reliability & Improved High Frequency performance. SMD Technology Kit to keep you in pace with the technology revolution.

The user is familiarized from components their packages to soldering practice.

SMD Technology Kit Contains:

01. SMD Identification Board The user is familiarized with different SMD Components -Resistors, Capacitors, Inductors, Diodes, Transistors & IC's packages.
02. Proto BOARDS are special PCB's with readymade solder pads for various SMD components & IC's, which makes the soldering much easy. It includes Through Hole, SO, SOP, Chip Scale package Proto BOARDS.
03. SMD Soldering Jig
04. SMD Soldering Iron A Variable Temperature Controlled Soldering Iron is supplied with lead.
05. SMD components are supplied for Solder practice. Resistors, Capacitors, Diodes, Transistors
06. Tweezers: Holding & placing of SMD components.

List of Accessories :

01. SMD Identification Board with manual 1 no.
02. Proto BOARDS 2 nos each
 - Discrete Surface Mount
 - SOP
 - SO
 - Through Holes
 - Chip Scale
03. SMD Soldering Jig 1 no.
04. SMD Soldering Iron 1 no.
05. SMD components Resistors, Capacitors, Diodes, Transistors 10 no. each
06. Tweezers 2 no.
07. Manual 1 no.

Tape Recorder Trainer

Order Code - 10927



Stereo Tape Recorder Trainer is ideal equipment to teach the operation of stereo recording and stereo cassette playing function. The comprehensive study of Tape record and Mechanism unit technique is described in the operating manual. One of the main features of this trainer is fault simulation. The fault created in the trainer in no way damages the trainer.

Features:

01. Compact design
02. Fault creation and diagnosis
03. 42 Test Points

04. More than 15 faults can be demonstrated on this trainer
05. No soldering and de-soldering is required to simulate faults
06. The main IC's are provided on socket to provide a facility to check similar IC' and also to create the faults by inserting faulty IC's in the sockets
07. Test points detail with typical voltage and wave forms are provided in the manual
08. In built power supply
09. Two identical mono channels clubbed together to obtain stereo effect through stereo head Both internal and external recording facility available
10. Recording process understood through LED indicator present in equalization section
11. 8P-2W R/P switch mechanism planed widely through 16 nos 1P-2W toggle switches
12. Separate bass/treble section to understand the effect of low frequency as well as high frequency signal

Technical Specifications

Amplifier Type	: Class B amplifier
Audio Power Output	: 14 W (7 W × 2 channels)
Frequency Response	: 100 Hz to 8 KHz
Tape Speed	: 4.75 cm / sec
Erase Head	: Fix magnet
RP Head	: YBBT 62 (Stereo)
Mechanism	: R X 39
Motor	: CCW 12 V DC
Circuit Block	: Pre amplifier CH-L & CH-R Bass - Treble CH-L & CH-R Output amplifier CH-L & CH-R Equalization CH-L & CH-R Output level indicator section Power supply section
Panel Control	: Volume CH-L & CH-R Bass CH-L & CH-R Treble CH-L & CH-R
Mechanism Control	: Record, Play, Reverse, Forward, Stop, Pause
Recording Facility	: Condenser Mic and EP socket for feeding external signal
PCB Size (mm)	: 300 × 400
No. of faults	: 15
No. of Test point	: 42
Power Supply	: 220 V ± 10 %, 50 Hz / 60 Hz on request
Power Consumption	: 8.17 W (approx.)

RFID Trainer

Order Code - 10934



RFID TRAINER is an excellent learning/ training system for understanding basics, working and application of RFID (Radio Frequency Identification). It comprises of Contactless RFID Reader, 5 Mifare contactless cards, RFID Applications/Demo/Video Software. System works on 13.56 MHz and ISO 14443A read and write support. RFID is an automatic identification technique, storing and retrieving data using RFID tags or transponders. RFID tags (Active or Passive) is stuck

into a product, animal or person for identifying using radiowaves. Most RFID tags have 2 parts: Integrated circuit for storing, processing information, modulating/demodulating a RF signal and Antenna for receiving/transmission. Applications for RFID includes transport payments, product tracking, animal identification, inventory systems, human implants, libraries etc.

Features:

01. Software for understanding/working on Applications, Demo, Product Videos
02. Contactless RFID Reader at 13.56 MHz with 6cm range
03. Can be used for Active RFID tags (Optional)
04. Read/Write ISO 14443A protocol Mifare 1K memory RFID cards
05. 16 x 2 LCD Display with 89C51 Micro controller
06. On board Breadboard with 840 tie points for designing other applications
07. High Speed Transactions and flexible configurations
08. USB to Serial interface for RFID Reader
09. Parallel Interface for applications
10. Weight : 6 Kg. (Approx.)
11. Dimension : W 412 x H 150 x D310

Specifications:

Operating Frequency : 13.56 Mhz
 Protocol : ISO 14443A and Mifare 1K Tags
 Antenna/ Modulation : In built Antenna with ASK modulation

Software:

- * Software for RFID Contact less card reader with 7 applications
- * Screen Shot Videos for 7 Applications in steps
- * Live Video Demo for the complete RFID training system
- * RFID Introduction
- Operating Range : Contact less 6 cm
- Voltage & Current : 5V@80mA for Reader;
 5V @ 200 mA for LCD ;
 12V@1.5A for stepper motor

Operating Temperature: -5 to 75 oC

Applications

1. Hardware Based Experiments
 - * RFID Seven Segment Interface (Counter).
 - * RFID Stepper Motor (Two) Interface.(With Two Stepper Motor)
 - * RFID Logic Switch /LED Interface.
 - * RFID LCD Interface.
 - * RFID Breadboard Interface.
2. Software Based Experiments
 - * Alarm
 - * Database
 - * Calculator
 - * Read/Write Block

Accessories:

01. Mifare RFID cards -----5
02. Software CD -----4
03. Mains Cord -----1
04. 25 Pin Parallel Male-Female Cable ----- 1
05. 9 Pin Parallel Male-Female Cable -----1
06. Instruction Manual -----1
07. Patch Cord 2mm to 1mm 35cm Red & Black each5
08. Patch Cord 2mm to 1mm 15cm Red & Black each5

Elevator Training Set

Order Code - 10935



1. Overview

"DLPLC - DT1 elevator training set" is professional PLC control training object which designed for vocational and technical education, higher education, designed for "programmable logic controller technology" and "programmable logic controller principle and its application", "maintenance electrician", "PLC application technology", "PLC principle and application " course in the colleges and universities This device is suitable for PLC (programmable logic controller) learning and application training, students' pre-job training and worker retraining in senior vocational colleges and universities, higher institutions, not only can meet PLC experiment teaching and related courses design and assessment requirements of universities and colleges, vocational schools, but also can be used as engineering and technical personnel training equipment.

2. The system function

The elevator training device is composed of floor, car, stroke limit institutions, call light, car door, control panel, control motor, sensor, actuator, etc. can collect all kinds of signals, such as inner-choose button signal, outer-choose button signal, floor limit signal, elevator threshold signal, can realize the logic control; Be able to do two groups of car elevator and the elevator door switch control, and can combine experiment; Have up and down and open-close door hardware power-off protection function, effectively avoid motor offside operation fault; Through the content of the project, project analysis, project implementation, project summary and ability evaluation, complete the basic skills, professional skills and post skills.

3. System feature

01. It is composed of the floor, has car, stroke limit institutions, call light, car door, control panel, control motor, sensor, actuator, etc.
02. Electrical aspects is composed of dc reducer motor and sensors, limit switch, light,etc.
03. This system uses the computer simulation modern information technology means, through the operation, simulation, simulation, three training level, solves the professional training theory, experiment, practice and actual application disjointed problem.
04. Configure configuration software, and provide application guidance and application engineering example.
05. Easy to learn: supporting help to learn software material library. Supporting educational software, electronic materials, material database software, project teaching software, industry simulation software, etc. series of teaching software upgrading.
06. Easy to teach: use the project teaching method combining with the teaching case. Supporting higher

higher education publishing multimedia electronic teaching material, multimedia electronic teaching plan production platform and project teaching software, make the teacher's experiment teaching and theoretical teaching easier

07. Protection function: with lifting and on hardware power-off protection function, effectively avoid motor offside operation failure.

4. System technical parameter

- 01. Power input: 4 v dc power supply
- 02. Working environment: -100C ~ 400C
- 03. Training platform
- 04. Physical size: 600 * 400 * 1000 (length * width * height)
- 05. The training content
- 06. Open and close door control test
- 07. Lifting inner two floor choose up and down, the open and close door control test`
- 08. Inner three floor choose up and down control test
- 09. Inner four floor choose lift control test
- 10. Outer three floor call lift control test
- 11. Outer three floor call lifting and open and close door control test
- 12. Outer four floor lift control test
- 13. Three Floor elevator comprehensive control test
- 14. Four elevator integrated control experiment and project practice.

5. Configuration lists

- 01. **Training Platform Base** Sheet metal structure, the appearance of spray processing base have regulator, and ensure the smooth degree **1 Set**
- 02. **Four layers elevator control system 1 Set**
- 03. **The connecting line** Fully meet the experiment line connection need **1 Set**
- 04. Accessories and spare parts Meet fixed element, connecting line need **1 Set**
- 05. Software and data Equipment related software and instructions **1 Set**

Three Level Elevator Training Set

Order Code - 10936



. Overview

This set can truly simulate elevator working condition. It can complete lift go up and down, open and close door. The set is composed by working portion, control portion and PC interface. The working porting including various industrial gearing and sensor. It well simulate elevator open closed structure. The control portion have three control method (PLC,MCU and PC)to complete control operation.

The set auto un controlled by MCU. Starting control button which on interface panel to control elevator. Additionally, the set can connect with PLC to control elevator. Rotating change-over witch SA1 to change control method (MCU, PLC or PC).

This set install PC monitor which can direct monitoring elevator running on PC.

This set is composed by aluminium training platform, car platform sill, signal transfer part and building show

parts

2. Parameter

- 01. Working pressure: DC24V
- 02. Temperature: -100C ~ 400C; Humidity: £ 90% (250C).
- 03. Total capacity: £1KVA

3. Description

01. This set including DC motor, Car platform sill operation section, Digital tube display section, Sensor training section.

The system is modular open structure training platform. You can use different brand PLC or add other training modular as required.

02. The elevator Training set is composed by baseboard, on down car platform sill, stroke limited position institution, call indicate light, car gate, control panel, control motor, sensor and transmission gear. It can collect all signal such as inner choose button signal, outer choose button signal, floor spacing signal ,elvator door spacing signal which complete logic control ,control of lift car up and down also elevator open and close.

Additionally, Power off protection of the open and close can avoid motor offside operating.

03. This system use PC simulation technic by operating and simulating settled some pratical problems.

04. With configuration software an offer application guidance and application samples.

05. Easy to learn with software, soft teaching materials, material database software and so on.

06. Easy to teach : project and didactic combined .Multi-media and practic software made experiment teaching and theory teaching easy.

Protection: Avoid offside Operating by power-off protection.

4. Training Contents.

- 01. Open and close control experiment
- 02. Second floors inside choose up and down,open close control experiment.
- 03. Thirds floors inside choose up and down control experiment
- 04. Third floors outer call up and down, open and close control experiment.
- 05. Third floors elevator comprehensive control experiment
- 06. PLC control experiment
- 07. MCU control experiment
- 08. PC software control experiment

5. Main part list

Name	Material	Qty.
Training Platform	Aluminium alloy structure	1 Set
Car platform	-	1 Set
Floor show	Digital tube display	1 Set
Button	Blue	1 Set
Car gate	Dark Brown Acrylic Sheet	1 Set
Signal change over parts	K4 Terminal	1 Set
Connection Cable	-	1 Set
Control mode transition switch	-	1 PC
Testing line	-	1 Set
Case Procedure	CD	1 PC
Instruction Book	-	1 Set

LED Television Trainer

Order Code - 10937



10937 Understanding LED Television is a friendly training platform to learn the operation of LED Television receiver. It is demonstrator cum training system specifically designed for the comprehensive practical study on LED TV engineering for the beginners with a basic knowledge of the various electronic building blocks and fundamentals of communication system.

This didactic product develops the sense of investigation within the student and familiarises him with repair/design techniques. One of the main features of this training system is fault simulation to educate on actual fault finding, by simulating faults on this platform. The complete block diagram of LED TV system is printed on the mimic. Finally this equipment allows us to do experiments and to observe waveforms/signals/voltages of different sections, which are guided thoroughly by theory and product tutorials to gain indepth knowledge of the system.

Features:

01. Superior quality 20-inch full HD LED Color Television/ PC Monitor
02. Manual and Remote control operation
03. PAL/ NTSC video formats
04. Composite video input/ VGA input
05. Complete block diagram of a LED TV system on-board
06. The different circuit sections of LED TV are exposed on a PCB
07. Easy identification of different parts and components of the system at a glance
08. Easy measurement of voltages and observation of waveforms on test points
09. Soldering free fault creation and troubleshooting
10. Online Product Tutorial
11. 1 Year Warranty

Technical Specifications:

Display

Display Type	: LED, HD
Screen Size	: 20 Inch (50cm)
Display Resolution	: 1600 X 900 pixels
Contrast Ratio	: Mega Contrast Ratio
Display Color	: 16.7 Million Display Colors
Viewing Angle	: 170 (H) X 170 (V)
Refresh Rate	: 50 Hz
Video Interface	: Video Input/ VGA input
Audio Interface	: RCAL&R
Audio Output Power	: 8WX2
Receiving System	: PAL BG/I/DK and NTSC
Channel Coverage	: VHF-2-12; UHF21-69; CATV (X~Z+2, S11S41)
Antenna Impedance	: 75W Unbalanced
Application	: Color Television/ PC Monitor Connectivity
USB	: 1 X USB 2.0 (MPEG, JPEG, MP3)
HDMI	: Yes (1 X HDMI)
Other Connectivity	: RF In, AV In, Ypbpr In, VGA In, VGA Audio In, AV out

Composite A/V	: Yes
Component Video	: Yes
Analog Audio	: Yes
Test Points	: 55 nos
Switched Faults	: 50 nos
Remote Battery	: UM-4, "AAA" 1.5V (2 nos)
Mains Supply	: 110-260V AC \pm 10%, 50/60Hz
Power Consumption	: 35W
Weight	: 11 Kg (approximately)
Dimension	: W430 X D252 X H82
Included Accessories:	Remote, Mains cord, 34 Pin FRC cable, 15 Pin D type cable each 1 no.

Experiments:

01. Study the specifications of full HD LED Television
02. Study the block diagram and operating principle of LED TV
03. Study the functions of front panel controls/ keys of LED TV
04. Study the functions of controls on Remote
05. Study of circuit description and functions of different sections
06. Study and observation of waveforms/signals of different sections
07. Study and measurement of voltages of different sections
08. Study of switch faults and troubleshooting in different sections

GSM Mobile Trainer Kit

Order Code - 10939



Order Code : 10939 GSM Mobile Trainer Kit is an easy medium of learning the fundamental concept of Mobile communication like GSM, GPRS. The main focus of MCLS is in opening up a whole new world for you, mobile communication concepts like Call setup, call forward, SMS, voice, data and other Network protocols are also experimented on vis-à-vis the existing environment.

Features:

01. Remote control by AT commands (GSM 07.07 and 7.05)
02. Baud rate from 300 to 115,200 bits/s, Auto baud. Various LED indicators for POWER, Network, Low battery, Battery charging & Battery status & serial Communications, Battery temp. indication etc.
03. Provision for auxiliary audio MIC & speaker connect.
04. Appropriate test points at various stages.
05. Specific digital inputs to allow direct SMS transmission if any input changes state.
06. Relay output controlled over SMS.

Specifications:

- * Dual band 900 / 1800 MHz GSM / GPRS Modem.
- * Data, SMS, Voice.
- * Onboard RS-232 & USB connector for PC Communication.
- * 20 Membrane keys with multifunctional operation.
- * GLCD 128x64 for display.

- * On board RTC with independent battery backup.
- * Onboard Mic and Speaker interface.
- * SMA antenna connector with antenna.
- * Sliding / fixed landing SIM holder (3.3V/5V SIM interf.)
- * Remote control by AT commands (according to GSM 07.07 and GSM 07.05)
- * Maximum output power 2W for GSM 900: 1W for GSM 1800.
- * Bare board Tested Glass Epoxy SMOBC PCB is used.
- * In-Built SMPS of +12V/2A.
- * Attractive wooden enclosures.
- * User's Manual .

Experiments:

01. SIM identification for getting self number, network name etc.
02. Execution of AT commands via PC.
03. Voice communication using AT commands.
04. Study of text or PDU data formats & interface with modem SMS.
05. Network status intimation via AT commands.
06. Read Message Delete Message on PC.
07. Call Records a. View missed calls b. View dialed numbers c. View records on PC.
08. Contacts - a. Dial no. b. Delete Contact c. Add contact.
09. Study and measure PWM signal of circuit such as Vibrator, LED, Buzzer.
10. Setting of MIC gain & Speaker gain via. AT commands.
11. SMS interface for Transmit, Receive & manage inbox.
12. Send SMS messages with the help of on board keypad.
13. Indication of battery temperature via AT commands.
14. On board Li-ion battery with provision to start, stop battery charging via AT commands.
15. Know & manage information for all recent calls, missed calls.
16. Manage contact list.
17. Send and receive email facility through AT commands.
18. Relay output controlled over SMS.

Bluetooth Wireless Technology Trainer

Order Code - 10940



Features:

01. Trainer offers comprehensive experiment set up explaining Bluetooth & Zigbee Protocols.
02. Either my buy shared set up with replaceable NICs or independent setup of nodes for each technology. However NICs could be replaced in one setup to experiment with other.
03. Table top setup made using light but sturdy Aluminum profile (4X2) Rack.
04. Lab PC with serial / USB port required for network

monitoring or ot work as user, PC not in scope of supply.

05. Set of Users Guides provided with each unit.

Technical Specification:

- * Operating Freq. Band ISM 2.4Hz 2.48GHz
- * Modulation Method : Gaussian Freq. Shift Keying
- Output
- * Output Interface: UART
- * Serial UART speed up to 921 .6kbps
- * Bluetooth Specification : v2.0+EDR
- * Transmit Power Max. 18dBm
- * Receiving Sensitivity : 30dBm (0.1%BER)
- * Compact size 27.5 X 30.0 X 14.0 (mm)
- * Provdes transparent RS232 serial cable replacement
- * Support up to 4 multiple simultaneous connection
- * Profile : Serial Port Profile
- * Working Distance : Normally 100meters
- * RSSI Indication on LED
- * **Nodes:** 4 embedded Nodes with 4 replaceable NICs for each technology kept under transparent cover.
- * **Node Hardware:** A) Embedded Controller device: 89C668 operating @ 16MHz. On chip RAM: 8KB, Flash/EEPROM:64KB. B) Serialport (RS232C) 9pin D (M). C) In built USB to serial converter. D) Display: 20X4LED (Backlit). E) General Purpose SMD bicolor (green, red) 8X2LEDs & 8 SMD push button switches/DIP switches. F) Power (SMPS): 5V/2.5Amp SMPS with RCA plug. SMPS. ACI/P230Vac+/-10%/50Hz X 4Nos.
- * **Node Software:** mbedded program written in C for Bluetooth.
- * **Network Interface card:** Bluetooth application module mounted on adaptor PCB 4 Nos
- * **PC Software:** Network Monitor
- * **Experiment topics Software:** Configuring Master & Slave. Data exchange from one device to other. Select device name & transmit key, led. status messages to be observed LED.
- * **Dimension:** 900mm(L) X 300mm (W) X 720mm (H)
- * **Weight:** 20Kg

Zigbee Wireless Technology Trainer

Order Code - 10941



Features:

01. Trainer offers comprehensive experiment set up explaining Bluetooth & Zigbee Protocols.
02. Either my buy shared set up with replaceable NICs or independent setup of nodes for each technology. However NICs could be replaced in one setup to experiment with other.
03. Table top setup made using light but sturdy Aluminum profile (4X2) Rack.
04. Lab PC with serial / USB port required for network

- supply.
05. Set of Users Guides provided with each unit.

Technical Specification:

- * Operating Freq. Band ISM 2.4GHz
- * Indoor/Urban : Up to 133` (400m)
- * Outdoor line-of- sight : up to 400` (120m)
- * Transmit Power : 2mW (+3dBm)
- * Receiver Sensitivity: 95dBm RF Fata Rate:250,000bps
- * TX Current: 40mA(@3.3V)
- * RX Current : 40mA (@3.3V)
- * Power
- * Each direct sequence channel has over 65,000 unique network addresses available Point to-Point, Point or multipoint and peer to- peer topologies supported Self Routing, self -healing And fault-tolerant mesh networking
- * RSSI Indication on LED
- * **Nodes:** 4 embedded Nodes with 4 replaceable NICs for each technology kept under transparent cover.
- * **Node Hardware:** A) Embedded Controller device: 89C668 operating @ 16MHz. On chip RAM: 8KB, Flash/EEPROM:64KB. B) Serialport (RS232C) 9pin D (M). C) In built USB to serial converter. D) Display: 20X4LED (Backlit). E) General Purpose SMD bicolor (green, red) 8X2LEDs & 8 SMD push button switches/DIP switches. F) Power (SMPS): 5V/2.5Amp SMPS with RCA plug. SMPS. ACI/P230Vac+/-10%/50Hz X 4Nos.
- * **Node Software:** mbedded program written in C for Zigbee protocol.
- * **Network Interface card: Zigbee** application module mounted on adaptor PCB 4 Nos
- * **PC Software:** Network Monitor, X CTU Software
- * **Experiment topics Software:** Configuring Coordinator & End Devices. Data exchange from one device to all connected in network. Observe text message, led status, frequency/temperature display.
- * **Dimension:** 900mm(L) X 300mm (W) X 720mm (H)
- * **Weight:** 20Kg

Local Area Network Trainer

Order Code - 10942



Features:

01. It offers comprehensive experiment set up explaining various physical topology of LAN viz; Token Ring, Token Bus, Ethernet (CSMA/CD), Modbus etc. & variety of TCP, IP, HTTP, SMTP, wireless LAN (802.11) etc. Protocol demonstrator through error generation facility sans socket programming.
02. Set of Users Guide provided with each unit.
03. Table top setup made using light but sturdy aluminum profile (4X2) Rack complete with cables

connectors, Optionally external USB to RS232 Converter is Provided.

04. One PC with serial required for monitoring or as user not in scope of supply.
05. Useful for post Graduate projects and research purpose.

For More Details Visit Our New Website www.tesca.in

Printer / Scanner / FAX / Phone Trainer

Order Code - 10943



Features:

01. Various components of the printer are made accessible to the students by spreading out on a cuboid demo rack made from aluminum profile
02. Non-destructive simulated faults have been implemented through slider switches located on Fault Panel to teach section wise faults & their troubleshooting
03. When not in use Printer trainer may be used as a USB port based regular Lab printer / scanner machine.
04. Set of Instructor Guide and Student workbook provided with each unit.

Technical Specification:

Enclosure / accessories

Aluminum profile based cuboid demo rack.

Mechanical Size 650 (L) X 650 (W) X 600 (H) mm,
Weight 20 kg.

Number of panels & Their function (No. of fault switch)

PFP1: Fault simulator panel for printer/scanner .fax/copy/phone/USB, (24 Slide switches)

PFP2: Power Supply Panel.

Number of Faults 24

List of Faults

Printer Section Faults: 1) Roller Motor 2) Carriage Motor 3) Paper Mismatch 4) Paper Jam 5) Out of paper 6) Encoder supply 7) Cartridge Position Sensor 8) Cartridge Door open

Scanner/Fax/Copy Section Faults: 1) Scanbus 2) Scanner Supply 3) Scanner motor 4) Scan/Copy/ fax/paper and sensor 5) Scanner inlet paper sensor

Keyboard Display Section Faults: 1) Loose connection in LED connector / wiring 2) Display supply fault 3) Display section OFF

Power Supply Section Faults: 1) 30V supply 2)15Vsupply

Telephone Handset Section Faults: 1) Speaker 2) MIC

Telephone Line Section Faults: 1) Line

USB Section Faults: 1) USB supply 2) USB Data Line [D-] 3) USB Data Line [D+]

Printer/Fax/Scanner/Copy/ Telephone Specifications

Subject to change as newer & high speed models appear in market. Technical Specification Fax Type: Plain paper , Printing Technology: Ink-jet - Color, Monthly Duty Cycle: Max, 1500 impressions, Language settable from LCD Memory: Max Standard Memory

16.0MB

Copying:

01. Max copying speed: 20.0ppm (mono)/14.0ppm (color)
02. Max copying resolution: 600dpi (mono) / 4800 X 1200 Dpi (color)
03. Maximum copies = 100.0

Printing:

01. Inkjet Technology : HP Thermal Inkjet
02. Max .Print. Resolution: 1200 X 1200dpi (mono) / 4800 X 1200 dpi (color)
03. Max Printing speed up to 20.0 ppm (mono) / up to 14.0 ppm (color)
04. Printer Drivers/ Emulations LIDIL

Scanning:

01. Optical Resolution : 1200 X 1200 dpi
02. Interpolated Resolution : 19200dpi
03. Color Depth 48.0bit

Fax Machine:

01. Max Transmission Speed: 33.6Kbps
02. Fax Resolution: 300 X 300dpi
03. Total Memory capacity : 200.0 pages

Fax Machine Features:

01. Broadcast Transmission: 48 stations
02. Delayed Transmission: Yes 3) Features : Automatic redialing

Power Supply: 110/230VAC/18 Watt, needs external Wall transformer supplying of DC power supplies

LED TV Trainer

Order Code - 10944

10944 is a LCD/LED Colour TV Trainer is an ideal training equipment to teach the operation of LCD/LED colour TV receivers. The complete Block of LCD/LED TV Receiver is printed on single PCB for easy understanding of function of different blocks. Test points allow the analysis and monitoring of the signals in different sections. By using the fault simulation method, it is possible to introduce the most common breakdown and their rectification.



Specifications:

- * Display : 22" Diagonal Size , Flat panel LCD/LED display
 - Max Resolution : 1280 x 1024
 - Aspect Ratio : 4:3
- * Image
 - Brightness : 300 cd/m²
 - Contrast Ratio : 350:1
 - Max H-View Angle : 160
 - Max V-View Angle : 160
- * Interface
 - Analog Video Input : RGB VGA (HD-15)
 - Analog Video Input : S-Video
 - Composite Video Input : RCA Yellow,
 - Audio Input : RCA- Left (White), Right (Red)
 - Antenna RF Input : RF - SDTV/PAL
- * Tuner Channels : 2 to 69
- * Screen display : Volume, Brightness, Contrast, Color, Channel, Tuning
- * Remote Control functions : On screen display of Volume, Brightness, Contrast, Channel
- * Audio Amplifier : 3WPMPO
- * All interconnections are made using 2mm socket.

- * Test points are provided to analyze signals at various points.
- * 8 no's of Fault Switches Provided
- * All ICS are mounted on IC Sockets.
- * Bare board Tested Glass Epoxy SMOBC PCB with Block Diagram.
- * Attractive Metal Enclosure
- * User Manual for Experiments

Experiments:

01. To Study Specifications of HDTV.
02. To Study the Block Diagram and working principle
03. To Study Input/output signals of different sections
04. To Study Complete circuit with different sections
05. To Study Remote Section
06. To understand/observe the function of external and Internal controls
07. To measure Test Point Voltages for different sections.
08. To observe Test Point Waveforms for different sections
09. To measure Video and Audio gain (sensitivity) with Pattern Generator
10. To demonstrate and understand different types of faults
11. To study faults diagnosis method
12. To study ICs used in HDTV

SMPS Trainer Board

Order Code - 10945



10945 Trainer is a very versatile training system, has been designed to explain a switching based Switch Power Supply. The product is designed keeping in mind that a student can understand each block of SMPS in a very easy way. Various test points have been provided so that one can check inputs and outputs of each block contained. Being different from a conventional block diagram internal structure of blocks is also shown. Switching Transformer is presented in such a way that a student can readily understand its functioning and pin configuration. Test points allow the analysis and monitoring of the signals in different sections. By using the fault simulation method, it is possible to introduce the most common breakdown and their rectification.

Specifications:

- * Input : 80 to 230 V AC $\pm 10\%$, 50 Hz
- * Outputs : +12 V DC regulated, -12 V DC regulated, +5 V DC regulated
- * Switching Transformer Input : 320 V DC switching at 132Khz
- * Fuse : 2A
- * Load provided for testing the DC outputs
- * Variac Is also Provided as optional for Input Voltage
- * All interconnections are made using 2mm socket.
- * Test points are provided to analyze signals at various points.
- * Circuit Diagram provided on the front panel.
- * Bare board Tested Glass Epoxy SMOBC PCB with Block Diagram.
- * Attractive ABS Plastic Enclosure.
- * User Manual for Experiments.

Experiments:

01. Study of Switching Transformer.
02. Study of PWM switching device.
03. Study of Optocoupler.
04. Study of Regulation.
05. Study of SMPS with Variac input (Optional)

SMPS Trainer Board

Order Code - 10946



EPABX Trainer is a Microprocessor based system designed to help the students to understand the basic concept and working of a Telephone Exchange. All the components are mounted on a single PCB in functional blocks and have various Test points to monitor all kinds of telephonic signals.

Features:

01. Non-Blocking type tone dialling,
02. Distinctive Ringing,
03. DTMF/ Pulse Dialing, Music on hold,
04. Line Status Indication on the Exchange,
05. Executive Telephone with special features,
06. Control methods,
07. Abbreviated Dialing,
08. Automatic Call Back,
09. Barge-in-with/ without tone,
10. Call camp-on, Call Parking,
11. Call Pick-up, Call Restriction,
12. Call transfer,
13. Call Forwarding,
14. Follow me,
15. Conference 4-Party,
16. Direct outward dialing,
17. Do not Disturb,
18. Extension Privacy,
19. Extension to Extension Call,
20. Hotline on Extension,
21. Hunting Group,
22. Last Number Redial,
23. Selective Trunk Line Access,
24. Simultaneous Ringing,
25. Wake up Alarm/ Reminder Call.

Specification

No. of Subscribers	: Two DOT Lines, Four Extension Lines
Line Section	: Opto Isolation for Trunk Lines and 4 Extension Lines.
Tone Generation	: Dial Tone, Busy Tone, Ring Back Tone, Hold-on music etc.
CPU Section	: 89E516RD Microcontroller based stored program control.
Memory	: 72KB Program memory, 1KB RAM.
Speech Path	: Fully Non- Blocking.
Loop Resistance	
- Extension	: 600 Ohms.
- Co-line	: 1200 Ohms.
Cross Talk Attenuator	: >70dBm.
Idle Channel Voice	: >70 dBm.
Insertion Loss	: Extension to Extension not

	Less than 60 dBm.
	Extension to DOT Line not Less than 60 dBm.
Dial Pulse Ratio	: 10pps +/-, 10%
Input Power	: 230V AC, 50Hz.
Longitudinal Balance	: 60dBm.
Switch Faults	: 8 Switch Faults are provided on board to study different effects on circuit.
Test Points	: 46 Nos.
Power Requirement	: +11V, +23V, +5V, +15V.

Optional

Telephone set : 4 Nos.

Refrigeration & AC Trainer

Order Code - 10947



Technical Specification:

Aluminum profile sturdy flat panel (table top) system, carrying various high voltage components housed in plastic enclosures (panel) to minimise shock possibility.

Instrumentation Power supply cum Multichannel DPM panel

- * $\pm 12V/500 \text{ mA}$, $+5V/300\text{mA}$, Unregulated 17V dc/750 mA, line Synchronizing signal, 13V / 3 Amp.
- * Multi channel DPM for digital display of process parameters.
- * 20pin FRC power bus to supply power to neighbouring panels.

Computer Interface panel (CIP)

- * Connects to PC (P4XP) parallel port through 25 pin M to F cable / 1.5mtr.
- * 4 ADC channels I/P : 0 to 2.5V FS with 1no input simulation pot. 1 DAC channel O/P 2.5V FS.
- * V to I function block: I/P 0 to 2.5V & O/P 0-20 or 4-20mA (100W load) switch settable.
- * I to V function block : I/P 4 to 20 mA & O/P 0-2.5V
- * USB Converter to interface 25 pin D connector on CIP panel to USB using PLC 18F microcontroller 28 pin SOIC enclosed in 25 Pin D shell using Type A to mini B cable.
- * Optionally hardware module of square root extractor is provided so that PLC / Panel mount PID may be interfaced.

Evaporator:

An Evaporator is used in an air-conditioning system to allow a compressed cooling chemical, Such as R-22 (Freon) or 134a, to evaporate from liquid to gas while absorbing heat in the process It can also be used to remove water or other liquids from mixtures. The process of evaporation is widely used to concentrate foods and chemicals as well as salvage solvents. In the concentration process, the goal of evaporation is to vaporize most of the water from solution which contains the desired product. In the case of desalination of sea water or in Zero Liquid **Size:** 605 (L) X 200 (W) X (H)

Pressure Temperature sensor panel:

- * Support 7 independent blocks of signal condition circuits for temperature sensors to generate output 0-2.5 VCD (FS).
- * Span/zero adjustment amplifier.

Condenser:

Condenser is a device or unit to condense a substance from its gaseous to its liquid state, typically by cooling it. In so doing, the latent heat is given up by the substance, and will transfer to the condenser coolant. Condensers are typically heat exchangers which have various designs and come in many sizes ranging from rather small (hand-held) to very large industrial-scale units used in plant processes. For extracted from the interior of the unit to the outside air. Condensers are used in air conditioning, industrial chemical processes such as distillation, steam power plants and other heat-exchange systems. **Size** : 330 (L) X 105(W) X 250 (H)

Accumulator :

The accumulator use nitrogen to keep the hydraulic fluid pressurized. When the fluid is pumped into an accumulator the nitrogen (N₂) inside the accumulator is compressed. When all the hydraulic fluid is in an accumulator designed for high pressure side of an HHV, the pressure of the nitrogen reaches 5000 pounds per square inch (psi). If empty of fluid, the pressure of the nitrogen is about 2000(psi). The pressure of the nitrogen in the low pressure reservoir will vary from 60 psi when empty to 200 psi when full.

Mechanical Dimension (mm):

1170 (L) X 300 (W) X 990 (H) ·

Net Weight : 110 kg

Digital Satellite Receiver Trainer

Order Code - 10948

10948 is a versatile platform useful for students to learn the concept of DTH and its troubleshooting. Kitek DTH Trainer is housed in an elegant cabinet with proper block diagram with fault creating and troubleshooting facility to understand the working of DTH. DTH (Direct to Home) is a satellite-aided TV rebroadcast system, featuring a compressed digital encoded signal for unlink/downlink. Today most satellite TV customers in developed television market get their programming through a Direct Broadcast Satellite (DSB) provider, such as Doordarshan DTH platform. The provider selects programs and broadcast them to subscribers as an attractive package. Unlike earlier, the provider's broadcast is completely digital, which means it has high picture and stereo sound quality.



Technical Specifications:

RF Input	: 950-2150 MHz
Input Impedance	: 75 Ohm
RF Output	: 470 MHz to 862 MHz (approx)
Dish Input	: F-Connector
Composite Video Output	: RCA type
Audio Output	: RCA type (L/R)

TV Output	: RCA type
Video Output	: PAL/NTSC
IF Frequency Bandwidth	: 27MHz- 36MHz
Video Output level	: 1Vpp (75 load)
Image Resolution	: 352 x 288
Controls	: Power, Menu, Channel Up / Down OK, Left, Right
Test Points	: 17 nos.
Power Supply	: 110V - 260V AC, 50Hz/60Hz
Included Accessories	: Mains Cord, Remote, RF Cable
Audio/Video Card, Dish Antenna with accessories, LNB	
Pencil Cell	: 2 nos.
Dish Connecting wire	: 10 meter (approx)
Monitor	: 15 inch

Experiments:

01. Introduction and basics of DTH System
02. Understanding various components of DTH receiver system
03. Study of various blocks of DTH system
04. Study of working principle of DTH system
05. Various types of fault creation and Troubleshooting

Laser Printer Trainer

Order Code - 10949



10949 trainer is a very versatile training system, has been designed to explain Laser Printer hardware and its troubleshooting. Various test points have been provided so that one can check inputs and outputs of each block contained. Being different from a conventional block diagram internal structure of blocks is also shown. Test points allow the analysis and monitoring of the signals in different sections.

Technical Specifications:

- * ARM-9 Processor 300 MHz
- * Memory 8 MB
- * Interface Hi-Speed USB 2.0
- * Engine Speed Simplex Up to 20 ppm in A4 (21 ppm in Letter)
- * Duplex Manual Duplex
- * Warm-up time From Sleep Less than 30 seconds
- * FPOT From Ready Less than 8.5 seconds
- * From Sleep Less than 15.5 seconds
- * Resolution Up to 1,200 x 1,200 dpi effective output
- * Standard Capacity 150-sheet Multi Purpose Tray @ 80 g/m²
- * Max. Capacity 150-sheet @ 80 g/m²
- * Printing:
 - Max. Size 216 x 356mm (8.5" x 14.02") - Min. Size 76 x 183 mm (3.0" x 7.2")
- * Multi-purpose Tray (Bin type) Capacity - Plain Paper : 150 sheets @ 80 g/m² - Envelop : 1 sheet @ 80 g/m²
- * Media sizes A4, A5, Letter, Legal, Executive, Folio, Oficio, ISO B5, JIS B5, Envelope(Monarch, No.10, DL, C5), Custom Media type Plain, Thin, Cotton, Recycled, Archive, Colored, Pre-Printed, Label, Bond, Thick, Envelopes, Cardstock
- * Media weight 16~43 lb (60 to 163 g/m²)
- * Output Stacking Capacity

- Face-Down : 100 sheets @ 80 g/m²
- * Average Cartridge Yield 1500 standard pages
- * Fault creating facilities for CRUM, Thermistor, Stepper Motor, Pickup Clutch, Feed Sensor, Width Sensor, Power Switch, Printer Switch, Printer Door.
- * 17 Fault Switch with 21 Test Points provided on-board.
- * Led indicators provided on the LPT-01 PCB for sensing Power, Error, Ready, Toner and Power On, Print Switch.
- * Laser Printer block diagram is provided on LPT-01 glass epoxy PCB for understanding the logic.
- * LPT-01 Enclosed in ABS Plastic enclosure.
- * Power rating AC 220 - 240 V
- * Power Consumption Average operating mode Less than 230 W

Experiments:

01. Study of Laser Printer based on ARM-9 Processor
02. To understand the overall functioning of Laser Printer
03. Study the section of Laser Printer
- 04 To identify different faults CRUM, Thermistor, Stepper Motor, Pickup Clutch, Feed Sensor, Width Sensor, Power Switch, Printer Switch and to study the troubleshooting in Laser Printer

Copier, Scanner, Laser Printer Trainer

Order Code - 10950



10950 trainer is a very versatile training system, has been designed to explain 3 in 1 Laser Printer hardware and its trouble shooting. Various test points have been provided so that one can check inputs and outputs of each block contained. Being different from a conventional block diagram internal structure of blocks is also shown. Test points allow the analysis and monitoring of the signals in different sections.

Technical Specifications:

- * Inteface Hi-Speed USB 2.0
- * Engine Speed Simplex Up to 20 ppm in A4 (21 ppm in Letter) Duplex Manual Duplex
- * Warm-up time From Sleep Less than 30 seconds
- * FPOT From Ready Less than 8.5 seconds
- * From Sleep Less than 15.5 seconds
- * Resolution Up to 1,200 x 1,200 dpi effective output

Copier Specification:

- * Copy Speed Simplex to Simplex Up to 20 ppm in A4 (21 ppm in Letter)
- * FCOT (B&W) From Ready Less than 14 seconds (from platen)
- * Copy Resolution Text
 - Scan: 300 x 300 dpi , Printing : 600 x 600 dpi @ ADF
 - Scan: 600 x 300 dpi , Printing : 600 x 600 dpi @ Platen Text/Photo
 - Scan: 300 x 300 dpi , Printing : 600 x 600 dpi @ ADF
 - Scan : 600 x 300 dpi , Printing : 600 x 600 dpi @ Platen Photo
 - Scan: 600 x 300 dpi , Printing : 600 x 600 dpi @ ADF

- Scan: 600 x 600 dpi , Printing : 600 x 600 dpi @ Platen
- * Original Type Factory Default Text/Photo
- * Max. Original Platen A4
- * Size ADF Legal (8.5" x 14")
- * Multi Copy 1~99

Scan Specification:

Scan Method Color CIS

Compatibility TWAIN, WIA

- * Scan Speed:
 - Linearity, Halftone 15 sec on Platen, 15 sec on ADF @ 300dpi
 - Gray 23 sec on Platen, 26 sec on ADF @ 300dpi
- * Color
 - 256 Color 300 dpi : 65 sec on Platen, 70 sec on ADF
 - True Color 300 dpi : 70 sec on Platen, 70 sec on ADF
- * Resolution:
 - Optical 1,200 x 1,200 dpi
 - Enhanced 4,800 x 4,800 dpi
 - Halftone 256 levels
- * Scan Size:
 - Max. Document Width Max. 216 mm (8.5")
 - Effective Scan Width Max. 208 mm (8.2")
- * Max. Document Length
 - ADF : 356 mm (14") P
 - Platen : 297 mm (11.7")
- * Effective Scan Length
 - ADF : 348 mm (13.7")
 - Platen : 289 mm (11.4")
- * Scan Depth:
 - Color Internal: 16 bit x 3, External : 8 bit x 3 Mono
 - 1 bit for Lineart & Halftone
 - 8 bits for Gray scale
- * ADF Capacity 40 sheets @ 75 gsm
- * Document Size
 - Width : 142 ~ 216 mm
 - Length : 148 ~ 356 mm
- * Standard Capacity 150-sheet Multi Purpose Tray @ 80 g/m²
- * Max. Capacity 150-sheet @ 80 g/m²
- * Printing:
 - Max. Size 216 x 356mm (8.5" x 14.02")
 - Min. Size 76 x 183 mm (3.0" x 7.2")
- * Multi-purpose Tray (Bin type) Capacity
 - Plain Paper : 150 sheets @ 80 g/m²
 - Envelop : 1 sheet @ 80 g/m²
- * Media sizes A4, A5, Letter, Legal, Executive, Folio, Oficio, ISO B5, JIS B5, Envelope(Monarch, No.10, DL, C5), Custom Media type Plain ,Thin, Cotton, Recycled, Archive, Colored, Pre-Printed, Label, Bond, Thick, Envelopes, Cardstock
- * Media weight 16~43 lb (60 to 163 g/m²)
- * Output Stacking Capacity
 - Face-Down : 100 sheets @ 80 g/m²
- * Average Cartridge Yield 1500 standard pages
- * Fault creating facilities for CRUM, Thermistor, Stepper Motor, Pickup Clutch, Feed Sensor, Width Sensor, Scanner Stepper Motor, Scanner Sensor, Printer Door.
- * 21 Fault Switch with 25 Test Points provided on-board.
- * Led indicators provided for sensing Power, Error, Ready, Toner and Power On, Print Switch.
- * Laser Printer block diagram is provided on LPT-02 glass epoxy PCB for understanding the logic.

- * LPT-02 Enclosed in ABS Plastic enclosure.
- * Power rating AC 220 - 240 V
- * Power Consumption Average operating mode Less than 230 W

Experiments

01. Study of Laser Printer based on ARM-11 Processor
02. To understand the overall functioning of Copy, Scan, Laser Printer
03. Study the section of Copy, Scan, Laser Printer
04. To identify different faults CRUM, Thermistor, Stepper Motor, Pickup Clutch, Feed Sensor, Width Sensor, Scanner Stepper Motor, Scanner Sensor and to study the troubleshooting in Laser Printer

Washing Machine Trainer

Order Code - 10951



Features:

01. The Different circuit boards of Washing Machine are exposed on a PCB
02. Troubleshooting and fault finding procedure explained in details
03. Artificial fault creation facilities are provided by the switches
04. About more than 10 faults can be demonstrated at a glance
05. Easy measurement of voltage and observation of waveforms
06. The typical voltages and waveforms are provided
07. An Exhaustive and Skilled oriented comprehensive instructional manual with complete theory explanation
08. Capacity of 5.5 Kilograms
09. Maximum Rotational Speed of 800 RPM
10. Dark Maroon Top-Loading Fully Automatic Washing Machine

Technical Specification:

- * 10 Fault Switches and 16 Test Points provided on-board.
- * Led indicators provided on the PCB for Fuzzy, Cloth Selection, Wash, Rinse and Spin
- * Block Diagram is provided on glass epoxy PCB for understanding the logic.
- * 5.5Wash Capacity(kg)
- * Washing Machine has Air Dry, Aqua Save, Auto Error Detection, Auto Power OFF, Child Lock, Reversomatic Pulsator, Turbo Soak, Water Fall, Water Level Selection, Memory Backup and Fuzzy Logic Control features
- * Dark Maroon Coloured Metal Body
- * Cold Water inlet
- * PP Inner Tub
- * Various Program Like Normal, Strong, Saree, Wool, Wash, Rinse, Spin
- * Transparent Window
- * PCB Unit enclosed in Powder Coated Metal enclosure
- * Power rating AC 220 - 240 V
- * Power Consumption Average operating mode Less

than 230 W

Experiments:

01. To study of Fully Automatic Washing Machine
02. To study the different sections of Washing Machine
03. To identify different faults of Washing Machine like Buzzer, Pressure sensor, Drain Actuator, Feed Valve Safety Lid sensor, Motor clock wise and Motor anticlockwise
04. To study the Functions of Keypad like Power On Start/ Hold, Process, Program and Water Level

CCTV Trainer

Order Code - 10952



10952 Bench for CCTV Trainer is an ideal training equipment to teach the operation of Close circuit Video. The complete Block of CCTV is printed on single PCB for easy understanding of function of different blocks. Test points allow the analysis and monitoring of the signals in different sections. By using the fault simulation method, it is possible to introduce the most common breakdown and their rectification.

Technical Specifications:

- * Display : 9"Diagonal Size ,Flat panel LED/LCD display
- * Interface
 - Analog Video Input : RGB VGA (HD-15)
 - Analog Video Input : S-Video
 - Composite Video Input : RCA Yellow,
 - Audio Input : RCA- Left (White), Right (Red)
 - Antenna RF Input : RF - SDTV/ PAL
- * On Board Blocks
 - Audio Decoder Block : 4 no's of Audio Channel output
 - Video Decoder Block : 4 no's of Video Channel output
 - Display Block : VGA Connector is provided
 - Ethernet Controller Block : RJ45 Connector is provided
 - USB Block : USB Connector is provided
 - Buzzer Block : Miniature buzzer is provided
 - AudioNideo Amplifier Block : Audio and Video out is provided
 - IR Block : IR LED is provided
 - Keypad Block : Different Keys are provided for Control.
- * Remote Control functions : On screen display of Volume, Brightness, Contrast, Channel
- * Audio Amplifier : 3 W PMPO
- * 35 Test points are provided to analyze signals at various points.
- * 36 no's of DIP Fault Switches are Provided
- * All ICS are mounted on IC Sockets.
- * Bare board Tested Glass Epoxy SMOBC PCB with Block Diagram.
- * Attractive Metal Enclosure

Microwave Oven Trainer

Order Code - 10953



- * General Feature
 - TypeSolo
 - Capacity17 Ltrs
- * Cooking Feature-DefrostYes
- * Body Feature
 - CavityStainless Steel Cavity
 - Control TypeMechanical
- * Power Consumptions
 - Power Consumption1200 Watts
 - Power Level5
- * Physical Features
 - Dimension (W X H X D)452 X 262 X 335
- * Additional Features
 - Child LockYes
 - Alarmyes
- * 9 Test points are provided to analyze signals at various points.
- * All ICS are mounted on IC Sockets.
- * Bare board Tested Glass Epoxy SMOBC PCB with Block Diagram.
- * Attractive Metal Enclosure
- * User Manual for Experiments

Anti Lock Braking Training System

Order Code - 10954

Introduction:

An anti-lock braking system (ABS) is an automobile safety system that allows the wheels on a motor vehicle to maintain attractive contact with the road surface according to driver inputs while braking, preventing the wheels from locking up (ceasing rotation) and avoiding uncontrolled skidding. It is an automated system that uses the principles of threshold braking and cadence braking which were practiced by skilful drivers with previous generation braking systems. It does this at a much faster rate and with better control than a driver could Manage. ABS generally offers improved vehicle control and decreases stopping distances on dry and slippery surfaces; however, on loose gravel or snow-covered surfaces, ABS can significantly increase braking distance, although still improving vehicle control.



Principle Of Anti-lock Brake System:

The anti-lock brake controller is also known as the CAB (Controller Antilock Brake).

Typically ABS includes a central electronic control unit (ECU), four wheel speed sensors, and at least two hydraulic valves within the brake hydraulics. The ECU

constantly monitors the rotational speed of each wheel; if it detects a wheel rotating significantly slower than the others, a condition indicative of impending wheel lock, it actuates the valves to reduce hydraulic pressure to the brake at the affected wheel, thus reducing the braking force on that wheel; the wheel then turns faster. Conversely, if the ECU detects a wheel turning significantly faster than the others, brake hydraulic pressure to the wheel is increased so the braking force is reapplied, slowing down the wheel. This process is repeated continuously and can be detected by the driver via brake pedal pulsation. Some anti-lock systems can apply or release braking pressure 15 times per second. Because of this, the wheels of cars equipped with ABS are practically impossible to lock even during panic braking in extreme conditions. Modern ABS applies individual brake pressure to all four wheels through a control system of hub-mounted sensors and a dedicated micro-controller. ABS is offered or comes standard on most road vehicles produced today and is the foundation for electronic stability control systems, which are rapidly increasing in popularity due to the vast reduction in price of vehicle electronics over the years.

Components of The Trainer:

01. Mains On/Off
02. Digital Control Panel
03. USB Connector Interface
04. Brake Light
05. Electronic Control Unit (ECU)
06. Hydraulic Activator
07. Pressure Gauge
08. Brake Pedal with Master Cylinder

Briefly explain all the components of unit:

01. Main On/Off: To start the trainer
02. Digital Control Panel: To accelerate the wheels by increasing the RPM and pressure consumes by the wheels during press the brake pedal.
03. USB Connector Interface: To connect the data logging software with computer.
04. Brake Light: Light reflects the braking effort being brake pedal applied.
05. Electronic Control Unit (ECU): The ECU constantly monitors the function of components within the system. If any electrically detectable fault occurs, the control unit will illuminate the dashboard warning light to alert the operator.
06. Hydraulic Activator: The supplied main energy source may be electric current, hydraulic fluid pressure.
07. Pressure Gauge: To display actual pressure during applied braking in ABS system.
08. Brake Pedal with Master Cylinder: It is also known as the master brake cylinder, converts the pressure on the brake pedal to hydraulic pressure by feeding brake fluid into the brake circuit and controlling this according to the mechanical force.

For More Details Visit Our New Website www.tescaglobal.com

Logic Training Board OR/NOR Function

Order Code - 38606



Computer Logic Training Board has been designed specifically to study the Principle of OR/NOR Logic Gates and to compare the truth table with experimental results. This training board offers a new method of training students in the basic theory of digital circuits and make them familiar with basic experiments in digital circuits. The board is having integral input arrangements and make the students familiar with the OR/NOR function. The board is absolutely self contained and requires no other apparatus.

Practical experience on this board carries great educative value for Science and Engineering Students.

Object:

To study the principle of OR/NOR logic gates and to compare the truth table with experimental results.

Features:

The board consists of the following built-in parts :

01. + 5V D.C. at 100mA, IC Regulated Power Supply internally connected.
 02. 3-input NOR gate followed by an inverter (NOT gate) to give 3-input OR/NOR gate.
 03. Switches for logic selection.
 04. LEDs for visual indication of status.
 05. Adequate no. of other Electronic Components.
 06. Mains ON/OFF switch, Fuse and Jewel light.
- * The unit is operative on 230V ±10% at 50Hz A.C. Mains.
 - * Adequate no. of patch cords stackable from rear both ends 4mm spring loaded plug length ½ metre.
 - * Good Quality, reliable terminal/sockets are provided at appropriate places on panel for connections / observation of waveforms.
 - * Strongly supported by detailed Operating Instructions, giving details of Object, Theory, Design procedures, Report Suggestions and Book References.

Logic Training Board And/Nand Function

Order Code - 38607



Computer Logic Training Board has been designed specifically to study the Principle of AND/NAND Logic Gates and to compare the truth table with experimental results. This training board offers a new method of training students in the basic theory of digital circuits and make them familiar with basic experiments in digital circuits. The board is having integral input arrangements and make the students familiar with the AND/NAND function. The board is absolutely self contained and requires no other apparatus.

Practical experience on this board carries great educative value for Science and Engineering Students.

Object:

To study the principle of AND/NAND logic gates and to compare the truth table with experimental results.

Features:

The board consists of the following built-in parts :

01. + 5V D.C. at 100mA, IC Regulated Power Supply internally connected.
 02. 3-input NAND gate followed by an inverter (NOT gate) to give 3-input AND/NAND gate.
 03. Switches for logic selection.
 04. LEDs for visual indication of status.
 05. Adequate no. of other Electronic Components.
 06. Mains ON/OFF switch, Fuse and Jewel light.
- * The unit is operative on 230V ±10% at 50Hz A.C. Mains.
 - * Adequate no. of patch cords stackable from rear both ends 4mm spring loaded plug length ½ metre.
 - * Good Quality, reliable terminal/sockets are provided at appropriate places on panel for connections / observation of waveforms.
 - * Strongly supported by detailed Operating Instructions, giving details of Object, Theory, Design procedures, Report Suggestions and Book References.

Logic Training Board Not/buffer Function

Order Code - 38608



Computer Logic Training Board has been designed specifically to study the Principle of NOT/BUFFER Logic Gates and to compare the truth table with experimental results. This training board offers a new method of training students in the basic theory of digital circuits and make them familiar with basic experiments in digital circuits. The board is having integral input arrangements and make the students familiar with the NOT/BUFFER function. The board is absolutely self contained and requires no other apparatus.

Practical experience on this board carries great educative value for Science and Engineering Students.

Object:

To study the principle of NOT/BUFFER logic gates and to compare the truth table with experimental results.

Features:

The board consists of the following built-in parts :

01. + 5V D.C. at 100mA, IC Regulated Power Supply internally connected.
 02. NOT gate followed by another NOT gate to give BUFFER output.
 03. Switches for logic selection.
 04. LEDs for visual indication of status.
 05. Adequate no. of other Electronic Components.
 06. Mains ON/OFF switch, Fuse and Jewel light.
- * The unit is operative on 230V ±10% at 50Hz A.C. Mains.
 - * Adequate no. of patch cords stackable from rear both ends 4mm spring loaded plug length ½ metre.
 - * Good Quality, reliable terminal/sockets are

provided at appropriate places on panel for connections / observation of waveforms.

- * Strongly supported by detailed Operating Instructions, giving details of Object, Theory, Design procedures, Report Suggestions and Book References.

Logic Tutor Board

Order Code - 38609



Computer Logic Training Board has been designed specifically to study simple Logic Functions and Theorems of Boolean Algebra and to compare the truth table with experimental results. This training board offers a new method of training students in the basic theory of digital circuits and make them familiar with basic experiments in digital circuits. The board is absolutely self contained and requires no other apparatus.

Practical experience on this board carries great educative value for Science and Engineering Students.

Object:

To study and verify the following :

01. OR/NOR Function.
02. AND/NAND Function.
03. NOT/BUFFER Function.
04. Simple function of several variables.
05. Distributive Law.
06. Commutative Law.
07. Associative Law.
08. De Morgan's Theorem.

Features:

The board consists of the following built-in parts :

01. + 5V D.C. at 500mA, IC Regulated Power Supply internally connected.
02. Two, 3-input NAND gates followed by an inverter to give 3-input AND/NAND gates.
03. Two, 3-input NOR gates followed by an inverter to give 3-input OR/NOR gates.
04. Two, NOT gates followed by another NOT gate to give BUFFER outputs.
05. Switches for logic selection.
06. LEDs for visual indication of status.
07. Adequate no. of other Electronic Components.
08. Mains ON/OFF switch, Fuse and Jewel light.
- * The unit is operative on 230V $\pm 10\%$ at 50Hz A.C. Mains.
- * Adequate no. of patch cords stackable from rear both ends 4mm spring loaded plug length $\frac{1}{2}$ metre.
- * Good Quality, reliable terminal/sockets are provided at appropriate places on panel for connections / observation of waveforms.
- * Strongly supported by detailed Operating Instructions, giving details of Object, Theory, Design procedures, Report Suggestions and Book References.

Logicom

Order Code - 38610



Computer Logic Training Board has been designed specifically to study the compound logic functions like Full Adder, Half Adder, Even Parity Check, Odd Parity Check, Exclusive OR and different types of Flip-Flops. These all can be synthesized from the most fundamental logic function NAND. The board is absolutely self contained and requires no other apparatus.

Practical experience on this board carries great educative value for Science and Engineering Students.

Object:

01. Compound Logic Function.
 - a. Verification of "AND/NAND" Function.
 - b. Verification of "OR" Function (inclusive OR)
 - c. Study of Function $F = A \cdot (B + C)$
 - d. Study of Coincidence Function $F = A \cdot B +$
 - e. Study of Majority Logic $F = ABC + AC + AB + BC$
02. To study Exclusive OR.
03. To study Half Adder.
04. To study Full Adder.
05. Error detecting codes.
 - a. To study Even Parity Check
 - b. To study Odd Parity Check.
06. Binary storage elements
 - a. Set-Reset Flip-Flop
 - b. Type D Flip-Flop
 - c. J-K Flip-Flop
 - d. Master Slave J-K Flip-Flop
 - e. Type T Flip-Flop.

Features:

The board consists of the following built-in parts :

01. + 5V D.C. at 100mA, IC Regulated Power Supply internally connected.
02. Seven, 2-input AND gates each followed by an inverter to give Seven 2-input NAND gates.
03. Four, 3-input AND gates each followed by an inverter to give four 3-input NAND gates.
04. One gated Flip-Flop.
05. A clock generator with a repetition frequency of 5 Hz.
06. Switches for logic selection.
07. LEDs for visual indication of status.
08. Adequate no. of other Electronic Components.
09. Mains ON/OFF switch and Jewel light.
- * The unit is operative on 230V $\pm 10\%$ at 50Hz A.C. Mains.
- * Adequate no. of patch cords stackable from rear both ends 4mm spring loaded plug length $\frac{1}{2}$ metre.
- * Good Quality, reliable terminal/sockets are provided at appropriate places on panel for connections / observation of waveforms.
- * Strongly supported by detailed Operating Instructions, giving details of Object, Theory, Design procedures, Report Suggestions and Book References.

Logicom- I

Order Code - 38611



Computer Logic Training Board has been designed specifically for the use of students in digital electronic lab. The students can build-up various logic functions and understand their working i.e. Full Adder, Half Adder, Even Parity Check, Odd Parity Check, Exclusive OR and different type of Flip-Flops. These all can be synthesized from the most fundamental logic function NAND. The board is absolutely self contained and requires no other apparatus.

Practical experience on this board carries great educative value for Science and Engineering Students.

Object:

To study and verify the following:

01. AND/NAND function.
02. OR function.
03. Function $F=A.(B+C)$
04. Exclusive OR function.
05. Coincidence circuit.
06. Full Adder.
07. Majority logic.
08. Error Detecting Codes.
 - * Even parity check.
 - * Odd parity check.
09. Binary storage elements.
10. Set-Reset Flip-Flop.
11. (a) Type 'D' Flip-Flop.
(b) Edge Triggered Type 'D' Flip-Flop.
12. J-K Flip-Flop
13. Master Slave J-K Flip-Flop.
14. Type 'T' Flip-Flop.

Features:

The board consists of the following built-in parts :

01. + 5V D.C. at 200mA, IC Regulated Power Supply internally connected.
02. Nine, 3-input AND gates whose outputs is connected to an inverter (NOT gate) to give 3-input NAND gates.
03. A clock generator with a repetition frequency of 5 Hz.
04. Two lamps (LEDs) driver circuits each of which individually drives a lamp (LED).
05. Switches for logic selection.
06. Lamps (LEDs) for visual indication of status.
07. Adequate no. of other Electronic Components.
08. Mains ON/OFF switch, Fuse and Jewel light.
 - * The unit is operative on 230V $\pm 10\%$ at 50Hz A.C. Mains.
 - * Adequate no. of patch cords stackable from rear both ends 4mm spring loaded plug length $\frac{1}{2}$ metre.
 - * Good Quality, reliable terminal/sockets are provided at appropriate places on panel for connections / observation of waveforms.
 - * Strongly supported by detailed Operating Instructions, giving details of Object, Theory, Design procedures, Report Suggestions and Book References.

Logicom- II

Order Code - 38612



Computer Logic Training Board has been designed

specifically for the use of students in digital electronic lab. The students can build-up various logic functions and understand their working i.e. Full Adder, Half Adder, Even Parity Check, Odd Parity Check, Exclusive OR and different type of Logic Circuits. The board is absolutely self contained and requires no other apparatus.

Practical experience on this board carries great educative value for Science and Engineering Students.

Object:

To study and verify the following:

01. OR/NOR function.
02. AND/NAND function.
03. Exclusive OR function.
04. Function $F=A.(B+C)$.
05. Coincidence circuit.
06. Majority logic.
07. Minority logic.
08. Error Detecting Codes and Parity Check.
09. Half Adder.
10. Full Adder.

Features:

The board consists of the following built-in parts :

01. + 5V D.C. at 500mA, IC Regulated Power Supply internally connected.
02. Twelve, 2-input OR gates each followed by an inverter (NOT gate) to give 2-input NOR gates.
03. A clock generator with a repetition frequency of 5 Hz.
04. Two LED driver circuits each of which individually drives a LED.
05. Switches for logic selection.
06. LEDs for visual indication of status.
07. Adequate no. of other Electronic Components.
08. Mains ON/OFF switch, Fuse and Jewel light.
 - * The unit is operative on 230V $\pm 10\%$ at 50Hz A.C. Mains.
 - * Adequate no. of patch cords stackable from rear both ends 4mm spring loaded plug length $\frac{1}{2}$ metre.
 - * Good Quality, reliable terminal/sockets are provided at appropriate places on panel for connections / observation of waveforms.
 - * Strongly supported by detailed Operating Instructions, giving details of Object, Theory, Design procedures, Report Suggestions and Book References.

Logicom- III

Order Code - 38613

Computer Logic Training Board has been designed specifically for the use of students in digital electronic lab. The students can build-up various logic functions and understand their working i.e. Full Adder, Half Adder, Even Parity Check, Odd Parity Check, Exclusive OR and different type of Logic Circuits. The board is absolutely self contained and requires no other apparatus.

Practical experience on this board carries great educative value for Science and Engineering Students.

Object:

To study and verify the following:

01. OR/NOR function.
02. AND/NAND function.
03. Exclusive OR function.
04. Function $F= A.(B+C)$.
05. Coincidence circuit.

06. Majority logic.
07. Minority logic.
08. Error Detecting Codes and Parity Check.
09. Half Adder.
10. Full Adder.

Features:

The board consists of the following built-in parts :

01. + 5V D.C. at 500mA, IC Regulated Power Supply internally connected.
02. Six Inverters (NOT gates).
03. Four, 2-input AND gates.
04. Four, 2-input OR gates.
05. A clock generator with a repetition frequency of 5 Hz.
06. Two LED driver circuits each of which individually drives a LED.
07. Switches for logic selection.
08. LEDs for visual indication of status.
09. Adequate no. of other Electronic Components.
10. Mains ON/OFF switch, Fuse and Jewel light.
- * The unit is operative on 230V ±10% at 50Hz A.C. Mains.
- * Adequate no. of patch cords stackable from rear both ends 4mm spring loaded plug length ½ metre.
- * Good Quality, reliable terminal/sockets are provided at appropriate places on panel for connections / observation of waveforms.
- * Strongly supported by detailed Operating Instructions, giving details of Object, Theory, Design procedures, Report Suggestions and Book References.
- * Weight : 3 Kg. (Approx.)
- * Dimension : W 340 x H 110 x D 210

Logicom- IV

Order Code - 38614



Computer Logic Training Board has been designed specifically to study different type of counters i.e. Up-Counter, Down Counter and Decimal Counter. The board is absolutely self contained and requires no other apparatus. Practical experience on this board carries great educative value for Science and Engineering Students.

Object:

To study the following different types of counters:

01. Up-Counter.
02. Down Counter.
03. Decimal Counter.

Features:

The board consists of the following built-in parts :

01. + 5V D.C. at 1Amp, IC Regulated Power Supply internally connected.
02. Nine J-K Flip-Flops.
03. A clock generator with a repetition frequency of 500 Hz.
04. Two LED driver circuits each of which individually drives a LED and is connected to the binary output

of the Flip-Flop.

05. Two pulsar switches.
06. LEDs for visual indication of status.
07. Adequate no. of other Electronic Components.
08. Mains ON/OFF switch, Fuse and Jewel light.
- * The unit is operative on 230V ±10% at 50Hz A.C. Mains.
- * Adequate no. of patch cords stackable from rear both ends 4mm spring loaded plug length ½ metre.
- * Good Quality, reliable terminal/sockets are provided at appropriate places on panel for connections / observation of waveforms.
- * Strongly supported by detailed Operating Instructions, giving details of Object, Theory, Design procedures, Report Suggestions and Book References.

Logic Laboratory

Order Code - 38615



Computer Logic Laboratory is a combined board for all the experiments covered under Order Code 38611, 38612, 38613, 38614 Logicom. This laboratory has been designed specifically for the use of students in digital electronic lab. The students can build-up various logic functions and understand their working of different types logic circuits. The board is absolutely self contained and requires no other apparatus. Practical experience on this board carries great educative value for Science and Engineering Students.

Object:

To study and verify the following:

01. AND/NAND function.
02. OR function.
03. Function $F = A \cdot (B + C)$
04. Exclusive OR function.
05. Coincidence circuit.
06. Full Adder.
07. Half Adder.
08. Majority logic.
09. Minority logic.
10. Even parity check.
11. Odd parity check.
12. Binary storage elements.
13. Set-Reset Flip-Flop.
14. Type D Flip-Flop.
15. J-K Flip-Flop
16. Master Slave J-K Flip-Flop.
17. Type T Flip-Flop.
18. OR/NOR function.
19. UP-Counter.
20. DOWN Counter.
21. Decimal Counter.
22. Error detecting codes and Parity Check.

Features:

The logic laboratory consists of the following :

01. Logicom-I Order Code 38611 consists of:
 - + 5V D.C. at 200mA, IC Regulated Power Supply internally connected.
 - Nine, 3-input AND gates each followed by an inverter to give 3-input NAND gates.

- A clock generator with a repetition frequency of 500 Hz.
 - Two LED driver circuits each of which individually drives a LED.
02. Logicom-II Order Code 38612 consists of:
- + 5V D.C. at 500mA, IC Regulated Power Supply internally connected.
 - Twelve, 2-input OR gates each followed by an inverter to give 2-input NOR gates.
 - A clock generator with a repetition frequency of 500 Hz.
 - Two LED driver circuits each of which individually drives a LED.
03. Logicom-III Order Code 38613 consists of:
- +5V D.C. at 500mA, IC Regulated Power Supply internally connected.
 - Six Inverters.
 - Four, 2-input AND gates.
 - Four, 2-input OR gates.
 - A clock generator with a repetition frequency of 500 Hz.
 - Two LED driver circuits each of which individually drives a LED.
04. Logicom-IV Order Code 38614 consists of:
- + 5V D.C. at 1Amp, IC Regulated Power Supply internally connected.
 - Nine J-K Flip-Flop.
 - A clock generator with a repetition frequency of 500 Hz.
 - Two LED driver circuits each of which individually drives a LED and is connected to the binary output of the Flip-Flop.
 - Two pulser switches.
05. Switches for logic selection.
06. LEDs for visual indication of status.
07. Adequate no. of other Electronic Components.
08. Mains ON/OFF switch, Fuse and Jewel light.
- * The unit is operative on 230V \pm 10% at 50Hz A.C. Mains.
 - * Adequate no. of patch cords stackable from rear both ends 4mm spring loaded plug length 1/2 metre.
 - * Good Quality, reliable terminal/sockets are provided at appropriate places on panel for connections / observation of waveforms.
 - * Strongly supported by detailed Operating Instructions, giving details of Object, Theory, Design procedures, Report Suggestions and Book References.

Logic Training Board on Counters & Shift Registers

Order Code - 38616



Computer Logic Training Board has been designed specifically for the study of Counters & Shift Registers to make the student familiar with the design and practical aspects of all types of counters, shift registers and their applications in frequency measurements and computers etc. This board with gates and Flip-Flops can be used to construct any type of counter, shift register etc. and the output of each circuit can also be observed in decimal code with the help of decoder and Seven Segment Display. More than 25 experiments can be

conducted on this training board. These experiments cover several aspects of computer, input and output devices, memories, arithmetic and control units. Once the student understands these basic circuits, he can combine them in infinite varieties of complex circuits. Practical experience on this board carries great educative value for Science and Engineering Students.

Object:

To design, fabricate and test the following:

(A) Counters

(a) Ripple Counters:

01. 4-Stage binary ripple up-counter.
02. 4-Stage binary ripple down-counter.
03. 4-Stage binary ripple up-down counter.
04. Variable modules ripple counter by direct clearing.
05. 4-Stage decade ripple up-counter by direct clearing.
06. 4-Stage decade ripple down counter by direct clearing.

(b) Synchronous Counters:

07. 4-Stage binary synchronous up-counter with parallel carry.
08. 4-Stage binary synchronous down-counter with parallel carry.
09. 4-Stage binary synchronous up-counter with series carry.
10. 4-Stage binary synchronous down-counter with series carry.
11. 4-Stage binary synchronous up-down counter with parallel carry.
12. 4-Stage synchronous up-down counter with series carry.
13. 4-Stage synchronous decade counter with parallel carry.

(c) Series Parallel Counters:

14. 3-Stage mod-5 series parallel counter.
15. 4-Stage mod-10 series parallel counter.

(d) Ring Counter:

16. 4-Stage ring counter.

(e) Johnson Counters:

17. 4-Stage Johnson or shift counter.
18. Decade counter using 5-stage shift counter.

(f) Miscellaneous Counters:

19. Higher Modules counter by combining two lower modules counter.
20. 2421 BCD counter.

(B) Shift Registers

To study the operation of:

21. Serial to parallel converter.
22. Series-in-series output register.
23. Parallel to serial converter.
24. Parallel-in-parallel out register.
25. Right shift and left-shift register.

(C) Application of Counters

26. To study the basic principle of frequency measurement.
27. To study the operation of frequency division by counter.
28. To study the principle of Random Access Memory by constructing its basic cell.

Features:

The board consists of the following built-in parts:

01. + 5V D.C. at 1Amp, IC Regulated Power Supply Internally connected.
02. Five, J-K master slave flip-flops with preset and

clear arrangement.

03. Six, 2-input NAND gates.
04. Four, 4-input NAND gates.
05. Three, 4-input AND-OR gates.
06. Two inverters (NOT gates).
07. A 4-bit binary counter to demonstrate the basic principles of frequency measurement.

Analog to Digital Converter (A to D)

Order Code - 38617



Computer Logic Training Board has been designed specifically for the study of Analog to Digital Converter. The board is absolutely self contained and requires no other apparatus.

Practical experience on this board carries great educative value for Science and Engineering Students.

Object:

01. To study the basic principle on conversion of analog signal to digital signal.
02. To study the working of Digital Voltmeter.

Features:

The board consists of the following built-in parts :

01. + 5V D.C. at 250mA, IC Regulated Power Supply internally connected.
 02. - 5V D.C. at 50mA, IC Regulated Power Supply internally connected.
 03. + 10V D.C. at 50mA, IC Regulated Power Supply internally connected.
 04. 0-15V D.C. at 50mA, continuously variable Power Supply.
 05. D.C. Voltmeter, 65mm rectangular dial to read 0-15V.
 06. Voltage comparator.
 07. Quad 2-input NAND gate.
 08. Quad 2-input NOR gate.
 09. Quad 2-input AND gate.
 10. Dual 4-input AND gate.
 11. Quad 2-input EX-OR gate.
 12. Three, Hex Buffer/Driver.
 13. BCD-to-7 Segment Decoder/Driver.
 14. Dual J-K Flip-Flop.
 15. 4-Bit Binary Ripple Counter.
 16. Timer.
 17. Continuous monitoring of analog signals on a voltmeter and of digital signals on 7 segment display.
 18. Seven LEDs to display the state of various important points.
 19. Two seven segment displays for visual indication of output status.
 20. Provision for manual pulses as well as for internal clock.
 21. Adequate no. of other Electronic Components.
 22. Mains ON/OFF switch, Fuse and Jewel light.
- * Adequate no. of patch cords stackable from rear both ends 4mm spring loaded plug length ½ metre.
 - * Good Quality, reliable terminal/sockets are provided at appropriate places on panel for connections / observation of waveforms.
 - * Strongly supported by detailed Operating

Instructions, giving details of Object, Theory, Design procedures, Report Suggestions and Book References.

Technical Specifications:

Analog signal variation	: 0 to +15V
Digital word length	: 4 bits
Decoder display	: 0 to 15
(using 7-segments)	
Leds indications	: LED will glow for '1' state and will be OFF for '0' state.
Supply required	: 230V ±10% at 50Hz A.C. Mains.

Digital To Analog Converter (D to A)

Order Code - 38618



Computer Logic Training Board has been designed specifically for the study of Digital to Analog Conversion and to make the students familiar with the basic principle & techniques of "Digital to Analog Conversion". Input state switches with storage register are provided to feed the derived digital input and analog output can be read directly on a voltmeter in terms of voltage. The board is absolutely self contained and requires no other apparatus.

Practical experience on this board carries great educative value for Science and Engineering Students.

Object:

To study the basic principle on Digital to Analog Conversion.

Features:

The board consists of the following built-in parts :

01. + 5V D.C. at 250mA, IC Regulated Power Supply internally connected.
 02. +10V D.C. at 50mA, Power Supply internally connected.
 03. -10V D.C. at 50mA, Power Supply internally connected.
 04. D.C. Voltmeter, 65mm rectangular dial to read 0-5V.
 05. Four, D-type Flip-Flops.
 06. Four Level Amplifiers.
 07. Continuous monitoring of analog signals on a voltmeter.
 08. Four switches for giving binary logic input states.
 09. Four LEDs for visual indication of binary logic input status.
 10. Adequate no. of other Electronic Components.
 11. Mains ON/OFF switch, Fuse and Jewel light.
- * Adequate no. of patch cords stackable from rear both ends 4mm spring loaded plug length ½ metre.
 - * Good Quality, reliable terminal/sockets are provided at appropriate places on panel for connections / observation of waveforms.
 - * Strongly supported by detailed Operating Instructions, giving details of Object, Theory, Design procedures, Report Suggestions and Book References.

Technical Specifications:

- Digital input word length : 4 bits.
- Input storage register : 4 d type flip-flops.
- Analog signal variation : 0 to +5v.
- Analog display : a voltmeter 0-5v with linear calibration.
- Supply required : 230v ±10% at 50hz a.c. Mains.
- D/a mode : using binary weighted ladder network.



Computer Logic Training Board has been designed specifically for the study of 2-Input Digital Multiplexer. The technique of multiplexing is frequently used where a number of digital signals are to be processed simultaneously or sent together over a significant distance to minimize the number of circuits or communication channels. The board is absolutely self contained and requires no other apparatus. Practical experience on this board carries great educative value for Science and Engineering Students.

Binary to Decimal Encoder

Order Code - 38619



Computer Logic Training Board has been designed specifically for the study of Binary to Decimal Encoder. There are arrangements for changing the binary input with the help of a selector switch as well as to feed the unknown 4-bit binary code to read decimal value on seven segment display. The board is absolutely self contained and requires no other apparatus. Practical experience on this board carries great educative value for Science and Engineering Students.

Object:

To study the Binary To Decimal Encoder.

Features:

- The board consists of the following built-in parts :
- 01. + 5V D.C. at 50mA, IC Regulated Power Supply internally connected.
- 02. BCD-to-7-Segment Decoder/Driver.
- 03. A selector switch to set digits from 0 to 9 with corresponding binary code indicator.
- 04. A DPDT switch for lamp test of seven segment display.
- 05. Switch for logic selection.
- 06. LEDs for visual indication of binary code A,B,C,D.
- 07. Adequate no. of other Electronic Components.
- 08. Mains ON/OFF switch, Fuse and Jewel light.
- * The unit is operative on 230V ±10% at 50Hz A.C. Mains.
- * Adequate no. of patch cords stackable from rear both ends 4mm spring loaded plug length ½ metre.
- * Good Quality, reliable terminal/sockets are provided at appropriate places on panel for connections / observation of waveforms.
- * Strongly supported by detailed Operating Instructions, giving details of Object, Theory, Design procedures, Report Suggestions and Book References.

Technical Specifications:

- Input word length : 4- Bit
- Seven segment display : 0 TO 9
- Led indication : LED will glow for '1' state and will be OFF for '0' state.

2 Input Digital Multiplexer

Order Code - 38620

Object:

To study the operation of a 2-Input Digital Multiplexer.

Features:

- The board consists of the following built-in parts :
- 01. + 5V D.C. at 50mA, IC Regulated Power Supply internally connected.
- 02. One Digital Multiplexer IC.
- 03. Three switches to set the data and control bits.
- 04. LED for visual indication of selected channel.
- 05. Adequate no. of other Electronic Components.
- 06. Mains ON/OFF switch, Fuse and Jewel light.
- * The unit is operative on 230V ±10% at 50Hz A.C. Mains.
- * Good Quality, reliable terminal/sockets are provided at appropriate places on panel for connections / observation of waveforms.
- * Strongly supported by detailed Operating Instructions, giving details of Object, Theory, Design procedures, Report Suggestions and Book References.

Binary to Decimal Encoder

Order Code - 38621



Computer Logic Training Board has been designed specifically for the study of Digital IC Circuits. The board is designed to train students of Engineering Colleges & Polytechnic Laboratories, in Digital IC circuits. Digital IC Trainer is a completely self contained, most versatile, sophisticated and economical. The board is absolutely self contained and requires no other apparatus. Practical experience on this board carries great educative value for Science and Engineering Students.

Features:

- 01. Fully self sufficient with IC Regulated 5V at 1Amp. Power Supply, input logic switches, clock generator, mono pulser.
- 02. LED logic indicators, 3 digit Seven Segment Displays and provision to take-out output for monitoring.
- 03. Sockets for ICs, reliable connections using excellent quality sockets.
- 04. Wiring of all types of experiments become simple and less time consuming.

- 05. Adequate no. of other Electronic Components.
- 06. The unit is operative on 230V \pm 10% at 50Hz A.C. Mains.
- 07. Adequate no. of patch cords stackable from rear both ends 2mm spring loaded plug length 1/2 metre.
- 08. Strongly supported by detailed Operating Instructions, giving details of Object, Theory, Design procedures, Report Suggestions and Book References. Two copies each with the trainer board.
- * Weight : 8 Kg. (Approx.)
- * Dimension : W 412 x H 150 x D 310

Technical Specifications:

- 01. + 5V D.C. at 1Amp, IC Regulated Power Supply.
- 02. Eight, two position toggle switches prewired to give binary logic input states.
- 03. Eight, LED logic indicators with transistor drivers.
- 04. 3 digit Seven Segment Displays with decoder driver.
- 05. Clock :- 1 Hz, 1 kHz and 1 MHz.
- 06. Single pulse from mono pulser.
- 07. IC Bases :-
 - 16 Pin DIP/ZIF : 3 Nos
 - 28 Pin DIP/ZIF : 1 Nos

Boolean Algebra Trainer

Order Code - 38622



Computer Logic Training Board has been designed specifically on Boolean Algebra to study the Boolean Algebraic theorems and verification of the same. By using the clearly marked built-in logic gates, students can implement logic circuits for verification of Boolean Algebraic theorems. The board is absolutely self contained and requires no other apparatus. Practical experience on this board carries great educative value for Science and Engineering Students.

Object:

- To study the following Boolean Algebraic theorems and verification of the same.
- 01. Single variable theorems.
 - 02. More than one variable theorems.
 - 03. Demorgan's theorems.

Features:

- The board consists of the following built-in parts :
- 01. + 5V D.C. at 100mA, IC Regulated Power Supply.
 - 02. Four NOT gates.
 - 03. Three, 3-input AND gates.
 - 04. Three, 3-input OR gates.
 - 05. Three switches for giving binary logic input states.
 - 06. Two LEDs, driven by LED driver circuit for visual indication of output.
 - 07. Adequate no. of other Electronic Components.
 - 08. Mains ON/OFF switch, Fuse and Jewel light.
 - * The unit is operative on 230V \pm 10% at 50Hz A.C. Mains.
 - * Adequate no. of patch cords stackable from rear both ends 4mm spring loaded plug length 1/2 metre.
 - * Good Quality, reliable terminal/sockets are provided at appropriate places on panel for

- connections / observation of waveforms.
- * Strongly supported by detailed Operating Instructions, giving details of Object, Theory, Design procedures, Report Suggestions and Book References.

Study of OR, AND, NAND Gates

Order Code - 38623



Computer Logic Training Board has been designed specifically to study OR, AND, NOT, EX-OR & NAND logic gates and to verify the truth table of various logic functions by using universal NAND gates. The board is absolutely self contained and requires no other apparatus.

Practical experience on this board carries great educative value for Science and Engineering Students.

Object:

- 01. To Study the OR, AND & NAND logic gates and to verify the truth tables.
- 02. To make various logic functions (OR, NOR, NOT, AND & EX-OR gates) by using NAND gates and verify their truth tables.

Features:

- The board consists of the following built-in parts :
- 01. + 5V D.C. at 100mA, IC Regulated Power Supply internally connected.
 - 02. Four, 2-input NAND gates.
 - 03. 2-input OR gate.
 - 04. 2-input AND gate.
 - 05. Two switches for giving binary logic input states.
 - 06. Two LEDs, driven by LED driver circuit for visual indication of output.
 - 07. Adequate no. of other Electronic Components.
 - 08. Mains ON/OFF switch, Fuse and Jewel light.
 - * The unit is operative on 230V \pm 10% at 50Hz A.C. Mains.
 - * Adequate no. of patch cords stackable from rear both ends 4mm spring loaded plug length 1/2 metre.
 - * Good Quality, reliable terminal/sockets are provided at appropriate places on panel for connections / observation of waveforms.
 - * Strongly supported by detailed Operating Instructions, giving details of Object, Theory, Design procedures, Report Suggestions and Book References.

Study of OR, AND, NOT Logic Gates

Order Code - 38624



Computer Logic Training Board has been designed specifically to study OR, AND, NOT logic gates using discrete components and compare it with TTL integrated circuits (IC's). The board is absolutely self contained and requires no other apparatus. Practical experience on this board carries great

educative value for Science and Engineering Students.

Object:

To study the OR, AND, NOT logic gates using discrete components and compare it with TTL ICs.

Features:

The board consists of the following built-in parts :

- 01. + 5V D.C. at 100mA, IC Regulated Power Supply.
- 02. NOT gate.
- 03. 3-input AND gate.
- 04. 3-input OR gate.
- 05. Three switches for giving binary logic input states.
- 06. Two LEDs, driven by LED driver circuit for visual indication of output.
- 07. Adequate no. of other Electronic Components.
- 08. Mains ON/OFF switch and Fuse.
- * The unit is operative on 230V ±10% at 50Hz A.C. Mains.
- * Adequate no. of patch cords stackable from rear both ends 4mm spring loaded plug length ½ meter.
- * Good Quality, reliable terminal/sockets are provided at appropriate places on panel for connections / observation of waveforms.
- * Strongly supported by detailed Operating Instructions, giving details of Object, Theory, Design procedures, Report Suggestions and Book References.

To Study The Characteristics and Operation of a Programmable Counter

Order Code - 38625



Computer Logic Training Board has been designed specifically for the study & Operation of Programmable Counter to give students an idea about Programmable Counters and different modes of the same. The output of counter can be observed in decimal code with the help of seven segment displays. The board is absolutely self contained and requires no other apparatus. Practical experience on this board carries great educative value for Science and Engineering Students.

Object:

- 01. To study the Programmable Counter in up-mode and carry pulse.,
- 02. To study the Programmable Counter in down-mode and borrow pulse.
- 03. To study the presettable mode of the Programmable Counter.

Features:

The board consists of the following built-in parts :

- 01. +5V D.C. at 100mA, IC Regulated Power Supply internally connected.
- 02. Programmable Counter IC 74193.
- 03. Decoder Circuit.
- 04. Two seven segment displays with decoder circuit to display the output in decimal.
- 05. One Pulser switch for clock.
- 06. Two press switches for clear & load.
- 07. Switches for logic selection.

08. Adequate no. of other Electronic Components.

09. Mains ON/OFF switch, Fuse and Jewel light.

- * The unit is operative on 230V ±10% at 50Hz A.C. Mains.
- * Adequate no. of patch cords stackable from rear both ends 4mm spring loaded plug length ½ metre.
- * Good Quality, reliable terminal/sockets are provided at appropriate places on panel for connections / observation of waveforms.
- * Strongly supported by detailed Operating Instructions, giving details of Object, Theory, Design procedures, Report Suggestions and Book References.

Study of Universal Logic Gates & Applications

Order Code - 38626



Computer Logic Training Board has been designed specifically to study Universal Logic Gates and Applications. This Training Board is designed to verify the truth table of various logic functions, to prove De-morgan's theorem, Half adder and Full adder by using universal logic gates. The board is absolutely self contained and requires no other apparatus.

Practical experience on this board carries great educative value for Science and Engineering Students.

Object:

- 01. To study the operation and characteristics of a TTL NAND / NOR gate.
- 02. To prove the De-morgan's Theorem by using NOR & NAND gates.
- 03. To perform various logic functions using NOR and NAND gates i.e. OR, AND, NOT, NOR, NAND, Exclusive OR (EX-OR), Half adder and Full adder.

Features:

The board consists of the following built-in parts :

- 01. +5V D.C. at 100mA, IC Regulated Power Supply internally connected.
- 02. Ten, 2-input NAND gates.
- 03. Sixteen, 2-input NOR gates.
- 04. Switches for logic selection.
- 05. LEDs for visual indication of status.
- 06. Adequate no. of other Electronic Components.
- 07. Mains ON/OFF switch, Fuse and Jewel light.
- * The unit is operative on 230V ±10% at 50Hz A.C. Mains.
- * Adequate no. of patch cords stackable from rear both ends 4mm spring loaded plug length ½ metre.
- * Good Quality, reliable terminal/sockets are provided at appropriate places on panel for connections / observation of waveforms.
- * Strongly supported by detailed Operating Instructions, giving details of Object, Theory, Design procedures, Report Suggestions and Book References.

Study of Various Modulo Counters

Order Code - 38627



Computer Logic Training Board has been designed specifically to study Various Modulo Counters. This Training Board gives a better understanding of the design, working & practical aspects of counters. Gates and flip-flops can be used to construct any type of counter. Output of each counter circuit can also be observed in decimal code with the help of the seven segment displays. The board is absolutely self contained and requires no other apparatus. Practical experience on this board carries great educative value for Science and Engineering Students.

Object:

To construct & study the following Modulo Counters :

01. Fixed Modulo 4 bit Binary Ripple Counter in :
 - 1.1 Count-Up mode.
 - 1.2 Count-Down mode.
 - 1.3 Count-Up/Down mode
02. Four stage Ring Counter.
03. Variable Modulo Counters.

Features:

The board consists of the following built-in parts :

01. +5V D.C. at 100mA, IC Regulated Power Supply.
02. Four master slave J-K flip-flops with preset and clear terminals.
03. Three, 2-input AND-OR gate combinations.
04. One inverter (NOT gate).
05. 4-input NAND gate.
06. Completely programmable panel to make any type of counter.
07. Switches for logic selection.
08. LEDs for visual indication of output of each flip-flop.
09. Seven segment display with decoder circuit to display the output in decimal code.
10. One pulser switch for clock & one press switch for clear.
11. Adequate no. of other Electronic Components.
12. Mains ON/OFF switch, Fuse and Jewel light.
- * The unit is operative on 230V ±10% at 50Hz A.C. Mains.
- * Adequate no. of patch cords stackable from rear both ends 4mm spring loaded plug length ½ metre.
- * Good Quality, reliable terminal/sockets are provided at appropriate places on panel for connections / observation of waveforms.
- * Strongly supported by detailed Operating Instructions, giving details of Object, Theory, Design procedures, Report Suggestions and Book References.

Study of arithmetic Logic Unit Chip (74181)

Order Code - 38628



Computer Logic Training Board has been designed specifically for the study of Arithmetic & Logic function by using 74181 chip. The board is absolutely self contained and requires no other apparatus. Practical experience on this board carries great educative value for Science and Engineering Students.

Object:

To study the Arithmetic Logic Unit (A.L.U.) chip 74181 for performing the following operations.

01. Logical operation.
02. Arithmetic operation.
03. Comparison of Two Binary numbers.

Features:

The board consists of the following built-in parts :

01. +5V D.C. at 100mA, IC Regulated Power Supply of internally connected.
02. One A.L.U. IC 74181.
03. One Logic state indicator to check the logic state of various pins of IC.
04. Switches for logic selection.
05. LEDs for visual indication of output data.
06. Adequate no. of other Electronic Components.
07. Mains ON/OFF switch, Fuse and Jewel light.
- * The unit is operative on 230V ±10% at 50Hz A.C. Mains.
- * Adequate no. of patch cords stackable from rear both ends 4mm spring loaded plug length ½ metre.
- * Good Quality, reliable terminal/sockets are provided at appropriate places on panel for connections / observation of waveforms.
- * Strongly supported by detailed Operating Instructions, giving details of Object, Theory, Design procedures, Report Suggestions and Book References.

Study Of Various Decoders Using Ics

Order Code - 38629



Computer Logic Training Board has been designed specifically for the study of various Decoders using ICs to give students an idea about decoders. The outputs of BCD to decimal decoder are observed with the help of logic level indicators, LEDs & outputs of BCD to seven segment decoder are observed by using seven segment display. The board is absolutely self contained and requires no other apparatus. Practical experience on this board carries great educative value for Science and Engineering Students.

Object:

01. To study the operations of a BCD to decimal decoder.
02. To demonstrate the operations of BCD to seven segment decoder/Driver.

Features:

The board consists of the following built-in parts :

01. +5V D.C. at 100mA, IC Regulated Power Supply of internally connected.
02. BCD to Decimal Decoder.
03. BCD to Seven segment decoder/driver.
04. Four switches to provide BCD data inputs.
05. Two switches to control LT (Lamp Test) and RBI (Ripple Blanking Input).
06. Ten Logic level indicator LEDs & one seven segment display with decoder circuit to display the outputs.
07. Adequate no. of other Electronic Components.
08. Mains ON/OFF switch, Fuse and Jewel light.
- * The unit is operative on 230V ±10% at 50Hz A.C.

Mains.

- * Adequate no. of patch cords stackable from rear both ends 4mm spring loaded plug length ½ metre.
- * Good Quality, reliable terminal/sockets are provided at appropriate places on panel for connections / observation of waveforms.
- * Strongly supported by detailed Operating Instructions, giving details of Object, Theory, Design procedures, Report Suggestions and Book References.

Study of Various Types of Flip - Flops

Order Code - 38630



Computer Logic Training Board on Flip-Flops has been specifically designed to give students an idea about Flip- Flops and to study different types of Flip-Flops. The output of the Flip-Flops can be observed with the help of logic level indicators (LEDs), which are provided on the panel. The board is absolutely self contained and requires no other apparatus. Practical experience on this board carries great educative value for Science and Engineering Students.

Object:

To construct the following Flip-Flops and study their characteristics :

01. R.S. Flip-Flop without clock.
02. R.S. Flip-Flop with clock.
03. D Flip-Flop.
04. J-K Flip-Flop.
05. T Flip-Flop.
06. Master Slave J-K Flip-Flop.

Features

The board consists of the following built-in parts :

01. +5V D.C. at 100mA, IC regulated power supply.
02. Four, 2-input NAND gates.
03. Four, 3-input NAND gates.
04. One inverter (NOT gate).
05. Four LEDs with driver circuit to observe the output of flip-flops.
06. A pulser to provide the pulses manually for triggering.
07. Adequate no. of other Electronic Components.
08. Mains ON/OFF switch, Fuse and Jewel light.
- * The unit is operative on 230V ±10% at 50Hz A.C. Mains.
- * Adequate no. of patch cords stackable from rear both ends 4mm spring loaded plug length ½ metre.
- * Good Quality, reliable terminal/sockets are provided at appropriate places on panel for connections / observation of waveforms.
- * Strongly supported by detailed Operating Instructions, giving details of Object, Theory, Design procedures, Report Suggestions and Book References.

Study of Decade Counters Using ICs 7490 & 7493

Order Code - 38631



Computer Logic Training Board has been designed specifically for the study of Decade Counters using ICs 7490 & 7493. This Training Board gives students an idea about Decade Counters. The output of counter can be observed in decimal code with the help of decoder and seven segment display which are provided on the panel. The board is absolutely self contained and requires no other apparatus.

Practical experience on this board carries great educative value for Science and Engineering Students.

Object:

01. Study of Decade Counter using IC 7490 in 2 X 5 mode.
02. Study of Decade Counter using IC 7490 in 5 X 2 mode.
03. Study of Decade Counter using IC 7493 in direct clearing mode.

Features:

The board consists of the following built-in parts :

01. +5V D.C. at 100mA, IC Regulated Power Supply.
02. Decade Counter IC 7490.
03. 4 Bit Binary Counter IC 7493, used as decade counter.
04. Two digit Seven segment display with decoder circuit to display the output in decimal.
05. One Pulser to provide clock.
06. 4- input AND gate.
07. Two, 1-input NOT gates.
08. Switches for logic selection.
09. Adequate no. of other Electronic Components.
10. Mains ON/OFF switch, Fuse and Jewel light.
- * The unit is operative on 230V ±10% at 50Hz A.C. Mains.
- * Adequate nos. of patch cords stackable from rear both ends 4mm spring loaded plug, length ½ metre
- * Good Quality, reliable terminal/sockets are provided at appropriate places on panel for connections / observation of waveforms.
- * Strongly supported by detailed Operating Instructions, giving details of Object, Theory, Design procedures, Report Suggestions and Book References.

Study of Left and Right Shift Registers & Ring Counter

Order Code - 38632



Computer Logic Training Board has been designed specifically for the study of Left & Right Shift Registers & Ring Counter. This Training Board makes the student familiar about the working, practical aspect and design of the same by using inverter & J-K flip-flops. The board is absolutely self contained and requires no other apparatus.

Practical experience on this board carries great educative value for Science and Engineering Students.

Object:

01. To study right shift register.
02. To study left shift register.
03. To study ring counter.

Features:

The board consists of the following built-in parts :

01. +5V D.C. at 100mA, IC Regulated Power Supply.
 02. Two dual J-K Flip-Flop with preset & clear arrangement.
 03. One inverter (NOT gate).
 04. One press switch for clear & one pulser switch for the clock.
 05. Four switches to preset the Flip-Flops.
 06. LEDs for visual indication of output of each flip-flop.
 07. Adequate no. of other Electronic Components.
 08. Mains ON/OFF switch, Fuse and Jewel light.
- * The unit is operative on 230V \pm 10% at 50Hz A.C. Mains.
 - * Adequate nos. of patch cords stackable from rear both ends 4mm spring loaded plug, length ½ metre
 - * Good Quality, reliable terminal/sockets are provided at appropriate places on panel for connections / observation of waveforms.
 - * Strongly supported by detailed Operating Instructions, giving details of Object, Theory, Design procedures, Report Suggestions and Book References.

Decimal to BCD Converter

Order Code - 38633



Computer Logic Training Board has been designed specifically for the study of Decimal to BCD (Binary Coded Decimal) converter. This Training Board makes the student familiar with the design & practical aspects of Decimal to BCD conversion. The board is absolutely self contained and requires no other apparatus. Practical experience on this board carries great educative value for Science and Engineering Students.

Object:

To study Decimal to BCD converter.

Features:

The board consists of the following built-in parts :

01. +5V D.C. at 100mA, IC Regulated Power Supply internally connected.
 02. Four, 2-input NAND gates.
 03. One driver circuit to drive LEDs.
 04. Nine switches to enter the decimal data.
 05. LEDs for visual indication of BCD output conditions.
 06. Adequate no. of other Electronic Components.
 07. Mains ON/OFF switch, Fuse and Jewel light.
- * The unit is operative on 230V \pm 10% at 50Hz A.C. Mains.
 - * Strongly supported by detailed Operating Instructions, giving details of Object, Theory, Design procedures, Report Suggestions and Book References.

1024*4 Bit Static Random Access Memory (2114)

Order Code - 38634



Computer Logic Training Board on 1024 X 4 Bit Static Random Access Memory (2114) has been designed specifically to get the familiarization and the operation of Semi conductor Memory. It provides the understanding of read, write & chip enable operation with the help of switches and LEDs. Dynamic operation of the chip can also be understood by connecting the pulse generator at the appropriate terminals. The board is absolutely self contained and requires no other apparatus.

Practical experience on this board carries great educative value for Science and Engineering Students.

Object:

01. To study the Write operation of 1024 X 4 Bit Random Access Memory.
02. To study the Read operation of 1024 X 4 Bit Random Access Memory.
03. To study the Dynamic checking of 1024 X 4 Bit Random Access Memory.

Features:

The board consists of the following built-in parts :

01. +5V D.C. at 100mA, IC Regulated Power Supply internally connected.
 02. Switches to set Data & Address.
 03. LEDs for visual indication of Address used Data conditions.
 04. Adequate no. of other Electronic Components.
 05. Mains ON/OFF switch, Fuse and Jewel light.
- * The unit is operative on 230V \pm 10% at 50Hz A.C. Mains.
 - * Adequate nos. of patch cords stackable from rear both ends 4mm spring loaded plug, length ½ metre
 - * Good Quality, reliable terminal/sockets are provided at appropriate places on panel for connections / observation of waveforms.
 - * Strongly supported by detailed Operating Instructions, giving details of Object, Theory, Design procedures, Report Suggestions and Book References.

Other Apparatus Required (optional):

- * Pulse Generator Order Code 16914 - 2 Nos. (To understand the memory operation in dynamic mode)

Study of EX-OR and EX-NOR Gates

Order Code - 38635



Computer Logic Training Board has been designed specifically for the study of EX-OR and EX-NOR Logic Gates and to verify the truth tables of these logic functions using universal NAND Gates. The board is absolutely self contained and requires no other apparatus.

Practical experience on this board carries great educative value for Science and Engineering Students.

Object:

01. To study the EX-OR logic gate and verify its truth table.
02. To construct the EX-OR logic gate using NAND

- gates and verify its truth table.
- To study the EX-NOR logic gate and verify its truth table.
 - To construct the EX-NOR logic gate using NAND gates and verify its truth table.

Features:

The board consists of the following built-in parts :

- Five, 2-input NAND gates.
 - One, 2-input EX-OR and one 2-input EX-NOR gate.
 - +5V D.C. at 100mA, IC Regulated Power Supply internally connected.
 - Two switches for giving binary inputs.
 - Two LEDs indicators, for checking logic state of output.
 - Adequate no. of other electronic components.
 - Mains ON/OFF switch, Fuse and Jewel light.
- * The unit is operative on 230V ±10% at 50Hz A.C. Mains.
 - * Adequate nos. of patch cords stackable from rear both ends 4mm spring loaded plug, length ½ metre
 - * Good Quality, reliable terminal/sockets are provided at appropriate places on panel for connections / observation of waveforms.
 - * Strongly supported by detailed Operating Instructions, giving details of Object, Theory, Design procedures, Report Suggestions and Book References.

Bilateral Switch

Order Code - 38636

Computer Logic Training Board has been designed specifically for the study of Bilateral Switch. This Training Board gives a better understanding of two way communication interface between data buses. The board is absolutely self contained and requires no other apparatus. Practical experience on this board carries great educative value for Science and Engineering Students.

Object:

To Study Functioning of a Bilateral Switch and to understand two way data communication between 4-bit data buses using IC 74LS243.

Features:

- The board consists of the following built in parts.
- + 5V D.C. at 50mA, IC regulated power supply internally connected.
 - Two Tristate Octal Buffers ICs 74LS244.
 - Quad Bus Transceiver (Bilateral Switch) IC 74LS243.
 - SPDT switches for logic selection.
 - LEDs for visual indication of status.
 - Adequate no. of Electronic Components.
 - Mains ON/OFF switch, Fuse and Jewel light.
- * The unit is operative on 230V ±10% at 50Hz A.C. Mains.
 - * Good Quality, reliable terminal/sockets are provided at appropriate places on panel for connections / observation of waveforms.
 - * Strongly supported by detailed Operating Instructions, giving details of Object, Theory, Design procedures, Report Suggestions and Book References.

8-Bit Analog to Digital (A/D) Converter

Order Code - 38637



Computer Logic Training Board has been designed specifically for the Study of 8-Bit Analog to Digital Converter. This Training Board gives a deep understanding of the conversion of Analog signal into Digital signal using IC ADC 0800, which is based on Successive approximation method of Conversion. Practical experience on this board carries great educative value for Science and Engineering Students.

Object:

To Study Conversion of Analog signal to 8-bit Digital signal using IC ADC 0800.

Features:

- The board consists of the following built-in parts :
- ± 5V D.C. at 50mA, IC regulated power supply internally connected.
 - Timer IC 555.
 - A to D convertor IC ADC 0800.
 - Buffer IC 74240.
 - LEDs for visual indication of status.
 - Adequate no. of Electronic Components.
 - Mains ON/OFF switch, Fuse and Jewel light.
- * The unit is operative on 230V ±10% at 50Hz A.C. Mains.
 - * Good Quality, reliable terminal/sockets are provided at appropriate places on panel for connections / observation of waveforms.
 - * Strongly supported by detailed Operating Instructions, giving details of Object, Theory, Design procedures, Report Suggestions and Book References.

Other Apparatus Required:

- * Digital multimeter 3¾ digit Order Code - 16901

8-Bit Multiplying Digital to Analog Converter

Order Code - 38638



Computer Logic Training Board has been designed specifically for the study of 8-Bit Multiplying D/A Converter. This Training Board gives a better understanding of the conversion of digital signal in to an equivalent analog signal using IC AD1408. Practical experience on this board carries great educative value for Science and Engineering Students.

Object:

To Study 8-Bit Multiplying Digital to Analog Converter with 8-Bit Input Digital Signals and Analog output signal representing the product of Inputs and Reference source.

Features:

The board consists of the following built-in parts :

01. $\pm 15V$ D.C. at 50mA, IC regulated power supply internally connected.
 02. +5V D.C. at 50mA, IC regulated power supply internally connected.
 03. OP-Amp IC 741.
 04. 8-Bit D to A converter IC AD1408.
 05. Voltage Regulator IC 723.
 06. SPDT switches for logic selection/Input Data.
 07. LEDs for visual indication of status/Binary Data Input.
 08. Adequate no. of Electronic Components.
 09. Mains ON/OFF switch, Fuse and Jewel light.
- * The unit is operative on 230V $\pm 10\%$ at 50Hz A.C. Mains.
 - * Good Quality, reliable terminal/sockets are provided at appropriate places on panel for connections / observation of waveforms/voltages.
 - * Strongly supported by detailed Operating Instructions, giving details of Object, Theory, Design procedures, Report Suggestions and Book References.

Other Apparatus Required:

01. Digital multimeter 3¾ digit Order Code - 16901

Presetable Counter

Order Code - 38639



Computer Logic Training Board has been designed specifically for the study of Presetable Counter. This Training Board gives a better understanding of 5-bit counting, starting from a preset initial number and frequency division of clock input by factors of 2, 3, 4, 5, 6, 7, 8, 9 & 10. Practical experience on this board carries great educative value for Science and Engineering Students.

Object:

01. To study beginning of counting for a Preset initial number.
02. To study divide by N programmable counter to give gating pulse of desired duration.

Features:

- The board consists of the following built-in parts :
01. + 10V D.C. at 50mA, IC regulated power supply internally connected.
 02. Timer 555 IC.
 03. Presetable Counter IC 4018.
 04. Two NAND GATE ICs 4011.
 05. SPDT switches for logic selection.
 06. LEDs for visual indication of status.
 07. Adequate no. of Electronic Components.
 08. Mains ON/OFF switch, Fuse and Jewel light.
- * The unit is operative on 230V $\pm 10\%$ at 50Hz A.C. Mains.
 - * Adequate nos. of patch cords stackable from rear both ends 2mm spring loaded plug, length ½ metre.
 - * Good Quality, reliable terminal/sockets are provided at appropriate places on panel for connections / observation of waveforms.

- * Strongly supported by detailed Operating Instructions, giving details of Object, Theory, Design procedures, Report Suggestions and Book References.

Other Apparatus Required:

01. Frequency Counter 6 digit Order Code - 16915
02. Dual Trace Cathode Ray Oscilloscope 20MHz.

Digital Multiplexer (8-Bit)

Order Code - 38640



Computer Logic Training Board has been designed specifically for the study of Digital Multiplexer. This Training Board gives a better understanding of the phenomena of multiplexing with eight input signals and one multiplexed output using three control signals. The board is absolutely self contained and requires no other apparatus. Practical experience on this board carries great educative value for Science and Engineering Students.

Object:

To Study 8-bit Digital Multiplexer with 8 inputs & one multiplexed output using IC 74151.

Features:

- The board consists of the following built-in parts :
01. + 5V D.C. at 50mA , IC regulated power supply internally connected.
 02. Multiplexer IC 74151.
 03. LEDs for visual indication of status.
 04. SPDT switches for logic selection.
 05. Adequate no. of Electronic Components.
 06. Mains ON/OFF switch, Fuse and Jewel light.
- * The unit is operative on 230V $\pm 10\%$ at 50Hz A.C. Mains.
 - * Good Quality, reliable terminal/sockets are provided at appropriate places on panel for connections / observation of waveforms.
 - * Strongly supported by detailed Operating Instructions, giving details of Object, Theory, Design procedures, Report Suggestions and Book References.

1 : 8 Line Demultiplexer (digital)

Order Code - 38641



Computer Logic Training Board has been designed specifically for the study of 1:8 Line Demultiplexer. This Training Board gives a better understanding of the phenomena of demultiplexing with one input demultiplexed to eight outputs using three control inputs (Address). Practical experience on this board carries great educative value for Science and Engineering Students.

Object:

To Study 8-bit 1:8 Line Demultiplexer using IC 74138.

Features:

The board consists of the following built-in parts :

- 01. + 5V DC at 50mA, IC regulated power supply internally connected.
- 02. Demultiplexer IC 74138.
- 03. Timer IC 555.
- 04. SPDT switches for logic selection.
- 05. LEDs for visual indication of status.
- 06. Adequate no. of Electronic Components.
- 07. Mains ON/OFF switch, Fuse and Jewel light.
- * The unit is operative on 230V ±10% at 50Hz A.C. Mains.
- * Good Quality, reliable terminal/sockets are provided at appropriate places on panel for connections / observation of wave forms.
- * Strongly supported by detailed Operating Instructions, giving details of Object, Theory, Design procedures, Report Suggestions and Book References.

Other Apparatus Required

- 01. Dual Trace Cathode Ray Oscilloscope 20MHz

Monoshot Multivibrator

Order Code - 38642



Computer Logic Training Board has been designed specifically for the Study of Monoshot Multivibrator. This Training Board gives a better understanding of monoshot operation on both rising & falling edges of input pulses with different combinations of R & C. Practical experience on this board carries great educative value for Science and Engineering Students.

Object:

To Study Monoshot Multivibrator in both rising edge and falling edge triggering mode with different RC Combinations using CMOS IC4047.

Features:

- The board consists of the following built-in parts :
- 01. + 10V D.C. at 50mA, IC regulated power supply internally connected.
- 02. Monoshot Multivibrator CMOS IC 4047.
- 03. DPDT and single pole three way switches.
- 04. SPDT switches for logic selection.
- 05. Adequate no. of Electronic Components.
- 06. Mains ON/OFF switch, Fuse and Jewel light.
- * The unit is operative on 230V ±10% at 50Hz A.C. Mains.
- * Adequate nos. of patch cords stackable from rear both ends 4mm spring loaded plug, length ½ metre.
- * Good Quality, reliable terminal/sockets are provided at appropriate places on panel for connections / observation of wave forms.
- * Strongly supported by detailed Operating Instructions, giving details of Object, Theory, Design procedures, Report Suggestions and Book References.

Other Apparatus Required

- 01. Function Generator Order Code - 16916
- 02. Dual Trace Cathode Ray Oscilloscope 20MHz

Universal Shift Register

Order Code - 38643



Computer Logic Training Board has been designed specifically for the study of Universal Shift Register. This Training Board gives a better understanding of the concepts of shifting data IN and OUT of a 4-bit register in different modes. The board is absolutely self contained and requires no other apparatus. Practical experience on this board carries great educative value for Science and Engineering Students.

Object:

To Study the shifting of 4 bit data using IC 74LS194 in the following modes:

- 01. Serial Left IN - Serial Left OUT.
- 02. Serial Left IN - Serial Right OUT.
- 03. Serial Right IN - Serial Left OUT.
- 04. Serial Right IN - Serial Right OUT.
- 05. Serial Left IN - Parallel OUT.
- 06. Serial Right IN - Parallel OUT.
- 07. Parallel IN - Serial Left OUT.
- 08. Parallel IN - Serial Right OUT.
- 09. Parallel IN - Serial OUT.

Features:

- The board consists of the following built-in parts :
- 01. + 5V D.C. at 50mA, IC regulated power supply internally connected.
- 02. Universal Register IC 74LS194.
- 03. Transparent latch IC 74LS373.
- 04. JK Flip-flop IC 74LS74
- 05. AND GATE IC 7411.
- 06. NAND GATE IC 7400.
- 07. Adequate no. of Electronic Components.
- 08. Mains ON/OFF switch, Fuse and Jewel light.
- * The unit is operative on 230V ±10% at 50Hz A.C. Mains.
- * Good Quality, reliable terminal/sockets are provided at appropriate places on panel for connections / observation of waveforms.
- * Strongly supported by detailed Operating Instructions, giving details of Object, Theory, Design procedures, Report Suggestions and Book References.

8212 - Single Input/Output (I/O) Port

Order Code - 38644



Computer Logic Training Board has been designed specifically for the study of 8212-Single I/O Port. The board is absolutely self contained and requires no other apparatus. Practical experience on this board carries great

educative value for Science and Engineering Students.

Object:

To Study Input and output modes of IC 8212 I/O Port.

Features:

The board consists of the following built-in parts :

- 01. + 5V D.C. at 50mA, IC regulated power supply internally connected.
- 02. Single I/O port IC 8212.
- 03. Tristate buffer IC 74244.
- 04. Transistor BC 177.
- 05. SPDT switches for logic selection.
- 06. Adequate no. of Electronic Components.
- 07. Mains ON/OFF switch, Fuse and Jewel light.
- * The unit is operative on 230V ±10% at 50Hz A.C. Mains.
- * Good Quality, reliable terminal/sockets are provided at appropriate places on panel for connections / observation of waveforms.
- * Strongly supported by detailed Operating Instructions, giving details of Object, Theory, Design procedures, Report Suggestions and Book References.

8155 Simple Programmable Interface

Order Code - 38651



Computer Logic Training Board has been designed specifically for the study of 8155-Simple Programmable Interface. This Training Board gives a better understanding of memory operations, timer operations and Interfacing between address port & data ports. Practical experience on this board carries great educative value for Science and Engineering Students.

Object:

To Study 8155 simple programmable interface for the following:

- 01. Memory operations in IC 8155.
- 02. Interface operations to configure different ports as input port or output port or in combinations of Input/Output.
- 03. Different modes of Timer Operation.

Features:

The board consists of the following built-in parts :

- 01. + 5V D.C. at 1A, IC regulated power supply internally connected.
- 02. Programmable interface IC 8155.
- 03. Eight tristate buffer ICs 74LS244.
- 04. EPROM IC 2716.
- 05. Timer IC 555.
- 06. OR gate IC 74LS32.
- 07. NAND gate IC 74LS00.
- 08. 4-Bit D type registers (latch) IC 74LS173.
- 09. LEDs for visual indication of status.
- 10. SPDT switches for logic selection.
- 11. Adequate no. of Electronic Components.
- 12. Mains ON/OFF switch, Fuse and Jewel light.
- * The unit is operative on 230V ±10% at 50Hz A.C. Mains.
- * Good Quality, reliable terminal/sockets are

provided at appropriate places on panel for connections / observation of waveforms.

- * Strongly supported by detailed Operating Instructions, giving details of Object, Theory, Design procedures, Report Suggestions and Book References.

Other Apparatus Required:

- * Cathode Ray Oscilloscope 20MHz

8255 Programmable Peripheral Interface

Order Code - 38652



Computer Logic Training Board has been designed specifically for the study of 8255 Programmable Peripheral Interface. This Training Board gives a better understanding of the interfacing between address port & data ports. The board is absolutely self contained and requires no other apparatus. Practical experience on this board carries great educative value for Science and Engineering Students.

Object:

To Study 8255 programmable peripheral interface IC for interface operations to configure different ports as input port or output port or in combination of input/output.

Features:

The board consists of the following built-in parts :

- 01. + 5V D.C. at 3A, IC regulated power supply internally connected.
- 02. Programmable peripheral interface IC 8255.
- 03. Eight Tristate buffer ICs 74LS244.
- 04. NAND gate IC 74LS00.
- 05. OR gate IC 74LS32.
- 06. EPROM IC 2716.
- 07. D-filp-flop IC 74LS173.
- 08. LEDs for visual indication of status.
- 09. SPDT switches for logic selection.
- 10. Adequate no. of Electronic Components.
- 11. Mains ON/OFF switch, Fuse and Jewel light.
- * The unit is operative on 230V ±10% at 50Hz A.C. Mains.
- * Good Quality, reliable terminal/sockets are provided at appropriate places on panel for connections / observation of waveforms.
- * Strongly supported by detailed Operating Instructions, giving details of Object, Theory, Design procedures, Report Suggestions and Book References.

8253 Programmable Timer

Order Code - 38653



Computer Logic Training Board has been designed specifically for the study of 8253 Programmable Timer. This Training Board gives a better understanding of the various modes of operation of

Programmable Timer IC 8253.
Practical experience on this board carries great educative value for Science and Engineering Students.

Object:

To Study of the following different modes of operation of 8253 Programmable Timer :

01. MODE 0 - Interrupt on Terminal Count.
02. MODE 1 - Programmable one shot.
03. MODE 2 - Rate Generator.
04. MODE 3 - Square Wave Generator.
05. MODE 4 - Software Triggered Strobe.
06. MODE 5 - Hardware Triggered Strobe.

Features:

The board consists of the following built-in parts :

01. + 5V D.C. at 500mA, IC regulated power supply internally connected.
 02. Programmable Timer IC 8253.
 03. Timer IC 555.
 04. LEDs for visual indication of status.
 05. SPDT switches for logic selection.
 06. Adequate no. of Electronic Components.
 07. Mains ON/OFF switch, Fuse and Jewel light.
- * The unit is operative on 230V ±10% at 50Hz A.C. Mains.
 - * Good Quality, reliable terminal/sockets are provided at appropriate places on panel for connections / observation of waveforms.
 - * Strongly supported by detailed Operating Instructions, giving details of Object, Theory, Design procedures, Report Suggestions and Book References.

4 Line to 16 Line Decoder / 1 to 16 Demultiplexer

Order Code - 38654



Computer Logic Training Board has been designed specifically for the study of 4 line to 16 line Decoder, 1 to 16 demultiplexer and its application as sequencer. This Training Board gives a better understanding of decoding 4 lines to 16 lines. It also explains the phenomena of Demultiplexing with one input signal and sixteen outputs using four control signals. It gives an idea to sequence among a number of states. The board is absolutely self contained and requires no other apparatus. Practical experience on this board carries great educative value for Science and Engineering Students.

Object:

01. To demonstrate the operation of a 1 line to 16 line demultiplexer.
02. To demonstrate the operation of 4 line to 16 line decoder.
03. To demonstrate how 4 line to 16 line decoder can be used to sequence among any number of states, between one and fifteen. (This is called a programmable sequencer with 4 binary inputs and 16 outputs).

Features:

- The board consists of the following built-in parts :
01. +5VD.C. at 200mA, IC regulated power supply internally connected.
 02. 1 to 16 Decoder/Demultiplexer IC.
 03. LEDs (22 No's) for visual indication of status.
 04. SPDT (6 No's) switches for logic selection.
 05. Adequate no. of other Electronic Components.
 06. Mains ON/OFF switch, Fuse and Jewel light.
- * The unit is operative on 230V ±10% at 50Hz A.C. Mains.
 - * Good Quality, reliable terminal/sockets are provided at appropriate places on panel for connections/ observation of waveforms.
 - * Strongly supported by detailed Operating Instructions, giving details of Object, Theory, Design procedures, Report Suggestions and Book References.

16 Line to 1 Line Multiplexer

Order Code - 38655



Computer Logic Training Board has been designed specifically for the study of 16 line to 1 line multiplexer. This Training Board gives a better understanding of phenomena of multiplexing with sixteen input signals and one output using four control signals. The board is absolutely self contained and requires no other apparatus.

Practical experience on this board carries great educative value for Science and Engineering Students.

Object:

01. To verify the operation of 16 line to 1 line digital multiplexer.
02. To demonstrate how multiplexer can be used to convert a parallel data input to a serial data output device.

Features:

- The board consists of the following built-in parts :
01. +5V DC.at 200 mA.IC regulated power supply internally connected.
 02. 16 input multiplexer IC.
 03. Hex inverter IC.
 04. LEDs (23 No's) for visual indication of status.
 05. SPDT (21 No's) switches for logic selection.
 06. Adequate no. of Electronic Components.
 07. Mains ON/OFF switch, Fuse and Jewel light.
- * The unit is operative on 230V ±10% at 50Hz A.C. Mains.
 - * Good Quality, reliable terminal/sockets are provided at appropriate places on panel for connections / observation of waveforms.
 - * Strongly supported by detailed Operating Instructions, giving details of Object, Theory, Design procedures, Report Suggestions and Book References.

16x4 Bit Static Random Access Memory (7489)

Order Code - 38656



Computer Logic Training Board on 16 X 4 Bit Static Random Access Memory (7489) has been designed specifically to get the familiarization of the operation of semiconductor memory. The unit is self contained and provide the understanding of Read, Write and Chip Enable operation with the help of Switches and LEDs. Dynamic operation of the chip can also be understood by connecting the pulse generator at the appropriate terminals. A built in logic indication is also provided on the training board to check the logic state of various pins of the memory chip. Practical experience on this board carries great educative value for Science and Engineering Students.

Object:

To study Operation of a 16 X 4 Bit Static Random Access Memory.

Features:

The board consists of the following built-in parts :

01. + 5V D.C. at 50mA, IC regulated power supply internally connected.
 02. Switches to set the memory data and address.
 03. LEDs for visual indication of output data (Read out).
 04. Logic indication terminal to provide the facility to check the logic state of various pins of IC.
 05. Adequate no. of other Electronic Components.
 06. Mains ON/OFF switch, Fuse and Jewel light.
- * The unit is operative on 230V ±10% at 50Hz A.C. Mains.
 - * Good Quality, reliable terminal/sockets are provided at appropriate places on panel for connections/ observation of waveforms.
 - * Strongly supported by detailed Operating Instructions, giving details of Object, Theory, Design procedures, Report Suggestions and Book References.

1024 X 1 Bit Static Random Access Memory (2102)

Order Code - 38657



Computer Logic Training Board on 1024 X 1 Bit Static Random Access Memory (2102) has been designed specifically to get the familiarization of the operation of static MOS memory. The unit is self contained and provide the understanding of Read, Write and Chip Enable operation with the help of switches and LEDs. Dynamic operation of the chip can also be understood by connecting the pulse generator at the appropriate terminal. Practical experience on this board carries great educative value for Science and Engineering Students.

Object:

To study Operation of a 1024 X 1 Bit Static Random Access Memory.

Features:

The board consists of the following built-in parts :

01. + 5V D.C. at 50mA, IC regulated power supply

internally connected.

02. Switches to set the memory data and address.
 03. LEDs for visual indication of output data (read out).
 04. Logic indication terminal provided to check the logic state of various pins of IC.
 05. Adequate no. of other Electronic Components.
 06. Mains ON/OFF switch, Fuse and Jewel light.
- * The unit is operative on 230V ±10% at 50Hz A.C. Mains.
 - * Adequate nos. of patch cords stackable from rear both ends 4mm spring loaded plug, length ½ metre
 - * Good Quality, reliable terminal/sockets are provided at appropriate places on panel for connections / observation of waveforms.
 - * Strongly supported by detailed Operating Instructions, giving details of Object, Theory, Design procedures, Report Suggestions and Book References.

Other Apparatus Required (optional):

01. Pulse Generator Order Code - 16914: 2 nos. (Optional, to understand the memory operation in dynamic mode).

Digital Demultiplexer

Order Code - 38658



Computer Logic Training Board has been designed specifically to familiarise the operation of a demultiplexer circuits. In digital system the technique of multiplexer and demultiplexers are frequently used to reduce the system cost and to improve the reliability. The unit provides the understanding of two output demultiplexers. This concept can be extended to make the demultiplexers for more complex circuits. The unit is absolutely self contained and requires no other apparatus.

Practical experience on this board carries great educative value for Science and Engineering Students.

Object:

To study the operation of a Digital Demultiplexer circuit

Features:

The unit consists of the following built-in parts :

01. +5V D.C. at 50mA, IC Regulated Power Supply internally connected.
 02. Two switches to set the input and control bits.
 03. Two LEDs for visual indication of selected line.
 04. A separate LED provides the indication of logic level of any pin of IC.
 05. Adequate no. of other electronic components.
 06. Mains ON/OFF switch, fuse and Neon Indicator are provided.
- * The unit is operative on 230V ±10% at 50Hz A.C. Mains.
 - * Adequate nos. of patch cords stackable from rear both ends 4mm spring loaded plug, length ½ metre
 - * Good Quality, reliable terminal/sockets are provided at appropriate places on panel for connections / observation of waveforms.

Decimal to BCD (Binary Coded) Encoder Using Diode Matrix

Order Code - 38659



Computer Logic Training Board has been designed specifically for the study of Decimal to BCD Encoder using Diode Matrix. This Training Board gives a better understanding of the phenomenon of encoding with decimal input and BCD (binary coded) output using diodes. The board is absolutely self contained and requires no other apparatus.

Practical experience on this board carries great educative value for Science and Engineering Students.

Object:

To demonstrate conversion of Decimal to BCD (binary coded) using diode matrix encoder.

Features:

The board consists of the following built-in parts :

- 01. +5V D.C. at 200mA, IC regulated power supply internally connected.
- 02. Diodes arranged in matrix.
- 03. LEDs (14 No's) for visual indication of status.
- 04. 'Push to ON' (10 No's) switches for decimal selection.
- 05. Adequate no. of Electronic Components.
- 06. Mains ON/OFF switch, Fuse and Jewel light.
- * The unit is operative on 230V ±10% at 50Hz A.C. Mains.
- * Good Quality, reliable terminal/sockets are provided at appropriate places on panel for connections / observation of waveforms.
- * Strongly supported by detailed Operating Instructions, giving details of Object, Theory, Design procedures, Report Suggestions and Book References.

Study of Parity Circuits

Order Code - 38660



Computer Logic Training Board has been designed specifically for the study of Parity circuits. This Training Board gives a better understanding of checking & generation of Parity. It has 8-bit binary input, one output for checking parity and another 9-bit output with generated odd or even parity. The board is absolutely self contained and requires no other apparatus.

Practical experience on this board carries great educative value for Science and Engineering Students.

Object:

- 01. Verification of even parity or odd parity by using EX-OR gates (parity checker).
- 02. To generate odd and even parity (parity generator).

Features:

The board consists of the following built-in parts :

- 01. +5V D.C. at 200mA, IC regulated power supply internally connected.
- 02. Two, Quad 2-Input Exclusive OR gate IC's .
- 03. Hex Inverter IC.
- 04. LEDs (24 No's) for visual indication of status.
- 05. SPDT (9 No's) switches for logic selection.
- 06. Adequate no. of other Electronic Components.
- 07. Mains ON/OFF switch, Fuse and Jewel light.
- * The unit is operative on 230V ±10% at 50Hz A.C. Mains.
- * Good Quality, reliable terminal/sockets are provided at appropriate places on panel for connections / observation of waveforms.
- * Strongly supported by detailed Operating Instructions, giving details of Object, Theory, Design procedures, Report Suggestions and Book References.

NAND Gate Encoder [Decimal To BCD (Binary Coded)]

Order Code - 38661



Computer Logic Training Board has been designed specifically for the study of NAND gate Encoder, to encode Decimal number to BCD(binary coded) equivalent. This Training Board gives a better understanding of the phenomena of encoder using four input NAND gates with ten decimal inputs and 4-bit binary output. The board is absolutely self contained and requires no other apparatus.

Practical experience on this board carries great educative value for Science and Engineering Students.

Object:

To demonstrate decimal to BCD (binary coded) encoder using 4-input NAND gates and verify the encoding.

Features:

- The board consists of the following built-in parts :
- 01. +5V D.C. at 200mA, IC regulated power supply internally connected.
- 02. Three, Dual 4- Input NAND gate ICs.
- 03. LEDs (14 nos.) for visual indication of status.
- 04. Miniature SPDT switches (10 nos.) for Input selection.
- 05. Adequate no. of other Electronic Components.
- 06. Mains ON/OFF switch, Fuse and Jewel light.
- * The unit is operative on 230V ±10% at 50Hz A.C. Mains.
- * Good Quality, reliable terminal/sockets are provided at appropriate places on panel for connections / observation of waveforms.
- * Strongly supported by detailed Operating Instructions, giving details of Object, Theory, Design procedures, Report Suggestions and Book References.

4-Bit Binary Decade UP/down Counter Using IC

Order Code - 38662



Computer Logic Training Board has been designed specifically for the study of 4-bit binary UP/DOWN counter. This Training Board gives a better understanding of counter using 4-bit presetable inputs, one master reset and parallel load with 4-bit BCD output. The board is absolutely self contained and requires no other apparatus.

Practical experience on this board carries great educative value for Science and Engineering Students.

Object:

To study the following using IC :

- 01. Up counting (0 – 9).
- 02. Down counting (9 – 0).
- 03. Presetting of inputs and study count sequence.

Features:

The board consists of the following built-in parts :

- 01. +5V D.C. at 200mA, IC regulated power supply internally connected.
- 02. 4-bit presetable BCD decade up/down counter IC.
- 03. Quad 2-input NAND gate IC.
- 04. LEDs for visual indication of status.
- 05. SPDT, DPDT and micro switches for logic selection.
- 06. Adequate no. of other Electronic Components.
- 07. Mains ON/OFF switch, Fuse and Jewel light.
- * The unit is operative on 230V ±10% at 50Hz A.C. Mains.
- * Good Quality, reliable terminal/sockets are provided at appropriate places on panel for connections/ observation of waveforms.
- * Strongly supported by detailed Operating Instructions, giving details of Object, Theory, Design procedures, Report Suggestions and Book References.

Construction of Multivibrators Using Digital IC

Order Code - 38663



Computer Logic Training Board has been designed specifically for the study of Bistable, Monostable & Astable multivibrators using digital IC. This Training Board gives a better understanding of the concepts involved in construction of multivibrators and their properties. The board is absolutely self contained and requires no other apparatus.

Practical experience on this board carries great educative value for Science and Engineering Students.

Object:

To design and demonstrate the operation of the following using digital IC :-

- 01. Astable multivibrator.
- 02. Monostable multivibrator.
- 03. Bistable multivibrator.

Features:

The board consists of the following built-in parts :

- 01. +5V D.C. at 200mA, IC regulated power supply internally connected.
- 02. Quadruple 2-input NOR gate IC.
- 03. LED for visual indication of status.
- 04. Two 'Push to ON' switches for triggering.
- 05. Adequate no. of other Electronic Components.

- 06. Mains ON/OFF switch, Fuse and Jewel light.
- * The unit is operative on 230V ±10% at 50Hz A.C. Mains.
- * Good Quality, reliable terminal/sockets are provided at appropriate places on panel for connections /observation of waveforms.
- * Strongly supported by detailed Operating Instructions, giving details of Object, Theory, Design procedures, Report Suggestions and Book References.

Dual Nature of Logic Gates

Order Code - 38664



Computer Logic Training Board has been designed specifically for the study of Dual Nature of Logic Gates. This Training Board gives a better understanding of the phenomena of duality with the help of verification of truth tables of Dual gates. This board also explains combinational logic function Boolean variables and generation of truth tables. The board is absolutely self contained and requires no other apparatus.

Practical experience on this board carries great educative value for Science and Engineering Students.

Object:

- 01. To demonstrate a combinational logic function and to provide practice in using Boolean variables.
- 02. To provide practice in evaluating a truth table.
- 03. To verify dual nature of logic gates.

Features:

The board consists of the following built-in parts :

- 01. +5V D.C. at 200 mA, IC regulated power supply internally connected.
- 02. Quad 2-Input OR Gate IC.
- 03. Quad 2-input AND Gate IC.
- 04. Hex inverter IC.
- 05. Quad 2-input NAND Gate IC.
- 06. Quad 2-input NOR Gate IC.
- 07. LEDs for visual indication of status.
- 08. SPDT switches for logic selection.
- 09. Adequate no. of other Electronic Components.
- 10. Mains ON/OFF switch, Fuse and Jewel light.
- * The unit is operative on 230V ±10% at 50Hz A.C. Mains.
- * Good Quality, reliable terminal/sockets are provided at appropriate places on panel for connections /observation of waveforms.
- * Strongly supported by detailed Operating Instructions, giving details of Object, Theory, Design procedures, Report Suggestions and Book References.

4-Bit Binary Full Adder and Subtractor

Order Code - 38665



Computer Logic Training Board has been designed specifically for the study of phenomena of addition and subtraction of 4-bit binary numbers using 4-bit

arithmetic and complementary techniques. This Training Board uses controlled inverter and full adders to carry out the operations of addition and subtraction. The board is absolutely self contained and requires no other apparatus.

Practical experience on this board carries great educative value for Science and Engineering Students.

Object:

To study the operation of 4-bit binary full adder and subtractor for :

01. Addition of two 4-bit binary numbers.
02. Subtraction of two 4-bit binary numbers.

Features:

The board consists of the following built-in parts :

01. +5V D.C. at 200mA, IC regulated power supply internally connected.
 02. 4-bit full adder IC.
 03. Quad 2-input Ex-OR Gate IC.
 04. LEDs for visual indication of status.
 05. SPDT switches for logic selection.
 06. Adequate no. of other electronic components.
 07. Mains ON/OFF switch, fuse and Neon Indicator are provided.
- * The unit is operative on 230V ±10% at 50Hz A.C. Mains.
 - * Adequate nos. of patch cords stackable from rear both ends 4mm spring loaded plug, length ½ metre
 - * Good Quality, reliable terminal/sockets are provided at appropriate places on panel for connections / observation of waveforms.
 - * Strongly supported by detailed Operating Instructions, giving details of Object, Theory, Design procedures, Report Suggestions and Book References.

Binary Multiplier

Order Code - 38666



Computer Logic Training Board has been designed specifically for the study of Binary Multiplication. This Training Board gives a better understanding of binary multiplication using combinational logic gates, for a two bit by two bit multiplication. The board is absolutely self contained and requires no other apparatus.

Practical experience on this board carries great educative value for Science and Engineering Students.

Object:

To demonstrate Binary multiplier using combinational logic gates by verifying truth table for a two bit by two bit multiplier and compare the binary and decimal multiplication tables.

Features:

The board consists of the following built-in parts :

01. +5V D.C. at 200mA, IC regulated power supply internally connected.
02. Two, Quad 2-input AND gate ICs .
03. Quad 2-input EX-OR Gate IC.
04. LEDs for visual indication of status.
05. SPDT switches for logic selection.
06. Adequate no. of Electronic Components.

07. Mains ON/OFF switch, Fuse and Jewel light.

- * The unit is operative on 230V ±10% at 50Hz A.C. Mains.
- * Good Quality, reliable terminal/sockets are provided at appropriate places on panel for connections / observation of waveforms.
- * Strongly supported by detailed Operating Instructions, giving details of Object, Theory, Design procedures, Report Suggestions and Book References.

Audible Logic Probe Using Timer IC

Order Code - 38667



Computer Logic Training Board has been designed specifically for the study of Audible Logic Probe using Timer IC. It produces a high frequency signal tone when its tip sense high signal, low frequency tone when its tip sense signal is low and a warbling tone (highlow-high...) When encountering a pulse train. This training board gives a better understanding of the concepts involved in construction of Audible Logic Probe and their properties.

The board is absolutely self contained and requires no other apparatus. Practical experience on this board carries great educative value for Science and Engineering Students.

Object

To study of constructional and operational features of Audible Logic Probe using timer IC. (for TTL and CMOS Ics).

Features:

- The board consists of the following built-in parts :
01. +5V & +12V D.C. at 100mA, IC regulated power supply internally connected.
 02. 0-12V D.C. at 20mA, continuously variable power supply also provided.
 03. Digital panel meter (for measurement of DC voltage)

Specifications:

- Voltage Range : 0-19.99 volt.
- Resolution : 10mV.
- Accuracy : ± 0.2% ± 1 digit.
- I/P Impedance : 10 M ohms.
- Display : 3½ digit, 7 segment LED (12.5mm height)
- Auto : Polarity indication.
- Over Load Indication : Sign of 1 on left and blanking of other digits.

04. Timer IC.
 05. Quad Comparator IC.
 06. Speaker (8W) for output.
 07. Selector switch is provided to select the audible Logic Probe for checking the voltage level of TTL and CMOS ICs.
 08. Adequate no. of other Electronic Components.
 09. Mains ON/OFF switch and Fuse.
- * The unit is operative on 230V ±10% at 50Hz A.C. Mains.
 - * Good Quality, reliable terminal/sockets are provided at appropriate places on panel for

connections / observation of waveforms.

- * Strongly supported by detailed Operating Instructions, giving details of Object, Theory, Design procedures, Report Suggestions and Book References.

Binary to Gray And Gray to Binary Converter

Order Code - 38668



Computer Logic Training Board has been designed specifically for the study of Binary to Gray & Gray to Binary code conversion. The board is absolutely self contained and requires no other apparatus. Practical experience on this board carries great educative value for Science and Engineering Students.

Object:

01. To study of Binary to Gray code conversion.
02. To study of Gray to Binary code conversion.

Features:

The board consists of the following built-in parts :

01. 5V D.C. at 100mA, IC regulated power supply.
 02. Quad 2-input Ex-OR gate.
 03. Switch for code selection.
 04. Switches for logic selection
 05. LEDs for visual indication of status.
 06. Adequate no. of other Electronic Components.
 07. Mains ON/OFF switch, Fuse and Jewel light.
- * The unit is operative on 230V $\pm 10\%$ at 50Hz A.C. Mains.
 - * Good Quality, reliable terminal/sockets are provided at appropriate places on panel for connections/ observation of waveforms.
 - * Strongly supported by detailed Operating Instructions, giving details of Object, Theory, Design procedures, Report Suggestions and Book References.

Open Collector Wire-or & Wire-AND Connection

Order Code - 38669



Computer Logic Training Board has been designed specifically for the study of open collector, wire-OR & wire-AND connections. The board is absolutely self contained and requires no other apparatus practical experience on this board carries great educative value for Science and Engineering Students.

Object:

01. To study open collector gates.
02. To study the logic function of
 - Wire-OR connection of logic gates.
 - Wire-AND connection of logic gates.

Features:

The board consists of the following built in parts :

01. 5V DC at 100mA IC regulated power supply internally connected.
 02. Quad, 2-input NAND gate (open collector) IC.
 03. Four SPDT Switches for logic selection.
 04. LEDs for visual indication of status.
 05. Adequate no. of other electronic components.
 06. Mains ON/OFF switch, fuse and jewel light.
- * Unit is operative on 230V $\pm 10\%$ at 50Hz AC mains.
 - * Good quality, reliable terminals/sockets are provided at appropriate places on panel for connections/observations.
 - * Strongly supported by detailed Operating Instructions, giving details of Object, Theory, Design procedures, Report Suggestions and Book References.

Interfacing Cmos To TTL& TTLTo Cmos Ic's

Order Code - 38670



Computer Logic Training Board has been designed specifically for the study of Interfacing CMOS to TTL and TTL to CMOS IC's. The board is absolutely self contained and requires no other apparatus. Practical experience on this board carries great educative value for Science and Engineering Students.

Object:

01. To study interfacing of TTL IC to CMOS IC.
02. To study interfacing of CMOS IC to TTL IC.

Features:

The board consists of the following built in parts :

01. 5V D.C. at 30mA IC regulated Power Supply.
 02. 12V D.C. at 30mA IC regulated Power Supply.
 03. 0-12V D.C. At 30mA continuously variable regulated Power Supply.
 04. Quad, 2-input NAND gate TTL IC.
 05. Quad, 2-input NAND gate (open collector) TTL IC.
 06. Quad, 2-input NAND gate CMOS IC.
 07. Transistor and adequate no. of other electronic components.
 08. Mains ON/OFF switch, fuse and Neon Indicator are provided.
- * The unit is operative on 230V $\pm 10\%$ at 50Hz A.C. Mains.
 - * Adequate nos. of patch cords stackable from rear both ends 4mm spring loaded plug, length 1/2 metre
 - * Good Quality, reliable terminal/sockets are provided at appropriate places on panel for connections / observation of waveforms.
 - * Strongly supported by detailed Operating Instructions, giving details of Object, Theory, Design procedures, Report Suggestions and Book References.

Characteristics of CMOS IC

Order Code - 38671



Computer Logic Training Board has been designed specifically to study the characteristics of CMOS IC. The board is absolutely self contained and requires no other apparatus.

Practical experience on this board carries great educative value for Science and Engineering Students.

Object:

01. To study the operation and characteristics of a CMOS inverter.
 - Switching characteristics
 - Current sourcing characteristics of a CMOS inverter
 - Current sinking characteristics of a CMOS inverter
 - Paralleling of outputs (current sourcing)
 - Paralleling of outputs (current sinking)
02. To study the operation and characteristics of a 2-input NOR gate.
03. To study the operation and characteristics of a 2-input NAND gate.

Features:

The board consists of the following built in parts :

01. 9V D.C. at 30mA IC regulated Power Supply.
02. Digital Voltmeter 3½ digit having range 20V D.C
03. Digital Milliammeter 3½ digit having range 200mA D.C.
04. Quad, 2-input NOR gate IC.
05. Quad, 2-input NAND gate IC.
06. Potentiometer for varying input voltage to CMOS IC
07. Adequate no. of other electronic components.
08. Main ON/OFF switch and fuse.
 - * Unit is operative on 230±10% at 50Hz ac mains.
 - * Adequate nos. of patch cords stackable 4mm spring loaded plug, length ½ metre
 - * Good quality, reliable terminals/Sockets are provided at appropriate places on panel for connections/observations.
 - * Strongly supported by detailed Operating Instructions, giving details of Object, Theory, Design procedures, Report Suggestions and Book References.

Verification of Excess-3 to Decimal Converter

Order Code - 38672



Computer Logic Training Board has been designed specifically for the verification of Excess-3 to Decimal converter. The board is absolutely self contained and requires no other apparatus.

Practical experience on this board carries great educative value for Science and Engineering Students.

Object:

To verify Excess-3 to Decimal converter.

Features:

- The board consists of the following built in parts :
01. 5V D.C. at 100mA IC regulated Power Supply internally connected.
 02. Two, Quad, 2-input NAND gate IC
 03. Hex inverter IC

04. Two, Tripple, 3-input NAND gate IC
05. BCD to Decimal Decoder IC
06. SPDT switches for logic selection.
07. LEDs for visual indication of status.
08. Mains ON/OFF switch, fuse and jewel light.
 - * The Unit is operative on 230±10% at 50Hz ac mains.
 - * Adequate nos. of patch cords stackable 4mm spring loaded plug, length ½ metre
 - * Good quality, reliable terminals/Sockets are provided at appropriate places on panel for connections/observations.
 - * Strongly supported by detailed Operating Instructions, giving details of Object, Theory, Design procedures, Report Suggestions and Book References.

60Hz Clock Pulse Generator (Using IC 5369)

Order Code - 38673



Computer Logic Training Board has been designed specifically for construction of 60Hz, 10Hz and 1Hz using IC 5369 and observe the output of 60Hz, 10Hz and 1Hz.

Practical experience on this board carries great educative value for Science and Engineering Students.

Object:

To construct 60Hz, 10Hz & 1Hz using IC 5369 and observe the output of 60Hz, 10Hz & 1Hz.

Features:

- The board consists of the following built in parts :
01. 5V D.C. at 50mA IC regulated Power Supply internally connected.
 02. IC precision time base for digital clock.
 03. Two, Decade counter ICs.
 04. Crystal of frequency 3.58 MHz
 05. Adequate no. of other electronic components.
 06. Mains ON/OFF switch, fuse and jewel light.
 - * The Unit is operative on 230±10% at 50Hz AC mains.
 - * Good quality, reliable terminals/Sockets are provided at appropriate places on panel for connections/observations.
 - * Strongly supported by detailed Operating Instructions, giving details of Object, Theory, Design procedures, Report Suggestions and Book References.

Other Apparatus Required:

01. Digital frequency counter Order Code - 16915.
02. Cathode Ray Oscilloscope 20MHz.

BCD to Binary Converter

Order Code - 38674

Computer Logic Training Board has been designed specifically for the study of BCD to Binary conversion. The board is absolutely self contained and requires no other apparatus.

Practical experience on this board carries great educative value for Science and Engineering Students.

Object:

To study of BCD to Binary conversion.

Features:

The board consists of the following built-in parts :

01. 5V D.C. at 200mA, IC regulated power supply.
 02. Two, BCD to Binary Convertor ICs.
 03. 8, SPDT switch for logic selection.
 04. One, SPDT switch for Enable/Disable.
 05. 15, LEDs for visual indication of input and output status.
 06. Adequate no. of other Electronic Components.
 07. Mains ON/OFF switch, Fuse and jewel light.
- * The unit is operative on 230V \pm 10% at 50Hz A.C. Mains.
 - * Good Quality, reliable terminal/sockets are provided at appropriate places on panel for voltage measurements.
 - * Strongly supported by detailed Operating Instructions, giving details of Object, Theory, Design procedures, Report Suggestions and Book References.

4 Bit Magnitude Comparator

Order Code - 38675



Computer Logic Training Board has been designed specifically for the study of 4 Bit magnitude comparator (IC7485). Practical experience on this board carries great educative value for Science and Engineering Students.

Object:

01. To understand logic system of IC 7485.
02. To study how to connect it with other components.

Features:

The board consists of the following built-in parts :

01. 5V DC at 100mA, IC Regulated built in Power Supply.
 02. Toggle switch SPDT and LED have been provided for input simulation.
 03. For output of IC, three LED have been provided for these logic states.
 04. 4 bit magnitude comparator IC.
 05. Mains ON/OFF switch, Fuse and jewel light.
- * Good Quality, reliable terminal/sockets are provided at appropriate places on panel for voltage measurements.
 - * Strongly supported by detailed Operating Instructions, giving details of Object, Theory, Design procedures, Report Suggestions and Book References.

Dual 4 Line to 1 Line Multiplexer

Order Code - 38676



Computer Logic Training Board has been designed

specifically for the study of Dual 4 Line to 1Line Multiplexed output. The board is absolutely self contained and requires no other apparatus. Practical experience on this board carries great educative value for science and Engineering students.

Object:

To study Dual Four Line to One Line multiplexed out put using.

Features:

The board consists of the following :

01. 5V DC at 100mA, IC Regulated Power Supply internally connected.
 02. Dual 4 Line to 1 Line Multiplexer IC.
 03. 14 LEDs for visual indication of logic status.
 04. 12 SPDT switches for Logic selection.
 05. Circuit of the IC displayed on the panel for better understanding.
 06. Adequate no. of other Electronic Components.
 07. Mains ON/OFF switch, Fuse & Jewel light.
- * The unit is operative on 230V \pm 10% at 50Hz AC Mains.
 - * Good Quality, reliable terminal/sockets are provided at appropriate places on panel for connections/ observation of waveforms.
 - * Strongly supported by detailed Operating Instructions, giving details of Object Theory, Design procedures, Report Suggestions and Book References.

Dual 1 Line to 4 Line Emultiplexer

Order Code - 38677



Computer Logic Training Board has been designed specifically for the study of Dual 1 Line to 4 Line Demultiplexer. The Training board gives a understanding of the phenomena of demultiplexing with DUAL one input (STROBE DATA) demultiplexed to four outputs using two control inputs (Address). Practical experience on this board carries a great educative value for Science and Engineering students.

Object:

To study DUAL one line to four line Demultiplexer.

Feature:

The board consists of the following built in parts :

01. +5V DC at 100 mA IC Regulated Power Supply internally connected.
 02. Demultiplexer IC.
 03. 6 SPDT switches for Logic selections.
 04. 14 LEDs for visual indications of the status.
 05. Adequate no. of other Electronic Components.
 06. Mains ON/OFF switch, Fuse & Jewel light.
- * The unit is operative on 230V \pm 10% at 50Hz AC Mains.
 - * Good Quality, reliable terminal/sockets are provided at appropriate places on panel for connections/ observation of waveforms.
 - * Strongly supported by detailed Operating Instructions, giving details of Object Theory, Design procedures, Report Suggestions and Book

References.

Octal to Binary Encoder

Order Code - 38678



Computer Logic Training Board has been designed specifically for the study of Octal to Binary Encoder. The Training board gives a understanding of the phenomena which encodes 8 data lines (Octal) to 3 lines binary encoder. The board is absolutely self contained and requires no other apparatus. Practical experience on this board carries a great educative value for science and Engineering students.

Object:

To Study of Octal to Binary Encoder.

Feature:

The board consists of the following built in parts :

01. +5V DC at 100 mA, IC Regulated Power Supply internally connected.
02. 8 Data lines to 3 lines IC-74148.
03. 9 SPDT switches for Logic selections.
04. 14 LEDs for visual indications of the status.
05. Adequate no. of other Electronic Components.
06. Mains ON/OFF switch, Fuse & Jewel light.
- * The unit is operative on 230V \pm 10% at 50Hz AC Mains.
- * Good Quality, reliable terminal/sockets are provided at appropriate places on panel for connections/ observation of waveforms.
- * Strongly supported by detailed Operating Instructions, giving details of Object Theory, Design procedures, Report Suggestions and Book References.

BCD to Seven Segment Display

Order Code - 38679



BCD to Segment Display Seven Segment Display (using Light Emitting Diodes). The decoder driver circuit is used to drive its binary coded decimal output from switches. The BCD to seven segment decoder driver IC 7446/47A which consists of 45 diodes, 16 resistors and 7 transistors.

There are 4 switches corresponding to 4 variables A,B,C and D. The switches are so connected that the two terminals of the switch corresponds to a logic '1' and logic '0' respectively in one position of the switch. When the switch position is changed, the two terminals just inter-change their A,B,C and D both in the true form, as well as in the false form. Thus depending upon the state of the switches and their relative position a particular digit is displayed on the display panel.

Object:

To demonstrate the working of BCD to seven segment display.

Features:

The board consists of the following built-in parts :

01. + 5V at 100mA, IC regulated Power Supply.
02. Seven segment display of Common Anode, LED type.
03. Decoder Driver IC.
04. Four SPDT switches corresponding to four variables A, B, C and D for giving logic '1' and logic '0' inputs.
05. Adequate no. of other Electronic Components.
06. The unit is operative on 230V \pm 10% at 50Hz A.C. Mains.
07. Mains ON/OFF switch and Neon indicator are provided.
- * The unit is operative on 230V \pm 10% at 50Hz AC Mains.
- * Good Quality, reliable terminal/sockets are provided at appropriate places on panel for connections/ observation of waveforms.
- * Strongly supported by detailed Operating Instructions, giving details of Object Theory, Design procedures, Report Suggestions and Book References.

Hexadecimal to Binary Encoder

Order Code - 38681



Computer Logic Training Board has been designed specifically for the study of Hexadecimal to Binary Encoder. The training board gives a understanding of the phenomena which encodes 16 data lines to 4 lines binary encoder. The board is absolutely self contained and requires no other apparatus.

Practical experience on this board carries a great educative value for science and Engineering students.

Object:

Study of Hexadecimal to Binary Encoder.

Features:

The board consists of the following built in parts :

01. + 5 V DC at 100 mA, IC Regulated Power Supply internally connected.
02. 16 data lines to 4 lines ICs.
03. 16 SPDT switches for logic selections.
04. 20 LEDs for visual indications of the status.
05. Adequate no. of other Electronic Components.
06. Mains ON/OFF switch, Fuse & Jewel light.
- * The unit is operative on 230V \pm 10% at 50Hz AC Mains.
- * Good Quality, reliable terminal/sockets are provided at appropriate places on panel for testing / observation of waveforms.
- * Strongly supported by detailed Operating Instructions, giving details of Object, Theory, Design procedures, Report Suggestions and Book References.

Divide By 12 - Counter Using IC-74177

Order Code - 38682



Computer Logic Training Board has been designed specifically for the study of Divide by 12-Counter Using IC 74177.

Practical experience on this board carries a great educative value for science and Engineering students.

Object:

To Measure Clock Frequency using Divide by 12 Counter.

Features:

The board consists of the following built in parts :

01. + 5 V DC at 100 mA, IC Regulated Power Supply internally connected.
02. Divide by 12 counter IC 74177 and dual 4 - input NAND Gate IC 7420.
03. Adequate no. of other Electronic Components.
04. Mains ON/OFF switch, Fuse & Jewel light.
 - * The unit is operative on 230V $\pm 10\%$ at 50Hz AC Mains.
 - * Good Quality, reliable terminal/sockets are provided at appropriate places on panel for voltage measurements.
 - * Strongly supported by detailed Operating Instructions, giving details of Object, Theory, Design procedures, Report Suggestions and Book References.

Other Apparatus Required:

01. AF / RF Generator Order Code - 16917.
02. Frequency Counter Order Code - 16904/ 16915.

Decoding and Display of the Output from IC 7490

Order Code - 38683

Computer Logic Training Board has been designed specifically for the decoding and display of the output from ICs 7490. This Training Board gives students an idea about Decade Counters. The output of counter can be observed in decimal code with the help of decoder and seven segment display which are provided on the panel. The board is absolutely self contained and requires no other apparatus.

Practical experience on this board carries great educative value for Science and Engineering Students.

Object:

01. To study Decoding and display of the output using IC 7490 in 2 X 5 mode.
02. To study Decoding and display of the output using IC 7490 in 5 X 2 mode.

Features:

The board consists of the following built-in parts :

01. +5V D.C. at 100mA, IC Regulated Power Supply.
02. Decade Counter IC 7490.
03. Two digit Seven segment display with decoder circuit to display the output in decimal.
04. One Pulser to provide clock.

05. Switches for logic selection.

06. Mains ON/OFF switch, Fuse and Jewel light.

- * The unit is operative on 230V $\pm 10\%$ at 50Hz A.C. Mains.
- * Adequate nos. of patch cords stackable from rear both ends 4mm spring loaded plug, length $\frac{1}{2}$ metre
- * Good Quality, reliable terminal/sockets are provided at appropriate places on panel for connections / observation of waveforms.
- * Strongly supported by detailed Operating Instructions, giving details of Object, Theory, Design procedures, Report Suggestions and Book References.

Karnaugh Mapping Applications

Order Code - 38684

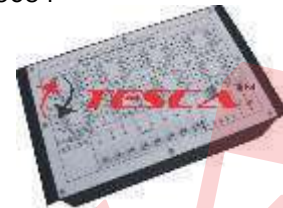

Training Board Of Karnaugh Mapping Applications. The karnaugh map is the simplest and commonly used method to simplify the boolean expressions. It can be used up to six variables.

Object:

01. To simplify any given boolean function of four variables using karnaugh mapping.
02. Designing & Implementation of two level circuits.

Features:

The board consists of the following built-in parts :

01. D.C. supply : +5v at 200 mA IC Regulated power supply.
02. Logic Inputs : Eight independent logic level inputs to select High / Low TTL levels, each with a LED to indicate high / low status and termination.
03. Logic Indicator : Two independent logic level indicators for High / Low status indication of digital outputs.
04. IC's on Panel : 2 Input AND Gate IC-7408
 - : 3 Input AND Gate IC-7411
 - : 2 Input NAND Gate IC-7400
 - : 3 Input NAND Gate IC-7410
 - : 2 Input OR Gate IC-7432
 - : 3 Input OR Gate IC-4075
 - : 2 Input NOR Gate IC-7402
 - : 3 Input NOR Gate IC-7427
05. Seven segment decoder : One BCD to Seven Segment Decoder/ Driver IC with termination.
06. Adequate no. of other electronic Components.
07. The unit is operative on 230v $\pm 10\%$ at 50 Hz A.C. mains.
08. Mains ON / OFF Switch and LED indicator are provided.
 - * Adequate nos. of patch cords stackable 2mm spring loaded plug, length $\frac{1}{2}$ metre
 - * Good Quality, reliable terminal/sockets are provided at appropriate places on panel for connections / observation of waveforms.
 - * Strongly supported by detailed Operating Instructions, giving details of Object, Theory, Design procedures, Report Suggestions and Book References.

Simulator Logic

Order Code - 38685



Logic Simulator (TTL) / Logic Trainer Board has been designed specifically to make the students familiar with the study of ICs and verification of the truth table of logic gates, flip-flops, Gates. Practical experience on this trainer/board carries great educative value for Science and Engineering Students

Specifications:

- * OUTPUT D. C. VOLTAGE : Fixed 5V
- * OUTPUT CURRENT : 200mA
- * LOAD REGULATION : $\pm 1\%$ of the highest specified output voltage (NO LOAD TO FULL LOAD)
- * RIPPLE AND NOISE : less than 2mV
- * LOGIC INPUTS : 10 switches for High/Low
- * OUTPUT INDICATORS : 10mm bright Red LEDs
- * INPUT VOLTAGE : 230V $\pm 10\%$ at 50 Hz AC Mains
- * Strongly supported by detailed Operating Instructions, giving details of Object, Theory, Design procedures, Report Suggestions and Book References.

Electronic Sequencer

Order Code - 38686



The Electronic Sequencer is intended for elementary as well as advance training of digital electronics. The trainer cover regular digital circuits by solder less inter connections through use of 4 mm brass terminations and patch cords. logic level input / output indicators and DC regulated power supply are in built. The unit housed in finished box .

The Trainer Cover The Following Experiment :

Experiment 1 : Study Of Basic Gates And Verification Of Their Truth Tables.

- 1.1 NOT
- 1.2 OR
- 1.3 AND

Experiment 2 : Study And Verifications Of The Law Of Boolean Algebra And De-morgan's Theorems.

- 2.1.1 AND
- 2.1.2 OR
- 2.1.3 COMPLEMENT OR NOT

Theorems

- 2.2.1 $(A = A + 0)$
- 2.2.2 $(1 = A + 1)$
- 2.2.3 $(A = A + A)$
- 2.2.4 $(1 = A + A')$
- 2.2.5 $(A.1 = A)$
- 2.2.6 $(A.0 = 0)$
- 2.2.7 $(A.A = A)$
- 2.2.8 $(A.A' = 0)$
- 2.2.9 $(a \& b)$ De Morgan's Theorem-I LHS

- & RHS $(A + B)' = A'. B'$
- 2.2.10 $(a \& b)$ De Morgan's Theorem -II
LHS & RHS $(A . B)' = A' + B'$
- 2.2.11 $A + AB = A$
- 2.2.12 $A + A'B = A + B$
- 2.2.13 $(AB + AB') = A$
- 2.2.14 $(a \& b)(AB + A'C) = (A + C) (A' + B)$
- 2.2.15 $AB + A'C + BC = AB + A'C$
- 2.2.16 $A(A + B) = A$
- 2.2.17 $(a \& b)A(A' + B) = AB$
- 2.2.18 $(A + B) (A + B') + A$
- 2.2.19 $(A + B) (A' + C) = AC + A'B$
- 2.2.20 $(a \& b)(A + B) (A' + C) (B + C) = (A + B) (A' + C)$

Experiment 3 : Study Of Shift Register (sipo)

Feature:

- * Two Input AND Gate-Four Numbers Using 7408
- * Two Input OR Gate-Four Numbers Using 7432
- * NOT Gate-Six Numbers Using 7404
- * Memories Modules Eight Nos Using 7474
- * DC Power Supply : 5 V / 500 mA (Internally Connected)
- * Debounce Logic Switch : Six independent logic level inputs to select High / Low TTL levels,
- * Output LED Indicators : Eight independent logic level indicators for High / Low status indication of digital outputs.
- * Power ON : Power ON switch with indicator for mains on indication and fuse for protection.
- * Patch Cords : Set of 20 assorted coloured multi-stand wires with 4mm stackable plug termination at both ends.(Stackable)
- * Power Requirement : 230V + 10% single phase AC.
- * Instruction manual : One detailed instruction manual with well thought out experiments covering the above topics.

Electronic Simulator

Order Code - 38687



The Electronic Sequencer is intended for elementary as well as advance training of digital electronics. The trainer cover regular digital circuits by solder less inter connections through use of 4 mm brass terminations and patch cords. logic level input / output indicators and DC regulated power supply are in built. The unit housed in finished box .

The Trainer Cover The Following Experiment :

Experiment 1 : Study Of Basic Gates And Verification Of Their Truth Tables.

- 1.1 NOT
- 1.2 OR
- 1.3 AND
- 1.4 NOR
- 1.5 NAND

Experiment 2 : Study and Verifications Of The Law Of Boolean Algebra And De-morgan's Theorems.

- 2.1.1 AND
- 2.1.2 OR
- 2.1.3 COMPLEMENT OR NOT

THEOREMS

- 2.2.1 $(A = A + 0)$

- 2.2.2 $(1 = A + 1)$
- 2.2.3 $(A = A + A)$
- 2.2.4 $(1 = A + A')$
- 2.2.5 $(A.1 = A)$
- 2.2.6 $(A.0 = 0)$
- 2.2.7 $(A.A = A)$
- 2.2.8 $(A.A' = 0)$
- 2.2.9 (a & b) De Morgan's Theorem-I LHS & RHS $(A + B)' = A'. B'$
- 2.2.10 (a & b) De Morgan's Theorem -II LHS & RHS $(A . B)' = A' + B'$
- 2.2.11 $A + AB = A$
- 2.2.12 $A + A'B = A + B$
- 2.2.13 $(AB + AB') = A$
- 2.2.14 (a & b) $(AB + A'C) = (A + C) (A' + B)$
- 2.2.15 $AB + A'C + BC = AB + A'C$
- 2.2.16 $A(A + B) = A$
- 2.2.17 (a & b) $A(A' + B) = AB$
- 2.2.18 $(A + B) (A + B') + A$
- 2.2.19 $(A + B) (A' + C) = AC + A'B$
- 2.2.20 (a & b) $(A + B) (A' + C) (B + C) = (A + B) (A' + C)$

Experiment3: Construction And Verification Of Various Types Of Flip-flops Using Gates And Ic's

- 3.1.1 RS Flip - Flop using NAND Gates
- 3.1.2 RS Flip - Flop using NOR gates
- 3.1.3 Clocked R - S Flip - Flop
- 3.2.1 J - K Flip - Flop
- 3.2.2 J - K Flip - Flop with Clocks
- 3.2.3 Master - Slave J - K Flip - Flop
- 3.3 D Flip - Flop

Experiment 4 : Construction And Verification Of Various Types Of Combinational Circuits

- 4.1.2 to 1 Line Multiplexer (Encoder)
- 4.2.2 to 4 Line Demultiplexer (Decoder)
- 4.3.2 Bit Comparator

Experiment 5 : Construction And Verification Of Various Types Of Counters.

- 5.1 3 Bit Down counter
- 5.2 UPCounter
- 5.2. 1 3 Bit Synchronous Ripple UP Counter
- 5.2.2.3 Bit Asynchronous Ripple UP Counter
- 5.3 Ring Counter
- 5.4 Decade Counter

Feature:

- 01. NOT Gate-Six Numbers Using 7404
- 02. Two Input OR Gate-Four Numbers Using-7432
- 03. Two Input AND Gate-Four Numbers Using-7408
- 04. Two Input NAND Gate-Four Numbers Using-7400
- 05. Three Input NAND Gate-Four Numbers Using-7410
- 06. Two Input NOR Gate-Four Numbers Using-4001
- 07. Three Input NOR Gate-Four Numbers Using-7427
- 08. D FLIP-FLOP Eight Numbers Using 7474
- 09. JK FLIP-FLOP Eight Numbers Using 7476
- 10. RS FLIP-FLOP Eight Numbers Using 7400
- 11. DC Power Supply : 5 V / 500 mA (Int)
- * Debounce Logic Switch : Five independent logic level inputs to select High / Low TTL levels,
- * Output LED Indicators : Ten independent logic level indicators for High / Low status indication of digital outputs.
- * Two Way Debounce : Five independent logic level inputs to select levels For +5V & -5V Logic Switch
- * Variable Frequency/Clock : 0 To 2 KHz With digital display
- * Power ON : Power ON switch with indicator for

mains on indication and fuse for protection.

- * Patch Cords : Set of 20 assorted coloured multistand wires with 4mm stackable plug termination at both ends.(Stackable)
- * Power Requirement : 230V + 10% single phase AC.
- * Instruction manual : One detailed instruction manual with well thought out experiments covering the above topics.

Advance Level Logic Trainer

Order Code - 38688



Advance Level Logic Trainer has been designed specifically for the study of Re-triggerble monostable Synchronous counting, Up and down counting, Serial to Parallel data converting. Writing and reading data from Random Access Memory (RAM) and concepts of input output bus.

Practical experience on this board carries great educative value for Science and Engineering Students.

Object:

To design, fabricate and test the following:

- 01. To study Re-triggerble Monostable Multivibrator using IC 555 and output through LED.
- 02. Synchronous Counters:
 - 4-Stage binary synchronous up-counter with parallel carry.
 - 4-Stage binary synchronous down-counter with parallel carry.
 - 4-Stage binary synchronous up-counter with series carry.
 - 4-Stage binary synchronous down-counter with series carry.
 - 4-Stage binary synchronous up-down counter with Parallel carry.
 - 4-Stage synchronous up-down counter with series carry.
 - 4-Stage synchronous decade counter with parallel carry.
- 03. Series Parallel Counters:
 - 3-Stage mod-5 series parallel counter.
 - 4-Stage mod-10 series parallel counter.
- 04. Serial to Parallel Data Converter
- 05. 1024 X 4 Bit Static Random Access Memory (2114)
 - To study the Write operation of 1024 X 4 Bit Random Access Memory.
 - To study the Read operation of 1024 X 4 Bit Random Access Memory.
- 06. 8212 - Single Input/ Output Port
 - To Study Input and output modes of IC 8212 I/O Port.

Features:

The board consists of the following built-in parts:

- 01. + 5V D.C. at 200mA, IC Regulated Power Supply Internally connected.
- 02. +10V D.C. at 100mA, IC Regulated Power Supply internally connected.
- 03. 1 KHz Square Wave Generator.
- 04. Switches to set Data & Address.
- 05. LEDs for visual indication of Address used Data conditions.

06. Four, J-K master slave flip-flops with preset and clear arrangement.
07. Five, 2-input NAND gates.
08. Four, 4-input NAND gates.
09. Pulser switch for clear arrangement.
10. LEDs for visual indication of output status of each flip-flop.
11. Single I/O port IC 8212.
12. Tristate buffer IC 74244.
13. Transistor BC 177.
14. SPDT switches for logic selection.
15. Adequate no. of other Electronic Components.
16. Mains ON/OFF switch, Fuse and Jewel light.
- * The unit is operative on 230V $\pm 10\%$ at 50Hz AC. Mains.
- * Adequate no. of patch cords stackable from rear both ends 2mm spring loaded plug length $\frac{1}{2}$ metre.
- * Good Quality, reliable terminal/sockets are provided at appropriate places on panel for connections / observation of waveforms.
- * Strongly supported by detailed Operating Instructions, giving details of Object, Theory, Design procedures, Report Suggestions and Book References.

Other Apparatus Required

01. Dual Trace Cathode Ray Oscilloscope 20 MHz (Optional).

Analog Computer Trainer

Order Code - 38689



Order Code 38689 The Analog Computer Trainer is a totally solid state electronic device designed to teach the basics of analog computation and to solved various differential equations to engineering & science students. Using this trainer board, students can study the various building blocks used in the analog computation like summing amplifiers, integrating amplifiers, inverting amplifiers & coefficient multipliers. Using this trainer board the students can solve linear equations, simultaneous equations & differential equations with constant coefficients.

Objects:

1. To study building blocks.
 - To study summing amplifier (Adder)
 - To study the inverting amplifier
 - To study difference amplifier (Sub tractor)
 - To study summing & difference amplifier (Adder & Sub tractor)
 - To study integrating amplifier.
 - To study summing integrating amplifier
2. To study analog computer
 - To solve linear equations
 - To solve simultaneous linear equations
 - To solve linear differential equations
 - To solve simultaneous differential equations with constant coefficient.

Features:

01. FET input Op-Amp. are used.
02. In built power supply

03. Detachable patch board is provided therefore computer may be programmed to solve many kinds of problems.
04. Variable reference voltage controlled by helical potentiometer.
05. Digital voltmeter is provided to set coefficient multiplier and to measure output voltage.
06. Time scaling switch to vary the time constant of integrator
07. Mode selection switch to select mode of operation
08. Facility to set initial condition to any desire value.
- * Weight : 9 Kg. (Approx.)
- * Dimension : W 445 x H 260 x D 470

Technical Specifications:

01. No. of summing amplifier : 5
02. No. of Inverting amplifier : 5
03. No. of coefficient multipliers : 10
04. No. of Integrating amplifier : 5
05. Output voltage swing : $\pm 12V$
06. Input impedance of each amplifier : 1M
07. Power supply : 3 nos.
08. Modes of operation : hold, compute, reset, graph plot & repetitive

Other Apparatus Required:

- * Cathode Ray Oscilloscope (Necessary only in REPETITIVE mode)

Electronic Sequencer

Order Code - 38690



The Electronic Sequencer is intended for elementary as well as advance training of digital electronics. The trainer cover regular digital circuits by solder less inter connections through use of 4 mm brass terminations and patch cords. logic level input / output indicators and DC regulated power supply are in built. The unit housed in finished box .

Experiments:

Experiment 1 : Study Of Basic Gates And Verification Of Their Truth Tables.

- 1.1 NOT
- 1.2 OR
- 1.3 AND

Experiment 2 : Study And Verifications Of The Law Of Boolean Algebra And De-morgan's Theorems.

- 2.1.1 AND
- 2.1.2 OR
- 2.1.3 COMPLEMENT OR NOT

Theorems

- 2.2.1 $(A = A + 0)$
- 2.2.2 $(1 = A + 1)$
- 2.2.3 $(A = A + A)$
- 2.2.4 $(1 = A + A')$
- 2.2.5 $(A.1 = A)$
- 2.2.6 $(A.0 = 0)$
- 2.2.7 $(A.A = A)$
- 2.2.8 $(A.A' = 0)$
- 2.2.9 (a & b) De Morgan's Theorem-I LHS & RHS $(A + B)' = A'. B'$
- 2.2.10 (a & b) De Morgan's Theorem -II LHS

- 2.2.11 $A + AB = A$
- 2.2.12 $A + A'B = A + B$
- 2.2.13 $(AB + AB') = A$
- 2.2.14 $(a \& b)(AB + A'C) = (A + C)(A' + B)$
- 2.2.15 $AB + A'C + BC = AB + A'C$
- 2.2.16 $A(A + B) = A$
- 2.2.17 $(a \& b)A(A' + B) = AB$
- 2.2.18 $(A + B)(A + B') + A$
- 2.2.19 $(A + B)(A' + C) = AC + A'B$
- 2.2.20 $(a \& b)(A + B)(A' + C)(B + C) = (A + B)(A' + C)$

Experiment 3 : Study Of Shift Register (sipo)

Feature:

- Two Input AND Gate : 4 Nos Using 7408
- Two Input OR Gate : 4 Nos Using 7432
- NOT Gate : 6 Nos Using 7404
- Memories Modules : 8 Nos Using 7474
- Relays : 8 Relays with one Input terminal and three output contact terminals
- Timers : 2 Timer section having variable potentiometer to cover 5 sec to 1 min range
- DC Power Supply : Internally Connected
- Debounce Logic Switch : 6 independent logic level inputs to select High / Low TTL levels
- Output LED Indicators : 8 independent logic level indicators for High / Low status indication of digital outputs
- Power ON : Power ON switch with indicator for mains on indication and fuse for protection.
- Patch Cords : 40 Safety Leads 4 mm (Different Colours & length)
- Power Requirement : 230V + 10% single phase AC.
- Instruction manual : One detailed instruction manual with well thought out experiments covering the above topics.

Logic Gate Tutor

Order Code - 38691



Order Code-38691 The Logic Gates Tutor is intended for elementary as well as advance training of digital electronics. The trainer Cover regular digital circuits by solder less inter connections through use of 2 mm brass terminations and patch cords. Various clock generators, logic level input /output indicators and DC regulated power supply are in built.

Experiments:

Experiment 1: Study of basic gates and verification of their truth tables:

- 1.1 NOT
- 1.2 OR

- 1.3 AND
- 1.4 NOR
- 1.5 NAND
- 1.6 EX-OR
- 1.7 EX -NOR

Experiment 2: Study and verifications of the law of Boolean algebra and De-Morgan's Theorems.

- 2.1.1 AND
- 2.1.2 OR
- 2.1.3 COMPLEMENT OR NOT

THEOREMS

- 2.2.1 $(A = A + 0)$
- 2.2.2 $(1 = A + 1)$
- 2.2.3 $(A = A + A)$
- 2.2.4 $(1 = A + A')$
- 2.2.5 $(A.1 = A)$
- 2.2.6 $(A.0 = 0)$
- 2.2.7 $(A.A = A)$
- 2.2.8 $(A.A' = 0)$
- 2.2.9 (a & b) De Morgan's Theorem-ILHS & RHS $(A + B)' = A' . B'$
- 2.2.10 (a & b) De Morgan's Theorem -II LHS & RHS $(A . B)' = A' + B'$
- 2.2.11 $A + AB = A$
- 2.2.12 $A + A'B = A + B$
- 2.2.13 $(AB + AB') = A$
- 2.2.14 $(a \& b)(AB + A'C) = (A + C)(A' + B)$
- 2.2.15 $AB + A'C + BC = AB + A'C$
- 2.2.16 $A(A + B) = A$
- 2.2.17 $(a \& b)A(A' + B) = AB$
- 2.2.18 $(A + B)(A + B') + A$
- 2.2.19 $(A + B)(A' + C) = AC + A'B$
- 2.2.20 $(a \& b)(A + B)(A' + C)(B + C) = (A + B)(A' + C)$

Experiment 3: Study of important TTL terminologies.

Verification of important TTL Circuit parameters

- 3.1.1 Low State Input Current IIL
- 3.1.2 High State Input Current IIH
- 3.1.3 Low State Output Voltage VOL
- 3.1.4 High State Output Voltage VOH
- 3.2 TTL Transfer Characteristics

Experiment 4: Construction and verification of various types of combinational circuits:

- 4.1 Half Adder
- 4.2 Full Adder
- 4.3 Half Subtractor
- 4.4 Full subtractor
- 4.5 Even / Odd parity checker
- 4.6 2 to 1 Line Multiplexer (Encoder)
- 4.7 2 to 4 Demultiplexer (Decoder)
- 4.8 Binary to Gray Converter
- 4.9 Gray to Binary Converter
- 4.10 2 Bit comparator

Feature:

- 01. DC Power Supply : ± 5 V at 500 mA (IC based regulated output)
- 02. Logic Level Inputs : Eight independent logic level inputs to select High / Low TTL levels
- 03. Logic Level Indicators : Eight independent logic level indicators for High / Low status
- 04. Logic Gate with Mimic Diagram : 30 No.
 - 4.1. 2-input NAND gates : 8 No.
 - 4.2. Inverters (NOT gates) : 6 No.
 - 4.3. 2-input NOR gates : 4 No.
 - 4.4. 2-input AND gates : 4 No.
 - 4.5. 2-input EX-OR gates : 4 No.
 - 4.6. 2-input OR gates : 4 No.
- 05. Power ON : Power ON Switch with indicator for

mains on indication and fuse for protection

- 06 Patch Cords : Patch cords stackable 2mm plug both side Red & Black
- 07. Power Requirement : 230V \pm 10% single phase AC
- 08. Instruction manual : One detailed instruction manual with well thought out experiments covering the above topics



Understanding and Experiment with Digital Ics

Order Code - 38695



38695 Understanding and Experimentation with Digital ICs is a training product which provides complete flexibility for hands on learning of a wide range of experiments in digital electronics. This product provides vast learning scope for students to design their own experiment and applications. Students can use digital IC's and connect their Input & Output to design & implement in the circuit. 38695 can be a part of library & can be issued to students to perform the experiments.

Objects:

- 01. Study of Adder and subtractor.
- 02. Study of Multiplexer and De-Multiplexer.
- 03. Study of BCD to 7 Segment Display.
- 04. Study of Encoder, Decoder and Generator.
- 05. Study of Code Converter.
- 06. Study of Magnitude Comparator.
- 07. Study of Flip-Flop.
- 08. Study of Register.
- 09. Study of Counter.

Feature:

- 01. Illustration of Combinational and Sequential circuits
- 02. ZIF Socket provided for easy connections
- 03. Compact size
- 04. Simultaneous use of multiple Ics

Technical Specification:

- 01. Mains Supply : 230 V \pm 10%, 50 Hz
- 02. Fixed DC Power Supply : +12 V, -12V, +5 V, -5V AT 100mA
- 03. Clock Generator : 1Hz, 10 Hz, 100 Hz, 1 KHz, 10 KHz and 100 Hz
- 04. Pulse Generator : 5V
- 05. ZIF Socket : 20 Pins (6Nos.), 40 Pins (1 Nos.)
- 06. 8 Bit Digital Input : 08 toggle switches
- 07. 12 Bit Digital Output : 12 LED indicator
- 08. BCD to seven segment display 2 nos.
- 09 Dimension (mm) : W 415 x H 165 x D 315

List of Accessories:

- 01 Patch cord 2mm length 50cm Red -----20Nos.
- 01 Patch cord 2mm length 50cm Black -----20Nos.

TTL and CMOS Characteristic Trainer

Order Code - 38696

38696 "TTL & CMOS"Characteristics Trainer" is a simple and compact product designed to explain all the fundamentals of Transistor-Transistor Logic (i.e. TTL) and Complementary Metal Oxide Semiconductor (i.e. CMOS), like voltage Transfer Characteristics, Noise Margin and Gate Delay. Inbuilt Function Generator and DC supply is provided for ease of operation. The voltage Transfer Characteristics of a logic gate is a graph between gate output voltage and gate input voltage. Noise Margin is the voltage difference by which the signal exceeds the threshold voltage for Logic high. Gate delay is the span of time starting from the instant when the input to a logic gate becomes stable, to the time that the output of that logic gate becomes stable.

Objects:

To study voltage transfer characteristics, noise margin and gate propagation delay of :

- 01. TTL NAND Gate.
- 02. TTL Schmitt trigger NAND gate.
- 03. TTL NOT gate.
- 04. TL Schmitt trigger NOT gate.
- 05. CMOS NAND gate.
- 06. CMOS Schmitt trigger NAND gate.
- 07. CMOS NOT gate.
- 08. CMOS Schmitt trigger NOT gate.

Features:

- 01. In built DC Power supply.
- 02. In built Function generator.
- 03. Compact Design.

Technical Specification:

- 01. DC Power supply : +5V, +12V
- 02. Variable DC Power supply : 0 to5V & 12V

Pulse Generator:

- 01. Frequency : 100Hz.
- 02. Amplitude : 0 to 5Vpp
- 03. Mains supply : 230V \pm 10%, 50Hz
- 04. Weight : 1Kg (Approximately)
- 05. Dimension (mm) : W340 X H125 Xd210

List of Accessories:

- 01. Patch cord 2mm length 50cm Red-----04
- 02. Patch cord 2mm length 50cm Black----- 04

Other Apparatus Required:

- 01. Digital Storage Oscilloscope.

Parallel Adder and Subtractor Trainer

Order Code - 38697



38697 Parallel Adder and Subtract or Trainer is a ready to use digital electronics experiment trainer. This product, has been designed specifically for the students

to understand the concept of parallel binary addition and subtraction methods for-4- bit and 8 bit binary numbers.

A Parallel Adder is a combinational logic circuit which has various registers to input the data and thus generate the output. Because of this, input bits are applied simultaneously and the sum appears at the output almost immediately. The parallel subtractor circuit works in similar manner where the difference appears as soon as the inputs are applied.

This product has logic switches with LEDs for logic high and low input facility.

Object:

- 01. To study 4 bit binary addition & subtraction operation
- 02. To study 8 bit binary addition & subtraction operation

Features:

- 01. 4-bit/8-bit Binary Addition & Subtraction
- 02. Easy switching between addition and subtraction modes
- 03. LEDs fo6/visual indication of input-output & carry out logics

Technical Specification:

- 01. DC Power Supply : +5 V DC
- 02. Logic levels
+5V : High (logic 1)
0V : Low (logic 0)
- 03. LED indication : LED will be ON for logic high or '1' state and Will be OFF for Logic low or '0' state
- 04. Weight : 1 KG (Approx)
- 05. Dimensions (mm) : W340 X H125 X D210

List of Accessories:

- 01 Patch Cord 2mm length 50 cm Red-----14
- 02 Patch Cord 2mm length 50cm Black-----13

BCD Trainer and Subtractor Trainer

Order Code - 38698



38698 BCD Adder and Subtract or Trainer is a compact, ready to use digital electronics experiment board. This product has been designed specifically for the students to study and understand the concept of BCD addition and subtraction processes.

38698 has logic high-low input switch facility, LEDs for visual indication and direct reading of the inputOutput logic states and carry status.

Object:

- 01. Study of 1bit to 8Bit BCD Addition operation.
- 02. Study of 1bit to 8bit BCD Subtraction operation.

Features:

- 01. Facilitates 1 bit to 8bit BCD addition and subtraction modes.
- 02. LED's for visual indication of input output logic states.
- 03. Easy switching between addition and subtraction modes.

- 04. Unique design.

Technical Specification:

- 01. DC Power Supply : +5V
- 02. Logic Levels (Input Section A & B Total 16)
+5V.....: High (Logic 1)
0V.....: Low (Logic 0)
- 03. LED Indication : 26 Nos.
Output section 10 & Input Section 16 Nos.
LED will be ON for logic High or '1' State and will be OFF for logic low or '0' state.
- 04. Control Switch for Subtraction / Addition.
- 05. Operating Conditions : 0-40 oC, 85% RH
- 06. Power Supply : 230V ±10%, 50Hz
- 07. Power Consumption : 2VA (approximately)
- 08. Weight : 2.300 Kg (Approx)
- 09. Dimension : W340 X H125 X D210

Other Apparatus Required:

- 01. Digital storage Oscilloscope

SOP and POS Implementation Trainer

Order Code - 38699



38699 SOP & POS implementation Trainer is compact, ready to use digital electronics experiment board. It is useful for students to get a practical insight into the implementation of different canonical forms. The various applications of a canonical forms are representing any boolean function as a product of sum or sum of product.

Trainer Has built in clock source, logic high low input facility and LED`s for visual indication of input output states.

Object:

- 01. Design a function sing K-map and verify its performance using SOP and POS FORM.
- 02. Use QUINE McClUSKEY method for designing function and realize its Nor Or implementation.

Features:

- 01. Stand alone System
- 02. Easy illustration of different types of canonical forms.
- 03. LEDs for visual indication of input and output logic states.
- 04. SPDT switches for input lgic selection.

Technical Specification:

- 01. DC Power Supply : +5 V DC
- 02. Logic levels
+5V : High (logic 1)
0V : Low (logic 0)
- 03. LED indication : LED will be ON for logic high or '1' state and Will be OFF for Logic low or '0' state
- 04. Weight : 1 KG (Approx)
- 05. Dimensions (mm) : W340 X H125 X D210

List of Accessories:

- 01. Patch Cord 2mm length 50 cm Red-----05

02. Patch Cord 2mm length 50cm Black-----05

Multiplexer - Demultiplexer 8:1 and 1:8

Order Code - 38700



38700 Multiplexer and Demultiplexer Trainer has been designed specifically for the study of 8-to-1 Line Multiplexer and 1-to-8 Line Demultiplexer. This Training Board familiarizes the students with the operation of both multiplexer and demultiplexer circuit. It explains the phenomena of Multiplexing of four input signals with two selection lines and one output. It explains Demultiplexing of one input signal with two selection lines and four outputs.

The board is absolutely self contained and requires no other apparatus.

Object:

- 01. Study and verification of the Truth Table of 8-to-1 Line Multiplexer.
- 02. Study and verification of the Truth Table of 1-to-8 Line De-Multiplexer.

Technical Specification:

The board consist of following built in parts.

- 01. + 5V D.C. at 100mA , IC regulated power supply internally connected.
- 02. Multiplexer IC 74151.
- 03. De-multiplexer IC 74138.
- 04. Eight LEDs for visual indication of status.
- 05. Eleven SPDT switches for logic selection low and High.
- 06. Adequate no. of Electronic Components.
- 07. Mains ON/OFF switch, Fuse and Jewel light.
- 08. The unit is operative on 230V ±10% at 50Hz A.C. Mains.
- 09. Good Quality, reliable terminal/sockets are provided at appropriate places on panel for connections /observation of waveforms.
- 10. Strongly supported by detailed Operating Instructions, giving details of Object, Theory, Design procedures, Report Suggestions and Book References.
- 11. Weight : 2Kg. (Approx).
- 12. Dimension : W 415 x H 165 x D 315

List of Accessories:

- 01 Patch cord 2mm length 50cm Red----- 06
- 02 Patch cord 2mm length 50cm Black-----06

To Verify the truth table of basic logic gates or AND NOR, NAND, Ex-OR, Ex-NOR and NOT (using 2,3,4 Input and Gates)

Order Code - 38701



38701 Logic Training Board has been designed for the

Study of the Truth Table of Basic Gates OR, AND, NOR, NAND, EX-OR, EX-NOR and NOT using (2, 3, 4 input) and one output.

Practical experience on this board carries a great education value for science, computer and Engineering students.

Objects:

- 01. To verify the Truth Table of with Two input.
 - 1.1 OR
 - 1.2 AND
 - 1.3 NOR
 - 1.4 NAND
 - 1.5 EX-OR
 - 1.6 EX-NOR
 - 1.7 NOT
- 02. To verify the Truth Table of Basic Logics Gates with Three input.
 - 2.1 OR
 - 2.2 AND
 - 2.3 NOR
 - 2.4 NAND
 - 2.5 EX-OR
 - 2.6 EX-NOR
- 03. To verify the Truth Table of Basic Logics Gates with Four input.
 - 3.1 OR
 - 3.2 AND
 - 3.3 NOR
 - 3.4 NAND
 - 3.5 EX-OR
 - 3.6 EX-NOR

Technical Specification:

The Training Board consists of the following in parts:

- 01. +5V DC at 100mA IC Regulated power supply Internally connected.
- 02. IC for Different Gates (OR, AND, NOR, NAND EX-OR, EX-NOR, NOT)
- 03. 4 SPDT, Data, Switch for logic input.
- 04. One LO? for output Logic indication.
- 05. Adequate No. of other electronic components .
- 06. Mains On/Off switch, fuse & Jewel light.
- 07. This unit is operative on 230V ± 10% at 50Hz A.C. Mains.
- 08. Adequate no. of patch cords stackable 2mm spring loaded plug length 50cm.
- 09. Good Quality, reliable terminal/sockets are provided at appropriate places on panel for connections / observation of waveforms.
- 10. Strongly supported by detailed Operating Instructions, giving details of Object, Theory, Design procedures, Report Suggestions and Book References.
- 11. Weight : 1Kg. Approx.
- 12. Dimension : W340 X H125 X D210

List of Accessories:

- 01. Patch cord 2mm length 50cm Red----- 03
- 02. Patch cord 2mm length 50cm Black-----03

Multiplexer-Demultiplexer 4:1 and 1:4

Order Code - 38702



38702 Multiplexer and demultiplexer Trainer has been designed specifically for study of 4-to 1 line multiplexer and 1 to 4 line demultiplexer. This Training board familiarizes the operation of both multiplexer and demultiplexer circuit. It explains the phenomena of multiplexing of four input signals with two selection lines one output, It explains Demultiplexing of one input signal with two selection lines four outputs. The board is absolutely self contained and requires no other apparatus.

Technical Specification:

The board consist of following built in parts.

01. +5V DC at 100mA IC regulated power supply internally connected.
02. Multiplexer IC 74153.
03. De- multiplexer IC 74139.
04. Five LED`s for visual indication of status.
05. Six SPDT switches for logics selection low and high.
06. Adequate no. Of Electronic components.
07. Mains ON/OFF switch, Fuse and jewel light.
08. The unit is operative on 230V + 10% at 50Hz AC mains.
09. Good quality reliable terminal/sockets are provided at appropriate places on panel for connections of waveform.
10. Strongly supported by detailed operating instructions, giving details of object, Theory design procedures, report suggestions and book references.
11. Weight : 1Kg (Approx)
12. Dimension : W340 x H125 x D210

List of Accessories:

01. Patch code 2mm length 50cm Red-----04
02. Patch code 2mm length 50cm Black----- 04

Electrical Specimen Board

Order Code - 38001



Electrical specimen board have been designed specifically to study different types of insulators, isolators conduit pipes, plugs and receptacles. With help of this trainer student can make easy understanding about electrical isolators & insulators.

Isolators:

- 2 pole 40A - 01
- 3 Pole 40A - 01
- 4 Pole 40A - 01

Insulators:

Low voltage electrical C25 m6 conical busbar insulator for 1500V-01 set.

Plug (Stepless):

2Pin 5A, 3Pin 6A, 3Pin (-) 10A, 3Pin 16A, 2Pin 20A Industrial.

Receptacles:

2Pin 5A, 3Pin 16A, 3Pin 10A, 5Pin 6A, 2Pin 20A with cap.

PVC conduit pipe: Size - ½ & 1 inch

Liquid flexible non metallic conduct pipe:

Size - ½ & 1 inch

PVC cusing & capping:

Size - 1 & 1½ inch

Dimension:

600 x 455mm, using aluminum steel, for batter safety, rigidness and contrast. Fixed on iron box with black powder coated.

Wiring Specimen Board

Order Code - 38002

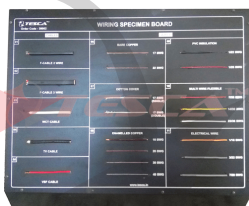

Wiring specimen board have been designed specifically to study different types of cables & wires. With help of this trainer student can make easy understanding with different kind of wires & cables. It consists following: -

Cable:

- 01. F-cable 2 wire
- 02. F-cable 3 wire
- 03. WCT cable
- 04. TV cable
- 05. VSF cable

Wires:

- 01. Bare copper - 17, 22, SWG

- 02. Cotton Cover - 17, SWG single, 17, SWG Double
- 03. Enameled Copper - 10, 20, 30, 40, SWG
- 04. PVC insulation - 1/22, 1/25, SWG
- 05. Multiwire flexible - 7/36, 14/36, 23/36, SWG
- 06. Electrical wire - 1/18, 3/22, 7/20, SWG

Dimension:

600 x 455mm, using aluminum steel, for batter safety, rigidness and contrast. Fixed on iron box with black powder coated.

Electronic Components Display Boards

Order Code - 38003 - 38016A

Order Code-38003 to 38016 Series Electronic Component Display Boards have been designed specifically to study different types of Resistors, Potentiometers, Capacitors, Switches, Band switches, Diodes, Transistors, Semi-conductor devices, Cables, Connectors, Relays, Transformers and Different IC's. Practical experience on this board carries great educative value for Science and Engineering Students. Order Code-38003 to 38016 Series consists of the following :

Features:

- 01. Board Size 300 X 400mm, with better safety, rigidness and contrast.
- 02. Symbolic representation of Components.
- 03. Actual components mounted right across the place.
- 04. Individual working without direct teacher supervision.
- 05. Stimulates independent student activity.

Study of Different Resistors & Colour Coding

Order Code-38003



Carbon Resistors 1/4, 1/2, 1 & 2 Watt of different tolerances, Metal Film Resistors 1/4, Watt, High Precision, Wire Wound Resistors of different types with complete theory description. Total 20 Resistors.

Study of Different Potentiometers

Order Code-38004



Carbon Resistors 1/4, 1/2, 1 & 2 Watt of different tolerances, Metal Film Resistors 1/4, Watt, High Precision, Wire Wound Resistors of different types with complete theory description. Total 20 Resistors.

Study of Different Capacitors & Colour Coding
Order Code - 38005



Ceramic disc, Mica button, Tantalum radial, Tantalum axial, Non-electrolytic disc, Electrolytic Radial, Polyester foil, Styroflex, Ceramic Tabular paper, Metalised Polyester, Metalised Poly-Carbonate, Metalised Poly-propylene, Metalised film, Trimmer and Gang Condenser with theory and description. Total 16 Capacitors.

Study of Different Switches
Order Code - 38006



PUSH to 'ON', PUSH to 'OFF', Slide, Key Board, DIP Switch, Leaf Switch, SPST Toggle, Miniature DPDT Toggle, Rocker and Rotary Thumb wheel with complete theory and description. Total 13 Switches.

Study of Different Band Switches
Order Code - 38007



1 Pole 11 Way, 2 Pole 5 Way, 4 Pole 3 Way for Radio etc. 1 Pole 11 Way Miniature and 2 Pole 5 Way Miniature, 6 Pole 3 Way for Transistors Mega type Band switches with complete Theory and description. Total 7 Band Switches.

Study of Different Diodes
Order Code - 38008

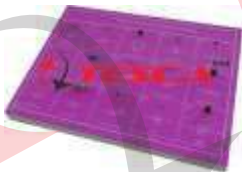

Silicon detector, Silicon rectifier, Bridge rectifier, Germanium diode, Hot Carrier diode, Power diode, Varactor diode, Photo diode, Trigger Diode and Zener diode with complete theory and description. Total 10 diodes

Study of Different Transistors
Order Code - 38009



A small signal, IF/RF Amplifier, High speed switching Power, General purpose, All above are PNP & NPN both type, Matched pair, Darlington Pair, High Voltage, Photo transistor, UJT, FET and MOSFET. Total 19 transistors.

Study of Semiconductor Devices and How to Test Them
Order Code - 38010



Silicon Diode, Germanium Diode, Zener Diode, Varactor Diode, Varistor, Thermistor, U.J.T., Transistor NPN & PNP, Power Transistor NPN & PNP, JFET, MOSFET, SCR, TRIAC, LED, Photo Diode, LDR, Photo Transistor and Opto Coupler with Theory and testing procedure. Total 20 devices.

Study of Different Wires & Cable
Order Code - 38011



Study of Bare Copper, Cotton Cover, Enamelled Copper, PVC Insulation, Multiwire Flexible, Electrical Wire and Flat Cable, Transmission Cable, Wave Guide Rectangular and Single Fibre Cable.

Study of Different Connectors
Order Code - 38012



To study Eyelet, Test pin, Insulated post, IC bases, Relay socket, Vacuum tube socket solder type, PCB terminal, One peice edge connector, Two peice connector, Rack and panel connector, Plug & receptacle connector, Cylindrical connector and Tape cable connector.

Display Board on Different Type Relay
Order Code - 38013



Plug in Relay 12 V 2C / O, 12 V 3C / O, 24 V 2C / O. 24 V 3C / O. General Purpose Relay 18 V 1C / O, 18 V 2C / O, 24 V 1C / O, 24 V 2C / O. General Purpose Relay 12 V 2C / O, 12 V 3C / O, PCB Mount Relay 6 V 1C / O, 18 V 1C / O, 24 V 1C / O, PCB Mount Relay 12 V 1C / O, Special Relay 18 V 2C / O, Reed Relay Dip 5 V 1N / O, 24 V 1N / O, 5 V 2N / O, Power Relay 24 V DC 1C / O

Display Board On Different Transformer
Order Code - 38014



Isolation Transformer, Pulse Transformer, Voltage Transformer. Current Transformer, Impedance Transformer, Auto Transformer, Power Transformer, Constant Voltage Transformer

Display Board on Different IC's
Order Code - 38015



IC CD 7680 VIF & SIF stage, TC TDA 2611A sound output stage. IC STMB 78237VM / 23A9950F System control, IC TA 7698 Chroma section. IC 8085A Microprocessor, IC 8155A Programmable I/O Ports & Timer. IC 8255A Programmable peripheral Interface, IC 8253 Programmable interval timer. IC 8259A Programmable interrupt controller, IC LM 380 Audio Amplifier, IC TBA 810 Audio Amplifier

Transformer Display Step Down Transformer
Order Code - 38016



Input 220VAC Output 6 - 0 - 6VAC at Lamp.

Step Down Transformer
Order Code - 38016A



Input 220VAC Output 24VAC Current 1Amp Size 200 x 300



TESCA™

8085 Microprocessor Trainer

Order Code - 43002

8085 Microprocessor Trainer can interface with IBM PC/XT/AT computer with the help of 96 bit TTL I/O Experimental Interface and Editor Assembler Software. It is quite an efficient system based on Industry Standard Intel 8085 ip for the purpose of training and prototype development of microprocessor based systems. Its hardware is capable of supporting multi processor configuration also.



The unit is self contained and requires no other apparatus. Practical experience on this board carries great educative value for Science and Engineering Students.

The Microprocessor trainer is designed to teach the subject of Microprocessor programming and interfacing through practical, essentially designed to teach the study of :

01. Design student projects.
02. Familiarize components used in Microprocessor based instruments.
03. Study the signals generated by the Microprocessor.
04. Learn the art of programming in machine language.
05. Design application oriented equipment.
06. Design and debugging techniques, etc.
07. Perform input / output experiments.
08. Instruction set of 8085.

Hardware Specifications:

- CPU** : 8085 Microprocessor @6.144 MHz
- MEMORY** : Total space ON BOARD is 48KB, Comprising of 16KB monitor EPROMS and 32KB RAM. Battery Backup for RAM. No expansion required.
- PERIPHERALS** : 8279 for controlling 24 feather keys (including 6 digit seven segment display).
 - : 1 Timer/counter with three independtly programmable counters.
 - : Two 8255 for controlling 48 I/O lines and same are brought out to FRC 50 pin connector.
 - : 8251 for RS 232 C serial communication and firmware for UP/DOWN facility for IBM PC/XT/AT computer.
 - : Built-in cassette interface.
 - : Built-in Speaker interface.
 - : Built-in EPROM programmer for 27128 operating at 12.5V.
- INTERFACING SIGNALS** : All buffered & demultiplexed TTL compatible signals brought on a 50 pin FRC connector including address and data control lines brought out at another 50 pin FRC connector. Several experimental interface modules can be connected to this trainer. They are ADC, DAC, Stepper motor, 8-bit

switch input, 8-bit LED output, Relay interface module, etc. and many more are available.

The following programs can be performed on the above 8085 Microprocessor Trainer, detail of which have been provided in the manual supplied with the Trainer.

Experiment:

01. Program to perform integer division 8-bit by 8-bit.
02. Program to perform integer division 16-bit by 8-bit.
03. Transfer of a block data in memory to another place in memory in the direct and reverse order.
04. Finding the parity of number.
05. Sorting of array in Ascending order.
06. Sorting of array in Descending order.
07. Program to multiply two 8-bit numbers.
08. Program to generate and sum 15 Fibonacci number.
09. Program for rolling display of message "INDIAN"
10. To insert a number at correct place in a sorted array.
11. Program to display smallest number in an array.
12. Program to display largest number in an array.
13. Program to add 2 numbers in Hex and Decimals
14. 4 digit Hex counter.
15. Program for converting 8 bit binary (Hex) to Decimal.
16. Subtraction of two 16 bit numbers.
17. Program to perform Hex to BCD conversion.
18. Program to read key board and display its code.
19. Program to find HCF.
20. Program to find LCM.

Software Capabilities:

The Monitor provided in 32K EPROM is capable of assisting the user, entering, editing and running the programs in assembly language. Along with other keys the following keys support these features .

- SETADDR** : This key allows to examine and optionally update the RAM.
- EXAM/ REG** : This key allows to examine and optionally update the CPU Registers.
- "GO" & "EXEC" KEYS** : These keys allow running of the user or monitor programs at full speed.
- STEP** : This key allows running of the user or monitor programs, one instruction at a time

Features:

01. The unit is operative on 230V, 50 Hz A.C. Mains.
02. Strongly Supported by Detailed operating Instructions, giving details of Object, Theory, Design procedures, Report Suggestions and Book References.
03. Power Supply: 5V @ 1A, ± 12V @ 500mA All assembled in an well de signed cabinet.

Accessories:

01. 50 pin FRC Cable 2 Nos.
02. Software CD 1 Nos.

8086 Microprocessor Trainer

Order Code - 43003



8086 Microprocessor Trainer uses Intel 8086 is a 16-bit microprocessor as CPU. This is one step above 8085 (8-bit) microprocessor. The term "16-bit" means that its arithmetic logic unit, internal registers, and most of its instructions are designed to work with 16-bit binary words. The 8086 has a 16-bit data bus, so it can read data from or write data to memory and ports either 16 bits or 8 bits at a time. As its address bus is 20-bit wide, it can address memory up to 1,048,576 locations. Each of the 1MB locations represents bit-wide. Therefore it is necessary to study by experimentation how a 8086 microprocessor responds for various conditions. Using this trainer, students studying in electronics, electrical, instrumentation, mechanical, chemical engineering subjects, B.Sc. (electronics, computers, and physics) laboratory, and polytechnics can learn programming an 8086 Microprocessor. This can be used to some extent for designing prototypes.

Specifications:

- CPU** : 8086 Microprocessor @ 6.144 MHz
- MEMORY** : Total space ON BOARD is 32KB, Comprising of 16KB monitor EPROMS and 16KB RAM. Battery backup for RAM.
- PERIPHERALS** : 8279 for controlling 24 feather keys (including 7 digit seven segment display).
: One 8255 for controlling 24 I/O lines and same are brought out to 50 pin FRC connector.

The following programs can be performed on the above 8086 microprocessor trainer, detail of which have been provided in the manual supplied with the trainer.

01. Program to perform 16-bit addition
02. Program to perform 16-bit subtraction.
03. Program to perform 16-bit multiplication.
04. Program to perform 16-bit division.
05. Program to display largest no. in an array.
06. Program to display smallest no. in an array.
07. Program to arrange numbers in ascending order.
08. Program to arrange numbers in descending order.
09. Program to determine factorial of a number.
10. Program to determine fibonacci series of a number.
11. Program to check password.
12. Program to perform scrolling display.

- POWER SUPPLY** : ±12V @ 500mA . All assembled in an well designed cabinet.
- ACCESSORIES** : 50 pin FRC Cable 1 No.

Software Capabilities:

The Monitor provided in 32K EPROM is capable of assisting the user, entering, editing and running the programs in assembly language.

Features:

01. The unit is operative on 230V, 50 Hz A.C. Mains.
02. Strongly Supported by Detailed operating

Instructions, giving details of Object, Theory, Design procedures, Report Suggestions and Book References.

8031 Micro-Controller Trainer

Order Code - 43004

8031 Micro Controller Trainer uses 8031/8051 versatile micro-controller. This controller finds extensive applications in automation. This is because of its architecture and built-in I/O capabilities. The use of this controller considerably reduces the chip count in the final product design.



Hence this finds extensive applications in automatic vending machines, weighing machines, welding machines, microwave ovens etc. Therefore it becomes necessary to study the function and its capabilities, by experimentation.

The Micro-controller trainer is an IBM PC/XT/AT & Pentium compatible instrument. This is a single PCB module. The instrument is connected to serial port of IBM computer at RS232C port. A 50 pin FRC connector provides unbuffered Address, Data and Control Lines. This may be used for system expansion at a later date.

Features:

01. Terminal emulation software is supplied along with the trainer. This supports UP LOAD and DOWN LOAD function.
02. In addition to this, it has features to modify and display internal as well as external memory locations.
03. Dump memory contents in some other location as specified.
04. Move a block of memory from a source address to destination address.
05. Execute from a specified memory location.
06. Display contents of all register and alter a few or all registers.
07. Facility to stop execution once a break point location reaches.
08. The unit is operative on 230V, 50 Hz A.C. Mains.
09. Strongly Supported by Detailed operating Instructions, giving details of Object, Theory, Design procedures, Report Suggestions and Book References.

Specifications:

- CPU** : 8031 Micro Controller 12MHz..
- MEMORY** : 32KB EPROM, 32 KB RAM and 2KB NV RAM. Battery Backup for RAM.
- PERIPHERALS** : 8279 for controlling 24 feather keys (including 6 digit seven segment display).
: 32 programmable I/O pins (24 from 8255 and 8 from port 2 of 8031).
- POWER SUPPLY** : ±5V @ 500mA . All assembled in an well designed cabinet.
- ACCESSORIES** : 50 pin FRC Cable 1 No.

8051 Micro-Controller Trainer

Order Code - 43005

8051 Micro Controller Trainer uses 8051 versatile micro-controller. This controller finds extensive applications in automation. This is because of its architecture and built-in I/O capabilities. The use of this controller considerably reduces the chip count in the final product design. Hence this finds extensive applications in automatic vending machines, weighing machines, welding machines, microwave ovens etc. Therefore it becomes necessary to study the function and its capabilities, by experimentation. The Micro-controller trainer is an IBM PC/XT/AT & Pentium compatible instrument. This is a single PCB module. The instrument is connected to serial port of IBM computer at RS232C port. A 50 pin FRC connector provides unbuffered Address, Data and Control Lines. This may be used for system expansion at a later date.



Features:

01. In addition to this, it has features to modify and display internal as well as external memory locations.
02. Dump memory contents in some other location as specified.
03. Move a block of memory from a source address to destination address.
04. Execute from a specified memory location.
05. Display contents of all register and alter a few or all registers.
06. Facility to stop execution once a break point location reaches.
07. The unit is operative on 230V, 50 Hz A.C. Mains.
08. Strongly Supported by Detailed operating Instructions, giving details of Object, Theory, Design procedures, Report Suggestions and Book References.

Specifications:

- CPU** : 8051 Micro Controller 12MHz.
- MEMORY** : 32KB EPROM, 32 KB RAM and 2KB NV RAM. Battery Backup for RAM.
- PERIPHERALS** : 8279 for controlling 24 feather keys (including 6 digit seven segment display).
: 32 programmable I/O pins (24 from 8255 and 8 from port 2 of 8051).
- POWER SUPPLY** : ±5V @ 500mA . All assembled in an well designed cabinet.
- ACCESSORIES** : 50 pin FRC Cable 1 No.

DSP Lab Version 1.0

Order Code - 43006



Digital Signal Processing is a technique that converts signals from real world sources (usually in analog form)

into digital data that can then be analyzed. Analysis is performed in digital form because once a signal has been reduced to numbers; its components can be isolated, analyzed and rearranged more easily than in analog form. Eventually, when the DSP has finished its work, the digital data can be turned back into an analog signal, with improved quality. For example, a DSP can filter noise from a signal, remove interference, amplify frequencies and suppress others, encrypt information, or analyze a complex waveform into its spectral components.

DSP Lab 1.0 is an integrated solution for establishing DSP based Embedded System Lab, based on TI 6000 platform. Basically the lab is designed to learn about the signal processing in Digital Domain. DSP Lab is equipped with complete set of Hardware and Software to perform DSP experiments. The approach enables the understanding of real-time DSP systems principles and realworld applications using, C and various assembly programs based on TI's TMS320C6713 Processor. The processing power of the integrated 'C6713 (floating point) DSP allow real-time processing of high bandwidth data streams thereby reducing the processing load placed on the host CPU.

DSP Lab Contents

Tutors

LAB programming tutor for TI 6000 DSP

Specially developed tutor to support lab activity using DSP kit and CCS.

Development Tools

Code Composer Studio Platinum Edition V3.1 Supporting all TI DSP platforms.

DSK6713

DSP starter kit for Texas Instrument's TMS320C6713 DSP

Documentation

Installation workbook

The procedure to install code composer studio and DSP Lab 1.0

Technical Specifications DSK 6713

TMS320C6713 DSK : TMS320C6713 DSK development board

Other hardware : External 5 V DC power supply IEEE 1284 compliant male-to female cable Hardware Lock

CD : Code Composer Studio DSK

Other Accessories : tools, DSP Lab 1.0 Audio cables, Installation Manual, Experiments Work

- * MATLAB 7.0.4 (Trial version for 30 days)
- * Technical reference guide for TMS320C6713
- * The C6713 DSK has a TMS320C6713 DSP onboard that allows fullspeed verification of code with Code Composer Studio. The C6713 DSK provides :
- * A USB Interface
- * SD RAM and ROM
- * An analog interface circuit for Data conversion (AIC)
- * An I/O port
- * Embedded JTAG emulation support

Code Composer Features Include :

- * IDE
- * Debug IDE
- * Advanced watch windows
- * Integrated editor

- * Interactive profiling
- * Automated testing and customization via scripting Visual project management system

Scope of Learning:

01. Sampling & Waveform Generation
02. Quantization
03. PCM Encoding
04. Delta Modulation
05. Digital Modulation Schemes (ASK, PSK, FSK)
06. Error Correcting Codes
07. Read Write from CODEC
08. Fast Fourier Transform
09. FIR Filter implementation (Low Pass, High Pass Band Stop)
10. IIR Filter implementation
11. Linear Convolution
12. Auto Correlation
13. Power Spectral Density



Computer Interface Trainer + Optional Modules

Order Code - 43032 - 43039



Order Code -43032 Computer Interfacing Trainer is an excellent learning tool for starters for learning computer interfacing. 43032 or Optional Modules CIM-011 to 017 could be ideal training systems for learning "How hardware could be connected/ operated from PC". This training kit has been enriched by the ideas of students who have put their inputs in designing / developing the same. System housed in attractive enclosure is supplied with mains cord, 25-pin parallel cable and instruction manual.

Features:

01. Introduction to C Programming
02. Introduction to Interfacing through C Programming
03. Parallel / Printer Port Understanding in PC
04. Step by Step learning for "How hardware could be connected/ operated from PC"
05. In built Power Supply +5V@1A and +12V@200mA
06. Weight : 3 Kg (Approx.)
07. Dimension : W 340 x H 110 x D 210

Experiments Coverage:

01. Traffic Light Controller
02. 5 x 7 Matrix LED Display
03. Forward Reverse LED Display
04. Running Message Display
05. Seven Segment Display as a Calculator. Counter and Timer
06. Controlling of Electrical Appliances using PC

Accessories:

01. Mains Cord ----- 1
02. 25 Pin Parallel Male-Female Cable ----- 1
03. Instruction Manual ----- 1

Individual / Optional Modules:

Learners can buy 43033 to 43039 with all the 6 Experiments in one kit or they can buy these 7 Individual / Optional Modules, which can work independently. All the Individual modules are provided with Instruction Manual, 25 Pin Parallel Male-Female Cable and Adaptor (If necessary).

01. 43033 - Traffic Light Controller
02. 43034 - 5*7 Matrix LED Display
03. 43035 - Forward Reverse LED Display
04. 43036 - Running Message Display
05. 43037 - Seven Segment Display as Calculator, Counter and Timer
06. 43038 - Controlling of Electrical Appliances using PC.
07. 43039 - Interfacing of 3 to 8 Decoder

- * Weight : 0.7 Kg (Approx.)
- * Dimension : W 176 x H 131 x D 37

System Requirements:

01. PC with minimum P2, 400MHz, 128MB RAM
02. Operating System: Windows 98 / Windows XP
03. Programming Port : Parallel (LPT)
04. Software: Turbo C (Windows 98) or Borland Compiler (XP)

TMS 320C6745 DSP Trainer

Order Code - 43040



Specifications:

- * This DSP trainer kit uses Texas Instruments TMS320C6745 DSP chip a 375 MHz device delivering up to 3648 million instructions per second (MIPs) and MFLOPS
- * This DSP Trainer is specifically designed in a modular and user friendly format with many on board interfaces.

Hardware

- * JTAG supported via USB
- * TLV320AIC23B programmable stereo codec.
- * Two 3.5mm audio jacks for microphone and speaker
- * Expansion port for plug-in modules.
- * Power supply : +5V, ±12V, GND
- * 8 DIP switches for inputs and 8 LED indication for output
- * Provision for manual Reset
- * On board 4*4 LED matrix
- * On board white noise source of amplitude 0 ~ 5Vpp
- * On board 20*2 character LCD display.
- * On board 7 segment displays.
- * On board RTC interface : I2C based RTC section.
- * On board phone keypad : 0 to 9 digits and * , # characters.
- * Code composer studio for the TMS320C6745 is included.

Note:

- * JTAG to USB Programming cable for DSP has to be purchased separately.

Experiments:

- * To study the architecture of DSP chips - TMS320C6X instructions.
- * To verify linear and circular convolution.
- * To design FIR (LP/HP/BP) filters using windowing technique
 - (a) Using rectangular window
 - (b) Using triangular window
 - (c) Using kaiser window
- * To implement IIR(HP/LP/BP) using following window.
 - (a) Chebyshev filter
 - (b) Butterworth filter
- * N-point FFT algorithm
- * N-point DFT and IDFT of given sequence.
- * Frequency response of system which is given in transfer function and differential form.
- * Power spectrum density.
- * Generation of sine wave.
- * DFT and IFFT using DIT and DIF methods.
- * Auto-correlation, cross-correlation and it's property.
- * Sampling of sine signal.
- * Amplitude modulation, frequency modulation and FSK modulation.
- * FIR filter using Blackman and hamming window.
- * Generation of square wave
- * Implementation of decimation, interpolation and I/D sampling rate converter.
- * Impulse response of 1st and 2nd order system.
- * Addition and removal of noise.
- * Spectrogram of audio or sine signal.
- * Generation of DTMF signals and spectrogram of DTMF signal
- * RTC displayed on LCD
- * Signal companding using m-law.
- * Generation of sinusoidal wave based on recursive differential equation.
- * Generation of sinusoidal through filtering.
- * To find the FFT of given signal.
- * FIR filter using Fourier series expansion method.

Image processing

- * Digital image fundamentals
- * Image enhancement.
- * Image filtering
- * Image reconstruction
- * Color image processing
- * Image compression
- * Image Segmentation
- * Morphology image processing.

8085 Microprocessor Trainer Kit

Order Code - 43203



Order Code - 43203 is a single board Microprocessor Trainer Kit based on 8085 Microprocessor, which is widely used to train engineers to develop software/hardware for any industrial process & control. This Kit consists of power-full Monitor EPROM, RAM, I/O

Lines, Timer/Counter, Serial, Seven Segment Display and Keyboard for Man to Machine Interface.

Features

01. 8K Bytes of EPROM with 8K bytes of Battery Backup RAM.
02. 46 I/O Lines, Three Channel Timer/Counter, PC Serial Interface.
03. Seven Segment Display with 28 Keys Hex Keypad.
04. Power-full Command like Single Stepping, Break Point, Full Clock Execution, Examine Memory/Register.
05. Uploading & Downloading to and from PC in Windows98/XP/NT.
06. In-Built Power Supply.

Specifications:

- * Based on 8085 CPU operating at 6.144 Mhz.
- * 8K bytes of Powerful Monitor Program using 27512 EPROM 8K bytes of RAM using 6264 with Battery Backup using NICD Battery (Optional).
- * On-board one memory expansion up to 56KB.
- * Three Channel Timer/Counter using 8253 brought out at 10 Pins FRC Connector.
- * 24 I/O lines provided through 8255 brought out at 26 Pins FRC Connector to interface with IC-XX Series.
- * 22 I/O lines provided through 8155 brought out at 26 Pins FRC Connector .
- * RS-232C interface through SID/SOD lines
- * Two mode of commands:
 - Hex Key pad Mode
 - Serial Mode
- * Six Digit Seven Segment Display using 8279.
- * 28Key's Hex Keypad using 8279 Keyboard Display Controller.
- * Powerful Commands like Examine/Edit Memory, Examine/Edit Register, Single stepping, Execution, Block Move, Insert Data, Delete Data can be used through Hex keyboard or PC serial mode.
- * Facility for Downloading/Uploading files from/to PC.
- * All address, data & control lines are available on KXT Bus 50 pin FRC Connector to interface with SC-XX Series.
- * All ICS are mounted on IC Sockets.
- * Bare board Tested Glass Epoxy SMOBC PCB is used.
- * In-Built Power Supply of +5V/1.5A, ±12V/250mA
- * Attractive Box packaging.
- * User's Manual with sample programs.

Optional:

- * PRINTER INTERFACE to interface with DOT MATRIX Printer
- * RS-232 Cable

8085 Microprocessor Trainer Kit (LCD)

Order Code - 43204



43204 is a single board Microprocessor Trainer Kit based on 8085 Microprocessor, which is widely used to train engineers to develop software/hardware for any industrial process & control. This Kit consists of power-

full Monitor EPROM, RAM, I/O Lines, Timer/Counter, Serial, 20x2 LCD Display and Keyboard for Man to Machine Interface.

Features:

01. 16K Bytes of EPROM with 8K bytes of Battery Backup RAM.
02. 48 I/O Lines, Three Channel Timer/Counter, PC Serial Interface.
03. 20x2 LCD Display with 101 ASCII Keyboard.
04. Power-full Command like Single Stepping, Break Point, Full Clock Execution, Examine Memory/ Register.
05. Uploading & Downloading to and from PC in Windows98/XP/NT.
06. In-Built Power Supply.

Specifications:

- * Based on 8085 CPU operating at 6.144 Mhz.
- * 16K bytes of Powerful Monitor Program using 27512 EPROM
- * 8K bytes of RAM using 6264 with Battery Backup using NICD Battery.
- * On-board one memory expansion up to 56KB.
- * Three Channel Timer/Counter using 8253 brought out at 10 Pins FRC Connector.
- * 48 I/O lines provided through two nos. Of 8255 brought out at 26 Pins FRC Connector to interface with IC-XX Series.
- * RS-232C interface through SID/SOD lines
- * Two mode of commands:
 - ASCII Key pad Mode
 - Serial Mode
- * 20x2/20x4/40x2 Alphanumeric LCD Display with Backlite.
- * 101 ASCII Keyboard interface using 89C2051 operating @ 12MHz.
- * Powerful Commands like Examine/Edit Memory, Examine/Edit Register, Single stepping, Execution, Block Move, Insert Data, Delete Data can be used through ASCII keyboard or PC serial mode.
- * On board Single Line Assembler / Disassembler
- * Facility for Downloading/Uploading files from/to PC.
- * All address, data & control lines are available on KXT Bus 50 pin FRC Connector to interface with SC-XX Series.
- * All ICS are mounted on IC Sockets.
- * Bare board Tested Glass Epoxy SMOBC PCB is used.
- * In-Built Power Supply of +5V/1.5A, ±12V/250mA
- * Attractive Box Packaging.
- * User's Manual with sample programs.

Optional:

01. On-board EPROM Programmer for 2716,2732, 2764, 27128,27256, 27512.
02. PRINTER INTERFACE to interface with DOT MATRIX Printer.
03. RS-232 Cable.

8086 Microprocessor Trainer Kit

Order Code - 43211



43211 is a single board Microprocessor Trainer Kit based on 16 bit 8086 Microprocessor, which is widely used to train engineers to develop software/hardware for any industrial process & control. This Kit consists of power-full Monitor EPROM, RAM, I/O Lines, Timer/Counter, Serial, Seven Segment Display and Keyboard for Man to Machine Interface.

Features:

01. 16K Bytes of EPROM with 16K bytes of Battery Backup RAM.
02. 72 I/O Lines, Three Channel Timer/Counter, PC Serial Interface using USART, Interrupt Controller.
03. Seven Segment Display with 28 Keys Hex Keypad.
04. Power-full Command like Single Stepping, Break Point, Full Clock Execution, Examine Memory/ Register.
05. Uploading & Downloading to and from PC in Windows98/XP/NT.
06. In-Built Power Supply.

Specifications

- * 8086/8088 CPU operating at 2.5/5MHz
- * 8086 Processor can be replaced by 8088 Processor
- * On-board sockets provided to facilitate the use of 8087 Coprocessor and 8089 I/O Processor
- * 16K bytes of RAM using two nos. of 6264 with Battery Backup expandable up to 256KB.
- * 16K bytes of powerful monitor EPROM using two nos. of 27512
- * 72 I/O lines through 3 nos. of 8255 brought at 26 Pins FRC Connector to interface with IC-XX Series.
- * 16 bit Timer/Counter through 8253 brought out at 20 Pins FRC Connector.
- * RS-232C interface using 8251 brought out at 9 Pins D type Connector.
- * On-board Interrupt controller using 8259 brought out at 20 Pins FRC Connector.
- * 28 keys hexadecimal keyboard and eight seven segment display using 8279
- * Two modes of operation:
 - * Keyboard Mode
 - * Serial Mode
- * Powerful Commands like Examine/Edit Memory, Examine/Edit Register, Single stepping, Execution, Block Move can be used through hex keyboard or PC serial mode.
- * Facility for Downloading/Uploading files from/to PC.
- * All address, data & control lines are available on KXT Bus 50 pin FRC Connector to interface with SC-XX Series.
- * All ICS are mounted on IC Sockets.
- * Bare board Tested Glass Epoxy SMOBC PCB is used.
- * In-Built Power Supply of +5V/2A, ±12V/250mA
- * Attractive Box Packaging.
- * User's Manual with sample programs.

Optional:

01. PRINTER INTERFACE to interface with DOT MATRIX Printer
02. On-board EPROM Programmer for 2732 /2764 /27256
03. RS-232 Cable.

8086 Microprocessor Trainer Kit (LCD)

Order Code - 43212

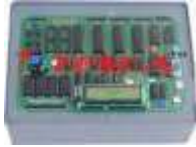

43212 is a single board Microprocessor Trainer Kit based on 16 bit 8086 Microprocessor, which is widely used to train engineers to develop software/hardware for any industrial process & control. This Kit consists of power-full Monitor EPROM, RAM, I/O Lines, Timer/Counter, Serial, LCD Display and Keyboard for Man to Machine Interface.

Features:

01. 16K Bytes of EPROM with 16K bytes of Battery Backup RAM.
02. 72 I/O Lines, Three Channel Timer/Counter, PC Serial Interface using USART, Interrupt Controller.
03. 20x2 LCD Display with 101 ASCII Keyboard.
04. Power-full Command like Single Stepping, Break Point, Full Clock Execution, Examine Memory/ Register.
05. Uploading & Downloading to and from PC in Windows 98/XP/NT.
06. In-Built Power Supply! 8086/8088 CPU operating at 2.5/5MHz

Specifications:

- * 8086 Processor can be replaced by 8088 Processor
- * On-board sockets provided to facilitate the use of 8087 Co-processor and 8089 I/O Processor
- * 6K bytes of RAM using two nos. of 6264 with Battery Backup expandable up to 256KB.
- * 16K bytes of powerful monitor EPROM using two nos. of 27512
- * 72 I/O lines through 3 nos. of 8255 brought at 26 Pins FRC Connector to interface with IC-XX Series.
- * 16 bit Timer/Counter through 8253 brought out at 20 Pins FRC Connector.
- * RS-232C interface using 8251 brought out at 9 Pins D type Connector.
- * On-board Interrupt controller using 8259 brought out at 20 Pins FRC Connector.
- * 20x2/40x2/20x4 Alphanumeric LCD Display with Backelite
- * 101 ASCII Keyboard interface using 89c2051 operating @ 12MHz
- * Powerful Commands like Examine/Edit Memory, Examine/Edit Register, Single stepping, Execution, Block Move can be used through ASCII Keyboard.
- * On-board Single Line Assembler & Disassembler.
- * Facility for Downloading/Uploading files from/to PC.
- * All address, data & control lines are available on KXT Bus 50 pin FRC Connector to interface with SC-XX Series.
- * All ICS are mounted on IC Sockets.
- * Bare board Tested Glass Epoxy SMOBC PCB is used.
- * In-Built Power Supply of +5V/2A, ±12V/250mA
- * Attractive Box Packaging.
- * User's Manual with sample programs.

Optional:

01. PRINTER INTERFACE to interface with DOT MATRIX Printer.

02. On-board Real Time Clock using RTC-6242.
03. RS-232 Cable.

8086 Microprocessor Trainer

Order Code - 43212A



43212A is a single board Microprocessor Trainer based on 16 bit 8086 Microprocessor, which is widely used to train engineers to develop software/hardware for any industrial process & control. This Trainer consists of power-full Monitor EPROM, RAM, I/O Lines, Timer/Counter, Serial, LCD Display and Keyboard for Man to Machine Interface.

Features:

01. 16K Bytes of EPROM with 16K bytes of Battery Backup RAM.
02. 72 I/O Lines, Three Channel Timer/Counter, PC Serial Interface using USART, Interrupt Controller.
03. 20x2 LCD Display with 101 ASCII Key board.
04. Power-full Command like Single Stepping, Break Point, Full Clock Execution, Examine Memory/ Register.
05. Uploading & Downloading to and from PC in Windows98/XP/NT.
06. In-Built Power Supply.

Specifications:

- * 8086/8088 CPU operating at 2.5/5MHz
- * 8086 Processor can be replaced by 8088 Processor
- * On-board sockets provided to facilitate the use of 8087 Co-processor and 8089 I/O Processor
- * 16K bytes of RAM using two nos. of 6264 with Battery Backup expandable up to 256KB.
- * 16K bytes of powerful monitor EPROM using two nos. of 27512
- * 72 I/O lines through 3 nos. of 8255 brought at 26 Pins FRC Connector to interface with IC-XX Series.
- * 16 bit Timer/Counter through 8253 brought out at 20 Pins FRC Connector.
- * RS-232C interface using 8251 brought out at 9 Pins D-Type Connector.
- * On-board Interrupt controller using 8259 brought out at 20 Pins FRC Connector.
- * On-board using ADC 0809 & DAC 0800 .
- * On-board Real Time Clock using RTC-6424.
- * On-board Temperature sensor using Lm35.
- * 8 bit digital switch for 8 digital input and 8 led for 8 digital output.
- * 20x2/40x2/20x4 Alphanumeric LCD Display with Backlite
- * 101 ASCII Keyboard interface using 89c2051 operating @ 12MHz
- * Powerful Commands like Examine/Edit Memory, Examine/Edit Register, Single stepping, Execution, Block Move can be used through ASCII Keyboard.
- * On-board Single Line Assembler & Disassembler.
- * Facility for Downloading/Uploading files from/to PC.
- * All address, data & control lines are available on KXT Bus 50 pin FRC Connector to interface with SC-XX Series.
- * All ICS are mounted on IC Sockets.

- * Bare board Tested Glass Epoxy SMOBC PCB is used.
- * In-Built Power Supply of +5V/2A, ±12V/250mA
- * Attractive ABS Plastic enclosures.
- * User's Manual with sample programs.

8051 Microcontroller Trainer Kit

Order Code - 43215



43215 is a single board Microcontroller Trainer Kit based on 8 bit 8051 Microcontroller, which is widely used to train engineers to develop on software/hardware for any industrial process & control. Kit has power-full Monitor EPROM, RAM, I/O Lines, Timer/Counter, Serial, LCD Display, Keyboard for Man to Machine Interface.

Features:

01. 16K Bytes of EPROM with 32K bytes of Battery Backup RAM.
02. 48 I/O Lines, Three Channel Timer/Counter, PC Serial Interface using USART, 12 bit ADC, DAC, RTC. 5 20x2 LCD Display with 101 ASCII Keyboard.
03. Power-full Command like Single Stepping, Break Point, Full Clock Execution, Examine Memory/ Register.
04. Uploading & Downloading to and from PC in Windows98/XP/NT.
05. In-Built Power Supply.

Specifications:

- * 8051/89C52/89C51RD2/89C61X2 CPU operating @11.0592MHz.
- * 32K user RAM using 6264 with Battery Backup using NICD Battery .
- * One socket is provided for RAM expansion up to 64K.
- * 16K bytes of powerful monitor EPROM using 27512.
- * 48 I/O lines using 2 Nos. of 8255 brought at 26 Pins FRC Connector to interface with IC-XX Series.
- * Three Channel Timer/Counter using 8253.
- * 20x2/40x2/20x4 Alphanumeric LCD Display with Backlite (Optional)
- * 101 ASCII Keyboard interface using 89c2051 operating @ 12MHz
- * On-board Single Line Assembler & Disassembler.
- * Two External interrupts INT0 & INT1 are available at 40 pin FRC connector.
- * RS-232C using RX/TX of 8051.
- * Two modes of operation:
- Keyboard Mode, Serial Mode.
- * Powerful Commands like Examine/ Edit Memory, Examine/Edit Register, Single stepping, Execution, Break Point can be used through ASCII keyboard or PC serial mode.
- * Facility for Downloading/Uploading files from/to PC.
- * All Address, Data, Control & Port lines are available on 40 Pins & 20 Pins FRC Connector.
- * All IC's are mounted on IC Sockets.
- * Bare board Tested Glass Epoxy SMOBC PCB is used.

- * In-Built Power Supply of +5V/1.5A, ±12V/250mA
- * Attractive Box Packaging.
- * User's Manual with sample programs.

Optional:

- * On-board ISP (In-system Programming) Facility.
- * PRINTER INTERFACE to interface with DOT MATRIX Printer.
- * RS-232C interface using 8251.
- * On-board 12 Bit ADC using Ad574.
- * On-board 8 bit DAC using DAC-0800.
- * On-board Real Time Clock using 6242.

8051 Microcontroller Trainer Kit with ADC, DAC

Order Code - 43215A



43215A is a single board Microcontroller Trainer Kit based on 8 bit 8051 Microcontroller, which is widely used to train engineers to develop on software/hardware for any industrial process & control. Kit has power-full Monitor EPROM, RAM, I/O Lines, Timer/Counter, Serial, LCD Display, Keyboard for Man to Machine Interface.

Features:

01. 16K Bytes of EPROM with 32K bytes of Battery Backup RAM.
02. 48 I/O Lines, Three Channel Timer/Counter, PC
03. Serial Interface using USART, 12 bit ADC, DAC, RTC.
04. 20x2 LCD Display with 101 ASCII Keyboard.
05. Power-full Command like Single Stepping, Break Point, Full Clock Execution, Examine Memory/ Register.
06. Uploading & Downloading to and from PC in Windows98/XP/NT.
07. In-Built Power Supply.

Specifications:

- * 8051/89C52/89C51RD2/89C61X2 CPU operating @11.0592MHz.
- * 32K user RAM using 6264 with Battery Backup using NICD Battery.
- * One socket is provided for RAM expansion up to 64K.
- * 16K bytes of powerful monitor EPROM using 27512.
- * 48 I/O lines using 2 Nos. of 8255 brought at 26 Pins FRC Connector to interface with IC-XX Series.
- * Three Channel Timer/Counter using 8253.
- * 20x2/40x2/20x4 Alphanumeric LCD Display with Backlite
- * 101 ASCII Keyboard interface using 89c2051 operating @ 12MHz
- * On-board Single Line Assembler & Disassembler.
- * Two External interrupts INT0 & INT1 are available at 40 pin FRC connector.
- * RS-232C using RX/TX of 8051.
- * Two modes of operation:
- Keyboard Mode, Serial Mode.
- * Powerful Commands like Examine/Edit Memory, Examine/Edit Register, Single stepping, Execution, Break Point can be used through ASCII keyboard or

- * PC serial mode.
- * Facility for Downloading/Uploading files from/to PC.
- * All Address, Data, Control & Port lines are available on 40 Pins & 20 Pins FRC Connector.
- * All IC's are mounted on IC Sockets.
- * Bare board Tested Glass Epoxy SMOBC PCB is used.
- * In-Built Power Supply of +5V/1.5A, ±12V/250mA
- * Attractive Wooden enclosures of Light weight Australian Pine Wood.
- * User's Manual with sample programs.
- * 270mm x 185mm x 105mm (L x W x H).
- * Weight 3 Kgs.

Optional

01. On-board ISP (In-system Programming) Facility.
02. PRINTER INTERFACE to interface with DOT MATRIX Printer.
03. RS-232C interface using 8251.
04. On-board 12 Bit ADC using Ad574.
06. On-board 8 bit DAC using DAC-0800.

80196 Microprocessor Trainer Kit

Order Code - 43216



43216 is a single board Microcontroller Trainer Kit based on 16 bit 8096 Microcontroller family, which is widely used to train engineers to develop on software/hardware for any industrial process & control. Kit has power-full Monitor EPROM, RAM, I/O Lines, Timer/ Counter, Serial, LCD Display, Keyboard for Man to Machine Interface.

Features:

01. 16K Bytes of EPROM with 16K bytes of Battery Backup RAM.
02. 24 I/O Lines, Three Channel Timer/Counter, PC Serial Interface .
03. Seven Segment Display with 25 Keys Hex Keypad.
04. Power-full Command like Single Stepping, Break Point, Full Clock Execution, Examine Memory/ Register.
05. Uploading & Downloading to and from PC in Windows98/XP/NT.
06. In-Built Power Supply.

Specifications:

- * 80196KB/80196KC/8051 CPU operating at 12 Mhz.
- * 16K bytes of RAM using two nos. of 6264 with Battery Backup using NICD Battery, Memory Expandable up to 64K.
- * 16K bytes of powerful monitor EPROM using 27512.
- * 24 I/O lines using 8255 brought at 26 Pins FRC Connector to interface with IC-XX Series.
- * RS-232c interface using Rx/Tx of 80196.
- * Eight Digital Seven Segment Display with 25 Keys hex keyboard using 8279.
- * On-chip 8 Channel 10 bit ADC.
- * On-chip PWM.

- * On-chip High speed I/O.
- * On-chip Interrupt.
- Two modes of operation:
 - Keyboard Mode.
 - Serial Mode.
- * Cross assembler software for 80196.
- * Powerful Commands like Examine/Edit Memory, Examine/Edit Register, Single stepping, Execution can be used through hex keyboard or PC serial mode.
- * Facility for Downloading/Uploading files from/to PC.
- * All Address, Data, Control & Port lines are available on 40 Pins & 20 Pins FRC Connector.
- * All IC's are mounted on IC Sockets.
- * Bare board Tested Glass Epoxy SMOBC PCB is used.
- * In-Built Power Supply of +5V/1.5A, ±12V/250mA
- * Attractive Wooden enclosures of Light weight Australian Pine Wood.
- * User's Manual with sample programs.

8085 Microprocessor Trainer

Order Code - 43217



43217 is a single board Microprocessor Trainer Kit based on 8085 Microprocessor, which is widely used to train engineers to develop software/hardware for any industrial process & control. This Kit consists of power-full Monitor EPROM, RAM, I/O Lines, Timer/Counter, Serial, Seven Segment Display and Keyboard for Man to Machine Interface.

Features:

01. 8K Bytes of EPROM with 8K bytes of Battery Backup RAM.
02. 22/24 I/O Lines Using 8155/8255, 46 I/O Lines Using 8255/8155, 48 I/O Lines Using 8255, Three Channel Timer/Counter, PC Serial Interface, Interrupt Controller, USART, RTC.
03. Seven Segment Display with 28 Keys Hex Keypad .
04. Power-full Command like Single Stepping, Break Point, Full Clock Execution, Examine Memory/ Register.
05. Uploading & Downloading to and from PC in Windows98/XP/NT.

Technical Specification:

- * Based on 8085 CPU operating at 6.144 Mhz.
- * 8K bytes of Powerful Monitor Program using 27512 EPROM
- * 8K bytes of RAM using 6264 with Battery Backup using NICD Battery(Optional).
- * On-board one memory expansion up to 56KB.
- * Three Channel Timer/Counter using 8253.
- * 24 I/O lines provided through 8255 brought out at 26 Pins FRC Connector to interface with IC-XX Series.
- * RS-232C interface through SID/SOD lines
- * Two mode of commands:
 - Hex Key pad Mode, Serial Mode
- * Six/Eight Digit Seven Segment Display using 8279.

- * On-board 8 Channel Interrupt using 8259.
- * On-board Auxillary Serial using 8251 USART brought out at 9 pin D-type connector.
- * 28Key's Hex Keypad using 8279 Keyboard Display Controller.
- * Powerful Commands like Examine/Edit Memory, Examine/Edit Register, Single stepping, Execution, Block Move, Insert Data, Delete Data can be used through Hex keyboard or PC serial mode.
- * Facility for Downloading/Uploading files from/to PC.
- * All address, data & control lines are available on KXT Bus 50 pin FRC Connector to interface with SC-XX Series.
- * All ICS are mounted on IC Sockets.
- * Bare board Tested Glass Epoxy SMOBC PCB is used.
- * In-Built Power Supply of +5V/1.5A, ±12V/250mA
- * Attractive Box Packaging.
- * User's Manual with sample programs.
- * 295mm x 210mm x 105mm (L x W x H).
- * Weight 3 Kgs.

Optional:

01. EPROM Programmer Module for 2716, 2732, 2764, 27128, 27256, 27512.
02. On-Board Real Time Clock using RTC-6242.
03. PRINTER INTERFACE to interface with DOT MATRIX Printer
04. RS-232 Cable.

8085 Microprocessor Trainer (LCD)

Order Code - 43218



43218 is a single board Microprocessor Trainer Kit based on 8085 Microprocessor, which is widely used to train engineers to develop software/hardware for any industrial process & control. This Kit consists of powerfull Monitor EPROM, RAM, I/O Lines, Timer/Counter, Serial, 16x1 LCD Display and Keyboard for Man to Machine Interface.

Features:

01. 16K Bytes of EPROM with 8K bytes of Battery Backup RAM.
02. 48 I/O Lines, Three Channel Timer/Counter, PC Serial Interface, ADC, DAC, Relay, Opto, Interrupt Controller, USART, EPROM Programmer.
03. 20x2 LCD Display with 101 ASCII Keyboard.
04. Power-full Command like Single Stepping, Break Point, Full Clock Execution, Examine Memory/ Register.
05. Uploading & Downloading to and from PC in Windows98/XP/NT.
06. In-Built Power Supply.

Technical Specifications:

- * Based on 8085 CPU operating at 6.144 Mhz.
- * 16K bytes of Powerful Monitor Program using 27512 EPROM
- * 8K bytes of RAM using 6264 with Battery Backup using NICD Battery.
- * On-board one memory expansion up to 56KB.

- * Three Channel Timer/Counter using 8253 brought out at 10 Pins FRC Connector.
- * 48 I/O lines provided through two nos. of 8255 brought out at 26 Pins FRC Connector to interface with IC-XX Series.
- * RS-232C interface through SID/SOD lines
- * Two mode of commands:
 - ASCII Key pad Mode
 - Serial Mode
- * 20x2/20x4/40x2 Alphanumeric LCD Display with Backlite.
- * 101 ASCII Keyboard interface using 89C2051 operating @ 12MHz.
- * On-board 8 Channel ADC using ADC0809.
- * On-board 1 Channel DAC using DAC-0800.
- * On-board SPDT Relay
- * On-board OPTO Isolator.
- * On-board 8 Ch. Interrupt Controller using 8259
- * On-board AUX. Serial using 8251 USART brought at 9 pin D-Type Connector.
- * On-board EPROM Programmer for 2716, 2732, 2764, 27128, 27256, 27512.
- * On-board Dot-Matrix Printer Interface brought at 25 Pin D-Type Connector.
- * Powerful Commands like Examine/Edit Memory, Examine/Edit Register, Single stepping, Execution, Block Move, Insert Data, Delete Data can be used through ASCII keyboard or PC serial mode.
- * On board Single Line Assembler / Disassembler
- * Facility for Downloading/Uploading files from/to PC.
- * All address, data & control lines are available on KXT Bus 50 pin FRC Connector to interface with SC-XX Series.
- * All ICS are mounted on IC Sockets.
- * Bare board Tested Glass Epoxy SMOBC PCB is used.
- * In-Built Power Supply of +5V/1.5A, ±12V/250mA
- * Attractive Wooden enclosures of Light weight Australian Pine Wood.
- * User's Manual with sample programs.
- * 315mm x 245mm x 105mm (L x W x H).
- * Weight 3 Kgs.

8085 Microprocessor Trainer (LCD)

Order Code - 43219

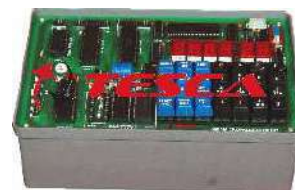

43219 is a single board Microprocessor Trainer Kit based on 8085 Microprocessor, which is widely used to train engineers to develop software/ hardware for any industrial process & control. This Kit consists of powerfull Monitor EPROM, RAM, I/O Lines, Timer/Counter, Serial, Seven Segment Display and Keyboard for Man to Machine Interface.

Features:

01. 8K bytes of EPROM with 8K bytes of battery backup RAM.
02. 48 I/O Lines, Three Channel Timer/Counter, PC Serial Interface.
03. Seven Segment Display with 28 Keys Hex Keypad.
04. Power-full Command like Single Stepping, Break

Point, Full Clock Execution, Examine Memory/ Register.

05. Uploading & Downloading to and from PC in Windows 98/XP/NT.
06. In-Built Power Supply.

Specifications:

- * Based on 8085 CPU operating at 6.144 Mhz.
- * 8K bytes of Powerful Monitor Program using 27512 EPROM
- * 8K bytes of RAM using 6264 with Battery Backup using NICD Battery.
- * On-board one memory expansion up to 56KB.
- * Three Channel Timer/Counter using 8253 brought out at 10 Pins FRC Connector.
 - 48 I/O lines provided through two nos. of 8255 brought out at 26 Pins FRC Connector to interface with IC-XX Series.
- RS-232C interface through SID/SOD lines
- Two mode of commands:
 - Hex Key pad Mode
 - Serial Mode
- Six Digit Seven Segment Display using 8279.
- 28Key's Hex Keypad using 8279 Keyboard Display Controller.
- Powerful Commands like Examine/Edit Memory, Examine/ Edit Register, Single stepping, Execution, Block Move, out at 10 Pins FRC Connector.
- * 48 I/O lines provided through two nos. of 8255 brought out at 26 Pins FRC Connector to interface with IC-XX Series.
- * RS-232C interface through SID/SOD lines
- * Two mode of commands:
 - Hex Key pad Mode
 - Serial Mode
- * Six Digit Seven Segment Display using 8279.
- * 28Key's Hex Keypad using 8279 Keyboard Display Controller.
- * Powerful Commands like Examine/Edit Memory, Examine/ Edit Register, Single stepping, Execution, Block Move, Insert Data, Delete Data can be used through Hex keyboard or PC serial mode.
- * Facility for Downloading/Uploading files from/to PC.
- * All address, data & control lines are available on KXT Bus 50 pin FRC Connector to interface with SC-XX Series.
- * All ICS are mounted on IC Sockets.
- * Bare board Tested Glass Epoxy SMOBC PCB is used.
- * In-Built Power Supply of +5V/1.5A, ±12V/250mA
- * Attractive ABS Plastic enclosures.
- * User's Manual with sample programs.
- * 270mm x 185mm x 105mm (L x W x H).
- * Weight 3 Kgs.

Optional:

01. PRINTER INTERFACE to interface with DOT MATRIX Printer

Peripherals Study Card

Order Code - 43225 to 43284



Study Cards can be connected to the 50 Pins KXT Bus of any 8/16 bit Series Microprocessor Trainer Kits. In this Study Card LED's are provided for different signals like Read, Write, Address Lines, Data Lines, Chip Select & Ports depending upon the Peripherals.Study

43275 - 8255 (PPI) STUDY CARD

- * 24 bit I/O using 8255 Programmable Peripheral IC
- * All Input/Output ports pins are terminated on 3 eight pin terminals & 26 pin FRC Connector
- * All Input/Output ports are indicated by 3 mm LEDs.
- * Data lines from AD0 to AD7 are indicated by 3mm LEDs.
- * Chip Select, A0, A1, Read, Write are indicated by 3mm LEDs.
- * Hardware Single Step and Full Clock Execution mode are provided.
- * Single stepping can be performed using micro switch provided on board.
- * Using this study card all MODE experiment can be performed.
- * Interface 8085/8086 Kit using 50 pin FRC Connector.
- * User's Manual with Sample Programs.

43276 - 8253 (PTC) STUDY CARD

- * Three channel Timer/Counter using 8253 Programmable Timer Counter IC.
- * All Input/Output ports pins are terminated on terminals & 10 pin FRC Connector.
- * Clock for Counter-0 is internally provided.
- * Data lines from AD0 to AD7 are indicated by 3mm LEDs.
- * Chip Select, A0, A1, Read, Write are indicated by 3mm LEDs.
- * Hardware Single Step and Full Clock Execution modes are provided.
- * Single stepping can be performed using micro switch provided on board.
- * Card are supplied in Australian Pine Wood Enclosure.
- * Using this study card all MODE experiment can be performed.
- * Interface 8085/8086 Kit using 50 pin FRC Connector.
- * User's Manual with Sample Programs.

43277 - 8155 (PPI WITH TIMER) STUDY CARD

- * 22 bit I/O with single channel timer using 8155 Programmable Peripherals IC
- * All Input/Output ports pins are terminated on 3 eight pin terminals & 26 pin FRC Connector
- * All Input/Output ports are indicated by 3 mm LEDs.
- * Data lines from AD0 to AD7 are indicated by 3mm LEDs.
- * Chip Select, IO, Memory, Read, Write are indicated by 3mm LEDs.
- * Hardware Single Step and Full Clock Execution modes are provided.
- * Single stepping can be performed using micro switch provided on board.
- * Using this study card all MODE experiment can be performed.
- * Interface 8085/8086 Kit using 50 pin FRC Connector.
- * User's Manual with Sample Programs.

43278 - 8251 (USART) STUDY CARD

- * Serial communication using 8251 Universal Synchronous/ Asynchronous Receiver Transmitter IC.
- * Output are provided on 9 pin D-Type connector.
- * Data lines from AD0 to AD7 are indicated by 3mm LEDs.
- * Chip Select, Read, Write, A0, A1, DTR, DSR, RTS, CTS, TxRDY, RxRDY are indicated by 3mm LEDs.
- * Hardware Single Step and Full Clock Execution modes are provided.
- * Single stepping can be performed using micro switch provided on board.
- * Using this study card all MODE experiment can be performed.
- * Interface 8085/8086 Kit using 50 pin FRC Connector.
- * User's Manual with Sample Programs.

43279 - 8257 (DMA) STUDY CARD

- * Programmable Direct Memory Access controller using 8257 IC.
- * On-board 2K RAM Provided using 6116 IC for DMA Operation.
- * 8 Inputs are fed through input terminals with 3 mm LED

indicator.

I Data lines from AD0 to AD7 are indicated by 3mm LEDs.

I Chip Select, Read, Write, A0, A1, A2, A3, Memory-Write, Memory-Read, IO-Write, IO-Read are indicated by 3mm LEDs.

I AEN, Mark, TC, HRQ, DACK0, DACK1, DACK2 are indicated by 3mm LEDs.

indicator.

- * Data lines from AD0 to AD7 are indicated by 3mm LEDs.
- * Chip Select, Read, Write, A0, A1, A2, A3, Memory-Write, Memory-Read, IO-Write, IO-Read are indicated by 3mm LEDs.
- * AEN, Mark, TC, HRQ, DACK0, DACK1, DACK2 are indicated by 3mm LEDs.
- * Hardware Single Step and Full Clock Execution modes are provided.
- * Single stepping can be performed using micro switch provided on board.
- * Using this study card all MODE experiment can be performed.
- * Interface 8085/8086 Kit using 50 pin FRC Connector.
- * User's Manual with Sample Programs.

43280 - 8259 (PIT) STUDY CARD

- * 8 Channel Programmable Interrupt controller using 8259 IC.
- * 8 Inputs interrupts are fed through input terminals.
- * Data lines from AD0 to AD7 are indicated by 3mm LEDs.
- * Chip Select, Read, Write, INTA, INTR are indicated by 3mm LEDs.
- * Hardware Single Step and Full Clock Execution modes are provided.
- * Single stepping can be performed using micro switch provided on board.
- * Using this study card all MODE experiment can be

performed.

- * Interface 8085/8086 Kit using 50 pin FRC Connector.
- * User's Manual with Sample Programs.

43281 - 8279 (PKDC) STUDY CARD

- * Programmable Keyboard Display Controller using 8279 IC.
- * All scan lines/return lines are fed through input terminals & 26 pin FRC connector.
- * Data lines from AD0 to AD7 are indicated by 3mm LEDs.
- * Chip Select, Read, Write, INTA, A0 are indicated by 3mm LEDs.
- * Hardware Single Step and Full Clock Execution mode are provided.
- * Single stepping can be performed using micro switch provided in the board.
- * 8 Digit Seven Segment display with 20 keys keypad interface module to be interfaced with 8279 Study Card. (OPTIONAL)
- * Using this study card all modes experiment can be performed.
- * Interface 8085/8086 Kit using 50 pin FRC Connector.
- * User's Manual with Sample Program.

43282 - 8212 (LATCH) STUDY CARD

- * 8 bit Latch output using 8212 IC
- * 8 buffered latch output are indicated by 3mm LEDs.
- * Hardware Single Step and Full Clock Execution modes are provided.
- * Single stepping can be performed using micro switch provided on board.
- * Using this study card all MODE experiment can be performed.
- * Interface 8085/8086 Kit using 50 pin FRC Connector.
- * User's Manual with Sample Programs.

43283 - LATCH / BUFFER STUDY CARD

- * 8 bit Latch output using 74373 IC.
- * 8 bit Buffer input using 74245 IC.
- * 8 buffered latch output are indicated by 3mm LEDs.
- * Eight Way DIP Switch is provided for buffer input.
- * Eight bit buffered output are indicated by 3mm LEDs.
- * Chip Select for IC-74245 and IC-74373 are indicated by 3mm LEDs.
- * Hardware Single Step and Full Clock Execution modes are provided.
- * Single stepping can be performed using micro switch provided on board.
- * Using this study card all MODE experiment can be performed.
- * Interface 8085/8086 Kit using 50 pin FRC Connector.
- * User's Manual with Sample Programs

43284 - 6116/ 6264/ 62256 RAM STUDY CARD

- * Data lines from AD0 to AD7 are indicated by 3mm LEDs.
- * Chip Select, Read, Write are indicated by 3mm LEDs.
- * Hardware Single Step and Full Clock Execution modes are provided.

- * Single stepping can be performed using micro switch provided on board.
- * Using this study card all MODE experiment can be Performed
- * Interface 8085/8086 Kit using 50 pin FRC Connector.
- * User's Manual with Sample Programs.

68000 Microprocessor Trainer 16 Bit

Order Code - 43307



Trainer is a powerful and cost-effective complete single-board microprocessor based on the Motorola 68000 CPU supported by the popular peripheral chips from Motorola. The powerful system monitor includes one-line assembler for mnemonic entry, disassembler and Centronics printer interface driver in addition (0 the user friendly set of debug monitor commands. ABORT facility permits graceful recovery, preserving the complete user context, from "STUCK" programs. It is supported by a wide verity of interface modules making it an extremely useful educational aid. Careful bus arbitration design permits the access of all on-board resources by an off-board master making it easy to expand It into a multi-master configuration. Thus It is a valuable aid for teaching, software and hardware development in academic institutions, research institutions and R&D labs.

Features:

01. Operates on single +5V power supply with a PC compatible system through its RS 232 C serial communication interface.
02. Powerful system monitor permits entry of programs, debugging through breakpoint, trace and instruction step facilities.
03. Hardware debugging through Read loop, Write loop and Test memory commands.
04. Built-in one line assembler and disassembler.
05. Centronics printer Driver included in the monitor Program.
06. Interfacing with PC compatibles, with file upload / download capability.
07. Provision for multi-master design expansion.
08. ABORT facility to recover gracefully from "STUCK" programs.
09. Flexible and powerful interrupt system.
10. Supported by a variety of interface modules.

Accessories (optional):

01. Interface Modules: Keyboard, Elevator, Display, ADC using DAC, Dual Slope ADC, Dual DAC, Logic Controller, Traffic Lights, RTC, 18 Column Numeric Printer etc.,
02. 68020 / 68881 upgrade: A plug in replacement for 68000 processor which allows all the advanced features of the 68020 and 68681.
03. Centronics printer interface cable.
04. SO core ribbon cable connector set.

CPU : 68000 at 8 MHZ

MEMORY

ROM : Four JEDEC compatible 28 pin sockets provide. 128K Bytes using 4 X 27256 256K

Bytes using 4 X 27512 System firmware is supplied in 2 X 27256. Rest is for user expansion.

RAM : Four 28-pin sockets Logive 128K bytes using 4 X 62256. 64K Bytes supplied using 2 X 62256. Reset is for user expansion

Peripherals:

- * 68681 Dual UART :
- * To provide two RS-232C Ports 8 output lines, counter timer etc.
- * 68230 Parallel Interface I Timer:
- * To provide 16 I/O lines, 8 user defined lines and 24 bit counter timer with 5 bit (+32) prescaler.

Interrupts:

- * On-board interrupt priority encoder, On-board autovector generation. Complete flexibility in selecting on-board / off-board interrupt sources. Level 7 interrupt is dedicated for implementing ABORT function.

Bus

- * Buffered TTL Compatible bus signals brought out to Spectra Strip type 50 pin ribbon cable connector for easy expansion. Bus arbitration signals available on connector. Provision for accessing on-board resources by off board Master.

Interface Signals

- * Parallel 110 : 24 lines of TTL compatible signals brought out to Spectra Strip type 26 pin ribbon cable connectors.
- * Serial 110 : Two RS 232 C ports with standard MODEM control signals through on-baord 9 pin D-type connectors.

Scope of Supply

01. 68K-2 Trainer
02. XT68K-2 Driver Software
- 03 RS-232C cables set.
04. User's Manual

89C51 Embedded Trainer

Order Code - 43501



Order Code - 43501 is a single board Universal Embedded Kit based on MCU (Philips 89C61X2) Microcontroller for any Embedded Applications.

Feature:

01. CPU: Philips 89C61X2 Microcontroller
02. ISP Programming facility

Onboard Application:

01. 8 LEDs to display Digital Output
02. 8 Switches to give Digital Input each indicated by LED
03. 16*2 Alphanumeric LCD
04. 4 digit Seven segment displays
05. I2C compatible
 - 24C512 EEPROM (64KB)
 - DS1307 RTC with suitable battery
 - 4 Ch. 8bit ADC & 8 bit DAC using PCF8591

06. Temperature sensor interface Temperature sensor interface
08. 24 I/O Lines Provided on a 26 pin FRC Connector for external interface
09. On board supply +/- 12V, 5V is provided
10. Supply Input Voltage: 230VAC
11. User's Manual with sample programs for all on board features
07. Temperature sensor interface DS18B20
08. 24 I/O Lines Provided on a 26 pin FRC Connector for external interface
09. On board supply +/- 12V, 5V is provided
10. Supply Input Voltage: 230VAC
11. User's Manual with sample programs for all on board features

LPC2148 ARM Embedded Trainer

Order Code - 43502



Order Code - 43502 is a single board Universal Embedded Kit based on ARM (Philips LPC2148) Microcontroller for any Embedded applications.

Feature:

01. CPU: Philips LPC 2148 Microcontroller
02. ISP Programming facility

Onboard Application

01. 8 LEDs to display Digital Output
02. 8 Switches to give Digital Input each indicated by LED
03. 16*2 Alphanumeric LCD
04. 4 digit Seven segment displays
05. I2C compatible
 - 24C512 EEPROM (64KB)
 - DS1307 RTC with suitable battery
 - 4 Ch. 8bit ADC & 8 bit DAC using PCF8591
06. Temperature sensor interface Lm35
07. Temperature sensor interface DS18B20
08. 24 I/O Lines Provided on a 26 pin FRC Connector for external interface
09. On board supply +/- 12V, 5V is provided
10. Supply Input Voltage: 230VAC
11. User's Manual with sample programs for all on board features

PIC16F877A/ 18F452 Embedded Trainer

Order Code - 43503



Order Code - 43503 is a single board Universal Embedded Kit based on PIC (Microchip 16F877A / 18F452) Microcontroller for any Embedded applications.

Feature:

01. CPU: Microchip 16F877A / 18F452 Microcontroller
02. ISP Programming facility

Onboard Application

01. 8 LEDs to display Digital Output
02. 8 Switches to give Digital Input each indicated by LED
03. 16*2 Alphanumeric LCD
04. 4 digit Seven segment displays
05. I2C compatible
 - 24C512 EEPROM (64KB)
 - DS1307 RTC with suitable battery
 - 4 Ch. 8bit ADC & 8 bit DAC using PCF8591
06. Temperature sensor interface Lm35
07. Temperature sensor interface DS18B20 24 I/O Lines Provided on a 26 pin FRC Connector for external interface
08. On board supply +/- 12V, 5V is provided
09. Supply Input Voltage: 230VAC
10. User's Manual with sample programs for all on board features

ATMEGA32 AVR Embedded Trainer

Order Code - 43504



Order Code - 43504 is a single board Universal Embedded Kit based on AVR (ATMEL Atmega32) Microcontroller for any Embedded applications.

Feature:

01. CPU: ATMEL Atmega32 Microcontroller
02. ISP Programming facility

Onboard Application:

01. 8 LEDs to display Digital Output
02. 8 Switches to give Digital Input each indicated by LED
03. 16*2 Alphanumeric LCD
04. 4 digit Seven segment displays
05. I2C compatible
 - 24C512 EEPROM (64KB)
 - DS1307 RTC with suitable battery
 - 4 Ch. 8bit ADC & 8 bit DAC using PCF8591
06. Temperature sensor interface Lm35
07. Temperature sensor interface DS18B20
08. 24 I/O Lines Provided on a 26 pin FRC Connector for external interface
09. On board supply +/- 12V, 5V is provided
10. Supply Input Voltage: 230VAC
11. User's Manual with sample programs for all on board features

PI C Embedded Trainer

Order Code - 43505



Specifications:

- * CPU: Microchip 18F4550 operating on crystal frequency @ 20MHz.
 - On-chip 32KB Flash memory and 2048 byte SRAM.

- On-chip 256byte EEPROM.
- On-chip UART, SPI, I2C, PWM.
- On-chip 8 Channel 10 bit ADC.
- On-chip 32 I/O Lines are provided in four 16 pin Connector.
- CPU provided on ZIF Socket.
- * ISP Programming facility.
 - 10 pin ISP Connector provided on board for Programming.
 - ISP selection Key is provided
 - USB based JTag Programmer/Recorder in metal enclosure.
- * On-board Reset Key.
- * Mini Signal Generator
 - Fixed TTL clock of frequencies 10 Hz, 100 Hz, 1KHz & 10 KHz.
- * Onboard Applications
 - 8 LED's to display Digital Output.
 - 8 Switches to give Digital Input indicated by LED's.
 - 2 Bicolor LEDs to display.
 - 16x2 Alphanumeric LCD backlit display.
 - 4x4 Matrix Keyboard.
 - 500 Tie Points Bread Board Area provided
- * Piezoelectric Buzzer.
- * SPI Digital Potentiometer using MCP41010
- * Four nos. of 12V SPDT Relay.
- * 4 digit seven segment displays.
- * 8 inputs & 8 Outputs are Optically Isolated using Pc817
- * 12V DC Motor interface Photo detector assembly
- * I2C compatible:
 - 24C512 EEPROM (64KB)
 - DS1307 RTC with suitable battery
 - 4Ch. 8bit ADC & 1Ch. 8 bit DAC using PCF8591.
- * Temperature sensor interface using Lm35.
- * Resistive Heater for Temperature Sensor.
- * Temperature sensor interface using DS18B20.
- * RS232 Serial Interface provided through 9 Pin D-Type Connector
- * 24 I/O Lines Provided on a 26 pin FRC Connector for external interface.
- * On board supply + 12V/1A, 5V/2A is Provided.
 - Supply Input Voltage: 230V AC.
 - All ICS are mounted on IC Sockets.
 - Bare board Tested Glass Epoxy SMOBC PCB is used.
 - Attractive Metallic enclosures.
 - 9 Pin Serial Cable & USB Cable Provided
 - Software in windows XP/2000
 - User's Manual with sample programs for all on board features

PIC Development Trainer

Order Code - 43506



43506 is a single board Universal Embedded Trainer based on PIC (Microchip 16F877A / 18F452) Microcontroller for any Embedded applications.

Specifications:

- * Microcontroller
 - Microchip 5CPU: 16F877A / 18F452

Microcontroller

- 5ISP Programming facility All I/O Lines should be provided in 2mm connector for Bread board connectivity through 2 mm to 0.8 mm Patch Cord.
- On board Reset key
- On board 10 pin connector for ISP Programming facility with separate USB based ISP Programmer module for burning the controller.
- * Onboard Applications
 - 4 LED's to display Digital Output.
 - 4 Toggle Switches to give Digital Input indicated by LED's.
 - 4 Push button Switches to give Digital Input indicated by LED's.
 - 16x2 Alphanumeric LCD backlit display
 - 4x4 Matrix Keyboard
 - 600 Tie Points Bread Board Area provided
 - 4 nos. of Power Relay Interface.
 - 4 digit seven segment displays.
 - RS232 Serial Interface provided through 9 Pin D-Type Connector
- * On board supply + 12V/1A, 5V/2A is provided.
- * Supply Input Voltage: 230V AC.
- * All ICS are mounted on IC Sockets.
- * Bare board Tested Glass Epoxy SMOBC PCB is used.
- * Attractive ABS Plastic enclosures.
- * Set of 2mm Patch cords for interconnections
- * 9 Pin Serial Cable & USB Cable Provided
- * Software in windows XP/2000
- * User's Manual

89S52 Microcontroller Trainer

Order Code - 43507



43507 is a single board Microcontroller Trainer based on 8 bit 8051 Microcontroller, which is widely used to train engineers to develop on software/ hardware for any industrial process & control. Kit has onboard Interfaces like EPROM, RAM, 8255PPI, LCD, Seven Segment Display, Keyboard Matrix, Relay, Buzzer, ADC, DAC, Stepper Motor, General Purpose Breadboard, Ps2 Keyboard for Man to Machine Interface.

Specifications:

- * Microcontroller
 - CPU: Atmel 89s52 Microcontroller operating @ 11.0592 MHZ crystal.40 Pin ZIF socket for Microcontroller.
 - All I/O Lines should be provided in 4 separate 16 pin female connector for Bread board connectivity through single stand wires & 50 PIN FRC connector for external interface.
 - Internal memory: 8K (flash memory).
 - Onboard CPLD Device XC9572 for memory & I/O mapping
 - On board Reset key
 - 4 way DIP Switch for Simulating P1 inputs microcontroller lines
 - 8 Led's for Simulating P1 outputs microcontroller lines

- Should have On board 5 keys for INT0, INT1, T0, T1, T2 microcontroller.
- On board USB based ISP Programmer module for burning the controller.
- On board RS-232 interface provided at 9 Pin D-type connector
- On board RS-485 interface provided at KRE Connector
- On board USB interface provided at USB
- * Memory
 - User Data RAM area: 32KB.
 - User Program / Data RAM area: 32KB.
 - Memory mapped I/O Area.
- * Onboard Applications
 - 16 LED's to display Digital Output.
 - 8 Switches to give Logic Level Input.
 - 600 Tie Points Bread Board Area provided
 - Piezoelectric Buzzer.
 - Four nos. of 12V SPDT Relay output terminated at 3 pin KRE connector.
 - 4 digit seven segment displays.
 - 16 x 2 Alphanumeric LCD display Module/ 128 x 64 Graphic LCD display interface.
 - PS/2 keyboard port Interface 2 fæ I C based DS1307 RTC IC interface with Battery Backup.
 - 4 x 4 Matrix Key Interface.
 - On board 8 Ch. 8bit ADC having 3 channel 5V range, 1 channel 10V range, 4-20mA range, Thermocouple input, Temperature sensor Lm35 & 1 channel Potentiometer input.
 - On board 8 bit DAC using DAC0800 output of 5V & 10V range provided at KRE Connector.
 - One onboard 12 Volt Stepper Motor interface.
 - Four SINK output with 200mA terminated at KRE connector
 - 24 I/O lines using 8255 IC are terminated at 26 pin FRC connector.
- * On board supply ± 12V/1A, 5V/2A is Provided.
- * Supply Input Voltage: 110Volts to 230 volts AC at 50Hz/60Hz.
- * 26 Pin FRC Cable, 50 Pin FRC Cable, 9 Pin Serial Cable & USB Cable Provided.
- * All ICS are mounted on IC Sockets.
- * Bare board Tested Glass Epoxy SMOBC PCB is used.
- * Attractive Metal/ Wooden enclosures.
- * Software in windows XP/2000.
- * User's Manual with sample programs in 'C' language for all on board features

Universal Embedded Trainer & Piggy Back Modules with Interfaces

Order Code - 43511 to 43525



Order Code - 43511 Universal Embedded Trainer

Order Code - 43511 is a single board Embedded Kit based on ARM, AVR, 89CXX, PIC Microcontrollers for any Embedded applications.

Feature:

- 01. Optional- Not Included - Daughter CPU Boards for

- 43512 - Philips 89C61X2 Microcontroller.
 - 43513 - Microchip PIC 16F877A Microcontroller.
 - 43514 - Microchip PIC 18F452 Microcontroller.
 - 43515 - Philips ARM LPC 2148 Microcontroller.
 - 43516 - ATMEL ATmega32 Microcontroller.
02. ISP Programming facility for all Microcontrollers.

Onboard Applications

01. 16 LED's to display Digital Output.
02. 16 Switches to give Digital Input indicated by LED's.
03. 16x2 Alphanumeric LCD backlit display.
04. 4x4 Matrix Keyboard.
05. Miniature Buzzer.
06. 12V SPDT Relay.
07. 4 digit seven segment displays.
08. I2C compatible:
 - 24C512 EEPROM (64KB).
 - DS1307 RTC with suitable battery.
 - 4Ch. 8bit ADC & 1Ch. 8 bit DAC using PCF8591.
09. Temperature sensor interface using
10. Temperature sensor interface using
11. 24 I/O Lines Provided on a 26 pin FRC Connector for external interface.
13. On board supply +/- 12V, 5V, 3.3V, 2.5V, 1.5V & 1.2V is provided.
14. Supply Input Voltage: 230VAC.
15. All ICS are mounted on IC Sockets.
16. Bare board Tested Glass Epoxy SMOBC PCB is used.
17. Attractive Wooden enclosures of Light weight Australian Pine Wood.
18. User's Manual with 'C' source code sample programs for all on board applications.

Order Code 43512 89CXX Piggy-bag Module

Feature:

01. CPU: Philips 89C61x2 operating @ 11.0592MHz.
02. On-chip 64KB Flash memory and 1KB RAM.
03. On-chip UART, PWM.
04. On-chip 32 I/O Lines are provided in 40 pin Conn.
05. On-board Reset Key.
06. On-board ISP Programming.

Order Code - 43513 & 43514

PIC Piggy-bag Module

Feature:

01. CPU: Microchip 18F452 operating @ 4MHz.
02. On-chip 32KB Flash memory and 1536 byte RAM.
03. On-chip 256byte EEPROM .
04. On-chip UART, SPI, I2C, PWM.
06. On-chip 8 Channel 10 bit ADC .
07. On-chip 32 I/O Lines are provided in 40 pin Conn.
08. On-board Reset Key.
09. ISP Programming (Optional).

Order Code - 43515 ARM Piggy-bag Module

Feature:

01. CPU: Philips LPC2148 operating @ 12MHz.
02. 16 bit / 32bit ARM7 TDMI-S Microcontroller.
03. On-chip 512KB Flash memory and 40KB RAM.
04. On-chip 14 Ch. 10 bit ADC and 1 Ch. 10bit DAC.
05. On-chip Real Time Clock, UART, SPI, SSP, I2C, PWM.
06. On-chip 48 I/O Lines are provided in 40 pin Conn.
07. On-board Reset Key.
08. On-board ISP Programming.

Order Code - 43516 AVR Piggy-bag Module

Feature:

- 01. CPU: Atmel ATmega32 operating @ 4MHz.
 - 02. On-chip 32KB Flash memory and 1KB RAM.
 - 03. On-chip 512byte EEPROM .
 - 04. On-chip UART, SPI, I2C, PWM.
 - 05. On-chip 8 Channel 10 bit ADC .
 - 06. On-chip 32 I/O Lines are provided in 40 pin Conn.
 - 07. On-board Reset Key.
 - 08. ISP Programming (Optional).
- Optional Addon Boards
- 01. Order Code 43521 - Stepper Motor Controller with Motor.
 - 02. Order Code 43522 - Traffic Light Controller.
 - 03. Order Code 43523 -128x64 Graphic LCD Display.
 - 04. Order Code 43524 - Servo Motor.
 - 05. Order Code 43525 - PS2 Keyboard.
 - 06. ISP Programmer for PIC & AVR.
 - 04. On-chip UART, SPI, I2C, PWM.
 - 05. On-chip 8 Channel 10 bit ADC .
 - 06. On-chip 32 I/O Lines are provided in 40 pin Conn.
 - 07. On-board Reset Key.
 - 08. ISP Programming (Optional).

Optional Addon Boards

- 01. Order Code 43521 - Stepper Motor Controller with Motor.
- 02. Order Code 43522 - Traffic Light Controller.
- 03. Order Code 43523 -128x64 Graphic LCD Display.
- 04. Order Code 43524 - Servo Motor.
- 05. Order Code 43525 - PS2 Keyboard.
- 06. ISP Programmer for PIC & AVR.

Universal Embedded Trainer

Order Code - 43511A



43511A is a single board Universal Trainer Kit which is widely used to train engineers to develop/ Study hardware and software for any large scale integrated circuit application in laboratory. This board having logic inputs, output indicator LED's, Push Switch Key, LCD Display, Matrix Keyboard, Stepper motor, Relay, Buzzer, Rs232, Matrix Display, DC Supplies for experimenting very large scale integration techniques.

Specifications:

- * Piggy Bag Daughter Board.
 - Piggy Bag XILINX SPARTAN XC3S50 FPGA (optional)
 - Piggy Bag XILINX SPARTAN XC3S400 FPGA (optional)
- * On board USB JTAG Programmer for configuring XILINX Device.
- * Display Indicator
 - 16 LED's indicator for input/output ports of the FPGA.
 - Six digit seven segment display.
 - 16x2 Alpha-numeric LCD Display with the backlight.
 - Two Dices LED's (Dice-1 and Dice-2)
 - 8x8 Dot Matrix Display.
- * Switches

- 2nos. of 8 pin DIP Switches for input selection.
- 8 Push button Switches with LED indicator.
- 3 Pulse Generator Switches for High to Low transition with LED indicator.
- 3 Pulse Generator Switches for Low to High transition with LED indicator.
- 5x4 matrix key board.
- * Onboard Interfaces
 - RS-232C Serial connector.
 - Miniature Buzzer.
 - 12V SPDT Relay.
 - Stepper Motor Controller.
 - On-board Reset Key.
 - 1Ch. 8 bit ADC using ADC 0804.
 - Two 8 bit DAC using DAC 0800.
 - Temperature sensor interface using Lm35.
- * Clock Generator
 - On-board 20MHz Oscillator.
 - 20 MHz clock and one of nine different frequency clocks (1Hz, 10Hz, 100Hz, 1 KHz, 10 KHz, 100 KHz, 1 MHz, 10MHz & 20 MHz).
- * Four set of 20x2 Female berg connector to plug-in the DAUGHTER BOARD.
- * Supply Input Voltage: 230V AC.
- * All IC's are mounted on IC Sockets.
- * Bare board Tested Glass Epoxy SMOBC PCB is used.
- * Attractive Metal/ Wooden enclosure.
- * User's Manual with 'VHDL' Source code sample programs for all on board applications.

Universal VLSI (FPGA /CPLD) Trainer

Order Code - 43540 to 43550

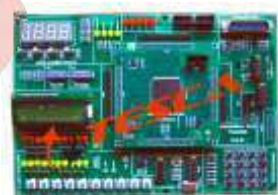

Order Code - 43540 is a FPGA/CPLD based VLSI Board for implementing various digital design for any Embedded applications.

Feature:

- 01. Supported Piggy Bag Modules:
 - 1.1 Order Code 43543 - Piggy Bag XILINX Xc9572 CPLD (optional)
 - 1.2. Order Code 43544 - Piggy Bag XILINX XC95108 CPLD (optional)
 - 1.3. Order Code 43541 - Piggy Bag XILINX SPARTAN XC3S50 FPGA(optional)
 - 1.4 Order Code 43542 - Piggy Bag XILINX SPARTAN XC3S400 FPGA(optional)
 - 1.5 Piggy Bag ALTRA EPIC6PQ240CB FPGA (optional)
- 02. Indicators
 - 2.1 16 input using 2 nos. Of 8 way DIP Switch with LED indication to indicate logic low and logic high
 - 2.2 16 LED for output indication.
- 03. Onboard Interfaces
 - 3.1 4 Digit Seven Segment Displays
 - 3.2 8 bit A/D convertor using ADC-0809.
 - 3.3 8 bit D/A convertor using DAC-0800.
 - 3.4 Stepper Motor Interface.
 - 3.5 Relay Interface.

- 3.6 Ps2 Interface.
- 3.7 RS-232 Interface.
- 3.8 VGA Interface.
- 3.9 16x1 Alphanumeric LCD Display.
- 3.10 5x4 Keys Keyboard Matrix.
- 04. ISP Programmer for Piggy Bag Module
- 05. Clock generator
 - 5.1 On-board 50MHz, 10MHz, 5MHz, 1MHz, 100KHz & 100Hz.
- 06. Power selection : On-board of 5V, 3.3V, 2.5V, 1.5V & 1.2V.
- 07. Power on Reset and configuration reset key
- 08. I/O expansions are provided through 26 pin FRC Connector for other application interface.
- 09. All IC's are mounted on IC Sockets.
- 10. Bare board Tested Glass Epoxy SMOBC PCB is used.
- 11. In-Built Power Supply of +5V/1.5A, ±12V/250mA
- 12. Attractive Wooden enclosures of Light weight Australian Pine Wood.
- 13. User's Manual with 25 sample experimental programs.

Optional:

- 01. Order Code 43543 - Piggy Bag XILINX XC9572 CPLD
- 02. Order Code 43544 - Piggy Bag XILINX XC95108 CPLD
- 03. Order Code 43541 - Piggy Bag XILINX SPARTAN XC3S50 FPGA
- 04. Order Code 43542 - Piggy Bag XILINX SPARTAN XC3S400 FPGA
- 05. Piggy Bag ALTRA EPIC6PQ240CB FPGA

Optional Interfaces :

- 01. Order Code 43546 - Interface Traffic Light for 43540, 43545
- 02. Order Code 43547 - Interface Stepper Motor for 43540, 43545
- 03. Order Code 43548 -Interface Real Time Clock for 43540, 43545
- 04. Order Code 43549 -Interface ADC0809 for 43540, 43545
- 05. Order Code 43550-Interface Dual DAC0800 for 43540, 43545

Universal VLSI (FPGA/ CPLD) Kit

Order Code - 43545



43545 is a FPGA/CPLD based VLSI Board for implementing various digital design for any Embedded applications.

Feature:

Supported Piggy Bag Modules :

- * Piggy Bag XILINX XC9572 CPLD (optional)
- * Piggy Bag XILINX XC95108 CPLD (optional)
- * Piggy Bag XILINX SPARTAN XC3S50 FPGA(optional)
- * Piggy Bag XILINX SPARTAN XC3S400 FPGA(optional)

Indicators

- * 16 input switch with LED indication to indicate logic low and logic high
- * 16 LED for output indication.

Onboard Interfaces

- * 4 Digit Seven Segment Displays
- * Ps2 Interface. (Optional)
- * RS-232 Interface. (Optional)
- * VGA Interface. (Optional)

ISP Programmer for Piggy Bag Module

- * 5Clock generator
- * On-board 50MHz, 10MHz, 5MHz, 1MHz, 100KHz & 100Hz
- 5Power on Reset and configuration reset key
- 5Power selection : On-board of 5V, 3.3V, 2.5V, 1.5V & 1.2V. t I/O expansions are provided through 26 pin FRC Connector for other application interface.
- All IC's are mounted on IC Sockets.
- Bare board Tested Glass Epoxy SMOBC PCB is used.
- In-Built Power Supply of +5V/1.5A, ±12V/250mA
- 5Attractive Wooden enclosures of Light weight Australian Pine Wood.
- User's Manual with 25 sample experimental programs.

Optional:

- * Piggy Bag XILINX Xc9572 CPLD
- * Piggy Bag XILINX XC95108 CPLD
- * Piggy Bag XILINX SPARTAN XC3S50 FPGA
- * Piggy Bag XILINX SPARTAN XC3S400 FPGA

8085 Microprocessor Trainer

Order Code - 43701



Specifications:

- 01. High performance 8085A CPU @ 3 MHz
- 02. 16 K powerful monitors FIRMWARE. Including all standard commands, codes, functions and utility subroutines besides Assembler and disassembler. 4K has been used for system firmware
- 03. 8 K user RAM 6264
- 04. Three 28 pin sockets provided for memory expansion up to a maximum of 56 K
- 05. Versatile Keyboard/Display controller using 8279 brought out on separate FRC connector
- 06. 46 parallel I/O lines, 22 from 8155 and 24 from 8255
- 07. Serial I/O through auto adjusting type RS-232 channel. This connector is conveniently brought on the rear using SID-SOD lines
- 08. Hex pad/Display Interface : 8279 Keyboard Display controller is used for Hex pad keys & Displays (6 Nos. of 7 segment Displays)
- 09. Three 16 bit Timer/Counter channels are available on-board 8253. These channels are available on a 10 pin FRC connector

10. On board 81C55-5 has a 2k-bit static RAM (256 bytes) with parallel I/O ports and a timer
11. In built Assembler when connected with PC
12. All address, data and control and hardware interrupt lines are brought out on a Pin FRC connector for system interfacing and expansion. All Study Cards are supported by this trainer kit
13. RAM sockets are provided with battery back up using 3.6V Ni-Cad battery
14. External Power Supply +5v 3Amp, +12v 1Amp, -12v 0.5Amp
15. Supplied in attractive wooden enclosure
16. Built-in audio cassette interface

8085 Microprocessor Trainer (LCD)

Order Code - 43702



Specifications:

01. High performance 8085A CPU @ 3 MHz
02. On board 40x2 LCD display
03. Operates on 5V, @1Amp. Optical built in or external power supply
04. 16 K powerful monitors FIRM WARE .Including all standard commands, codes, functions and utility subroutines with Assembler and dissembler.4K has been used for system firmware
05. 8 K user RAM 6264
06. Three 28 pin sockets provided for memory expansion up to a maximum of 56 K
07. Versatile Keyboard/Display controller using 8279 brought out on separate FRC connector
08. 46 parallel I/O lines, 22 from 8155 and 24 from 8255 are brought out on separate FRC connector
09. Serial I/O through auto adjusting type RS-232 channel. This connector is conveniently brought on the rear using SID-SOD lines
10. On board AT connector for 104 Key standards PC-compatible keyboard
11. Three 16 bit Timer/Counter channels are available on-board, using 8253. These channels are available on a 10 pin FRC connector
12. All address, data and control and hardware interrupt lines are brought out on a Pin FRC connector for system interfacing and expansion. All Study Cards are supported by this trainer kit
13. RAM sockets are provided with battery back up using 3.6V Ni-Cad battery
14. On board PIO power supply connector is provided for PIO interface
15. External Power Supply +5v 3Amp, +12v 1Amp, -12v 0.5Amp
16. Supplied in attractive Metal enclosure

8085 Microprocessor Trainer (LCD, USB)

Order Code - 43703



Specifications:

01. High performance 8085A CPU @ 3 MHz
02. On board 40 X 2 LCD display, with optional 16 X 2 or 16 X 4 instead of 40 X 2 LCD
03. Operates on 5V, @1Amp. external power supply On Boards 5v Adapter Jack
04. 16 K powerful monitor FIRMWARE. Including all standard commands, codes, functions and utility subroutines with Assembler and dissembler. 4K has been used for system firmware
05. 32 K user RAM 62256
06. Three 28 pin sockets provided for memory expansion up to a maximum of 56 K
07. Versatile Keyboard / Display controller using 8279 brought out on separate FRC connector
08. 46 parallel I/O lines, 22 from 8155 and 24 from 8255 are brought out on separate FRC connector
09. On Board USB interface hardware
10. Serial I/O through auto adjusting type RS-232 channel. This connector is conveniently brought on the rear using SID-SOD lines or Jumper selectable USB connector
11. On board PS2 connector for 104 Key standard PC-compatible keyboard
12. Three 16 bit Timer / Counter channels are available on-board, using 8253. These Channels are available on a 10 pin FRC connector
13. All address, data and control and hardware interrupt lines are brought out on a 50 pin FRC connector for system interfacing and expansion. All study Cards are supported by this trainer kit
14. RAM sockets are provided with battery back up using 3.6V Ni-Cad battery
15. On board power supply screw terminal is provided for PIO interface
16. External Power Supply +5v 3Amp, +12v 1Amp, -12v 0.5Amp
17. Supplied in attractive wooden enclosure

High Performance 8085 Microprocessor Trainer

Order Code - 43704



Specifications:

01. High performance 8085A CPU @ 3 MHz
02. 16 K powerful monitors FIRMWARE expandable to 32K
03. 64 K user RAM with battery back up using 3.6V Ni-Cad battery
04. Expanded RAM accessible using bank switching technique
05. Write protect facility for RAM
06. Versatile Keyboard/Display controller using 8279 24 highly reliable dual function keys. 6 digit seven segment LED display
07. 48 parallel I/O lines available through two 8255 chips
08. Serial I/O through 82C51A-2 USART, with on-board level shifters 1488, 1489. Programmable communication parameters
09. Built-in audio cassette interface
10. 3 channels of 16 bit timer/counters from 8253
11. Powerful 8085 interrupt capabilities

12. On-board EPROM programmer with ZIP socket for programming 2716 to 27512 EPROM's and various EPROM's
13. Normal and intelligent programming modes
14. On board ADC, DAC, opto-isolator, reed relay and miniature speaker
15. On-board logic probe
16. Single stepping, break pointing and machine cycle single stepping facility
17. Monitor functions can be called through software interrupts
18. Large collection of application software provided
19. All address, data and control and hardware interrupt lines are brought out on a 50 pin FRC connector for system interfacing and expansion. All Study Cards are supported by this trainer kit
20. External Power Supply +5v 3Amp, +12v 1Amp, -12v 0.5Amp(SMPS-03)
21. Supplied in attractive wooden enclosure

Z80A Based Microprocessor Trainer

Order Code - 43705



Specifications:

01. High Performance Z80A CPU @ 4 MHz
02. 8 K Powerful Monitor FIRMWARE in 2764 Includes all standard Commands, Codes, Functions & Utility subroutines
03. 8 K user RAM
04. Memory expansion capability up to 40 K
05. Versatile Keyboard/Display controller using 8279
06. 48 Parallel I/O lines from two 8255 chips
07. Serial I/O through RS232 channel
08. Built-in audio cassette interface
09. 4 programmable counter timer channels from Z 80 CTC
10. Powerful Z80A interrupt capabilities
11. On-board EPROM programmer with ZIF socket for 2716 to 27512 EPROMs
12. 6 digit seven segment LED display
13. Highly reliable multi-function keypad with 24 keys
14. All address data and control lines buffered and brought out on 50 pin FRC connector
15. Supplied in a strong and attractive lightweight wooden case
16. Power supply : Specially designed 230 VAC Power supply

8086 Microprocessor Trainer

Order Code - 43706



Specifications:

01. CPU is Based on 16 bit Intel 8086 High Performance CPU Operating at 8 MHz
02. An Optical socket is provided for 8087-2 NDP (co-processor)

03. 8284 clock generator & 8288 bus controller
04. Powerful Monitor Firmware in two 27256 EPROMs (64KB) organized as 16 bit words. Monitor EPROMs expandable to 128 KB using two 27512 EPROMs
05. 64 KB Static RAM in two 62256 RAMs organized as 16 bit words with battery back-up for data retention.
06. 3.6 V Ni-Cad battery back-up circuit for static RAMs
07. Hex pad/Display Interface through 8279 Keyboard Display controller
08. On board 8254 Time/Counter chip. Out of 3 Channels of Timer/Counter Two Channels are totally available to the user through a 7 pin relimate Connector
09. 48 TTL I/O Lines using two 8255 PPI chips and All Signals Terminated on Two 26 pin FRC Connectors
10. Printer Interface Provided through another 26 pin FRC Connector
11. Interface: RS232 Port is provided for Serial Interface. 8251 USART along with 1488, 1489 driver Chip Provides Necessary signals brought out on a 9 bit D type Connector
12. Baud Rates from 300 to 9600 can be selected through Software
13. Interrupt Controller: The 8259 Interrupt Controller Provides 8 Prioritized interrupt Levels
14. Detachable Hex Keypad & Display PCB
15. All 8086 bus Signals terminated on 50 and 20 Pin FRC Connector
16. Peripheral study cards can be Interfaced through 50 Pin FRC bus
17. PIO Cards can be Interfaced through 26 Pin FRC connector Two Modes of Operation
Modes of Operation:
18. Attractive Lightweight wooden enclosure
19. Switch Mode Power Supply +5v 3Amp, +12v 1Amp, -12v 0.5Amp M 7 USER'S ANUAL 43 06
- i. Monitor Mode : User Interaction through 28 Key Hex keypad and 8 Digit seven segment displays
- ii. Serial Mode : Serial mode Through RS-232 Serial Port for Use with a Terminal
10. Printer Interface Provided through another 26 pin FRC Connector
11. Interface: RS232 Port is provided for Serial Interface. 8251 USART along with 1488, 1489 driver Chip Provides Necessary signals brought out on a 9 bit D type Connector
12. Baud Rates from 300 to 9600 can be selected through Software
13. Interrupt Controller: The 8259 Interrupt Controller Provides 8 Prioritized interrupt Levels
14. Detachable Hex Keypad & Display PCB
15. All 8086 bus Signals terminated on 50 and 20 Pin FRC Connector
16. Peripheral study cards can be Interfaced through 50 Pin FRC bus
17. PIO Cards can be Interfaced through 26 Pin FRC connector Two Modes of Operation
Modes of Operation:
i. Monitor Mode : User Interaction through 28 Key Hex keypad and 8 Digit seven segment displays
- ii. Serial Mode : Serial mode Through RS-232 Serial Port for Use with a Terminal
18. Attractive Lightweight wooden enclosure
19. Switch Mode Power Supply +5v 3Amp, +12v 1Amp, -12v 0.5Amp M 7 USER'S ANUAL 43 06

8086 Microprocessor Trainer (LCD, USB)

Order Code - 43707



Specifications:

01. CPU is Based on Intel 8086 High Performance CPU Operating at 8 MHz Speed
02. Numeric Co-Processor : An Optional socket is provided for 8087-2 NDP
03. 8284 A Clock Generator
04. 8288A bus Controller
05. Memory: 64 KB Powerful monitor firmware, expandable up to 128KB
06. 64KB Static RAM with 3.6 V NI-cad battery backup
07. 40 characters X 2 lines LCD Display
08. IBM Compatible ASCII Keyboard
09. On-board 8254 time/counter chip
10. Printer Interface Provided Through another 26 Pin FRC Connectors
11. RS232 compatible serial port using 8251, signals Terminated on 9 pin D-Type male connector
12. On board 8259 PIC
13. On board USB connector
14. All address, data and control and hardware interrupt lines are brought out on a 50 pin FRC connector for system interfacing and expansion. All Study Cards are supported by this trainer kit
15. Assembly language environment with inbuilt assembler & dis-assembler
16. Terminal emulation software included
17. Attractive wooden enclosure and operational manuals
18. Switch Mode Power Supply +5v 3Amp, +12v 1Amp, -12v 0.5Amp

8086 Microprocessor Trainer (LCD)

Order Code - 43708



Specifications:

01. CPU is Based on Intel 8086 High Performance CPU operating at 8 MHz Speed
02. Numeric Co-Processor : An optional socket is provided for 8087-2 NDP
03. 8284 A Clock Generator
04. 8288A bus Controller
05. Memory: 64 KB Powerful monitor firmware, expandable up to 128KB
06. 64KB Static RAM with 3.6 V NI-cad battery backup
07. 40 characters x 2 lines LCD Display
08. IBM Compatible ASCII Keyboard
09. On-board 8254 time/counter chip
10. Printer Interface Provided Through another 26 Pin FRC Connectors
11. RS232 compatible serial port using 8251, signals Terminated on 9 pin D-Type male connector

12. On Board 8259 PIC
13. All address, data and control and hardware interrupt lines are brought out on a 50 pin FRC connector for system interfacing and expansion. All Study Cards are supported by this trainer kit
14. Assembly language environment with inbuilt assembler & dis-assembler
15. Terminal emulation software included
16. Attractive Metallic enclosure and Operational Manuals
17. Inbuilt Specially Designed 230v AC Input switch Mode Power Supply

8051 Microcontroller Trainer

Order Code - 43710



Specifications:

01. 8bit 8031/8051 microcontroller @ 10MHz
02. System Monitor ROM is 8K bytes
03. System break point RAM 32K bytes
04. User RAM 8k bytes supplied (62256); provision for up to 32Kbytes (62256)
05. User ROM is 8Kbytes
06. Onboard Battery Backup for the user RAM
07. On Board Peripheral chips -8155 RAM. I/O Timer, 8255 Programmable Peripheral Interface, 8253 Programmable timer Counter, 8251 USART
08. Port accessible to user
 - a. Two 8 bit Parallel ports from 8155
 - b. Three 8 bit Parallel Ports from 8255
 - c. One 8 bit on-chip Parallel port P1
 - d. One on-chip Serial Port of 8031
09. All address, data control and 8031 port P1 and P3 lines brought out on a 50 pin FRC connector for system expansion
10. Operates with a serial CRT Terminal or with IBM Compatible PC Having terminal emulation software
11. Modes Of Operation:
 - a. Interrogation mode: for Interactive dialog with the system
 - b. Assembler mode: for Programming directly in assembly language
 - c. Continuation mode: for Setting RAM contents
 - d. Single step mode: for single stepping, break pointing and debugging
12. User Programs can be Downloaded or Uploaded in Intel Hex Format from the PC
13. Power Supply: Specially Designed 230VAC Power Supply

8031/ 51 Microprocessor Trainer (LCD)

Order Code - 43711



Specifications:

01. Intel 80C51 Microcontroller Operating at 12MHz

02. 32KB on board Program Memory
03. 12KB Battery backed up user Program Memory
04. 16KB Battery backed up User Data Memory
05. 40 characters x 2 Lines LCD Display
06. IBM Compatible ASCII Keyboard
07. 8253 Timer/counter chip. Two Channels available to user
08. 48 TTL I/O Lines using two 8255 PPI chips and all signal terminated on two 26 pin FRC (PIO card compatible)
09. RS232 compatible Serial port using 8250, signals terminated on 9 pin D-type connector
10. Study card support on 50 pin FRC connector
11. Inbuilt specially designed 230v AC input Switch mode power supply
12. Powerful monitor software with standard commands like move, fill, display/modify memory/ registers, execute program, upload / download etc
13. Single line assembler / dis-assembler
14. Serial mode for using the kit with terminal
15. Attractive Metallic enclosure and Operational Manuals

8031/ 51 Microprocessor Trainer (LCD, USB)

Order Code - 43712



Specifications:

01. Intel 80C51 Microcontroller Operating at 12MHz
02. 32KB Onboard Program Memory
03. 12KB Battery backed up user Program
04. 16KB Battery backed up User Data Memory
05. 40 characters x 2 Lines LCD Display
06. IBM Compatible ASCII Keyboard
07. 8253 Timer/counter chip. Two Channels available to user
08. 48 TTL I/O Lines using two 8255 PPI chips and all signal terminated on two 26 pin FRC (PIO card compatible)
09. RS232 compatible Serial port using 8250, signals terminated on 9 pin D-type connector
10. On board USB connector
11. Study card support on 50 pin FRC connector
12. Powerful monitor software with standard commands like move, fill, display/modify memory/ registers, execute program, upload / download etc
13. Single line assembler / dis-assembler
14. Serial mode for using the kit with terminal
15. Attractive wooden enclosure and Operational Manuals
16. External power supply SMPS-03

80C196 Development Kit

Order Code - 43713



The 80C196 KB Microcontroller chip chosen for our 43713 training system, is a high speed Microcontroller operating @12MHz, with RAM but no ROM. In addition, you have 16 KB battery backed up RAM (expandable to 256KB) and 16KB ROM (expandable to 256 KB). The Microcontroller is compatible with 83C 196 & 87 C 196 family, hence learner can easily put it into their applications. This Microcontroller has special capabilities of a Byte Register File (256 Byte additional RAM in 80C 196 KC), a 10 Bit A/D Converter with Sample/ Hold, a 16-Bit Watchdog Timer and High Speed I/O System. It has 28 Interrupt Sources / 16 Vectors, 8 Bits I/O Ports with one PWM output. The firmware continues the same simplicity and variety. It's user friendly with a powerful set of command through 'HEX Key Pad' and 'Serial Mode' In one word. Also provided with this training system is a full set of documentation. Block diagrams, component layout and connector details are totally transparent.

Specifications:

01. 16KB RAM (2 x 6264) Expandable up to 256 KB (2x628128), fully battery backed up
02. 16 KB EPROM (2 x 2764) Expandable up to 256KB (2 x 27C010 or equivalents)
03. Full Duplex RS232 Serial Port
04. 48 PIO Lines using two 8255, shared with the printer port
05. Centronics parallel port via 8255
06. 3 channel Timer / counter using 8254
07. Real Time Clock using DS 1287 / 48T87 or equivalents with built in battery backup
08. Onboard Hex Keyboard / Display Controller
09. Hex Keypad Display Module with 28 Keys and 8 seven segment LED Display
10. All Signal Brought on to Two 96 pin EURO Connectors
11. Monitor Features
 - a. Single Stepping/auto stepping
 - b. Memory Read/ Modify/fill/copy
 - c. Register Read / Modify
 - d. Set/Clear Breakpoints
 - e. Run/execute
 - f. High Speed I/O Codes
 - g. Read ADC, Read / set clock, print Buffer, codes
 - h. Upload / Download codes via serial port bank switching
 - i. Comprehensive 'HELP'
12. Power Supply: Specially Designed 230VAC Power Supply
13. Enclosed in a wooden box

8031/ 8051 Based Evaluation Board

Order Code - 43714



Features & Specifications:

- * Entry level Evaluation board for 8031/8051 MCU's.
- * High Performance 89V51RD2 MCU @ 12 MHz.
- * 80C51 Core MCU
- * 5 V operating voltage from 0 MHz to 40 MHz
- * 64 kB of On-Chip Flash User Code Memory with ISP and IAP

- * 256B On Chip RAM Memory
- * Supports 12-clock (default) or 6-clock mode selection via software or ISP
- * SPI and enhanced UART
- * PCA with PWM and capture/compare functions
- * Four 8-bit I/O ports with three high-current port 1 pins (16 mA each)
- * Three 16-bit timers/counters
- * Programmable watchdog timer
- * Eight interrupt sources with four priority levels
- * Second DPTR register
- * Low EMI mode (ALE inhibit)
- * TTL- and CMOS-compatible logic level
- * Brownout detection
- * Low power modes : Power-down mode with external interrupt wake-up & Idle mode
- * On Board USB interface hardware
- * On Board Prototype area for user Development
- * Serial Port is provided for Program Downloading
- * RS232 Port is provided for Serial Interface
- * All 8031/51 bus Signals & PORT I/O Lines are brought out on FRC Connectors
- * A new series of Interface cards have been specially designed for 43714 to suit curriculum requirements
- * Program Downloading using Flash Magic Software
- * Onboard Jack for use with 5V adapter
- * Switch Mode Power Supply: +5v 3A, +12v 1 A, -12v 0.5A
- * Supplied in attractive Wooden enclosure
- * Documentation includes User Manual with details
- * Cable & connector set available for interfacing

PIC Based Evaluation Board

Order Code - 43715



43715 Training & development cum Evaluation kit

MCU

- * Memory : 8K-32K FLASH – Program
- * Clock : 8MHz crystal, Max 20 MHZ

Features & Specifications:

- * Power LED & UART communication LEDs (RX.TX)
- * FTDI chip
- * USB UART & RS232 Connector
- * 40pin-DIP Socket
- * 8 Nos. SMD RED GREEN LEDs
- * 2 Nos. Digital Input (DIP Switch)
- * 4 Nos. Push Button
- * Analog Input (Potentiometer)
- * Temperature Sensor (LM35)
- * SPDT Relay & DC Piezo Electric Buzzer
- * USART (RS232)
- * USB 2.0 Enabled Programmer
- * Interrupts Study
- * Power supply select
- * Power adapter connector
- * BOX type 10pin Male headers
- * Reset button mikroProg™ connector
- * Crystal oscillator

Benefits:

- * Evaluate Real Time Applications
- * Supports Embedded C, ASM
- * ISP Programming | SPI | I2C | CAN
- * 26pin FRC Facility to interface external devices

Package Contains:

- * Supplied in attractive wooden / Acrylic / Metallic enclosure
- * 43715 (Size : 127.00 x 101.60 mm)
- * User Guide and Schematic
- * USB & Serial Cable RS232
- * MPLAB XIDE C18 Compiler

For More Details Visit our New Website www.tesca.in

- Order Code - 43725 - 8155 Study Card for 43701 to 43703, 43706 to 43708, 43711 to 43712
- Order Code - 43727 - 8255 Study Card for 43701 to 43703, 43706 to 43708, 43711 to 43712
- Order Code - 43728 - 8253 Study Card for 43701 to 43703, 43706 to 43708, 43711 to 43712
- Order Code - 43729 - 8251 Study Card for 43701 to 43703, 43706 to 43708, 43711 to 43712
- Order Code - 43731 - 8259 Study Card for 43701 to 43703, 43706 to 43708, 43711 to 43712
- Order Code - 43732 - 8279 Study Card for 43701 to 43703, 43706 to 43708, 43711 to 43712
- Order Code - 43733 - 8237/8257 DMA Control Study Card for 43701 to 43703, 43706 to 43708, 43711 to 43712
- Order Code - 43734 - Traffic Control Study Card for 43701 to 43703, 43706 to 43708, 43711 to 43712
- Order Code - 43735 - DC Motor Control Study Card for 43701 to 43703, 43706 to 43708, 43711 to 43712
- Order Code - 43736 - Thumbwheel control Study Card for 43701 to 43703, 43706 to 43708, 43711 to 43712
- Order Code - 43737 - 8 bit, 1 channel A to D Converter Study Card for 43701 to 43703, 43706 to 43708, 43711 to 43712
- Order Code - 43738 - 8 bit, 8 channel A to D Converter Study Card for 43701 to 43703, 43706 to 43708, 43711 to 43712
- Order Code - 43740 - D to A Converter Study Card for 43701 to 43703, 43706 to 43708, 43711 to 43712
- Order Code - 43741 - Display Interface Study Card for 43701 to 43703, 43706 to 43708, 43711 to 43712
- Order Code - 43742 - Elevator Simulator Study Card for 43701 to 43703, 43706 to 43708, 43711 to 43712
- Order Code - 43743 - Keyboard Simulator Study Card for 43701 to 43703,

- 43706 to 43708, 43711 to 43712
- Order Code - 43744 - Logic Controller Study Card for 43701 to 43703, 43706 to 43708, 43711 to 43712
- Order Code - 43746 - Relay, Opto-isolator study card for 43701 to 43703, 43706 to 43708, 43711 to 43712
- Order Code - 43747 - Stepper Motor Control Study Card for 43701 to 43703, 43706 to 43708, 43711 to 43712
- Order Code - 43748 - 12V, 2KG CM2 for STP-PIO Card for 43701 to 43703, 43706 to 43708, 43711 to 43712
- Order Code - 43749 - Temperature control study card for 43701 to 43703, 43706 to 43708, 43711 to 43712
- Order Code - 43750 - Traffic control study card for 2 squares for 43701 to 43703, 43706 to 43708, 43711 to 43712

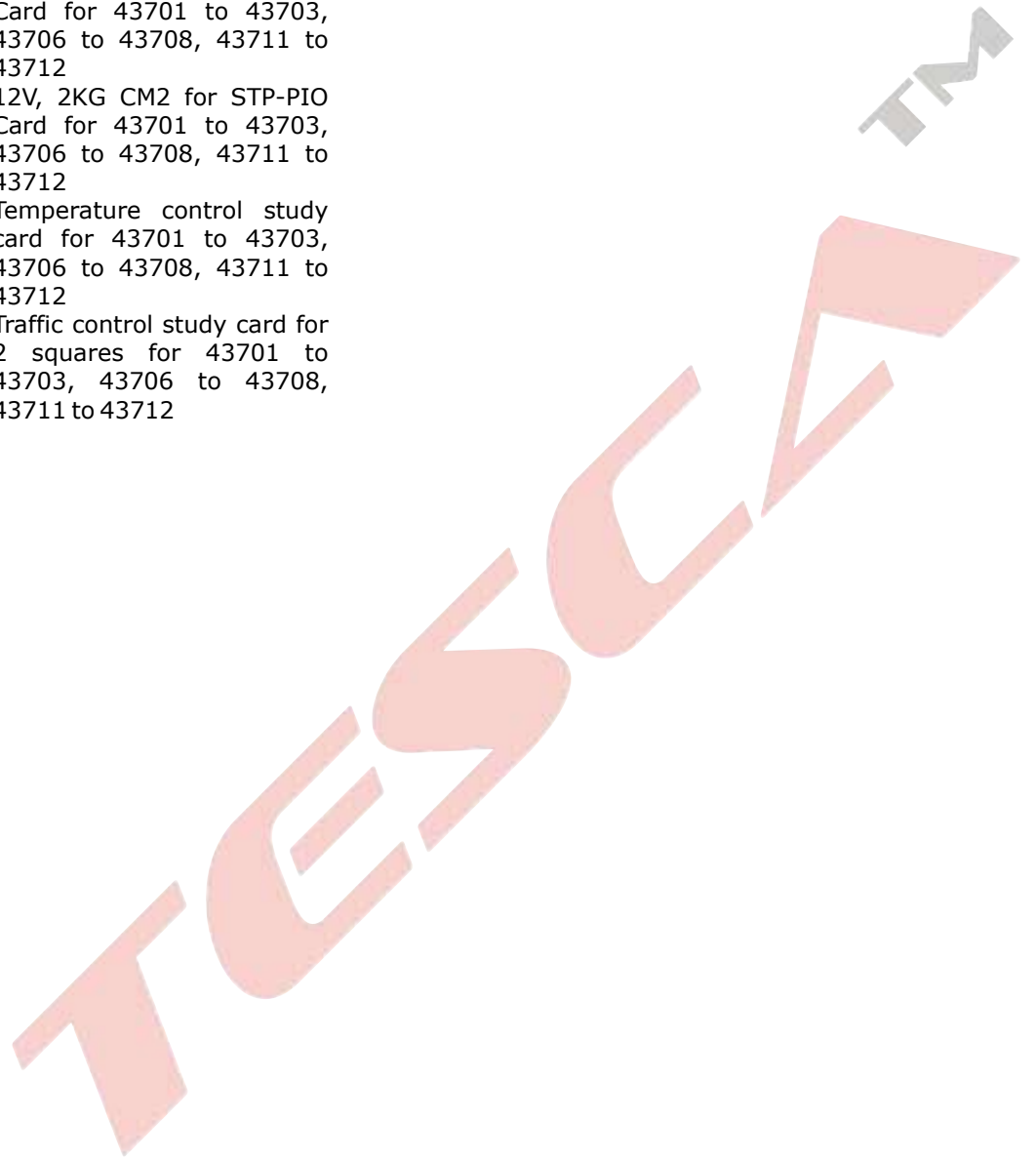

Fibre-Optic Simplex Analogue Transceiver Trainer

Order Code - 28501



Fibre-Optic Simplex Analogue Transceiver Trainer has been designed specifically for the study of a typical linear intensity modulation system for analogue signal transmission.

Practical experience on this board carries great educative value for Science & Engineering Students.

Object:

To study ac characteristics of a Linear Intensity Modulation system :

01. Gain characteristics of a fibre optic Linear Intensity Modulation System $V_{in} (ac)$ Vs $V_o (ac)$ for fixed carrier power P_o and signal frequency,
02. Frequency Response of ac fibre-Optic Linear Intensity Modulation System. $V_{out} (ac)$ Vs f_o at fixed carrier power P_o and $V_{in} (ac)$.
03. Gain-Band width Product of a fibre Optic Linear Intensity Modulation Receiver. Gain Vs Bandwidth for fixed V_{in} .

Features:

The board consists of the following built-in parts:

01. IC Regulated D.C. Power Supply.
 02. Fibre-Optic Transmitter
 03. Fibre-Optic Receiver
 04. Potentiometer to vary the current of LED in Transmitter and Photo transistor in receiver.
 05. Adequate no of other electronic components.
 06. Mains ON/OFF switch, Fuse and Jewel light.
- * The unit is operative on 230V $\pm 10\%$ at 50Hz A.C. Mains.
 - * Adequate no. of patch cords stackable 4mm spring loaded plug length $\frac{1}{2}$ metre.
 - * Good Quality, reliable terminal/sockets are provided at appropriate places on panel for connections / observation of waveforms.
 - * Strongly supported by detailed Operating Instructions, giving details of Object, Theory, Design procedures, Report Suggestions and Book References.

Other Apparatus Required:

01. AF/RF Generator 10Hz to 1MHz Order Code - 16902
02. Digital Multimeter Order Code - 16901
03. Cathode Ray Oscilloscope 20MHz

Fibre-Optic Simplex Digital Transceiver Trainer

Order Code - 28502



Fibre-Optic Simplex Digital Transceiver Trainer has been designed specifically for the study of characteristics & propagation delay in digital fibre optic

transmission systems.

Practical experience on this board carries great educative value for science & engineering students.

Object:

01. Design & study of a fibre-optic Digital link.
02. Study of Rise-Time and Fall-Time distortions
03. Study of Propagation Delay.

Features:

The board consists of the following built-in parts:

01. Two isolated IC Regulated D.C. Power Suppliers.
 02. Timer IC for Square Wave Frequency Generator.
 03. Three potentiometers to vary R_{TH} (Threshold Resistance), R_{IN} (Input Resistance) and frequency.
 04. Fibre Optic Digital Transmitter @ 660nm
 05. Fibre Optic Digital Receiver.
 06. Adequate no of other electronic components.
- * The unit is operative on 230V $\pm 10\%$ at 50Hz A.C. Mains.
 - * Adequate no. of patch cords stackable 4mm spring loaded plug length $\frac{1}{2}$ metre.
 - * Good Quality, reliable terminal/sockets are provided at appropriate places on panel for connections / observation of waveforms.
 - * Strongly supported by detailed Operating Instructions, giving details of Object, Theory, Design procedures, Report Suggestions and Book References.

Other Apparatus Required:

01. Digital Multimeter Order Code - 16901
02. Cathode Ray Oscilloscope 20MHz

Advanced Fibre-Optic Analogue Transceiver Trainer

Order Code - 28503



Fibre-Optic Simplex Analogue Transceiver Trainer has been designed specifically for the study of a typical linear intensity modulation system for analogue signal transmission.

Practical experience on this Trainer carries great educative value for Science & Engineering Students.

Object:

01. To determine the Numerical Aperature of optical fibre.
 02. Losses in Optical Fibres at 660nm and 850nm and other cables.
 03. Study of E/O Characteristic of Fibre Optic 660nm and 850nm.
 04. Study of O/E Characteristic of Fibre Optic photo transistor.
 05. Design and study of a linear Fibre Optic Intensity Modulation system for analog transmission :
- * Gain characteristics of a Fibre Optic Linear Intensity Modulation System.
 - * Frequency Response of a Fibre Optic Linear Intensity Modulation System.

- * Waveform distortion in a Fibre Optic Linear Intensity Modulation System.
- * Gain-Band width product of a fibre optic linear intensity Modulation System.

Features:

The trainer consists of the following built-in parts:

01. IC regulated D.C. power supply.
02. Fibre-Optic Analogue Transmitter @ 660nm
03. Fibre-Optic Analogue Transmitter @ 850nm
04. Fibre-Optic Receiver.
05. One-metre PMMA Fibre patch cord.
- 06 Five-metre PMMA Fibre patch cord.
07. In-line SMA adaptor.
08. Two potentiometer to vary forward current of LED in Transmitter & current of photo transistor in receiver.
09. SPDT switch for selecting wavelengths 660nm and 850nm.
10. NA JIG with scale marked on it to measure length.
11. Mandrel.
12. NA measuring Scale to measure width of Fibre Optic's LED.
13. Adequate no of other electronic componets.
14. Mains ON/OFF switch, Fuse and Jewel light.
- * The unit is operative on 230V ±10% at 50Hz A.C. Mains.
- * Adequate no. of patch cords stackable 4mm spring loaded plug length ½ metre.
- * Good Quality, reliable terminal/sockets are provided at appropriate places on panel for connections / observation of waveforms.
- * Strongly supported by detailed Operating Instructions, giving details of Object, Theory, Design procedures, Report Suggestions and Book References.

Other Apparatus Required

01. AF/RF Generator 10Hz to 1MHz Order Code - 16902
02. Digital Fibre-Optic Power meter Order Code - 28509
03. Digital Multimeter Order Code - 16901
04. Cathode Ray Oscilloscope 20MHz

Advanced Fibre-Optic Digital Transceiver Trainer

Order Code - 28504



Fibre-Optic Digital Transceiver Trainer has been designed specifically for the study of encoding methods used in digital fibre Optic. Transmission system. Practical experience on this board carries great educative value for science & eng. Students.

Object:

01. Design and study of a Fibre-optic digital link.
02. Study of rise-time and fall-time distortions
03. Study of propagation delay.
04. Encoding methods for fibre-optic digital transmission
- * Base band or Non Return to Zero (NRZ)

Transmission.

- * Return to Zero coding (RZ)
- * Non Return to zero inverted coding (NRZI)
- * Biphase Coding
- * Manchester Coding.

Features:

The board consists of the following built-in parts:

01. Two Isolated IC regulated D.C. power supplies.
02. Fibre-Optic digital transmitter @ 660nm
03. Fibre-Optic digital receiver.
04. Two potentiometers to vary, RIN (input resistance) of receiver and RTH (Threshold resistance) of receiver.
05. Encoder IC
06. Decoder IC
07. Two crystals
08. Two reset switches resetting encoder and decoder.
09. Adequate no of other electronic component.
10. Mains ON/OFF switch, Fuse and Jewel light.
- * The unit is operative on 230V ±10% at 50Hz A.C. Mains.
- * Adequate no. of patch cords stackable 4mm spring loaded plug length ½ metre.
- * Good Quality, reliable terminal/sockets are provided at appropriate places on panel for connections / observation of waveforms.
- * Strongly supported by detailed Operating Instructions, giving details of Object, Theory, Design procedures, Report Suggestions and Book References.

Other Apparatus Required:

01. Cathode Ray Oscilloscope 20MHz.

Fibre-Optic Trainer for Numerical Aperture and Fibre Loss Measurement

Order Code - 28505



Fibre-OpticTrainer for Numerical Aperture and Fibre Loss Measurement has been designed specifically for the study of Numerical Aperture and Fibre Loss Measurement.

Practical experience on this Trainer carries great educative value for Science & Engineering Students.

Object:

Study of :

01. Fibre Optic Transmitter and Receiver.
02. Numerical Aperture of PMMA Fibre.
03. Loss in 1 Mtr / 5 Mtr. PMMA Patch Chords.
04. Electrical - Optical Converter Characteristics.
05. Optical to Electrical Converter Characteristics.
06. Intensity Modulation System.

Features:

The trainer consists of the following built-in parts:

01. IC regulated D.C. power supply.
02. Fibre-Optic Analogue Transmitter @ 660nm
03. Fibre-Optic Analogue Transmitter @ 850nm
04. Fibre-Optic Receiver.
05. One-metre PMMA Fibre patch cord.

06. Five-metre PMMA Fibre patch cord.
07. In-line SMA adaptor.
08. Two potentiometer to vary forward current of LED in Transmitter & current of phototransistor in receiver.
09. SPDT switch for selecting wavelengths 660nm and 850nm.
10. NA JIG with scale marked on it to measure length.
11. Mandrel.
12. NA measuring Scale to measure width of Fibre Optic's LED.
13. Adequate no of other electronic componets.
14. Mains ON/OFF switch, Fuse and Jewel light.
- * The unit is operative on 230V \pm 10% at 50Hz A.C. Mains.
- * Adequate no. of patch cords stackable 4mm spring loaded plug length ½ metre.
- * Good Quality, reliable terminal/sockets are provided at appropriate places on panel for connections / observation of waveforms.
- * Strongly supported by detailed Operating Instructions, giving details of Object, Theory, Design procedures, Report Suggestions and Book References.

Other Apparatus Required:

01. AF/RF Generator 10Hz to 1MHz Order Code - 16902
02. Digital Fibre-Optic Power meter Order Code - 28509
03. Digital Multimeter Order Code - 16901
04. Cathode Ray Oscilloscope 20MHz.

Fibre-Optic Voice Transmitter& Receiver Trainer

Order Code - 28506



Fibre-Optic Voice Transmitter and Receiver Trainer has been designed specifically to learn mysteries and science of Fibre Optics. In a way it is a Lab-Optics Voice Link Trainer

Practical experience on this Trainer carries great educative value for Science & Engineering Students.

Experiments:

01. Study of fibre - optic transmitter and receiver for audio signal transmission.
02. Study of fibre - optic transmitter and receiver for voice signal transmission.

Features:

The trainer consists of the following built-in parts:

01. Fibre-Optic transmitter @ 660nm.
02. Audio Amplifier circuit.
03. 12V & 6V DC at 200mA, IC Regulated power supply internally connected.
04. One mike connector.
05. Potentiometer to vary the current of LED.
06. Fibre - optic photo transistor.
07. Detector circuit with speaker of 8 ohms.
08. Mains ON/OFF, Fuse and jewel Light.
09. A mike to transmit voice.

10. One meter and five-meter PMMA patch cords with in - line adaptor.
11. The units are operative on 230V \pm 10% at 50Hz A.C. Mains.
- * Adequate no. of patch cords stackable 4mm spring loaded plug length ½ metre.
- * Good Quality, reliable terminal/sockets are provided at appropriate places on panel for connections / observation of waveforms.
- * Strongly supported by detailed Operating Instructions, giving details of Object, Theory, Design procedures, Report Suggestions and Book References.

Other Apparatus Required:

01. Cathode Ray Oscilloscope 20MHz.
02. AF/RF Generator 10Hz to 1 MHz Order Code - 16902

Laser Diode Intensity Modulation and Demodulation Trainer

Order Code - 28507



Laser Diode Intensity Modulation and Demodulation Trainer has been developed to conduct studies on laser Diode, optical fibres and optical communication methods, by signal transmission.

Practical experience on this Trainer carries great educative value for Science & Engineering Students.

Experiments:

01. Characterisation of a Laser Diode.
 - * Optical Power (Po) of a Laser Diode Vs Laser Diode Forward current (I). F
 - * Monitor Photodiode Current (I) Vs Laser Optical Power Output (Po). M
02. Study of Automatic Current Control (ACC) or Automatic Power Control (APC) Modes of Operation
 - * Comparison of ACC and APC Modes of Operation.
03. Design and Evaluation of an Laser Diode (LD) Analog I System M
 - * Vo Vs Vin at Specified Optical Carrier Power Levels, Po.
 - * Determination of Vin (max) at Specified Po for Distortion-free Vo.
04. Design and Evaluation of Laser Diode LD Digital Transmission System
 - * Risetime and Falltime Pulsetwidth Distortions and Determination of Propogation Delay.
05. Transmission of Laser Through an Optical Fibre
 - * To measure loss in dB of Step-index Multimode plastic Fibre Patchcord.
 - * To measure loss in dB of Graded-Index, Multimode Glass Fibre Patchcord.
 - * To measure loss in dB of Two Patchcords connected by the in-line adaptor.
06. Laser Free Space Communication
 - * Analogue Free Space Communication System.
 - * Digital Free Space Communication System.
07. Determination of Numerical Aperture of PMMA

Fibre Cable

Features:

The trainer consists of the following built-in parts:

01. Laser Diode Transmitter unit having following built-in parts :
 - 1.1 Laser Diode transmitter module.
 - 1.2 6V DC at 100mA, IC Regulated Power Supply internally connected.
 - 1.3 SPDT switch to select Automatic Current Control (ACC) or Automatic Power Control (APC).
 - 1.4 Potentiometer to set power output.
 - 1.5 Adequate no of other electronic components.
 - 1.6 Mains ON/OFF switch, Fuse and Jewel light.
02. Laser Diode Receiver unit having following built-in parts :
 - 2.1 Laser Diode Receiver Module.
 - 2.2 PIN Diode for measuring power of Laser Diode.
 - 2.3 Potentiometer to set voltage output.
 - 2.4 Adequate no. of other electronic components.
 - 2.5 6V DC at 100mA, IC Regulated Power Supply internally connected.
03. Two-metres PMMA Plastic Fibre patchcord -----1).
04. Two-metres GI/mm Glass Fibre patchcord -----2).
05. In-line SMA adaptor.
06. Numerical Aperture measurement Jig.
07. Mandrel.
- * The units are operative on 230V \pm 10% at 50Hz A.C. Mains.
- * Adequate no. of patch cords stackable 4mm spring loaded plug length $\frac{1}{2}$ metre.
- * Good Quality, reliable terminal/sockets are provided at appropriate places on panel for connections / observation of waveforms.
- * Strongly supported by detailed Operating Instructions, giving details of Object, Theory, Design procedures, Report Suggestions and Book References.

Other Apparatus Required:

01. AF/RF Generator 10Hz to 1 MHz Order Code - 16902
02. Three Digital Multimeter Order Code - 16901
03. Cathode Ray Oscilloscope 20MHz

Physics of Fiber Optics Trainer

Order Code - 28508



PHYSICS OF FIBER OPTICS TRAINER is designed to learn basic physics of fiber optics including fiber end preparation. Students can also study the construction of transmitter & receiver to form analog & digital link. Ample number of experiments can be performed with this kit by referring to the exhaustive manuals provided with the kit.

Features:

01. On-board Function Generator.
02. Transmitter : 1 No.
03. Receiver : 2 Nos

04. Fiber Optic Analog Link.
05. Fiber Optic Digital Link.
06. Signal strength indicator.

Technical Specifications:

01. Transmitter : 1 No. LED. Peak wavelength of emission 635 nm Red visible.
02. Receiver : 2 Nos. silicon photo detectors
03. Modulation : Intensity modulation.
04. Driver Circuit : Analog and digital configuration for 635 nm LED.
05. Analog Bandwidth : 35KHz.
06. Digital Bandwidth : 50KHz.
07. On-Board Function Generator :
08. Sine Wave & TTL Square Wave :
09. Frequency Range : 1Hz to 10Hz, 10Hz to 100Hz, 100Hz to 1 KHz , 1 KHz to 10KHz
10. Amplitude : 0 to 4Vpp. (Except Square)
11. Voice Communication : Fiber Optic voice link using dynamic MIC & SPEAKER
12. Signal strength indicator : 8 LED's provided to measure optical power.
13. Fiber Optic Cable:
14. Type : 1000 micron Step Index, Multimode Plastic Fiber
15. Fiber Lengths : 1&5 Meter.
16. Power Supply : GND, +5V, +12V, -12V at 100mA INT.

List of Experiments:

01. Light traveling around corners in an Optical Fiber
02. Coloured light traveling down an Optical Fiber
03. Photo detector detecting light
04. LED output as a function of a current
05. LED shining light into
06. Transmission of light between two fibers
07. Transmission through a gap between fibers
08. Fiber Optic transmission sensor
09. Fiber Optic reflection sensor
10. Measuring Losses in the fiber
 - * Measurement of propagation loss in the Fiber
 - * Measurement of connector loss
 - * Fiber bending loss
11. Measurement of Numerical Aperture of Optical Fiber
12. Setting up of Fiber Optic Analog Link
13. Setting up of Fiber Optic Digital Link
14. Setting of Fiber Optic Voice Link.
15. Switch Faults Study
 - * Effect of switch fault 1 in function generator section
 - * Effect of switch fault 2 in audio pre amplifier section
 - * Effect of switch fault 3 in signal strength section
 - * Effect of switch fault 4 in audio amplifier section

Accessories:

01. Red Short Links : 10 Nos.
02. Crocodile Links : 02 Nos.
03. Plastic Fiber 1 Meter (with connector) : 01 No.
04. Plastic Fiber 5 Meter (with connector) : 01 No.
05. N.A. Jig&N.A Scale : 01 No. Each
06. Connection Sleeves (Splicing unit) : 01 No.
07. Microphone : 01 No.
08. Speaker : 01 No.
09. Experimental Manual : 01 No.
10. Mandrel : 01 No.

Other Apparatus Required:

01. Cathode Ray Oscilloscope 20MHz

Digital Fibre Optic Power Meter

Order Code - 28509

Digital-Fibre-Optic Power Meter has been designed with an idea to make available Optic power measurement in the laboratory. It will replace costly Optical Power Meter to facilitate Optic power measurement in dBm.

Features:

01. Measures -10dBm to -30dBm
02. Digital Display
03. Measures Power at 660nm and 850nm wavelength
04. Portable with compact size and light weight

Specification:

- Range : Low : -20dBm to -30dBm
High : -10dBm to -20dBm.
- Accuracy : ± 0.5 dB.
- Display : 3½ digits 7 segment LED (12.5mm height) with auto polarity and decimal indication
- Input : SMA Connector
- Calibrated wavelengths: 660nm and 850nm.
- Power Requirement : 230V \pm 10%, 50Hz AC Mains.

Elementary Fiber Optics Trainer

Order Code - 28510



Fiber Optics Trainer is designed to learn the basics of Fiber Optics. The trainer demonstrates properties of Fiber Optics Transmitter & Receiver, characteristics of Fiber Optics Cable and different types of Modulation / Demodulation techniques. A large number of experiments are included in the workbook and many more can be performed. It can also be used to demonstrate various Digital Communication techniques via Fiber Optic link using Digital Communication Trainers.

Features:

01. Simplex Analog and Digital Transceiver
02. 660 nm channel with Transmitter & Receiver
03. AM-FM-PWM modulation / demodulation
04. On board Function Generator
05. Crystal Controlled Clock
06. Functional Blocks indicated on-board mimic
07. Input-output & test points provided on board
08. On board voice link
09. Built in DC power supply
10. Numerical Aperture measurement jig and mandrel for bending loss included
11. Switched faults on Transmitter & Receiver
12. Operating manual contains theory of Fiber Optics
13. Technology, experiments and glossary of Terms
14. Experiments that can be performed

Technical Specifications:

- Transmitter : 1 No., Fiber Optic LED having peak wavelength of emission 660 nm
- Receiver : 1 No., Fiber Optic Photo - detector
- Modulation Techniques: Drivers : 1. AM 2. FM 3. PWM
- Drivers : 1 No. with Analog & Digital modes
- Clock : Crystal Controlled Clock 4.096 MHz
- PLL Detector : 1 No.
- AC Amplifier : 1 No.
- Comparator : 1 No.
- th Filters : 1 No. 4 order Butterworth, 3.4 KHz cut off Frequency
- Analog Band Width : 350 KHz
- Digital Band Width : 2.5 MHz
- Function Generator : 1 KHz Sine wave (Amplitude adjustable)
1 KHz square wave (TTL)
- Voice Link : F. O. Voice link using microphone & speaker (built in)
- Switched Faults : 4 in transmitter & 4 in Receiver
- Fiber Optic Cable : Connector Type Standard SMA
- Cable Type : Step indexed multimode PMMA plastic cable
- Core Refractive Index : 1.492
- Clad Refractive Index : 1.406
- Numerical Aperture : Better than 0.5
- Acceptance Angle : Better than 60 deg.
- Fiber Diameter : 1000 microns
- Outer Diameter : 2.2 mm
- Fiber Length : 0.5 m & 1 m
- Test Points : 29
- Inter connections : 4 mm sockets
- Power Supply : 220 V \pm 10 %, 50 Hz / 60 Hz on request
- Power Consumption : 3 VA (approx.)
- Accessories Included : Line cord, Manuals, NA Measurement Jig, Mandrel, Fiber Cables, Microphone, Headphone, Set of Patch Cords
- Optional Accessories : Optical Power Meter, 5 meter fiber cable, 10 meter fiber cable.

Experiments:

01. Setting up Fiber Optic Analog & Digital Link
02. AM system using Analog & Digital Input Signals
03. Frequency Modulation System Pulse Width Modulation System
04. Study of Propagation Loss in Optical Fiber
05. Study of Bending Loss
06. Measurement of Numerical Aperture
07. Characteristics of E-0 Converter (LED)
08. Characteristics of Fiber Optic Communication Link
09. Setting of Fiber Optic Voice Link using Amplitude, Frequency & PWM Modulation
10. Frequency & PWM Modulation
11. Study of Switched Faults in AM, FM & PWM system
12. Propagation loss using Optical Power Meter

Advanced Fiber Optics Trainer

Order Code - 28511



Fiber Optics as a new transmission medium has revolutionized the telecom industry. It has numerous advantages over traditional wired or wireless transmission systems. Thus study of Fiber Optic communication systems has become more important. Advanced Fiber Optics Trainer is designed to learn the communication techniques in Fiber Optics. The trainer demonstrates properties of Fiber Optics Transmitter & Receiver, characteristics of Fiber Optics Cable, different types of Modulation / Demodulation techniques and PC to PC communication via fiber link using RS232 interface. It can also be used to demonstrate various Digital Communication Techniques via Fiber Optic link using Digital Communication Trainers.

Features:

01. Full Duplex Analog & Digital Trans-receiver
02. Single Module covering large number of experiments including experiments with Optical Power Meter
03. 660 nm & 950 nm channel with Transmitter & Receiver
04. AM-FM-PWM modulation / demodulation PC-PC comm. with RS232 ports & software
05. On board Function Generator
06. Crystal Controlled Clock
07. Functional Blocks indicated on-board mimic
08. Input-output & test points provided on board
09. On board voice link
10. Built in DC power supply
11. Numerical Aperture measurement jig and mandrel
12. for bending loss included
13. Switched faults on Transmitter & Receiver

Technical Specifications:

Transmitter	: 2 No., Fiber Optic LED having peak wavelength of emission 660 nm & 950 nm
Receiver	: 2 Nos., Fiber Optic Photo-detector
Modulation Techniques Drivers	: 1. AM 2. FM 3. PWM
AC Amplifier	: 1 No. with Analog & Digital modes
Clock	: 2 Nos.
PLL detector	: Crystal Controlled Clock
Comparator	: 4.096 MHz
Filters	: 1 No.
Analog Band Width	: 2 Nos.
Digital Band Width	: 2 Nos. 4 order Butterworth, 3.4 KHz cut off frequency
Function Generator	: 350 KHz
Voice Link	: 2.5 MHz
PC-PC Communication Port	: 1. 1 KHz Sine wave (Amplitude adjustable) 2. 1 KHz square wave (TTL)
	: F.O. voice link using microphone & speaker (built in)
	: Using 2 channel RS232
	: RS232 9 Pin

Baud Rate	: 19200 baud
Switched Faults	: 4 in transmitter & 4 in Receiver
Fiber Optic Cable	: Connector Type Standard SMA
Cable Type	: Step indexed multimode PMMA plastic
Core Refractive Index	: 1.492
Clad Refractive Index	: 1.406
Numerical Aperture	: Better than 0.5
Acceptance Angle	: Better than 60 deg.
Fiber Diameter	: 1000 microns
Outer Diameter	: 2.2 mm
Fiber Length	: 0.5m & 1m
Test Points	: 50
Inter connections	: 4 mm sockets
Power Supply	: 220 V \pm 10 %, 50 Hz / 60 Hz on request
Power Consumption	: 4.5 VA (approx.)
Accessories Included	: Line cord, Manuals, NA Measurement Jig, Mandrel, Fiber Cables, Microphone, Headphone, Set of Patch Cords, PC - PC Communication Software
Optional Accessories	: Optical Power Meter, 5 meter fiber cable. 10 meter fiber cable

Multiplexer / Demultiplexer Coder-Decoder Trainer

Order Code - 28512



The trainer provides all necessary inputs and connections for students to study Analog Time Division Multiplexing / Demultiplexing, Digital Time Division Multiplexing / Demultiplexing of signals, Pulse Position Modulation and Manchester Encoding / Decoding technique. Trainer can be used independently or can be used to establish fibre optic link by using Fiber optic Trainer

Features:

01. Functional blocks indicated on board mimic
02. Crystal Controlled Clock
03. On board Sine wave and Digital Signal Generator
04. 4-channel Time Division Multiplexing/ Demultiplexing (Analog)
05. 16-channel Time Division Multiplexing/ Demultiplexing (Digital)
06. Manchester Coding and Decoding
07. Pulse Position Modulation
08. Can be used with Fiber Optic & various other
09. Communication Links

Technical Specifications

Crystal Frequency	: 4.096 MHz
Analog Input Channels	: 4
Digital Input Channels	: 16
On Board Analog Signals	: 250 Hz, 500 Hz, 1 KHz, 2 KHz (Adjustable Amplitude)

On Board Digital Outputs :	1 . 16 Square Wave Frequencies (1 KHz - 2 Mhz)
	2 . Clock Generator
	3 . 8 bit data
Modulation :	Pulse Position Modulation
Multiplexing :	Time Division Multiplexing (4 Channel Analog and 16 Channel Digital)
Coding :	Manchester Coding and Decoding
Test Points :	27
Interconnections :	4mm. Sockets
Power Supply :	220 V \pm 10 % , 50 Hz / 60 Hz on request
Power Supply :	2 VA(approx.)
Accessories :	Manual, Mains cord, Patch Cords

Experiments:

01. Study of 4-channel Analog Time Division
02. Multiplexing / Demultiplexing
03. Study of 16-channel Time Division Mux / Demux
04. Multiplexing/Demultiplexing
05. Study of Pulse Position Modulation/Demodulation
06. Study of Manchester Coding and Decoding
07. Order Code No. 28512 can be also used with Fiber Optic Trainer Order Code No. 28510 & 28511

Optical Video Link Trainer

Order Code - 28513



Optical Video Link Trainer provides study of Transmission and Reception of Video Signal via optical fiber. It consists of transmitter unit, Receiver unit, SC-SC path cord and other accessories to conduct experiments. VCD player, Colour Television, Function Generator & CRO are needed additionally. Transmitter module has video input optical output and test points. Receiver module has optical input, video output and test points. It can also be used to demonstrate optical video link using function Generator and CRO

Features:

01. Self Contained ready to use Video link.
02. Applicable for Industrial Video link.
03. Test Point provided on Transmitter and Receiver

Technical Specification:

LASER Modulation at 1550nm.

Modulation Input

01. Video Signal
02. Function Generator Signal

Accessories Included:

01. Adaptor 12 DC 2Nos.
02. SC-SC Patch cord 1No.
03. Video Cables (Single) 2Nos.
04. BNC -2mm Cables 2Nos.

Experiments:

01. To compare video input signal and video output signal via optical video link
02. To observe LASER modulator input signal and

- optical detector output signal
03. To observe triangular, square, sine etc. Signal transmission via optical video link

WDM Trainer

Order Code - 28514



Wavelength Division Multiplexing is a technology which simultaneously transmits Multiple Optical Channels (wavelength) through a Single Fiber. Today WDM technique is as much a part of optical networking as the fiber itself. The application of WDM technology has spread over cable TV, optical networking, communication, EDFA and many other areas. WDM is a simple and reliable network which is free from effect of electromagnetic interference and capable of supporting broadband communications. They carry both analog and digital information over separate wave lengths. In WDM two or more channels are combined or split to ensure Bi-direction communication over a single fiber. WDM Trainer 28514, is designed for easily understanding of the Technique.

The Trainer is in 3 parts :

01. Main unit comprising of Multiplexer & Demultiplexer
 02. Inputs (Light sources) 1550 & 1310nm (Optional)
 03. Output (Optical power meters) (Optional)
- The trainer can also be used as WDM demonstrator with Optional Video Link

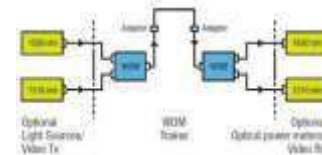

Features:

01. Demonstrates combination and separation of two
02. wavelengths
03. High channel isolation
04. Low insertion loss
05. Bi-directional

Technical Specifications:

Operating wavelengths	: 1310 & 1550 nm
Coupling Ratio	: 50/50
Port	: 1 x 2 and 2 x 1
Connector type	: FC
Length of single fiber	: 1 M

Optional :

Set I

- a) Light Source- 2 Nos.
- b) Power Meter- 2 Nos

Set II

- a) Video Link 1310 nm
- b) Video Link 1550 nm
- c) CD player and Colour Television. (14")

Experiments:

01. Testing the isolation of ports
02. (With Light source & Power Meter)
03. Testing of coupling ratio

04. (With Light source & Power Meter)
05. Measurement of output power
06. (With Light source & Power Meter)
07. Demonstration of WDM (With Video Link)
08. Bi-directional demonstration (Both)

Laser Fiber Optic Trainer

Order Code - 28515



The Laser Trainer has been designed to conduct studies on laser diodes, optical fibers and optical communication methods, by transmission either through an optical cable or free space. The experiments introduce the student to the concepts underlying laser technology in simple way. The trainer includes accessories to conduct experiments, however instrument like DMM are needed extra. Seven experiments based on the have been included in the manual with full details. The students can design a number of other experiments and do small projects based on the trainer.

Technical Specifications:

Transmission Module	:	Laser 660 nm
Mode	:	ACC & APC
Receiver Module	:	1) Photo transistor 2) Pin Diode
Power Supply	:	6 V DC Adaptors (plug to 230 V Mains)

Contents

Transmitter	1 No.
Receiver	1 No.
Fiber optic cable (Plastic)	1 No.
Fiber optic cable (glass)	1 No.
Power Adopter	2 Nos.
NA measurement Jig	1 No.
DMM optional	

Experiments:

01. Characterization of a laser diode
 - a) Optical Power Output vs LD Forward Current.
 - b) Monitor Photodiode Current vs Optical Power Output
02. Study of ACC and APC modes of operation.
 - a) Comparison of ACC & APC modes of operation
03. Design and Evaluation of an LD analogue IM system.
 - a) V_o vs V_{in} at specified Optical Carrier Power level P_o
 - b) Determination of V_{in} (max) at specified P_o for Distortion free V_o .
 - c) Comparison of ACC and APCIM systems
04. Design and Evaluation of LD digital transmission system
 - a) Rise time and fall time pulse width distortion.
05. Transmission of Laser through an Optical Fiber
 - a) Study with step-index Multimode Plastic Fiber Patchcord
 - b) Study with Graded-Index , Multimode Glass Fiber Patchcords.
 - c) Study with One Mechanical Splice Connecting the above Two Patchcords.
06. Laser free space communication.

- a) Analogue Free Space Communication System.
 - b) Digital Free Space Communication System
07. For numerical aperture measurement.
- a) NA of PMMA Fiber.

Fibre Optics - Digital Link

Order Code - 28516



28516 - FIBER OPTICS DIGITAL LINK is designed to learn basic fiber optics including fiber end preparation. Students can also study the construction of transmitter & receiver to form digital link. Ample number of experiments can be performed with this kit by referring to the exhaustive manuals provided with the kit.

Object:

01. Setting up Fiber Optic Digital Link
02. Study of Intensity Modulation Technique using Digital Input Signal
03. Characteristics of E-O Converter
- 04 Measurement of Numerical Aperture

Technical Specifications:

Transmitter	:	One number Fiber Optic LED having peak wavelength of emission 660 nm
Receiver	:	One number. Fiber Optic Photodetector
Driver	:	Digital
Cable Type	:	Step indexed multimode PMMA plastic cable
Connector Type	:	SMA
Analog bandwidth	:	35KHz.
Digital Bandwidth	:	50KHz.
Fiber Diameter	:	1000 microns
Clad Refractive Index	:	
Core Refractive Index	:	1.492
Numerical Aperture	:	Better than 0.5
Power Supply	:	+5V & +9V at 100mA
Variably Power Supply	:	0-20V at 20mA
Square Wave Generator	:	1KHz, 2V pp
Fiber Lengths	:	1 Meter.
Test Point	:	4 Nos
Weight	:	1.5 Kg. (Approx)
Dimension	:	W340xH125xD210

List Of Accessories:

01. Patch Cords 2mm to 2mm, Length 50cm Red...02
02. Fiber Optical Cable 1 Meter.....01
03. N.A. Jig & N.A. Scale.....01
04. Experimental Manual, Mains lead.....01

Other Apparatus Required:

01. Cathode Ray Oscilloscope 10MHz
02. Digital Fiber Optic Power Meter

Fibre Optics - Analog Link

Order Code - 28517



28517 - FIBER OPTICS ANALOG LINK is designed to learn basic fiber optics including fiber end preparation. Students can also study the construction of transmitter & receiver to form analog link. Ample number of experiments can be performed with this kit by referring to the exhaustive manuals provided with the kit.

Object:

01. Setting up Fiber Optic Analog Link
02. Study of Intensity Modulation Technique using Analog Input Signal
03. Measuring Losses in the fiber
 - * Measurement of propagation loss in the Fiber
 - * Measurement of connector loss
04. Fiber Bending Loss
05. Measurement of Numerical Aperture of Optical Fiber

Technical Specifications:

Transmitter	: One number Fiber Optic LED having peak wave-length of emission 635 nm
Receiver	: One number. Fiber Optic Photodetector
Driver	: Analog
Cable Type	: Step indexed multimode PMMA plastic cable
Connector Type	: SMA
Analog Bandwidth	: 35KHz.
Digital Bandwidth	: 50KHz.
Fiber Diameter	: 1000 microns
Clad Refractive Index	: 1.406
Core Refractive Index	: 1.492
Numerical Aperture	: Better than 0.5
Power Supply	: ± 12 V at 100mA
Sine Wave Generator	: 1KHz, 6V pp
Signal Strength Indicator	: 8 LED
Fiber Lengths	: 1 & 5 Meter.
Test Point	: 4 Nos.
Weight	: 1 Kg. (Approx.)
Dimension	: W340 x H125 x D210.

List of Accessories:

- | | |
|---|----|
| 01 Patch Cords 2mm to 2mm, Length 50cm Red | 02 |
| 02 Fiber Optical Cable 1 Meter..... | 01 |
| 03 Fiber Optical 5 Meter..... | 01 |
| 04 N.A. Jig & N.A. Scale..... | 01 |
| 05 Mains lead..... | 01 |
| 06 Mandrel..... | 04 |
| 07 Metallic Connection Sleeves (Splicing Unit)..... | 01 |

Other Apparatus Required:

01. Cathode Ray Oscilloscope 20MHz
02. Digital Fiber Optic Power Meter

Optical Power Meter

Order Code - 28518



Order Code 28518, Optical Power Meter is Hand Held Power Meter which provides performance, durability and stability for measurement of optical power. Switches are provided for meter 'On/Off' and wavelength selection. The readings indicated on the meter are directly calibrated in dBm. The standard 9V battery is easily replaceable from the separated battery component on the backside of the meter.

Features:

Input	: 180 V Fixed DC
Detector	: Silicon detector
Range	: 0 dBm to -60 dBm
Display	: 12 mm LCD
Wavelength	: 660 & 950 nm*
Connector	: SMA
Accuracy	: 0.5 dBm
Power	: 9 V Battery
Size (mm.)	: W 100 × D 45 × H 175
Learning material	: Theory, procedure, reference results

LED Radiation Pattern Trainer

Order Code - 28519



Trainer is designed to learn the LED characteristic (Input LED angle vs. output voltage). LED is a commonly used semiconductor device that emits incoherent narrow spectrum light. LED plays a very important role in today's industrial and domestic applications. In 28519 we use three LEDs (Red, Blue and Green). The characteristic is widely used in various transmitting and receiving scheme and data communication. 28519 trainer is a self contained experiment module which comes with detailed manual and required accessories.

Features:

01. Self contained and easy to operate
02. Sensitive, linear & accurate
03. On board transmitter and receiver
04. Built in DC power supply
05. Functional blocks indicated on board mimic
06. 2 mm sockets for measurement
07. Null adjustment for atmospheric light
08. High repeatability and reliability

Technical Specification:

Transmitter :

Wavelength (nm)	: 565 nm (For Green light)
LED Rotation	: 0 -360 deg with resolution of 1 deg
Transmitter circuitry	: LED mast
Wavelength (nm)	: 700 nm (For Red light)

Wavelength (nm) : 430 nm (For Blue light)

Receiver :

Wavelength (nm) : 940nm
Receiver circuitry : Silicon phototransistor & Zero adjustment circuit.

General Specifications:

Power Supply : 220 V ±10%, 50 Hz / 60 Hz on request
Power Consumption : 2.4 VA (approx.)

Connectorization & Splice Kit

Order Code - 28520 to 28521



Connectorization Kit - 28520

Connectorization & Splice Kit - 28521

In Optical Fiber to make to optically perfect joint one has to match exactly the glass surfaces of both the fibers. Any mismatch or gap between the surfaces increases the optical losses during transmission. Fiber preparation, Inserting the fiber into the connector, applying epoxy, cutting the fiber, & polishing the surface are very important aspects of the process and requires lot of practice.

These kits contain all necessary tools, consumables, connectors and cable to demonstrate and practice the process. A neatly written step by step procedure with pictures is provided in the Instruction booklets. These kits form an important part of the Fiber Optic Laboratory making students understand how optical fibers are joined and terminated.

Technical Specifications:

- 01. Crimp Tool : 1
- 02. Red No Nik tool : 1
- 03. Jacket Stripper : 1
- 04. Scissors : 1
- 05. Diamond Scribe : 1
- 06. Polish Films 5u, 1u, 0.3u, (3 each): 1 Pack
- 07. 2 Part Epoxy : 3 Packs
- 08. Syringe & Needle : 3 Packs
- 09. Polishing Disc : 1
- 10. Polishing Pad : 1
- 11. Work Mat : 1
- 12. Glass Plate : 1
- 13. Measuring Scale : 1
- 14. Cable Markers : 1Pack
- 15. Knife : 1
- 16. Tweezers : 1
- 17. Screw Driver : 1
- 18. Marker Pen : 1
- 19. Tissue Papers : 1Pack
- 20. Alcohol : 1Pack
- 21. Foam Swabs : 1Pack
- 22. Piano Wire : 1
- 23. X100 Microscope : 1
- 24. Continuity Tester : 1
- 25. Connectors : 1
- 26. Glass Fiber Cable 62.5/125 : 10 meters
- 27. VIP Carrying Case : 1
- 28. Storage Boxes : 6
- 29. ULTRA Splice (Mechanical) : 2 (Only in Order Code 28521)

Fiber Optic Connectors & Cables Kit

Order Code - 28522 to 28523



28522 - Connectors Kit



28523 - Cables Kit

Fiber Optic Connectors Kit and Fiber Optic Cables Kit are displays for Fiber Optic Connectors & Cables firmly mounted on a colorful sheets.

Only popular type of connectors & cables are selected which are used in Fiber Optic networking. Housed in a wooden box with Acrylic cover, the technical details and application of each Connector, Adaptor & Cable is written alongside of the item so that trainees can understand their construction, applications and losses etc.

Fiber Optic Power Meter

Order Code - 28524



Features:

- 01. Use of Germanium photodiode.
- 02. Wavelength range : 850nm,1310nm,1550nm.
- 03. Measurement range : +3dbm~50dbm, 0.4dBm.
- 04. Output: 1mV per 1dB.
- 05. Low battery indicator.
- 06. Connector: ST, FC, Multi (option).

Accessories:

- 01. Carrying Case : 1pcs.
- 02. DC 9V alkaline battery x 1pcs.
- 03. User Manual x 1pcs.

Fibre Optics Modulation/Demodulation Trainer

Order Code - 28525

28525 is a single board Fibre Optics Modulation/ Demodulation Trainer Kit to study the characteristics of Fiber using Digital and Analog techniques. This kit also facilitates with digital and analog Modulation & Demodulation communication techniques.

Features:

- 01. Two Nos. Of Photo Detector.
- 02. On-board Sine & Square wave generator.
- 03. On-board 4th Order Low Pass Filter.
- 04. On-board Fault Switch.
- 05. In-Built Power Supply.

Specifications:

- * Two Transmitter Fiber Optics LED having peak wavelength of emission 660nm & 950nm.
- * Two Receiver Fiber Optic photodetector
- * On-board Analog & Digital Drivers.
- * On-board AC Amplifiers.
- * Analog Band Width 350 Khz.
- * Digital Band Width 2.5 Khz.

- * 4th order Butter worth 3.4KHz Low Pass Filter.
- * On-board 1Hz. To 10 KHz sine wave (amplitude adjustable), Square wave (NRZ-TTL 8 Bit)
- * FO voice link using microphone & speaker
- * RS-232C PC to PC Serial link using 9 Pin Dtype.
- * Four Switched Faults for transmitter & receiver.
- * Fiber Optics Cable Connector type Standard SMA .
- * Duly polished fiber at both end for Numerical Aperture Measurement.
- * Step indexed multimode PMMA plastic cable.
- * Core Refractive Index 1.492.
- * Clad Refractive Index 1.406.
- * Numerical aperture Better than 0.5.
- * Acceptance Angle Better than 60°
- * Fiber Diameter 1000 microns.
- * Outer Diameter 2.2mm.
- * Fiber Length 1m.
- * In-Built Power Supply +5V/1.5A, ±12V/250mA.
- * Interconnections 2 mm Banana Sockets
- * Attractive Wooden enclosures of Light weight Australian Pine Wood.
- * User's Manual with set of Patch Chords.
- * 230mm x 140mm x 80mm (L x W x H)
- * Weight 3 Kgs.

Experiments:

01. Setting up Fiber Optic Analog Link
02. Setting up Fiber Optic Digital Link
03. Study of Intensity Modulation Technique using Analog Input Signal
04. Study of Intensity Modulation Technique using Digital Input Signal
05. Setting up of Propagation Loss in Fiber Optic
06. Study of Bending Loss.
07. Measurement of Optical Power using Optical Power Meter
08. Measurement of Propagation loss using Optical Power Meter
09. Measurement of Numerical Aperture
10. Characteristics of F-O Converter using OPM
11. Characteristics of Fiber Optic communication Link
12. Setting up of Fiber Voice Link using Intensity Mode
13. Study of PC to PC Communication using Fiber Optics Digital Link

Fibre Optics Communication Trainer without PC Communication Facility

Order Code - 28526



Order Code -28526 is a single board Fiber Optic Trainer Kit to study the characteristics of Fiber using Digital and Analog techniques. This kit also facilitates with digital and analog Modulation & Demodulation communication Techniques.

Features:

- 01. 660nm and 950nm Transmitter.
- 02. Two Nos. Of Photo Detector.
- 03. On-board Sine & Square wave generator.
- 04. On - board FM Modulation & Demodulation
- 05. On-board PWM Modulation & demodulation.
- 06. On-board PPM Modulation & Demodulation.

- 07. On-board 4th Order Low Pass Filer.
- 08. On-board Fault Switch.
- 09. In-Built Power Supply.

Fibre Optics Communication Trainer with PC Communication Facility

Order Code - 28526A



Order Code -28526 is a single board Fiber Optic Trainer Kit to study the characteristics of Fiber using Digital and Analog techniques. This kit also facilitates with digital and analog Modulation & Demodulation communication Techniques.

Object:

01. Setting up Fiber Optic Analog Link
02. Setting up Fiber Optic Digital Link
03. Study of Intensity Modulation Technique using Analog Input Signal
04. Study of Intensity Modulation Technique using Digital Input Signal
05. Setting up of Propagation Loss in Fiber Optic
06. Study of Bending Loss.
07. Measurement of Optical Power using Optical Power Meter
08. Measurement of Propagation loss using Optical Power Meter
09. Measurement of Numerical Aperture
10. Characteristics of F-O Converter using OPM
11. Characteristics of Fiber Optic communication Link
12. Setting up of Fiber Voice Link using Intensity Mode
13. Study of Frequency Modulation and Demodulation
14. Study of Pulse Width Modulation and Demodulation
15. Study of Pulse Position Modulation and Demodulation
16. Study of PC to PC Communication using Fiber Optics Digital Link

Features:

- 01. 660nm and 950nm Transmitter.
- 02. Two Nos. Of Photo Detector.
- 03. On-board Sine & Square wave generator.
- 04. On - board FM Modulation & Demodulation
- 05. On-board PWM Modulation & demodulation.
- 06. On-board PPM Modulation & Demodulation.
- 07. On-board 4th Order Low Pass Filer.
- 08. On-board Fault Switch.
- 09. In-Built Power Supply.

Specifications:

- * Two Transmitter Fiber Optics LED having peak wavelength of emission 660nm & 950nm.
- * Two Receiver Fiber Optic photo detector.
- * Modulation & Demodulation Techniques using Direct AM, FM, PPM, PWM.
- * On-board Analog & Digital Drivers.
- * On-board AC Amplifiers.
- * On-board PLL Detector
- * Analog Band Width 350 Khz.
- * Digital Band Width 2.5 Khz.
- * 4th order Butter worth 3.4KHz Low Pass Filter.

- * On-board 1Hz. To 10 KHz sine wave (amplitude adjustable), Square wave (TTL)
- * FO voice link using microphone & speaker
- * RS-232C PC to PC Serial link using 9 Pin D -type.
- * Four Switched Faults for transmitter & receiver.
- * Fiber Optics Cable Connector type Standard SMA .
- * Duly polished fiber at both end for Numerical Aperture Measurement.

Aperture Measurement.

- * Step indexed multimode PMMA plastic cable.
- * Core Refractive Index 1.492.
- * Clad Refractive Index 1.406.
- * Numerical aperture Better than 0.5.
- * Acceptance Angle Better than 60o
- * Fiber Diameter 1000 microns.
- * Outer Diameter 2.2mm.
- * Fiber Length 5m & 1m.
- * In-Built Power Supply +5V/1.5A, ±12V/250mA.
- * Interconnections 2 mm Banana Sockets
- * User's Manual with set of Patch Chords.
- * 230mm x 140mm x 80mm (L x W x H)

Advance Fiber Optic Trainer

Order Code - 28527



Order Code- 28527 is a single board Fiber Optic Trainer Kit to study the characteristics of Fiber using Digital and Analog techniques. This kit also facilitates with digital and analog Modulation & Demodulation communication techniques.

Features:

01. 660nm and 850/950nm Transmitter.
02. Two Nos. Of Photo Detector.
03. On-board Sine & Square wave generator.
04. On-board Manchester Coding/ Decoding Technique.
05. On-board Noise Generator & PRBS Generator
06. On-board Bit Error Rate Measurement.
07. On-board PC to PC Communication.
08. On-board 4th Order Low Pass Filer.
09. On-board Fault Switch.
10. In-Built Power Supply.

Specifications:

- Transmitter : One Fiber Optics LED having peak wavelength of emission 660 nm. One Fiber Optics LED having peak wavelength of emission 850/950 nm.
- Receiver : Two Fiber Optic photo detector.
- Modulation Techniques : Digital communication with Pulse Code Modulation (PCM) using Motorola MC. 145502 CODEC Chip.
 - Manchester Coding / Decoding Technique.
 - White Noise Source output type Noise Generator
 - Amplitude of 0 to 5Vpp.
 - 16 Bit switch selectable PRBS generator

- Clock of 32, 64, 128 KHz.
- Bit error rate measurement of 8 bit counter with LED indication upto 255 count.
- Time Division Multiplexing, 16 Channels (64 Kbits/Sec).
- Two Frame Marker of 8 bit user selectable markers in alternate frames.
- Data Rate of 1.024 Mbits/Sec.
- 2 channels Voice PCM with Telephone Hand sets (A Law).
- Analog Input of 1Vp-p.
- Analog Bandwidth of 3.75KHz.
- FWHM Spectral Width of 100nm.

- Drivers : Analog & Digital
- AC Amplifiers : 1 Nos.
- PLL Detector : 1 No.
- Filters : 1 No 4th order Butterworth 3.4 KHz cut-off freq.

- Analog Band Width : 350 KHz.
- Digital Band Width : 2.5 KHz.
- Functional Generator : 1Hz. To 100 KHz sine wave (amplitude adjustable) 1Hz. To 100 KHz square wave (TTL)

- CODEC Link : Two Telephone Hand set provided

- Serial PC to PC link : 9 Pin D-type RS232C TX and Rx link (Max. 115.2 Kbps Baud)

- Switched Faults : 8 Switch Faults are provided to study different effects on circuit.

- Fiber Optics Cable : Connector type Standard SMA (Sub miniature assembly). Duly polished fiber at oth end for Numerical Aperture Measurement.

- Cable Type : Step indexed multimode PMMA plastic cable.

- Core Refractive Index : 1.492.
- Clad Refractive Index : 1.406.
- Numerical aperture : Better than 0.5.
- Acceptance Angle : Better than 60o
- Fiber Diameter : 1000 microns.
- Outer Diameter : 2.2mm.
- Fiber Length : 5m & 1m.
- Power Supply : Built in DC power supply, 230V + 10%, 50 Hz.

- Accessories Included : Manuals, set of patch cords.

- Interconnections : 2 mm Banana Sockets.

Optical Power Meter

Order Code - 28529A



Specifications:

- Input Supply : 9 volt DC/1 A

Display : 4 Digit LCD Display
 Switch : Pushbutton switch to 660nm /990nm
 Measuring unit : dBm.

Fibre Optics Cable - PMMA

Order Code - 28541-28544



Fibre Optics Cable - PMMA - 1 Meter - 28541

Fibre Optics Cable - PMMA - 2 Meter - 28542

Fibre Optics Cable - PMMA - 3 Meter - 28543

Fibre Optics Cable - PMMA - 5 Meter - 28544

Description:

Fiber optic cable is a light guide material. It don't emit light itself. So we need use a LED light source engine to give light from its end. As per the light emission and transmission principle, then light travel along fiber to the another end to get end-glowing lighting effect . It can travel all visible RGB and other color light.

Features:

- 01. Item Type : Optic Fiber Lights
- 02. Fiber Type : Transparent & plastic optical fiber

- 03. Fiber material : Plastic PMMA
- 04. Function : Transfer all visible light
- 05. Light color : RGB colorful
- 06. Light source : LED light engine, Halogen light machine
- 07. Fiber Optic Size : On Request
- 08. Advantage : Soft to cut easily, Electricity isolation, waterproof
- 09. Brightness
- 10. Not easy to break.
- 11. Uniform thickness
- 12. No UV or IR
- 13. Nice surface and transparent
- 14. Excellent toughness can bend random
- 15. Virtually no heat
- 16. Long life
- 17. Energy saving
- 18. Optic fiber light is a night lighting ideal light source, by using the theory of total reflection, light transmission through optical fiber to people need light anywhere for lighting.
- 19. Optical fiber safety, itself is not charged, not afraid of water, can suite many environment.
- 20. Optical fiber small size, soft and flexible, easy to create and make whatever you want shape.
- 21. Optical fiber long life, low maintenance workload.
- 22. Optical fiber bright colors and beat rhythm, widely used to make curtain, screen, ceiling sky decoration.

Linear Variable Differential Transducer (L.V.D.T) Trainer

Order Code - 52001



Instrumentation trainer has been designed specifically for to study Linear Variable Differential Transducer (L.V.D.T.). The board is absolutely self contained & require no other apparatus.

Practical experience on this set up carries great educative value for Science and Engineering Students.

Object:

Study of Linear Variable Differential Transducer (L.V.D.T.)

Features:

The instrumentation trainer consists of the following

01. One board having the following built in parts.
 - (a) $\pm 12V$ D.C. at 50mA I.C. regulated Power Supply for Sine wave Oscillator.
 - (b) 4KHz fixed Sine wave Oscillator having variable amplitude 0–10V (P–P).
 - (c) Digital Panel meter 3½ digits range 200mV.
 - (d) Detector circuit with output adjustment pot.
02. Transducer : Linear variable differential transducer (L.V.D.T.).
 - Range : $\pm 20mm$. (Accuracy $\pm 1mm$, ± 1 Digit)
 - Moving action : 6 wires, spring loaded type axial.
 - * Mains ON/OFF switch and fuse.
 - * Adequate no. of patch cords stackable 4mm spring loaded plug length ½ metre.
 - * Good Quality, reliable terminal/sockets are provided at appropriate places on panel for connections/observation of waveforms.
 - * Strongly supported by detailed Operating Instructions, giving details of Object, Theory, Design procedures, Report Suggestions and Book References.

Measurement and Control of Temperature Using RTD Transducer

Order Code - 52002



Industrial Control Transducer has been designed specifically for measurement and control of temperature using RTD Transducer. The board require other apparatus like heater and beaker.

Practical experience on this set up carries great educative value for Science and Engineering Students.

Object:

Measurement and control of temperature using RTD transducer

Feature:

The unit consists of following built in parts :

01. $\pm 12V$ DC at 100 mA, IC Regulated Power Supply
 02. 6 V DC at 100 mA, IC Regulated Power Supply
 03. Implementation of Wheatstone Bridge in temperature Control System
 04. Four Op-Amp. ICs
 05. Relay 12 V DC, one change over
 06. One NPN transistor
 07. 3½ digits display panel meter, to display temperature in $^{\circ}C$
 08. RTD sensor with 3 pin connector
 09. One switch for setting temperature on one side and to read actual temperature on other side
 10. Potentiometer to control temperature
 11. AC mains socket to connect load whose temperature is to be controlled
 12. Adequate no. of other Electronic Components
 13. Mains ON/OFF Switch and Fuse 400 mA
- * The unit is operative on 230V $\pm 10\%$ at 50Hz AC Mains
 - * Good Quality, reliable terminal/sockets are provided at appropriate places on panel for connections/ observation of waveforms
 - * Strongly supported by detailed Operating Instructions, giving details of Object Theory, Design, Procedures, Report Suggestions

Other Apparatus Required:

01. Heater 1000 W 230V
02. Beaker

Load Cell Demonstrator

Order Code - 52003



Looking to the recent requirement of educational institutions, we have developed. Load Cell Demonstrator. It shows digital display of measured weight. Practical experience on this board carries great educative value for Science and Engineering Students.

Object:

To study Load Cell Demonstrator

Features:

The board consists of following built in parts

01. $\pm 12V$ D.C. at 100mA, I.C. regulated Power Supply
 02. 5V D.C. at 100mA, I.C. regulated Power Supply
 03. IC for comparison of Load Signal
 04. Load Cell of 3kg with 200mV output
 05. DPM of 3½ digit display for 3kg
 06. Adequate no. of other electronic components
 07. Mains ON/OFF switch and fuse
- * The unit is operative on 230V $\pm 10\%$ at 50Hz A.C. Mains
 - * Good Quality, reliable terminal/sockets are provided at appropriate places on panel for connections/ observation of waveforms.
 - * Strongly supported by detailed Operating Instructions, giving details of Object, Theory, Design procedures, Report Suggestions and Book

References.

Other Apparatus Required:

01. 0 - 3 kg. Weights.

Optical Transducer Trainer

Order Code - 52004



Optical and Temperature transducers play a very important role in today's industrial and domestic applications. optical and Temperature Transducers Trainers are unique in design because each cover study of 4 different type transducers. Experiments covering fundamental characteristics of transducers & study of transducer controlled switching alarm systems can be performed with these trainers. These trainers comes with exhaustive manuals covering theory and experimental procedures for conducting experiments.

Technical Specification:

01. Transducers : 4Nos.
 - 1.1 Photoconductive Cell
 - 1.2 Photovoltaic Cell
 - 1.3 Photo transistor
 - 1.4 PIN Photo diode
02. Light Source : Filament Lamp
03. Signal Conditioning Circuitry
 - 3.1 Power Amplifier
 - 3.2 Current Amplifier
 - 3.3 DC Amplifier
 - 3.4 Comparator
 - 3.5 Electronic Switch
 - 3.6 Buffer
04. Input Circuits : Rotary&Slide Potentiometers
05. Output Circuits
 - 5.1 Moving Coil Meter
 - 5.2 Relay
 - 5.3 Buffer
06. Interconnections : 4mm banana sockets
07. Mains Supply : 100 - 240V, 50Hz. 60Hz on request
08. Power Consumption : 2VA(approx)
09. Accessories : Line cord, Manual, Set of Patch Cords

Scope of Learning:

01. Characteristics of filament Lamp
02. Characteristics of Photovoltaic Cell
03. Characteristics of Photoconductive Cell
04. Characteristics of Photo transistor
05. Characteristics of PIN Photo diode
06. Light Controlled Switch System

Ultrasonic Digital Distance Meter

Order Code - 52005



Ultrasonic Digital Distance Meter has been designed specifically for measuring distance between 0.3 metre to 3 metres. The measuring distance is shown on a 3

digit liquid crystal display LCD.

Practical experience on this set up carries great educative value for Science and Engineering Students.

Object:

To measure unknown distance between 0.3 metre to 3 metres

Features:

The unit consists of following built in parts :

01. Ultrasonic (Transmitter)
 02. Ultrasonic Receiver
 03. A timing and time reference section
 04. A counter with 3½ digit liquid crystal display LCD
 05. Adequate no. of other electronic components
- * The unit is operative on 9V DC Battery cell
 - * Good Quality, reliable terminal/sockets are provided at appropriate places on panel for connections/ observation of waveforms
 - * Strongly supported by detailed Operating Instructions, giving details of Object, Theory, Design procedures, Report Suggestions and Book References

Other Apparatus Required:

01. CRO.
02. Tape Scale.

Temperature Measurement Tutor Using AD - 590

Order Code - 52006



Has been designed specifically to study the Temperature Measurement Tutor using AD - 590. The board is self contained and require no other apparatus. Practical experience on this board carries great educative value for Science and Engineering Students.

Object:

To study the Characteristic of AD - 590

Features:

The board consists of following built in parts :

01. ± 12V D.C. at 100mA, I.C. regulated Power Supply internally connected
 02. 3-30V D.C. at 50mA, IC regulated Power Supply
 03. 30V D.C. at 600 mA. Unregulated power supply for oven
 04. Oven for heating AD-590
 05. Two AD-590, One for study of characteristic and one for maintaining the set temperature
 06. 3½ digits digital panel meter for temperature display
 07. 3½ digits digital panel meter with switch selection to read voltage range 0 - 200V and to read current 0 - 1999uA
 08. Potentiometer to set the temperature
 09. Adequate no. of other electronic components
 10. Mains ON/OFF switch and Fuse
- * The unit is operative on 230V ± 10% at 50 Hz A.C. mains
 - * Adequate no. of patch cords stackable 4mm spring loaded plug length ½ metre
 - * Good Quality, reliable terminal/sockets are

provided at appropriate places on panel for connections/observation of waveforms

- * Strongly supported by detailed Operating Instructions, giving details of Object, Theory, Design procedures, Report Suggestions and Book References

D.C. Motor Speed Control Trainer

Order Code - 52007



D.C. motor Speed control trainer built around a small permanent magnet D.C. motor is designed to bring out the salient features of such a system. Facilities are available to directly measure the principal performance features of the speed control system, viz, steady state error and load disturbance rejection, as a function of the forward path gain. In addition, the experimental work involves the determination of the motor transfer function and the characteristics of the tachogenerator. An important feature of the unit is the built-in absolute speed measurement through photo diode pick-up from a slotted disk followed by a frequency counter. Variable loading of the motor is achieved by a built-in eddy current brake.

Features:

01. Closed loop motor speed control with eddy current brake
02. Compact system-no mechanical hassles
03. Photo diode speed sensor
04. Digital speed display

Specifications:

- * Speed control of a 12V,4W permanent magnet D.C. motor
- * Speed range : 0 to 2500 rpm (typical)
- * Photo diode based speed sensing
- * 4-digit speed display in rpm
- * Electronic tacho generator for feedback
- * Separate unit for motor in a see through cabinet
- * Smooth, non-contact eddy current brake for loading
- * Built-in 3½ digit DVM for signal measurements
- * Built-in IC regulated internal power supply
- * The unit is operative on 230V ±10% at 50Hz A.C. Mains
- * Adequate no. of patch cords stackable from rear both ends 4mm spring loaded plug length 50cm.
- * Good Quality, reliable terminal/sockets are provided at appropriate places on panel for connections/observation of waveforms
- * Strongly supported by detailed Operating Instructions, giving details of Object, Theory, Design procedures, Report Suggestions and Book References

Experiments:

01. Effect of loading on the speed of the motor in the open loop
02. Steady state error variation with forward gain
03. System time constant variation with forward gain
04. Effect of forward gain on disturbance rejection
05. Determination of the motor transfer function and

tachometer characteristics

Other Apparatus Required:

01. Cathode Ray Oscilloscope 20MHz.

Control System Lab

Order Code - 52008



Control System Lab explores students & industry professional to the fundamentals of Control System. It demonstrates, how one device can be used to manage, command, direct or regulate the behavior of other system. Sequential Control, Linear Control is also well explained in the trainer. Control System Lab has sensors like Temperature sensor, Light sensor, DC motor, Filament lamps, IR sensor and many more which can be used for the study of Control system. There is a wide range of experiments which can be performed on the trainer. Application software for Interfacing with PC increases range of experiments.

Features:

01. Open loop Control system
02. Close loop Control system
03. Feedback concept
04. Servo motor control
05. DC motor control
06. Speed control
07. Light intensity control
08. Temperature Control
09. V/F & F/V conversion
10. LED bar display
11. Bread board for circuit design
12. User can design & develop own circuits
13. On board DC supply
14. PC interface for open loop & Close loop control
15. PC based Frequency counter
16. PC based DC voltmeter
17. Real time graphical representation
18. User friendly software
19. Exhaustive course material & references

Mini Process Control Demonstrator

Order Code - 52009



In this modern era, instrumentation & control engineering have major share for the industrial growth, whilst process control is a vital concept of it. The functionality and complexity of process control have been increased.

Mini Process Control Demonstrator endows students and industry professionals to understand the concepts and working of thermal process control which enables them to learn advance and more complex thermal

process; and contribute in the growth of instrumentation arena. It formulates students to accumulate, develop and practice the fundamentals of thermal process control.

Mini Process Control Demonstrator has sensors like temperature sensor, liquid level sensor, level indicators. It has safety measures such as emergency shutdown and overheat protector. There is a wide range of experiments that can be performed on the trainer. It also has computer interfacing with real time graphical analysis which helps to perform mathematical calculations required to state stability of process using methods like root locus, bode plot, etc. This feature increases the scope of doing research and implementing ones innovative ideas related to thermal process control.

Study of process with two position controller, PID controller and optionally with PLC.

Features:

01. Study of thermal Process Control
02. Temperature Controller
03. Use of Industrial Process Control Elements
04. Signal Conditioning
05. Control Quality and Optimum Control
06. Process Loop Tuning & Stable Process
07. Real-time PC interface with ADC & Digital input/output
08. Process Control by ON/OFF Controller
09. Process Control by PID with Auto Tuning
10. Optional process control by using PLC
11. Process Control Loops
12. Mathematical Modeling and Calculations
13. Stability of Process using Root Locus, Bode Plot , etc
14. Process Indicators
15. PC Interface for Open Loop & Close Loop Control
16. PC Based Temperature Indicator
17. Print and Save Feature for Real Time Data and Graph
18. Real Time Graphical Representation
19. User Friendly Software
20. Exhaustive Course Material & References

Technical Specifications:

Vessel Capacity	: 2 Litres
Temperature Measurement	: RTD (-99 to 850°C)
Heater	: 230 VAC
Temperature Range	: from room temperature to 100°C
Temperature Indicator	: 0 to 850°C
Control Valve	: Manually Operated
Stirrer	: 0 or 5 V DC
Level Sensor	: 0 or 5 V DC
Indicators	: Level Indicators Stirrer Indicator Heater Indicator
Relay Action	: Forward for Cooling and Reverse for Heating
PID Controller	: Hardware based & Computer based
ON/OFF Controller	: Hardware based & Computer based
Computer Interface	: USB
Analog Input	: One (0 to 5 V DC)
Digital Input	: Two (TTL)
Digital Output	: Two (TTL)
Switches	: Two (TTL)

Signal Conditioning	: Amplifiers with gain of 1 and 10
PC Based Temperature Indicator	: 0 to 100°C
Power Supply	: 230V \pm 10%, 50 Hz (others on request)



Software Window

Temperature Process Control Trainer

Order Code - 52009A



52009A Temperature control trainer is designed for understanding the basic temperature control principles for the Process control mounted on Aluminum profile rack with sturdy table top flat panel. The process setup consists of heating tank fitted with SSR controlled heater for on-line heating of the water. The flow of water can be manipulated and measured by rotameter. Temperature sensor (RTD) is used for temperature sensing. The process parameter (Temperature) is controlled by microprocessor based digital indicating controller which manipulates heat input to the process. Each panel has ABS molded plastic sturdy enclosure with 4mm shrouded connectors showing circuit diagram & its connection tag numbers for easy understanding and connections.

Specifications:

- * Trainer having control panel should provided in 40X40mm Aluminum profile rack with sturdy table top flat panel.
- * Should have ABS plastic panel mounted on the aluminum rack with mimic diagram
- * All input & output are terminated in 4mm shrouded connector,
- * Should provide 4mm banana cable for experiments.
- * Type of control PID
 - Control unit Digital indicating controller
 - Temperature sensor Type RTD, Pt100
- * Heating control Proportional power controller (SSR), Input 4-20 mA, Capacity 20 A
- * Heater Type Electrical 2 coil, Capacity 3 KW
- * Rotameter 6-200 LPH
- * Process tank Capacity 0.5 lit, insulated
- * 230 +/- 10 VAC, 50 Hz, 1 phase with On/Off Switch.

Experiments:

01. Study of open loop (Manual control)
02. Study of on/off controller

- * Study of proportional controller
- * Study of prop. integral controller
- * Study of prop. derivative controller
- * Study of PID controller

Flow Process Control Trainer

Order Code - 52009B

52009B Flow control trainer is designed for understanding the basic Flow control principles for the Process control mounted on Aluminum profile rack with sturdy table top flat panel. The process setup consists of supply water tank fitted with pump for water circulation. A DP transmitter is used for flow sensing which measures differential pressure across orifice meter. The process parameter (flow) is controlled by microprocessor based digital indicating controller which manipulates pneumatic control valve through I/P converter. The control valve is fitted in water flow line. Each panel has ABS molded plastic sturdy enclosure with 4mm shrouded connectors showing circuit diagram & its connection tag numbers for easy understanding and connections.



Specifications:

- * Trainer having control panel should provided in 40X40mm Aluminum profile rack with sturdy table top flat panel.
- * Should have ABS plastic panel mounted on the aluminum rack with mimic diagram
- * All input & output are terminated in 4mm shrouded .connector, Should provide 4mm banana cable for experiments.
- * Type of control PID
 - Control unit Digital indicating controller
 - Input Type 4-20mA
- * I to P converter Input 4-20mA, Output 3-15 psig
- * Control valve Type Pneumatic, Size 1/2", Input 3-15 psig, Air to close, Linear type
- * Rotameter 10-200 LPH
- * Pump Fractional horse power type submersible with sump tank
- * Flow measurement sensor, output 4-20mA
- * Air filter regulator Range 0-2.5 kg/cm²,
- * Pressure gauge Range 0-2.5 kg/cm²(1No), Range 0-7 kg/cm²(1No)
- * 230 +/- 10 VAC, 50 Hz, 1 phase with On/Off Switch.
- Optional: Mini compressor

Experiments:

- * Study of open loop (Manual control)
- * Study of on/off controller
- * Study of proportional controller
- * Study of prop. integral controller
- * Study of prop. derivative controller
- * Study of PID controller

Temperature Process Control Trainer (air)

Order Code - 52009C



52009C Temperature control trainer is designed for understanding the basic temperature control principles for the Process control mounted on Aluminum profile rack with sturdy table top flat panel. The process setup consists of heating chamber fitted with SSR controlled heater for on-line heating of the air. Temperature sensor (RTD) is used for temperature sensing. Fan is fitted in the chamber for maintaining the temperature. The process parameter (Temperature) is controlled by microprocessor based digital indicating controller which manipulates heat input to the process. Each panel has ABS molded plastic sturdy enclosure with 4mm shrouded connectors showing circuit diagram & its connection tag numbers for easy understanding and connections.

Specifications:

- * Trainer having control panel should provided in 40X40mm Aluminum profile rack with sturdy table top flat panel.
- * Should have ABS plastic panel mounted on the aluminum rack with mimic diagram
- * All input & output are terminated in 4mm shrouded connector, Should provide 4mm banana cable for experiments.
- * Type of control PID
 - Control unit Digital indicating controller
 - Temperature sensor Type RTD, Pt100
- * Heating control Proportional power controller (SSR), Input 4-20 mA, Capacity 20 A
- * Heater Type 3 bulb , Capacity 300 W
- * Process Chamber: Fitted with bulb & Cooling Fan.
- * 230 +/- 10 VAC, 50 Hz, 1 phase with On/Off Switch.

Experiments:

01. Study of open loop (Manual control)
02. Study of on/off controller
03. Study of proportional controller
04. Study of prop. integral controller
05. Study of prop. derivative controller
06. Study of PID controller

Level Process Control Trainer

Order Code - 52009D



52009D Level control trainer is designed for understanding the basic Level control principles for the Level Process control mounted on Aluminum profile rack with sturdy table top flat panel. The process setup consists of supply water tank fitted with pump for water circulation. The level transmitter used for level sensing is fitted on transparent process tank. The process parameter (level) is controlled by microprocessor based digital indicating controller which manipulates pneumatic control valve through I/P converter. A pneumatic control valve adjusts the water flow in to the tank.. Each panel has ABS molded plastic sturdy enclosure with 4mm shrouded connectors showing circuit diagram & its connection tag numbers for easy understanding and connections.

Specifications:

- * Trainer having control panel should provided in 40X40mm Aluminum profile rack with sturdy table top flat panel.
- * Should have ABS plastic panel mounted on the aluminum rack with mimic diagram
- * All input & output are terminated in 4mm shrouded connector, Should provide 4mm banana cable for experiments.
- * Type of control PID
 - Control unit Digital indicating controller
 - Input Type 4-20mA
- * Level transmitter Type Electronic, two wire, Range 0-500 mm, Output 4-20mA,
- * I/P converter Input 4-20mA, Output 3-15 psig
- * Control valve Type Pneumatic, Size 1/2", Input 3-15 psig, Air to close, Char. Linear,
- * Rota-meter 10-200 LPH
- * Pump Fractional horse power, type submersible with Sump Tank
- * Process tank Transparent, Acrylic, with 0-300mm graduated scale
- * Air filter regulator Range 0-2.5 kg/cm²
- * Pressure gauge Range 0-2.5 kg/cm²(1No), Range 0-7 kg/cm²(1No)
- * 230 +/- 10 VAC, 50 Hz, 1 phase with On/Off Switch. Optional: Mini compressor

Experiments

01. Study of open loop (Manual control)
02. Study of on/off controller
03. Study of proportional controller
04. Study of prop. integral controller
05. Study of prop. derivative controller
06. Study of PID controller

Pressure Process Control Trainer

Order Code - 52009E



52009E Pressure control trainer is designed for understanding the basic Level control principles for the Pressure Process control mounted on Aluminum profile rack with sturdy table top flat panel. The process set up consists of pressure vessel fitted with pneumatic control valve. Pressure transmitter is used for pressure sensing. The process parameter (Pressure) is controlled by microprocessor based digital indicating controller which manipulates pneumatic control valve fitted at outlet of pressure tank outlet through I/P converter. Each panel has ABS molded plastic sturdy enclosure with 4mm shrouded connectors showing circuit diagram & its connection tag numbers for easy understanding and connections.

Specifications:

- * Trainer having control panel should provided in 40X40mm Aluminum profile rack with sturdy table top flat panel.
- * Should have ABS plastic panel mounted on the aluminum rack with mimic diagram
- * All input & output are terminated in 4mm shrouded connector, Should provide 4mm banana cable for

experiments.

- * Type of control PID
 - Control unit Digital indicating controller
 - Input Type 4-20mA
- * Pressure transmitter Type Two wire, Range 0-5 bar, Output 4-20 mA
- * I/P converter Input 4-20mA, Output 3-15 psig
- * Control valve Type Pneumatic, Size 1/2", Input 3-15 psig, Air to close, Char. Linear,
- * MS Process tank Pressure vessel with output valve.
- * Air filter regulator Range 0-2.5 kg/cm²
- * Pressure gauge Range 0-2.5 kg/cm²(1No), Range 0-7 kg/cm²(1No)
- * 230 +/- 10 VAC, 50 Hz, 1 phase with On/Off Switch. Optional: Mini compressor

Experiments:

01. Study of open loop (Manual control)
02. Study of on/off controller
03. Study of proportional controller
04. Study of prop. integral controller
05. Study of prop. derivative controller
06. Study of PID controller

Pneumatic Trainer

Order Code - 52010



Pneumatic Trainer explores students & industry professionals to the basic principles of pneumatics and compressed air devices. It tells, how components manage, command, direct or regulates pneumatically. All types of pneumatic controls are explained in the trainer.

Pneumatic Trainer has pneumatic components which can be used for study of Basics of Pneumatics. There is a wide range of experiments which can be performed on the trainer.

- * A complete set up with Air Compressor
- * Mounting panel for Pneumatic components
- * Different pneumatic arrangements; includes Control Diagrams
- * Sequential & Linear Pneumatic Control
- * Understanding of Industrial Pneumatic Components
- * Pneumatic Safety Awareness
- * Exhaustive course material & references

Technical Specifications:

Air Compressor

- Pressure Range : 0 to 150 psi and 0 to 10 Kg/cm
- Supply : 230 VAC
- Motor Type : Single Phase
- Motor Power : 0.5 HP
- RPM : 1440
- Tank capacity : 5 Liters

Components

- Single Acting Cylinder: Stroke length of 54 mm
- 2 Operating Pressure range (0.5 - 8 Kg/cm)
- Diameter - 32 mm

- Double Acting Cylinder : Port size - 1/8 inch
Stroke length of 100 mm
2 Operating Pressure range (0.5 - 8 Kg/cm)
Diameter - 32 mm
Port size - 1/4 inch
- FRL Unit : Operating Pressure 115 psi,
Filter size 25 micron
- 2 Solenoid Valves : 3/2 type, Operating
Pressure range (1.5 - 8 Kg / cm), Operating voltage +24V DC
- 2 Pressure Gauge : Reads (0 - 150 psi and 0 - 10 Kg/cm)
- Manifold : 8 ports
- Panel Dimension : 500 W x 660 D x 15H

Scope of Learning:

01. Study of the operation of a Single Acting cylinder.
02. Study of the operation of a Double Acting cylinder.
03. Observation of the piston movement of a Single Acting cylinder manually by using Push button.
04. To study manual control of piston movement of double acting cylinder.
05. To study of Pilot control of a Single Acting cylinder piston movement.
06. To study of Pilot control of a Double Acting Cylinder piston movement.
07. To study manual sequencing control (A+A-) of double acting cylinder.
08. To study manual sequencing control (+A+B-A-B) of double acting Cylinder.
09. To study manual sequencing control (+A-B+A-B) of double acting cylinder.
10. To study manual sequencing control (-A+B+A-B) of double acting cylinder.
11. To study manual sequencing control (-A-B+A+B) of double acting cylinder.
12. To study combined sequencing of a Single acting cylinder and a Double acting cylinder by using 3/2 solenoid valve.
13. To control the combined sequencing of a Single acting cylinder and a Double acting cylinder by using 3/2 & 5/2 Hand Lever valve.



Double Acting Cylinder



3/2-Solenoid



FRL



5/2-Hand Lever Valve

Temperature Transducer Trainer

Order Code - 52011



Features:

01. Self contained trainers
02. Each with 4 different Transducers
03. Study of Transducer controlled switching / alarm systems
04. On board signal conditioning circuitry
05. Built-in DC power supply
06. Functional blocks indicated on-board Mimics
07. Fully documented Student Workbook and
08. Operating Manual with each trainer

Technical Specifications:

- Transducers : 4 Nos.
 - a. N.T.C. Thermistor
 - b. Platinum R.T.D.
 - c. K Type Thermocouple
 - d. IC Temperature Sensor
- Heating Element : Wirewound resistance 47 W , 10W
- Signal Conditioning Circuitry : 1. Instrumentation Amplifier
2. X100 Amplifier
3. DC Amplifier
4. Comparator
5. Electronic Switch
- Input Circuits : Rotary & Slide Potentiometers
- Output Circuits : 1. Relay
2. Buzzer
- Interconnections : 4mm. banana sockets
- Power Supply : 220 V ±10 %, 50 Hz / 60 Hz on request
- Power Consumption : 2 VA (approx.)
- Dimensions (mm) : W 340 × D 240 × H 105
- Accessories : Line cord, Manual, Set of patch cords.

Experiments :

01. Characteristics of IC temperature Sensor
02. Characteristics of NTC Thermistor
03. Characteristics of NTC Bridge Circuit
04. Characteristics of Platinum RTD
05. Characteristics of K type Thermocouple
06. Temperature Controlled Alarm System

... and many more

Relay Control Trainer

Order Code - 52012



With the rapid progress in computer technology and their applications, these computers can be used as dedicated controllers for a variety of uses: turning on/off lights or other devices around the home, office,

laboratory or factory come to mind. All that is needed is the interface to connect it to the real world. This Kit provides both the hardware and the software to do this. It is a unique Trainer which controls 8 electro-mechanical relays using parallel-port of Personal Computer. The hardware kit plugs in directly to the parallel port of the computer. It carries 8 relays. Each relay is switched on or off by output data (8 bits) sent by parallel port of the computer. The software provides a graphical user interface to control relay operations, their control sequences With LED indication and simulations.

- * Controlling of eight relays (DC 12V) with LED indication
- * Relay control and simulation facility using software
- * Controlling relay sequences using software

Technical Specifications:

- * Eight identical switched relays (DC 12V) O/E/N-58-06-1C
- * Power input positions to the relays using 3 pole terminal blocks
- * DB25 connector to the parallel port of a PC
- * Protection of Parallel port on PC in case of accidental disconnection
- * Diode protection for transistors
- Power Supply : 220 V ±10 %, 50 Hz / 60 Hz on request
- Power Consumption : 2 VA (approx.)
- Relay controlling software -Windows 9x/XPVersion
- Dimensions (mm) :W 440 × D 240 × H 105

Pressure Transducer Trainer

Order Code - 52013



Pressure Transducer Trainer is designed to learn concept of Pressure measurement. It helps students & industry professionals to understand operation of Pressure Transducer in detail. Built-in On/Off Controller is also provided with audio & visual indicators. It also has a PC interface through USB for more interactive understanding of transducer characteristics. User can also take a direct printout if desired. Pressure Transducer Trainer has a wide range of experiments with user friendly software.

Features:

01. Differential Input Pressure Transducer
02. Precise Signal conditioning
03. Self-contained and easy to operate
04. Data acquisition using USB
05. Sensitive, Linear, Stable & Accurate
06. Functional blocks indicated on board mimic
07. On board Digital Voltmeter
08. On board Indicators; Buzzer & LED
09. On board On/Off Controller
10. Graphical representation
11. User friendly software
12. Exhaustive course material & references

Technical Specifications:

- Pressure Transducer : 0 to 100 psi, Differential input
- Pressure Gauge : 0 to 150 psi
- Pressure Vessel : 0 to 100 psi
- Safety Valve : 0 to 100 psi
- Valves : Non-returning valve & Manual vale
- Hoses : 1.5 m
- Foot Pump : 0 to 150 psi
- V-I Specification : 0 to 5 VDC input, 4 to 20 mA output
- Buzzer Indicator : 5VDC
- LED Indicator : 5V DC
- Digital Voltmeter : 0 to 10V
- Test points : 18
- PC Interface : USB
- Power Supply : 220 V+ 10%, 50 Hz

PLC Trainer

Order Code - 52014 to 52016

In today's the importance of PLC has rapidly increased with growing demand for training in this area. The standard packages for PLC are module experiment PCB, power supply, programming and operating software. Optional accessories includes digital and analog expansion modules.



Technical Specifications:

Order Code	52014	52015	52016
Siemens CPU Type	SR20	224	226
Digital Input	12	14	24
Digital Output	8	10	16
Analog adjustments (8-bit resolution)	1	2	2
Program Size (words)	2048	4096	4096
General Purpose Simulation PCB			
Toggle Switches	8	16	24
LED Display	8	12	16

- Internal Memory (bits) : 256 Boolean Execution speed
- Sec. Per instruction : 037ms/ instruction
- PC/PPI Cable Rate : 9.6, 19.2 & 187.5 K baud
- No. Of Ports : 2
- Interface : RS485 & LAN
- Input Voltage : 24VDC
- Output Voltage : 5V DC
- Potentiometer : 4 Nos.

General:

- Power Supply : 220V ± 10%, 50/60Hz, 5VA
- Included Accessories : Programming & Operating software manual, PC/PPI interface cable, Software CD, Softcopy of Siemens Manual
- Optional Accessories : Digital input & Digital

o u t p u t , A n a l o g e x p a n s i o n

- * Micro PLC from Siemens
- * Ladder, L|STL & FBD Languages
- * PC Based programming
- * Ready to use Configuration
- * Programming and operating software
- * Soft copy of PLC introduction and tutorials
- * Choice of PLC and expansion module
- * Expandable input/output
- * Experiment PCB with Switches, LED's and potentiometers
- * Built-in DC power supplies
- * Ready experiments
- * Operating Manual
- * Application Software for car parking, washing machine, Vending Machine, Tank Level Control & Elevator Control

Experiments:

01. Drink Machine. (For cola, lime and lemon)
02. Car Parking. (For three cars)
03. Tank Level Control. (High level, low level and empty)
04. Step Sequence. (Use of timer at different time interval)
05. How to create delays. (Off delay, pulse, extended pulse)
06. Light Intensity variation. (Intensity variation with the help of digital processing)
07. Motor Control. (Stepper motor clockwise anti-clockwise directional control)
08. Digital Electronics Design (combinational, sequential & control logic)
09. Process Control Unit. (B&C)
10. Batch Processing (B&C)
11. Washing Machine
12. Escalator Up
13. Escalator Down
14. Induction Motor Control

PLC Trainer 8 input - 6 output

Order Code - 52017



Features:

01. Micro PLC from Delta
02. On board NO/NC switches
03. Sample of Annunciator given on board
04. Most user friendly, most powerful instruction sets
05. High execution speed
06. PC Based Programming
07. Soft copy of PLC introduction and Tutorials
08. Choice of PLC and expansion module
09. Built-in power supplies
10. Ready experiments
11. Operating Manual

Technical Specifications:

DELTA CPU Type	: DVP-14SS
Digital Input	: 8
Digital output	: 6
Program size	: 3792Steps
Expansion module	: Not expandable
Toggle Switches	: 8

Latch Switches	: 4
LED Display	: 6
Boolean Execution speed	Sec. per instruction : 0.33us / Sequential instruction in average
Interfacing	: RS232
No. of ports	: 1
Input voltage	: 24 V DC
Output voltage	: 5 V DC

General

Power Supply	: 220 V \pm 10 %, 50 Hz / 60 Hz on request
Power Consumption	: 5 VA (approx.)

Included Accessories:

01. Operating Manual
02. Interfacing cable
03. Software CD
04. Soft copy of Manual
05. Patch Cords

PLC Trainer Basic

Order Code - 52017A



52017A PLC trainer basic is designed for understanding the basic PLC programming logic principles for the Process automation, mounted on Aluminum profile rack with sturdy table top flat panel. The PLC setup consists of 8 input & 6 Output with panel. For Simulating input this unit has 6 toggle switch & 2 push switch. For simulating output this unit provided with 8 SPDT relay output with Led indicator. Each panel has ABS molded plastic sturdy enclosure with 4mm shrouded connectors showing circuit diagram & its connection tag numbers for easy understanding and connections.

Technical Specification:

- * Trainer having control panel should provided in 40X40mm Aluminum profile rack with sturdy table top flat panel.
- * Should have 3 ABS plastic panel mounted on the aluminum rack with mimic diagram DVP-14SS2 type PLC Controller panel
 - 32 bit CPU controller built in
 - 8 Digital input ports
 - 6 Digital Output ports
 - Program capacity : 8K step/data register 5K words
 - 4 points of 10Khz pulse output
 - 8 points of high speed counter: 20Khz/4 points & 10Khz/4points
 - Supports modbus, RTU protocol
 - RS-232 link for pc communication
- * Digital Input Simulation panel
 - 6 bit digital input toggle switch provided for Hi & Lo output
 - 2 bit digital input Push switch provided for Hi & Lo output
 - HI output is 24V dc & LO output is 0V.
 - 24V DC supply in built
 - 230V AC power socket with On/Off Switch
- * Digital Output Simulation panel
 - 8 bit SPDT Relay output

- Led indicator for output indication.
- All input & output are terminated in 4mm connector & should provide 4mm banana cable for experiments.

Experiments:

01. Study of NO, NC & Coil Operation
02. Study of Interlock Operation
03. Study of Latch Operation
04. Study of Set & Reset Operation
05. Study of Rising & Falling Edge Operation
06. Study of Timer & Counter Operation
07. Study of Right & Left Shift Operation
08. Study of Addition, Subtraction, Multiplication & Division Operation
09. Study of Data Move Operation

PLC Trainer

Order Code - 52017B



52017B PLC trainer basic is designed for understanding the basic PLC programming logic principles for the Process automation, mounted on Aluminum profile rack with sturdy table top flat panel. The PLC setup consists of 24 inputs & 22 Output with panel. For Simulating input this unit has 14 toggle switch & 2 push switch. For simulating output this unit provided with 8 SPDT relay output with Led indicator. Each panel has ABS molded plastic sturdy enclosure with 4mm shrouded connectors showing circuit diagram & its connection tag numbers for easy understanding and connections.

Specifications:

- * Trainer having control panel should provided in 40X40mm Aluminum profile rack with sturdy table top flat panel.
- * Should have 3 ABS plastic panel mounted on the aluminum rack with mimic diagram
- * DVP-14SS2 type PLC Controller panel
 - 32 bit CPU controller built in
 - 24 Digital input ports
 - 22 Digital Output ports
 - 4 Analog Input channels with 12 bit resolution
 - +/-10V Voltage or +/-20mA current range
 - 2 Analog output channel
 - 0 to10V Voltage or +/-20mA current range
 - Program capacity : 8K step/data register 5K words
 - 4 points of 10Khz pulse output
 - 8 points of high speed counter: 20Khz/4 points & 10Khz/4points
 - Supports modbus, RTU protocol
 - RS-232 link for pc communication
- * Digital/Analog Input Simulation panel
 - 14 bit digital input toggle switch provided for Hi & Lo output
 - 2 bit digital input Push switch provided for Hi & Lo output
 - HI output is 24V dc & LO output is 0V.
 - 4 Analog Simulation Potentiometer.
 - 24V DC supply in built
 - 230V AC power socket with On/Off Switch

- * Digital Output Simulation panel
 - 8 bit SPDT Relay output
 - Led indicator for output indication.
- * All input & output are terminated in 4mm connector & should provide 4mm banana cable for experiments.

Experiments

01. Study of NO,NC & Coil Operation
02. Study of Interlock Operation
03. Study of Latch Operation
04. Study of Set & Reset Operation
05. Study of Rising & Falling Edge Operation
06. Study of Timer & Counter Operation
07. Study of Right & Left Shift Operation
08. Study of Addition, Subtraction, Multiplication & Division Operation
09. Study of Data Move Operation
10. Study of Comparison Operation

Interfacing Simulation Module

- * Traffic Light Module
- * Vehicle Parking Module
- * Elevator Lift Module
- * Washing Machine Module
- * Bottling Plant Module
- * Packing Module
- * Level & Pump Control Module
- * Fan Control Module
- * Star Delta Module
- * Safety Door Module
- * conveyer Belt Module
- * Seven Segment Module
- * Stepper Motor Control Module
- * DC Motor Control Module

Basic PLC Trainer

Order Code - 52017C



Programmable Logic Controllers is a heart of modern automation systems. This theoretical knowledge may not be sufficient for the Industries Technological demands. Today every Engineers needs to undergo the Industrial Automation Training Program. KPC-10 is been design for the engineers to equip the latest Technologies of PLC SCADA/HMI Programming that with the industries standards.

52017C has 2 points 24VDC digital input (4 points 50KHz, 4 points total 5KHz), 6 points relay output or transistor output , 1 communication port with in-built power supply.

Specifications:

- * DVP-14SS2 type PLC Controller panel
 - 32 bit CPU controller built in
 - 8 Digital input ports
 - 6 Digital Output ports
 - Program capacity : 8K step/data register 5K words
 - 4 points of 10Khz pulse output
 - 8 points of high speed counter: 20KHz/4 points & 10Khz/4points
 - Supports modbus, RTU protocol

- RS-232 link for PC communication
- * Digital Input /Output Simulation panel
 - 8 bit Digital input switch for input simulation
 - 5 LED output for output indication
 - 2 pulsar switch for High to low transition
 - 2 pulsar switch for Low to High transition
 - Capacitive Type, Inductive Type & Photo pickup Type Proximity Switch.
 - High output is 24V dc & Low output is 0V.
- * On-board application
 - RYB Pilot Lamp, Relay, Buzzer, DC Motor.
 - 24V DC supply in built
 - 230V AC power socket with On/Off Switch
- * All input & output are terminated in 2mm connector & should provide 2mm banana cable for experiments.

Experiments:

01. Study of NO, NC & Coil Operation
02. Study of Interlock Operation
03. Study of Latch Operation
04. Study of Set & Reset Operation
05. Study of Rising & Falling Edge Operation
06. Study of Timer & Counter Operation
07. Study of Right & Left Shift Operation
08. Study of Addition, Subtraction, Multiplication & Division Operation
09. Study of Data Move Operation

Industrial PLC Trainer

Order Code - 52018 - 52019



PLC Trainer is an ideal tool to study the working of PLC's used for industrial applications. The trainer has been designed to demonstrate the application of PLC in the area of 1. Wiring of PLC with different inputs and outputs. 2. Switches like Latch, NO/NC toggle, NO/NC IR can be connected as an input to the PLC. 3. PLC can drive annunciator which has valves, motor, pump, visual indicator and audio indicators according to the input of PLC.

Features:

01. Micro PLC from Fatek
02. On board NO/NC switches
03. On board IR switches
04. Sample of Annunciator given on board
05. Most user friendly, most powerful instruction sets
06. PC Based Programming
07. Soft copy of PLC introduction and Tutorials
08. Choice of PLC and expansion module
09. Built-in power supplies
10. Ready experiments
11. Operating Manual
12. Ready to use Application boards

Technical Specifications:

Order Code	52018	52019
FATEK CPU Type	FBs-14 MA	FBs-20 MA
Digital Input	8	12
Digital output	6	8
Program size(Words)	2048	4096

Expansion module	Not expandable	Expandable
General Purpose Simulation PCB		
Toggle Switches	3	3
Latch Switches	3	3
IR Switches	2	2
LED Display	7	7
Boolean Execution speed Sec.		
per instruction	: 0.33 is/Sequential	
instruction	in average	
Interfacing	: Rs232,	
No. of ports	: 1, Input voltage : 24 VDC	
Output voltage	: 5 VDC,	

General :

Power supply	: 220 V ±10%, 50 Hz / 60 Hz on request ,
Power Consumption	: 5 VA(approx.)

Included Accessories :

01. Operating Manual.
02. Interfacing cable.
03. Software CD.
04. Soft copy of FATEK Manual.
05. Patch Cords.
06. Optional Accessories: Analog expansion module (4 inputs and 2 outputs).

Water Level Control

Order Code - 52021



Water level control enables students and practicing engineers to gain invaluable practical experience of the principles and application of programmable logic controllers. The object is to connect and program an external programmable logic controller to monitor and control the level of water in a tank system. Water level controlling is shown with the help of LEDs. The apparatus is connected with output of PLC. Two valves for filling and draining water are shown, for indicating ON\OFF condition of valve LED is used. Filling of tank indicated by two sensors, positioned to sense maximum and minimum water levels of tank.

Technical Specifications:

Interface	: 20 pin FRC cable needed with PLC (To work with 52014,52015, 52016 PLC Trainer Only)
Input pin voltage	: 24 V DC when particular i/p is activated from PLC
Output pin voltage	: 5 V DC when particular o/p is activated from PLC
Power supply	: From PLC Trainer

Elevator Control By PLC

Order Code - 52022



Elevator Control by PLC enables students and practicing engineers to gain invaluable practical experience of the

principles and application of programmable logic controllers. The object is to connect and program an external programmable logic controller to monitor and control elevator system. Elevator controlling model is shown with the help of switches & LEDs. The apparatus is connected with input and output of PLC. Three floors as shown on board, switches are used to call and go to the desired floor. LEDs are indicating on which floor the elevator is present. The elevator model board is made in such a way that student can understand how elevator can be control by using PLC and also student gets familiar with how inputs and outputs of PLC are used

Technical Specification:

- Interface : 20 pin FRC cable needed with PLC (To work with 52014,52015, 52016 PLC Trainer Only)
- Input pin voltage : 24 V DC when particular i/p is activated from PLC
- Output pin voltage : 5 V DC when particular o/p is activated from PLC
- Power supply : From PLC Trainer

Traffic Light Control By PLC

Order Code - 52023



52023 Traffic light control enables Students and practicing Engineers to gain invaluable practical experience of the principles and application of Programmable Logic Controllers.

The objective is to connect and program an external Programmable Logic Controller to monitor and control a traffic light system.

Traffic light controlling is shown with the help of LEDs. The module is connected with output of PLC. Four way traffic is automatically controlled by PLC roads which meeting at a circle.

Object:

01. Study of traffic light.
02. Study and use of memory bit and timers.
03. Traffic light control by PLC through ladder program
04. Study of signal indications for two direction.

Feature:

01. User friendly and powerful instruction sets.
02. Ready to use application board.
03. Exhaustive learning material

Technical Specifications:

- Interface : 20 pin FRC cable with PLC (52014, 52015, 2016)
- Input pin voltage : 24 V DC when particular i/p is activated from PLC
- Output pin voltage : 5 V DC when particular o/p is activated from PLC
- Power Supply : From PLC
- Dimension (mm) : W340 x H125 x D210
- Weight : 0.7Kg (Approximately)
- Operating Condition: 0 - 400C, 85% RH

List Of Accessories:

01. 20 Pin FRC cable01Nos.

Traffic Light Control By PLC

Order Code - 52024



52024 Traffic light control enables Students and practicing Engineers to gain invaluable practical experience of the principles and application of Programmable Logic Controllers.

The objective is to connect and program an external Programmable Logic Controller to monitor and control a traffic light system.

Traffic light controlling is shown with the help of LEDs. The module is connected with output of PLC. Four way traffic is automatically controlled by PLC roads which meeting at a circle.

Object:

01. Study of traffic light.
02. Study and use of timers.
03. Traffic light control by PLC through ladder program
04. Study of all three signals Red, Green and Orange i.e. Ready, go and stop. Having signal indications for all direction at any square.

Feature:

01. User friendly and powerful instruction sets.
02. Ready to use application board.
03. Exhaustive learning material

Technical Specifications:

- Interface : 20 pin FRC cable with PLC (52014, 52015, 2016)
- Input pin voltage : 24 V DC when particular i/p is activated from PLC
- Output pin voltage : 5 V DC when particular o/p is activated from PLC
- Power Supply : From PLC
- Dimension (mm) : W340 x H125 x D210
- Weight : 0.7Kg (Approximately)
- Operating Condition: 0 - 400C, 85% RH

List Of Accessories:

01. 20 Pin FRC cable01Nos.

Conveyor Control by PLC

Order Code - 52025



Conveyor Control by PLC enables students and practicing engineers to gain invaluable practical experience to understand the use of Conveyors and its control using PLC in the process industries. The object is to connect and program an external PLC (Programmable Logic Controller) to monitor & control a process which uses a conveyor.

It is a single stage unit having a conveyor along with mounting assembly of two sensors. Two types of boxes travel on conveyor one is of metal & other is of non-

metal, one sensor is for counting & other is for detecting the type of box. Unit has inputs to PLC like On/Off, auto/manual control and some extra inputs are also given. Similarly the outputs of PLC are available on the panel. One buzzer is also given as annunciator. Note: It can only be used in combination with PLC Trainer 52014, 52015, 52016 and 52018, 52019.

Features :

- 01. Real time conveyor control by PLC
- 02. Product sorting
- 03. Works on both Auto/Manual mode
- 04. Provision for user to expand the number of sensors
- 05. Exhaustive course material & references
- 06. Optional application boards

Technical Specifications :

- Digital Input pin voltage :
 - + 24 V DC when particular I/P are activated for PLC (To work with 52014, 52015, 52016 52018, 52019)
- Digital Output pin voltage :
 - + 5 V DC when particular O/P is activated from PLC (To work with 52014, 52015, 52016 52018, 52019)
- IR Sensor : + 24 V DC output
- Proximity Senso : + 24 V DC output
- DC Motor : + 5 V DC
- Toggle Switches : Two
- Latch Switches : Two
- Power Supply : From PLC trainer (+ 24 V DC & + 5 V DC)
- Interface : 2mm patch cords needed along with PLC trainer

PID Controller Trainer

Order Code - 52026



In control system there are different types of controller. Study of two-position mode as ON/OFF controller and continuous controller modes as PID controller is a very important part of control engineering. To have a basic idea and practical hands on controllers our PID Trainer has been designed to be used by student to investigate the fundamental principles of PID by applying different signals to it.

With PID controller trainer student can study two position mode as ON/OFF controller and continuous controller modes as P-control mode, Icontrol mode, D control mode, PI-control mode, PD - control mode and PID control mode. This modes of controller can be performed individually and also with different combinations in open loop and close loop system. With this trainer user can easily understand the difference between the different modes of controllers used. Square wave, triangular wave generator and variable DC supply as set point is given on board and disturbance generator is provided. Effect of PID can be seen on first order system and second order system in open loop and close loop system, which is given on the

board.

Features:

- 01. Proportional, Integral and Derivative functions can be checked on same board (configurable as P,I, D, PI, PD, PID)
- 02. ON/OFF controller
- 03. Square and triangular wave with variable frequency for testing PID
- 04. Variable DC for set point
- 05. Error detector
- 06. Ist order system & IInd order system
- 07. In built power supply
- 08. Dead zone and disturbances generator
- 09. Built-in 3½ DVM for DC measurement
- 10. Test point at varies block to measure and observe the signals.
- 11. Manual describing working of trainer along with detailed experiment descriptions

Technical Specifications:

- Proportional Band : 5% to 55%.
- Integrator : 10 msec to 110 msec
- Derivative : 1 msec to 11 msec
- ON/OFF controller : ON = 12 V, OFF = -12 V
- On board Generator : Square wave & triangular wave
 - Generator of 0 -156 Hz, Two Variable DC +6 V,+10 V
- Interconnections : 2 mm socket
- Power Supply : 220 V ±10 %, 50 Hz / 60 Hz on request
- Power Consumption : 1.6 VA(approx.)

Digital Control System

Order Code - 52027



- * Digital Controller implementation on mP - kit
- * Simple Op-amp based analog plant
- * CRO display of response
- * Design and test new algorithms

industrial processes has become very important today because of the advantages it offers and the increased availability of inexpensive computing power of microprocessors. The principal advantages include fixed hardware with complete software flexibility and the feasibility of complementing integration and differentiation on extremely slow varying signals. On the other hand digital controllers have some drawbacks also such as errors due to the processes of sampling and reconstruction, computational errors caused by finite wordlength, truncation, register overflow, as well as the de-stabilisation effects of sampling. A clear understanding of all these aspects is of great value to a student of control engineering. In the present unit a second order transfer function, simulated with operational amplifiers and passive components, has been chosen as the process to be controlled. This results in a well behaved and near perfect linear process which gives a highly predictable performance and enables the student to concentrate on the design and evaluation of the controller. The digital controller

consists of a 8085 based microprocessor Kit with analog-to-digital and digital-to-analog interface. The dynamic ranges of the variables in the whole system and that of the built-in square wave test input signal are made compatible. The step response may be displayed and studied using an external measuring CRO. Software supplied with the system resides in a 8K EPROM. This consists of P, P-I and P-I-D algorithms in which the three gains may be selected out of 16 levels each. All arithmetic calculations are performed in 16-bits and are also available to the user as subroutines. Detailed information and listing of the software is included in the literature, besides suggestions and procedures for conducting experiments. Also included are typical results of some experiments with their theoretical descriptions. Further, the user may write his own programs to implement additional algorithms and study their responses .

Experiments:

- 01. Identification of the controlled process
- 02. Study of sampling period variation
- 03. Designing P, PI, PD and PID controllers
- 04. Advanced algorithms implementation

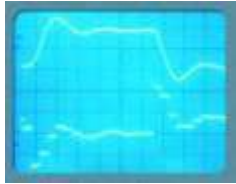

System output and error

AC Servomotor Study

Order Code - 52028



- * Torque computation through electrical loading
- * Determination of motor parameters - inertia and friction
- * Digital display of time constant
- * Transfer function evaluation

Introduction:

Two phase a.c. servomotor is one of the very important electromechanical actuators having applications in the area of control systems. The study of its operating principle and features form a part of the first course on automatic control systems in electrical engineering curriculum. It's small size, low inertia and almost noise and frictionless operation makes the a.c. servomotor particularly attractive in aircraft and spacecraft applications.

The characteristics of an a.c. motor is usually non-linear. To simplify the analysis a linearized model is developed. The experimental work revolves around determination of the parameters of the motor and thus its transfer function.

Important subsystems of the unit includes,

- (a) an integrated speed sensor with 4-digit display in r.p.m.
- (b) an electrical loading system to compute torque
- (c) a time-constant measurement circuit with 3-digit display in milli seconds

- (d) a three step a.c. source with built-in r.m.s. voltmeter, and
- (e) a digital voltmeter on the panel for load measurement

The unit has been designed such that expensive equipment like storage CRO is not needed. Also the hassle of direct torque measurement using spring balance etc. is avoided by linearization of the motor characteristics analytically.

Experiments:

- 01. Inertia and friction parameters
- 02. Time constant
- 03. Transfer function

Features and Specifications:

- 01. 2-phase a.c. servomotor - 12V/ 50Hz per phase
- 02. Small generator for loading
- 03. 4-digit speed display
- 04. 3-digit time constant display
- 05. 3½ digit r.m.s. voltmeter
- 06. 3½ digit d.c. panel meter
- 07. Voltage regulated internal supplies
- 08. Detailed literature with sample results

DC Motor Study

Order Code - 52029



- * Torque-speed characteristics
- * Determination of motor parameters - inertia and friction
- * Digital display of time constant
- * Transfer function evaluation

Introduction:

A d.c. motor is commonly used as an actuator in many industrial control applications because of its features - large torque and ease of speed variation. The dynamic characteristics of such a system therefore depends on the motor parameters viz., Moment of inertia, coefficient of friction, time constant and als the resistance and inductance of the control winding. It is therefore important to experimentally determine the mechanical and electrical parameters of the d.c. motor and also to evaluate its transfer function.

The present unit is designed to study a small permanent magnet d.c. motor. A still smaller generator directly coupled to the motor is used for the dual purposes of speed signal pick up and providing electrical loading. The shaft speed in rpm is displayed automatically on a 4-digit panel meter.

When the motor is suddenly switched ON a novel circuit computes and displays the time constant in milliseconds on a 3-digit panel meter. This avoids the need for an expensive storage CRO. The motor unit is housed in a cabinet with transparent panels, providing a good view of the mechanical system.

Experiments:

- 01. Torque-speed characteristics
- 02. Inertia and friction parameters

03. Back e.m.f. constant
04. Time constant
05. Transfer function

Features and Specifications:

01. Study of a 12V, 8W d.c. motor
02. Small generator (2W) for speed pick up and loading
03. 4-digit speed display
04. 3-digit time constant display
05. 3½ digit voltmeter and current meter for d.c. measurement
06. IC regulated power supply
07. Supporting literature with experiment details

DC Position Control System

Order Code - 52030



- * Compact system - no mechanical hassles
- * Simplified operation
- * mP based storage of response
- * mPositive/ Negative tachogenerator feedback

Introduction:

One of the most common examples covered in text books and literature on linear systems is a d.c. position control system. This system is easily understood and has a second order transfer function in the standard form, for which a well developed theoretical treatment is available.

This unit provides the students an opportunity to study and operate a practical electromechanical angular-position-control system. The system is built around a good quality permanent magnet armature-controlled d.c. motor, speed reduction gear-set, potentiometric error detector using special 360° revolution servo potentiometers, a tachogenerator for velocity feedback and associated electronic circuits. Unlike simulated systems, e.g. our LINEAR SYSTEM SIMULATOR, the position control system naturally consists of non-ideal parameters viz. saturation of amplifier and motor current, dead zone and backlash, nonlinearity in the motor and gears, imperfections in mechanical fabrication and somewhat uncertain order of the complete system due to filters, various time constants and load parameters. Experimental work on this system would enable the students to appreciate the difference in performance between idealized systems studied in the theory classes and the systems encountered in practice.

A difficulty which is faced while working with many practical control systems is that their responses are rather slow (Note that in a simulated system the common practice is to scale-up the frequency to ensure a proper viewing on a CRO). A storage CRO or an X-Y plotter is therefore required for studying the waveforms. Both these instruments are too expensive and/or delicate, and are therefore not usually available to the undergraduate students in most institutions. The present unit has a built-in mP based waveform capture/display system which stores the step response of the control system in a RAM and then displays it on a

measuring CRO for further studies. This arrangement is extremely simple to operate and conforms to the accuracy needs of a class room experiment. The motor unit is housed in a separate cabinet with transparent panels for easy viewing. Interconnection with the main unit is through a standard 9-pin D-type connector. All power supplies and step input signal are internally provided. In addition a 3½ digit DVM is available on the panel for the measurement of various signals. A good quality measuring CRO is the only accessory that would be required.

Experiments:

01. Operation of the position control system for different values of the forward gain to angular position commands
02. Step response studies for various values of forward gain
03. Study of the effect of velocity feedback on the transient and steady state performance of the
04. system as well as its stability

The experiments would involve calibration and operation of the waveform capture/display section as a first step. It may be mentioned here that due to the non-linearities and other imperfections and uncertainties existing in a physical system of the present type, a quantitative verification of the results with theoretical analysis is not recommended. This is best done on a simulated system. Of course the experimental work does include determination of rise time, overshoot, steady state errors etc. for various conditions for an evaluation of the system performance.



Oscillatory response

Features and Specifications:

01. Position control of a 12V, 1A d.c. gear motor (50 rpm)
02. Provision for positive and negative tachogenerator feedback
03. Tacho constant: 2V/1000 rpm approximately
04. Calibrated dials for reference and output position: resolution 1°
05. Servo-potentiometers with full 360° rotation
06. mP based waveform capture/display card
07. Built-in 3½ digit DVM for signal measurements
08. Built-in step signal and IC regulated power supplies for electronic circuits
09. Separate unit for motor in a see-through cabinet 220V±10%, 50Hz mains operation
10. Literature and patch cords included
11. Essential accessories - a CRO



A.C. Position Control System

Order Code - 52031



- * 2-phase A.C. Servomotor
- * Servo Potentiometer for position sensing
- * Transient response capture/display
- * In-built rms voltmeter on panel

Introduction:

2-phase ac servomotors have been traditionally used for position/ speed control applications especially in light weight, precision instrumentation area in airborne systems. The present unit is designed around a 12V ac servomotor and exposes the basic characteristics and dynamics of a position control system. A block diagram of the system is shown in figure below. Besides introducing the basic features like balanced modulation of the error signal, phase reversal around the set point and phase difference between the reference and control phases of the motor, the experiment involves study of the step response of the closed loop system. Being a mechanical system the response is too slow for a comfortable viewing on a CRO, except on an expensive storage oscilloscope. A microprocessor based waveform capture/ display card in the unit stores the step response in real time and displays the same once steady state is reached.

Experiments:

01. Error detector characteristics, phase reversal
02. Amplifier gain measurement
03. Phase difference between control and reference windings
04. Step response study

Features and Specifications:

01. 2-phase servomotor 12V/ phase, 50Hz, 10W
02. Power amplifier for driving
03. Servo potentiometer type error detector
04. In-built 10.00V (rms) panel meter
05. Step response capture/ display card
06. Detailed literature with typical results included
07. Complete unit except a measuring CRO

DC Speed Control System

Order Code - 52032



- * Closed loop motor speed control with eddy current brake
- * Compact system-no mechanical hassles
- * Opto electronic speed sensor
- * Digital display of speed on the panel

Introduction:

Accurate speed control is a requirement in many industrial and process control systems. The main characteristics of such a system are its steady state error and disturbance rejection properties. Speed

control of a d.c. motor is also one of the basic systems covered in a first course on automatic control system. The present unit, built around a small permanent magnet d.c. motor, is designed to bring out the salient features of such a system. Facilities are available to directly measure the principal performance factors of the speed control system, viz., steady state error and load disturbance rejection, as a function of the forward path gain. In addition, the experimental work involves the determination of the motor transfer function and the characteristics of the tachogenerator.

An important feature of the unit is the built-in absolute speed measurement through optical pickup from a slotted disk followed by a frequency counter. The 4-digit speed display is therefore completely independent of the tachogenerator characteristics. The high accuracy of speed reading is due to a built-in crystal oscillator. Another interesting design feature is the use of an 'electronic tachogenerator' - a frequency to voltage converter, for the generation of speed feedback signal. This highly linear, non-contact transducer is ideally suited for the small d.c. motor being used in the unit. Variable loading of the motor is achieved by a built-in eddy current brake. This brake has superior characteristics compared to friction brake especially for a small motor. The motor unit, housed in a cabinet with transparent panels, provides a good view of the mechanical arrangements. In addition, a 3½ digit DVM is available on the panel for the measurement of various d.c. Signals. A measuring CRO is the only accessory that will be required for conducting the experiments.

Experiments:

- * Effect of loading on the speed of the motor in the open loop
- * Steady state error variation with forward gain

Features and Specifications:

- * Speed control of a 12V, 4W permanent magnet d.c. motor
- * Speed range: 0 to 3000 rpm (typical)
- * Opto-interrupter based speed sensing
- * 4-digit speed display in rpm
- * Electronic tachogenerator for feedback
- * Separate unit for motor in a see-through cabinet
- * System time constant variation with forward gain
- * Effect of forward gain on disturbance rejection
- * Determination of the motor transfer function and
- * Smooth, non-contact eddy current brake for loading
- * Built-in 3½ digit DVM for signal measurements
- * Built-in IC regulated internal power supply
- * 220V±10%, 50Hz mains operation
- * Supporting literature and patch cords included
- * Essential accessory a CRO

Schematic Diagram



Temperature Control System

Order Code - 52033



- * Fast compact oven upto 90°C
- * Forced cooling option
- * Variety of control actions
- * Digital temperature readout
- * Built-in timer, 0-9999 sec.
- * Solid state temperature sensor

Introduction:

Temperature control is an important application of control theory to industrial processes. This experiment has been designed to expose the students to such a practical control system, its various stages for control, and the tuning of a PID controller. The process consists of a small and fast responding oven which can be controlled in the temperature range from ambient to about 90°C. Temperature readings may be taken manually on a 3½ digit meter, mounted on the main unit, at regular intervals. A built-in digital timer having 'START', 'STOP' and 'PAUSE' switches on the panel makes the conduct of an experiment very simple. This design of the oven avoids expensive accessories like an X-Y recorder for conducting the experiment. A forced cooling arrangement has been provided to bring the oven temperature down to room temperature after every experiment. Since the oven may be cooled to the ambient relatively speedily, a number of cycles of experimentation are possible in the usual laboratory hours. The oven is connected to the main unit through a four pin connector, two for the sensor output and the others for controller output to the heater. The main unit has provisions for configuring any type of controller such as P, PI, PD, PID or ON-OFF, and has potentiometer controls for PID coefficient settings. All supplies and metering system are built-in and no accessories are required.

Open loop response of the oven is obtained by applying a step command with feedback disconnected. Temperature readings are noted and the plot so obtained provides the characteristics of the oven, i.e., its time constant and time delay.

The simplest form of controller is a relay which switches the oven ON and OFF. Presence of hysteresis is essential for avoiding excessive relay switching, of course at the cost of accuracy. The performance is studied here for the two hysteresis settings of the builtin 'electronic relay'.

PID controllers may be set or tuned by many different methods. In this experiment the design method of Ziegler-Nichol is suggested for setting the coefficient potentiometers and the resulting response curve is studied. Other methods may also be used equally easily.

The literature accompanying the unit describes in detail the mathematical concepts, procedure for experiments and a few test results. A number of additional experiments may also be planned by the teacher using books and literature on this subject which is suggested in the references given.

Experiments:

01. Identification of the oven parameters
02. Study of P, PI, PD and PID controls having
03. Study of ON-OFF temperature control (with
04. adjustable coefficients tachometer characteristics
05. adjustable relay characteristics)

Features and Specifications:

01. Temperature controller with facilities for P, I, D and relay control blocks
02. Operating temperature: Ambient to 90°C
03. Separate controls for P, I, D channel gains
04. Two settings for relay hysteresis
- Fast 25W oven fitted with IC temperature sensor
05. Forced cooling option to ready oven for next experiment
06. Digital display of set and measured temperature on a 3½ digit built-in DVM
07. 0-9999 sec, timer on panel for a convenient temperature response experiment
08. Buffered output for recorder
09. IC regulation in controller circuit power supplies
10. 220V±10%, 50Hz mains operation
11. Supporting literature and patch cords included
12. No accessories required

Schematic Diagram

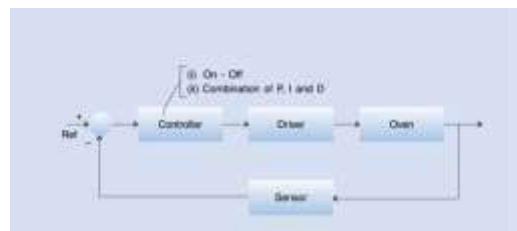

Temperature Sensor Trainer

Order Code - 52033A



Measurement of temperature is an important task in a large number of physical processes. A transducer in a device which converts the temperature information into an electrical signal, usually voltage, for an automated processing. A very wide variety of temperature transducers are commonly available which differ from each other with regards to there:

- Range of operation - Sensitivity and linearity
- Accuracy, Stability and Repeatability
- Speed of response

The present experiments has been designed to study the input output characteristics of some common transducers like, thermistors NTC type, K-type thermocouple, Platinum type Pt100, semiconductor sensors and may be extended to also study the temperature coefficients of resistances.

The main requirements for an experiment of this nature are,

- A) A precisely controlled from oven with a temperature display which is fast
- b) An adjustable gain instrumentation amplifier which may be used to amplify the different levels of signals from transducers

- C) Interfacing circuits suitable for the transducers used.

Features

01. Study of 4 different temperature transducers - NTC thermistors, RTD Platinum, K(Cr-Al) thermocouples, IC temperature sensors.
02. Study & comparison of Temperature transducer controlled alarm system.
03. PID control: P, P+I, P+D & P+I+D control action
Instrumentation amplifier, adder amplifier : X1 , X100, X235, P controller , I controller, D controller
Comparator Electronic switch, Signal conditioning, Rotary / Slide pots , Heater, Relay, Buzzer, LED
04. Digital meter : Actual/Set temp/mV
05. Interconnections
- All interconnections are made using 2mm banana Patch cords.
06. Test points are provided to analyze signals at various points.
07. All ICS are mounted on IC Sockets.
08. Bare board Tested Glass Epoxy SMOBC PCB is used.
09. In-Built Power Supply with Power ON indication.
10. Attractive ABS Plastic enclosures.
11. set of 2mm Patch cords for interconnections
12. User's Manual.

List of Experiment:

01. Study the NTC Thermistor sensor.
02. Study the Platinum RTD sensor.
03. Study the K-type Thermocouple Temperature sensor.
04. Study the IC LM335 type Temperature sensor.

PID Controller Trainer

Order Code - 52034



- * PID - action study on CRO
- * Simulated blocks for flexible system
- * Time delay (transportation lag) block
- * Synchronised square and triangular source for flicker free display

Introduction:

Proportional-Integral-Derivative (PID) control has been especially popular in industrial processes like chemical, petroleum, power, food and manufacturing industries. These systems are usually slow, complex and are characterised by relatively incomplete or uncertain mathematical description. The PID controller, parameters of which may be adjusted experimentally, is therefore particularly attractive in such situations. The experimental unit consists of simulated building blocks like error detector, dead time, integrator and time constants, which may be configured into a variety of systems. A PID section with adjustable proportional gain, derivative and integral time constants provide the control action. Built-in set value, square and triangular sources enable the students to study the response on a CRO. The accompanying literature includes system description, theory, experimental procedure and typical

results. An important feature of the system is that the simulated blocks are designed to operate at frequencies suitable for CRO viewing. The effect of controller parameter adjustments are therefore seen immediately. No expensive recorders are required for conducting the experiments.

Experiments:

01. Open loop response of various process configurations (10 in all)
02. Study of closed loop response for above
03. P, PI, PD and PID design and performance evaluation in each case



Response of PID block



Time delay display

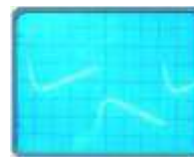

Well adjusted PID response



X-Y display

Schematic Diagram

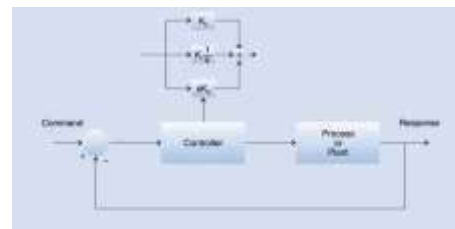

Study of Synchro Devices

Order Code - 52035



- * Synchro transmitter-receiver pair with calibrated dials
- * Locking system for receiver rotor
- * Receiver use as control transformer
- * Built-in balanced demodulator circuit
- * Panel meter for ac/dc voltages
- * All internal power from the 220 V/50 Hz mains
- * Only an external CRO required

Experiments:

01. Basic characteristics study - stator voltages as a function of the rotor angle using the built-in ac voltmeter. This shows the space variation of the three voltages, VS1S2, VS2S3, and VS3S1, causing rotation of the resultant magnetization in the stator which is fundamental to the error detection process.
02. Operation and error study of the transmitter-receiver pair as a simple open loop position control at a very low torque. This is a rarely used application but is used to demonstrate the

Direction of the resultant magnetic field in the receiver.

03. Plotting the error voltage output as a function of the transmitter rotor angle with the receiver rotor locked. Observing the 180° phase reversal around the zero error is significant as this the basic method through which the direction of the error is detected in an ac system
04. Use of balanced demodulator to develop dc error signal with appropriate polarity and compare it with the ac error. This block would be needed if a mixed system were to be designed using both dc and ac components.

Typical Results

a) The plot of the three stator voltages, VS1S2, VS2S3, and VS3S1 as a function of rotor angle are usually shown as

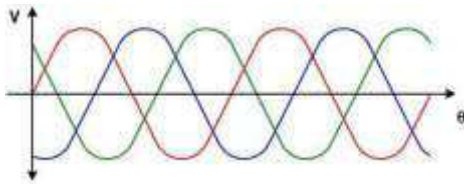

It should be of interest to visualize why the ac voltages are also plotted as negative values!

b) The error voltage plot is of the form as under

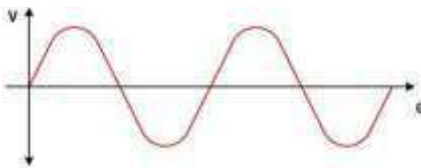

Observe that the input-output characteristics of the synchro error detector is distinctly non-linear. How is it used in a linear system should be of interest.

Schematic Diagram

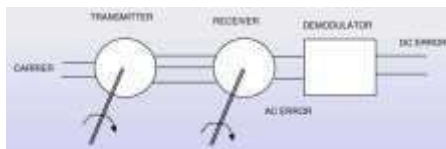

Linear Variable Differential Transformer

Order Code - 52036



- * Large size LVDT for class room
- * Transparent casing for proper viewing
- * AC and DC output
- * Slow motion displacement

Introduction:

A Linear Variable Differential Transformer (LVDT), is a transducer for linear displacement measurement. Using suitable accessories, the LVDT can be used for pressure measurement, weight measurement, liquid level sensing etc. The principal features of LVDT are its good linearity and high sensitivity in a large range.

The present experimental unit comprises of a LVDT in a transparent box with lead screw based slow motion displacement, a mm scale for displacement measurement, and main unit consisting of excitation signal source, balanced demodulator, a 3½ digit DVM and necessary power supplies. The signals are provided to the LVDT box through a cable from the main unit.

The unit is supplied with a detailed user manual which explains the theoretical background alongwith procedures for conducting the experiments and tabulating the results. Some typical results and references are also given.

Experiments:

- * Variation of modulated output with displacement
- * Input - Output characteristics
- * Determination of linear range and transducer gain

Features and Specifications:

01. LVDT
Range: ±50mm or total 100mm (typical)
Sensitivity : 25mV/cm (typical)
Operating frequency : 5KHz±5%
02. Displacement measurement on a mm scale with fine motion control
03. Carrier source (internal): 5KHz±5%; 1.5V (nominal)
04. Built-in 3½ digit DVM for output reading IC based balanced demodulator circuit
05. IC controlled internal power supplies
06. 220V±10%, 50Hz mains operation
07. Essential accessory a CRO



Mechanical Unit

Study of Magnetic Levitation System

Order Code - 52037

- * Object suspended in air by magnetic force excellent visual impact
- * Controller design to maintain stability
- * Up-down position setting by reference control

Description:

Magnetic Levitation, lifting of objects under the influence of a magnetic field, has numerous application including designed on the responsive force of a magnetic.

The present unit, base on the attractive force of an electromagnet, is inherently unstable. There is no way to keep an iron object suspended in air by manually adjusting the current in the electromagnet. Even a feedback control with forward path gain control alone is ineffective. These facts are brought out by studying and experimenting with the dynamic of the system. The next task consists of the design of suitable controller and implementing the same to achieve the desired objective. A sound knowledge of MATLAB and its availability should be highly desirable, though not essential, for the conduct of this experiment.

The basic theory, analysis and sample calculation are described in the accompanying literature.

Experiments:

01. To develop the transfer function of the system through laboratory
02. To design/implement PD and lead compensation with different parameter
03. To simulate the system in MATLAB and study in detail various control option and their response.

Features and Specifications:

01. Object suspended in air by magnetic force
02. Controller design to maintain stability
03. Position changing by reference
04. Built-in power supplies, meters etc
05. 220V/50Hz operation
06. Detailed technical literature included

Stepper Motor

Order Code - 52038



- * Stepper motor operation through pulse circuit
- * Stepper motor operation through 8085 kit
- * Built-in programs in EPROM
- * Dynamic response study

Introduction:

With the rapid advancement in digital electronics, the stepper motor by virtue of its being a direct digital actuator, has become an important element of a control system. Well known applications include watches, floppy and hard disk drives, printers etc. This experimental set-up aims at providing an exposure to the basic operation of a stepper motor, its drive and logic, and limitations as far as the internal dynamics is concerned. Experiments have been designed to demonstrate the effect of external load inertial and frictional, on the motor performance. Provisions are available for free running operation as well as single stepping mode with LED indication for the active phase. The unit may also be operated by a microprocessor kit for which a built-in interfacing and automatic changeover has been provided. It may be seen that this is a complete experiment set and not a microprocessor kit with an ADD-ON card and a motor.

An exhaustive literature is supplied with the unit explaining in details the theory of stepper motors, procedure for conducting the experiments and interpretation of the results. The details of application software are also included.

Experiments:

01. Study of manual stepping through push button switch - it would enable the student to appreciate one to one correspondence between the number of steps and shaft movement. A 360° calibrated dial is used for the measurement of step angle
02. Study of speed and direction control logic by recording the pulse sequence for both clockwise and counter clockwise motions
03. Study of resonance effect at various speeds - it provides an idea of the dynamic behaviour of the motors
04. Display and measurement of the dynamic characteristics of the motor on the CRO while the motor is given a to-and-fro motion in the wobble

mode. This enables one to calculate 'single stepping' and 'slew' regions

05. Programming the microprocessor kit to implement various features like direction, speed, prescribed angle of rotation, prescribed number of steps or an arbitrary motion
06. Application software is included for demonstration and also for use as a set of subroutines
07. Study of the effect of inertial and frictional loading on the dynamic performance

Features and Specifications:

01. Single stepping and free running modes of operation with speed variation and direction reversal - internal TTL circuit.
02. 360° motion Servo-Potentiometer position-pickup for motor dynamics
03. Operation through microprocessor kit sample control programs provided
04. Stepper motor specification
Torque: 2.8 Kg-cm
Step angle: 1.8°
Power: 12V, 1A/phase
05. 220V±10%, 50Hz mains operation
06. Complete in all respects, except a measuring CRO

Technical Specifications of the μ P Kit Supplied

01. High performance 8085A CPU operating at 3MHz
02. 4K powerful monitor FIRMWARE in 2732. Includes all standard commands, codes, functions and utility sub-routines
03. 4K user RAM 6116
04. Versatile Keyboard/Display controller using 8279
05. Serial I/O lines, 22 parallel lines from 8155 and 24 from 8255
06. Built-in audio cassette interface
07. 6 digit seven segment LED display
08. Power Supply: Built-in in the Stepper Motor Unit



Phase voltages of two phases



Dynamic Response



Motor unit

Schematic Diagram

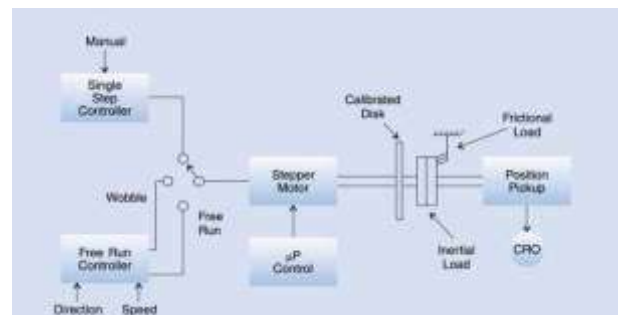

Relay Control System

Order Code - 52039



- * System with electronic relay
- * Adjustable hysteresis and dead zone
- * Display phase plane diagram on CRO
- * Stability study by describing function method

Introduction:

Most physical systems are nonlinear to some extent, however, for purpose of analysis and design these are taken as nearly linear. In a few systems nonlinear elements are deliberately introduced to get some specific advantage. One such system is a relay control system, often referred to as bangbang or ON-OFF system. The controller in such a system is replaced by a power relay resulting in a substantial cost reduction. In the present unit a simulated second order system is controlled by an electronic relay. Apart from a study of the relay characteristics the experiment introduces the concept of Describing Function. Finally the phase plane method of analysis is covered in detail where the switching trajectories can be displayed on an X-Y oscilloscope. Figures below give the block diagram of the feedback system and the characteristics of the simulated relay.

The accompanying literature covers a brief treatment of the nonlinear system analysis through Describing Function and Phase Plane methods.

Steps for conducting various experiments are described along with sample test results.



Experiments:

01. Study of the relay characteristics and display of the same on CRO for different values of hysteresis and dead zones. Hysteresis and dead zone of the built-in 3-position electronic relay are Application software is included for demonstration and also for use as a set of subroutines Study of the effect of inertial and frictional loading on the dynamic performance
02. Study of the effect of hysteresis on system stability. Sustained oscillations may occur in the system under various conditions, especially where hysteresis is present. The amplitude and frequency of such oscillations are predicted from a graphical analysis and then verified experimentally on the unit
03. Phase plane analysis of relay control system for various values of Hysteresis and Dead Zones. The nature of the singular point in the phase plane diagram has importance in the stability studies of nonlinear systems. Here the phase trajectory is viewed on the CRO and the effect of changing hysteresis and dead zone observed

Features and Specifications:

01. Simulated electronic relay using high speed IC's
02. Simulated 2nd order linear plant. Facility for displaying x and x signals
03. Dead zone variable from 0-600mV (approx.)
04. Hysteresis variable from 0-500mV (approx.)
05. Built-in signal sources sine and square Amplitude : 0-1V (min.) Variable
Frequency: 10, 20, 40, 80, 100, 200, 400, 800 and 1000Hz
06. IC regulated internal power supplies

07. 220V±10%, 50Hz mains operation Literature and patch cords included
08. Essential accessory - a dual beam CRO



Relay with deadzone



Linear system

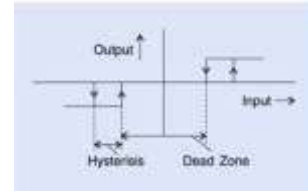

Relay Characteristics

Compensation Design

Order Code - 52040



- * Design and test cascade compensator
- * Simulated system for accurate results
- * Built-in compensator gain only passive external components needed
- * Built-in signal sources

Introduction:

Practical feedback control systems are often required to satisfy design specifications in the transient as well as steady state regions. This is usually not possible by selecting good quality components alone, due to basic physical limitations and characteristics of these components. Cascade compensation is most commonly used for this purpose and the design of compensation networks figures prominently in any course on automatic control systems. Due to the absence of any laboratory experience, however, the concepts of compensation remain rather vague. This unit has been designed to enable the students to go through the complete design procedure and finally verify the performance improvements provided by compensation.

A simulated second order system with variable gain is taken as the 'unsatisfactory system'. Simulated system has the advantage of predictable performance which is necessary if the verification of the results is to be meaningful. Built-in variable frequency square wave and sine wave generators are provided for time domain and frequency domain testing of the system. The frequency may be varied in the range 25Hz - 800Hz and its value read on a built-in frequency meter on the panel. Although most practical control systems have bandwidth upto a few Hz only, a higher bandwidth has been chosen for the simulated system to facilitate viewing on a CRO. A pre-wired amplifier makes the implementation of the compensation network extremely simple. Only a few passive components need plugging into the circuit. Lead and lag networks may be designed and tested on the set-up using both frequency

domain and s-plane procedures. The experimental setup is accompanied by the supporting literature which becomes of vital importance as a major part of the experiment involves theoretical design of compensation networks. Although a complete coverage of design philosophy is not feasible in this document, all efforts have been made to describe the salient features and design steps of the four problems listed above. Also included is a typical design, explicitly covered with compensation network parameter calculation and final results.

Experiments:

- 01. Lag compensation in the frequency domain
- 02. Lead compensation in the frequency domain
- 03. Lag compensation in the s-plane
- 04. Lead compensation in the s-plane

To start with, a suitable 'uncompensated system' is chosen, either by an arbitrary setting of the gain control potentiometer or by setting it to result in a given value of overshoot as seen by step response test. Next a set of specifications - both transient and steady state - are prescribed as an objective by the teacher. The design may then be carried out by one of the above techniques and the results verified by a step response or frequency response testing.

All the above design problems may be undertaken for a very wide range of design specifications. Notice that the implementation of the compensation network has been made very convenient by a prewired amplifier with calibrated gain.

Features and Specifications:

- 01. Simulated 'uncompensated' system having adjustable damping. Peak percent overshoot MP, variable from 20% to 50%, and steady state error variables from 50% to 0.5%
- 02. Compensation network implementation through built-in variable gain amplifier. Gain is adjustable from 1 to 11
- 03. Built-in square and sine wave generators for transient and frequency response studies. Frequency adjustable from 25Hz 800Hz (approx.)
- 04. 220V±10%, 50Hz mains operation
- 05. Complete in all respects, except a measuring CRO

Schematic Diagram

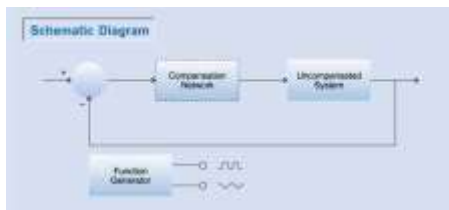

Study Of Second Order Network

Order Code - 52041



Introduction:

Second order networks are important because of the

fact that these are the simplest networks that produce the complete range of transient response from over damping to near oscillations. Although theoretical discussions are normally confined to passive RLC networks, such networks are limited in their performance due to the rather large resistance of any reasonable value inductance that might be constructed to operate at frequencies of few kHz. In the present unit active RC-network has been designed which span the complete behavior of an equivalent passive RLC network. The user thus has the experience of studying a near ideal passive second order network complete with all theoretical computations and their experimental verifications.

Features and Specifications:

- 01. Active second order network
- 02. Damping control over-, critical, and under-damping
- 03. Built-in square wave signal
- 04. Built-in sine wave signal
- 05. Needs an external CRO for response study
- 06. Operates with 220V/50 Hz
- 07. Detailed technical literature and experiment results supplied

Experiments:

- 01. Observe and trace from the CRO screen the step response for different values of z.
- 02. Compute approximate values of equivalent network parameters.
- 03. Plot the frequency response for various values of z and observe resonance.

Study Of Second Order Network

Order Code - 52042



- * Time domain study of a Linear System
- * Op-amp simulated system for greater accuracy
- * Flexible systems configuration
- * Full details of experiments included
- * Additional experiments may be performed

Introduction

The most important performance aspect of a practical system is its response to known input. A large part of the analysis of such systems is therefore devoted to time domain studies. The setup offered is a variable configuration simulated system designed for time domain studies of both open loop and closed loop systems. Selection at block diagram level eliminates the need to bother about the details of electronic circuitry and its assembly. Thus time and efforts could be directed towards understanding and experimenting with the basic aspects of linear control systems. Schematic diagram of the simulator shown includes transfer functions of the form 1/s and 1/(sT+1), a calibrated variable gain K and an error detector. These could be combined to form a variety of system configurations. The unity gain uncommitted amplifier can be used to ensure negative feedback. The time constants have been selected such that the system

response may be observed conveniently on a CRO. This avoids the need to use an expensive and delicate X-Y recorder for the experiment.

Built-in square wave and triangular wave generators provide test inputs to study both transient and steady state responses. Provision is also there to observe the effect of disturbances. Additionally, frequency response studies can be made using an external sine wave generator. An exhaustive literature is supplied with the unit to enable the students to understand and appreciate the intricacies and importance of time response studies of linear systems. It includes steps of mathematical analysis, procedure for experiments, typical results and suggestions for additional experimentation.

Features and Specifications:

01. Simulated first, second and third order system of type-0 and type-1 (4 combinations)
02. Calibrated variable gain amplifier (Resolution 1 : 1000)
03. Built-in signal sources: Square wave and Triangular
Frequency : 45-90Hz
Amplitude: 0-2.5V approximately
04. Trigger output for perfectly steady display on CRO
05. Uncommitted amplifier for phase adjustment
06. Provision for disturbance inputs
07. 220V±10%, 50Hz mains operation
08. Complete in all respect, except a measuring CRO

Experiments:

01. Open loop step response of First Order type-0 system for various values of gain
02. Closed loop step response of First Order type-0 system for various values of gain
03. Open loop step response of Second Order type-0 and type-1 systems
04. Closed loop step response of Second Order type-0 and type-1 systems
05. Steady-State errors for closed loop configuration through triangular wave input

Response of third order system In each of the above, the experimental results obtained by measurements of the response curves can be compared with theoretical calculations.

The number of experiments possible on the unit is not limited to those suggested above. Subject to the availability of time many more variations of the above are feasible

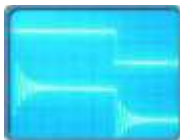

Low damping ratio



Medium damping ratio

Schematic Diagram

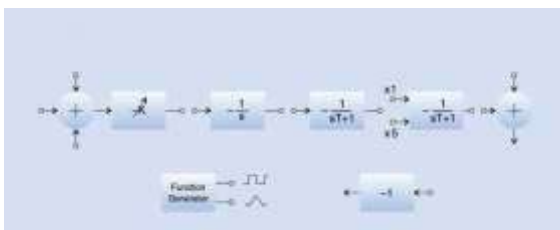

Potentiometric Error Detector

Order Code - 52043



- * High quality servo potentiometers
- * 360° Mechanical, 355° Electrical span
- * DC and AC operation
- * 3½ Digital Panel Meter for all measurements

Introduction

All feedback control systems operate from the error signal which is generated by a comparison of the reference and the output. Error detectors perform the crucial task of comparing the reference and output signals. In a purely electrical system where the reference and output are voltages, the error detector is a simple comparator. In some other systems with non-electrical outputs, the output signal is converted into electrical form through a measurement or transducer block, and then error detection is performed on the electrical signals. A position control system, with both input and output variables as mechanical positions (linear or angular), may however consist of two potentiometers - reference and output, which function as an error detector. Other devices which could be used in similar applications include synchro sets (for a.c. systems), sine-cosine potentiometers, hall effect-potentiometers etc, which unfortunately are not readily available. The present set-up is designed to study the important characteristics of a 2-potentiometer angular position error detector. These include (i) linearity, (ii) sensitivity and (iii) maximum angle of rotation. Good quality wire wound servo potentiometers with full 360° rotation have been used for this purpose. Accurately marked dials with least count of 1° are fixed on the shafts for position indication. The error voltage is read on a built-in 3½ digit DVM. An I.C. regulated internal reference voltage is available for d.c. Studies. When used with an a.c. reference, the unit also demonstrates the phase reversal of the error signal which is important in applications involving a 2-phase servomotor as actuator.

Features and Specifications:

01. High quality servo-potentiometers of 360° shaft rotation
02. Built-in signal and power sources
03. 3½ digit DVM for measurements
04. 220V±10%, 50Hz mains operation
05. Requires an external CRO for a.c. Studies

Experiments:

01. Linearity study of the error detector
02. Determination of error detector gain
03. Use of a.c. supply for the error detector introduction to the phase reversal of error signal



Schematic Diagram



Phase reversal of error

Metric Error Detector

Order Code - 52044



- * Feedback control of light intensity
- * Study of inherent non-linearities sensor, lamps
- * PI control
- * Dynamic response display

Introduction

Feedback is applied in a variety of systems to control different physical variables. In contrast with systems without feedback (open loop systems), the feedback systems (closed loop systems) have lower parameters sensitivity, higher disturbance rejection and greater accuracy. The light intensity control system is designed to bring out these features in the form of a laboratory experiment. The light panel comprises of a number of filament lamps which get power from amplifier. Average intensity of the panel is sensed by a light sensor and a suitable voltage level is produced. Error detector, reference input and error amplifier are of standard configurations found in any linear control system. In addition to the above, the light panel also contains a few uncontrolled lamps which may be used as disturbance source. Further a square wave signal is available for dynamic response studies. Measurement points are provided for monitoring the performance of the system. A detailed user's manual comprising of the system description, experiments to be conducted and typical results is supplied with the set-up.

Experiments:

01. Characterization of light panel and light sensor blocks
02. Study of a practical single loop feedback control system which includes:
 - Disturbance study
 - Error monitoring
03. Performance improvement through P-I control
04. Evaluation of dynamic behaviour
05. Seven lamps 6V/300mA
06. 5Hz square wave and triangular wave for dynamic response study
07. Switch selectable PI-Controller
08. Built-in 3½ digit DVM
09. Built-in IC regulated power supplies
10. 220V±10%, 50Hz Mains operation
11. Detailed literature and patch cords included



Dynamic response of lamps

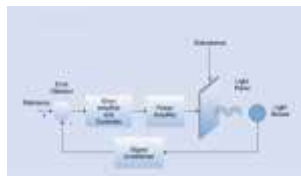

Schematic Diagram

Microprocessor Device Controller

Order Code - 52045



- * Sequence control of 8 LEDs through 8255 port
- * Control of 2 relays
- * Operating a 7-segment display
- * Switch state input through 8255 port
- * SID/SOD Operation

Introduction

This unit has been designed to train the students to handle basic input - output operations of the 8085 microprocessor through 8255 ports. The power supply, drivers and other hardware are pre-wired resulting in a greater reliability of operation. The students are expected to enter a few suggested programs and also to develop their own programs for a variety of input-output operations.

Features and Specifications:

01. System comprises of a main unit and a mp kit
02. The main unit houses all the I/O devices, viz. LED's, relays, 7-segment display, switches and their drivers/interfacing circuits
03. The status of the relays and switches are displayed with the help of lamps mounted on the panel
04. Supporting literature with experiment details

Experiments:

01. Light the 8 LEDs in a cycle, in binary sequence, as a bar graph display etc.
02. Operate the 2 relays with software controlled timing
03. Operate the 7-segment display through segment control
04. Sense the state of the 4-switches as input and send out suitable signals to various output devices
05. Study of SID/SOD commands

Study of Temperature Transducers

Order Code - 52046



- * Temperature controlled oven with digital display
- * Instrumentation amplifier with gain switching
- * Digital voltmeter
- * Interfacing circuits for common transducers

Introduction

Measurement of temperature is an important task in a large number of physical processes. A transducer in a device which converts the temperature information into an electrical signal, usually voltage, for an automated processing. A very wide variety of temperature transducers are commonly available which differ from each other with regards to there:

- a) Range of operation
- b) Sensitivity and linearity
- c) Accuracy, Stability and Repeatability
- d) Speed of response

The present experiments has been designed to study the input-output characteristics of some common transducers like, thermistors (PTC and NTC), thermocouple, semiconductor sensors and may be extended to also study the temperature coefficients of resistances.

The main requirements for an experiment of this nature are,

- a) A precisely controlled from oven with a temperature display which is fast
- b) An adjustable gain instrumentation amplifier which may be used to amplify the different levels of signals from transducers
- c) Interfacing circuits suitable for the transducers used

Features and Specifications:

01. Temperature controlled oven upto 150°C with digital temperature display
02. Built-in interfacing circuit and switched gain instrumentation amplifier
03. Digital voltmeter on the panel for sensor output measurement
04. IC regulated power supplies and detailed manual

Experiments:

01. Temperature-output voltage characteristics of the following transducers in the temperature range of room temperature to 150° C and determination of their parameters
02. Chromel - Alumel thermocouple
03. Copper - Constantan thermocouple
04. Thermistors - Positive Temperature Coefficient
- Negative Temperature Coefficient
05. Semiconductor sensor (type AD590), upto 90°C only

Stroboscope

Order Code - 52047



- * Non-contact speed measurement
- * High intensity flashes
- * Direct speed reading in RPM
- * No shaft modification

Introduction:

Measurement of the speed of a rotating shaft is a common requirement in many industrial and laboratory applications. Such measurements have usually been carried out in the past with the help of contact type tachometers with friction drive. More recently digital optical non-contact tachometers have been designed which count the reflected pulses from a white patch on the shaft and then display the speed in rpm. The light source is usually a filament lamp operating with dry cells leading to limited life and illumination. A similar idea with magnetic pick-up from a particular area of the shaft has also been used for speed measurement. A third category of speed measurement instruments is based on the stroboscope principle. In this a high intensity light flash of a variable frequency is directed towards rotating shaft. Any marking on the shaft appears stationary, if the time of one shaft revolution is a multiple of the flash period. Earlier stroboscopes used neon tubes of low intensity which forced their use close to the rotating shaft. The present unit has been designed to remove most of the above shortcomings. This has resulted in a good quality, convenient-to-use, direct reading speed measuring instrument. A highly

stable function generator IC based circuit provides the basic variable frequency timing pulses. These are read on an IC based 4-digit speed display in rpm. The flasher unit generates the high intensity flashes at a suitably scaled rate directed towards the rotating shaft. A 10 turn potentiometer makes the task of speed setting very precise. Operating instructions are included in the Instruction manual accompanying the unit.

Features and Specifications:

01. Non-Contact-type - no error due to friction drive, suitable for small motors and also motors in inaccessible locations
02. High intensity XENON flashes - operation possible from a reasonable distance (0.5m) in usual ambient light in a room. Detachable lamp unit with 1.5m cable
03. 4-digit speed display in rpm - operating range of 500-9900 rpm, resolution 1 rpm. High accuracy crystal controlled LED display
04. No shaft modification - Any distinctive existing shaft marking may be used. Alternatively use of stickers or markers is possible
05. Power - 220V±10%, 50Hz mains operation.
06. IC regulated internal supplies

Schematic Diagram



Transducer / Instrumentation Trainer

Order Code - 52051



Rugged, self-contained panel trainer with a steel case and integral power supplies. It provides a range of transducer input and output devices together with associated instrumentation circuitry. The transducer and signal conditioning elements of this trainer are typical of those used throughout industry.

These elements include:

- * Transducer input devices.
- * Transducer output devices.
- * Instrumentation circuitry.

Input devices:

For the detection of rotary and linear position, temperature, light, pressure, strain, airflow, humidity and audible and Ultrasonic sound.

Output devices:

For the generation of heat, light, rotary and linear actions, audible and ultrasonic sound and visual indication of voltage, time and number of events.

Instrumentation circuitry:

For the investigation of Wheatstone Bridges and current measurement techniques, linear and non-linear signal amplification, closed and open loop

Control, one, two and three term (PID) control, DC restoration of AC signals, signal transmission techniques and alarm generation.

The comprehensive curriculum manuals provided covers the following topic areas:

- * An introduction to basic control systems.
- * An evaluation of the various Input devices.
- * Practical investigation of the various output devices.
- * Practical investigation of the Display devices.
- * Applications in practical systems, evaluation of input requirements.
- * In depth investigation / analysis of the numerous signal conditioning circuits.
- * Investigation of control system characteristics (On/Off,
- * Proportional, Proportional + Derivative & Proportional + Integral + Derivative)
- * Design and implementation of speed control systems, positional control systems, temperature control systems and light level control systems.

Includes the following items:

01. Instrumentation and Transducer Trainer
02. 4mm Lead set
03. Technical manual
04. Curriculum manuals

Hardware specifications:

Input Transducers:

- * Carbon track, wire-wound and Precision rotary potentiometers.
- * Slide potentiometers.
- * NTC thermistors.
- * Type 'K' thermocouples.
- * I.C. temperature sensor.
- * Photoconductive cell.
- * Photovoltaic cell.
- * Phototransistor.
- * PIN photodiode.
- * Linear variable differential transformer.
- * Linear variable capacitor.
- * Strain gauge.
- * Air flow sensor.
- * Air pressure sensor.
- * Slotted opto sensor.
- * Reflective opto sensor.
- * Inductive proximity sensor.
- * Hall effect sensor.
- * Precision servo potentiometer.
- * Techo-generator.
- * Humidity sensor.
- * Dynamic microphone.
- * Ultrasonic receiver.

Output Transducers:

- * Heater.
- * Filament Lamp.
- * DC motor.
- * Solenoid air valve.
- * Ultrasonic transmitter.
- * Buzzer.
- * Loudspeaker.
- * Relay.
- * Solenoid.
- * Counter/timer unit with LED display.

- * Bargraph voltage indicator.
- * Analog 10V center-zero meter

Signal Conditioning :

- * Buffers.
- * Inverters.
- * Comparator with switchable hysteresis.
- * Amplifiers with gain and offset control.
- * Current amplifier.
- * Summing amplifier.
- * Differential amplifier.
- * Instrumentation amplifiers.
- * AC amplifier.
- * Oscillator 40kHz.
- * Filter 40kHz.
- * Low-pass filter with switchable time constant.
- * Precision full-wave rectifier.
- * Sample and hold circuit.
- * Integrator with switchable time constant.
- * Differentiator with switchable time constant.
- * Converters: V/F, F/V, V/I, I/V.
- * Alarm oscillator with switchable latching.
- * Power amplifier.
- * Electronic switch.

PLC Trainer - Allen Bradley (12 I//O)

Order Code - 52052



Programmable Logic Controller Trainer It provides a complete, structured solution to the problem of training today's industrial control engineers and technicians in the programming and troubleshooting of PLC applications. The following features make the teaching set particularly suitable for industrial training and multi-skilling courses:

- * Industrial-grade controller
- * Industrially relevant applications trainer
- * Sequence switch module for direct control of PLC inputs
- * Remote programming interface package for a PC
- * Quiet source of compressed air
- * Structured self-paced curriculum manual

The teaching set comprises the following products:

- * AB ML1500 - Allen-Bradley MicroLogix 1500 controller, remote programming software and interface cable.
- * Applications trainer
- * Sequence switch module
- * Manually operated compressed air pump
- * Curriculum manual

The AB ML1500 Allen-Bradley MicroLogix 1500 controller provides 12 inputs and 12 outputs, and carries a comprehensive range of on-board facilities, including timers, counters and sequencer functions. The controller is supplied complete with Windows Based remote programming software, which is used to program, monitor, edit and troubleshoot sequences for each of the practical exercises provided in the curriculum manual. An interface cable that connects the computer to the controller for downloading of programs, is also included.

Create sequences which simulate the operation of a modern industrial production line, by sorting parts according to a variety of criteria. Rugged and reliable, the trainer's flexible design allows it to be used in both introductory and advanced PLC applications. Its key features include:

- * A conveyor that can be driven in both forward and reverse directions.
- * A set of cylindrical parts of differing heights and diameters.

The PLC SS Sequence switch module provides a bank Of eight switches which can be used to manually control The inputs of the PLC, in order to simulate a variety of input Conditions.

The PLC EP Electrically operated compressed air pump Provides a safe, very quiet source of compressed air..

The PLC IM Curriculum manual provides a structured, self-paced introduction to the world of programmable logic controllers and their industrial applications. It contains a wide variety of carefully graded programming exercises, Covering the following topic areas:

- * Covering the following topic areas:
- * Introduction to PLCs.
- * Relays and ladder logic.
- * Introduction to ladder logic programming.
- * Input, output and auxiliary relays.
- * Latched relays.
- * Master control reset relays.
- * Timers.
- * Counters and shift registers.
- * Sequencers.
- * Programming the complete system.

An instructor's manual is also included, containing solutions to all programming exercises.

- * A parts bin containing three sections, for sorting parts into different categories.
- * Two sets of parts sensors, each separately adjustable for height and position along the conveyor.
- * Three pneumatically-operated pistons, for pushing parts off the conveyor into the parts bin.
- * Run/stop switches and green/red indicator lamps.
- * Interface electronics to meet the requirements of standard PLC input/output circuits.

PLC Trainer Consists of:

01. AB ML1500 Allen-Bradley MicroLogix 1500 controller, remote programming software and interface cable
02. PLC AM Applications trainer
03. PLC SS Sequence switch module
04. PLC EP Electrically operated compressed air pump
05. PLC IM Curriculum manual

Introduction:

Programmable logic controllers (PLC) have become the standards for control tasks in industry. For technicians and engineers, an understanding of the principles & operations of PLC is very important. The proposed PLC training package offers a complete structured solution to the problems of their training. The trainer uses Industry standard PLC with a realistic application board to achieve its objectives. By providing an industry relevant application the system allows user to gain valuable hands on skills in the use of PLC. The

system teach-ware provides a structured, selfpaced introduction to the world of PLC's and their applications.

Topics Covered:

01. An introduction to relay ladder logic
02. Programming the controller
03. Input, Output and Auxiliary relays
04. Latched relays
05. Master and Zone control relays, Counters and timers, Sequencers
06. Using the remote programming software.

Technical Specifications:

Conveyor System

The conveyor mechanism is fitted with opto-electronic sensors for detection of components and three pneumatic cylinders with solenoid valves for component selection. The system is pre-wired with start/stop switches and red/green indicators. A three-compartmented bin is provided to receive selected components. Interface units are provided for sensors, motors and solenoid valves. A selection of components for exercises is provided.

Sequence Switch Module - PLC SS

This module provides 8 switch selectable outputs derived from the 24V PLC supply. Inputs to the PLC and outputs from the PLC are simulated with this module. Supply Voltage 110V or 240VAC 50/60Hz.

The system is provided with all suitable hoses and connectors, also user manual, student experiments manual and lecturer's guide. The trainer comprises of the following:

- * 1 x Conveyor Belt – DC Motor driven
- * 2 x Optoelectronic Sensors
- * 3 x Sping return single action pneumatic pistons.
- * 3 x Pnuematic solinoid valves
- * 3 x Reed relay position switches

On board power supply and interface.

The system is designed to be used with an industrial standard PLC unit or an IBM/PC Simulator System.

Industrial Controller

The controller unit should be of a type usually used in industrial applications. It should consist of a processor unit and hand-held programmer. The processor unit should have multiple inputs and outputs (for eg. 10 inputs and 10 output).

The industrial Controller shall have the following specification.

Inputs	: 10-30VDC optically isolated with LED status indicators.
Outputs	: Relay contact rated 10-250VAC or 10-125V DC.
Memory	: 1200 words with back up. Timers, counters, sequencers, and shift registers: 32
Timers	: 0.1 to 999.9s
Counters	: 0.1- 9999
Sequencers	: 8 bit groups, 100 steps
Shift registers	: 8 zone, cascadable.
Internal relays	: 150
Supply voltage	: 85-132V DC or 170-265VAC 50/60Hz.

Electrically operated compressor - PLC EP

This provides a safe source of compressed air, volume 5 litres at a pressure of 3 bar. The air supply is sufficient

For at least 200 cylinder strokes(16mm dia) or 500 cylinder strokes (10mm dia).

Sequence switch module - PLC SS

Based on a pcb mounted on a pvc base, this module provides a switch-selectable output code facility. It is used with a PLC application device for experimentation purposes. It features 8 output lines each of which can be selected as on or off using slide switches, output termination must be via standard screw-clamp terminals.

PC Based Analog & Digital Motor Control Trainer

Order Code - 52053



This Comprehensive training system contains the following modules :

- * DCMC DC Motor Control Module
- * COMPOT Command potentiometer.
- * SCLS Simulated Control Laboratory Software.
- * Cable Set 4 mm Lead set.
- * SPSU System Power Supply Unit.
- * Analog control -an overview
- * Describing and identifying system behavior.
- * Time and frequency response.
- * Principles of feedback.
- * Proportional position control.
- * Behavior of second order systems.
- * Position control with velocity feedback.
- * 3-Term or PID control / Stability.
- * The use of computers for control.
- * Analog and digital interfacing .
- * Direct digital control.

DCMC DC motor control module...

Features of the DCMC DC motor control module include:

- * DC motor with on-board drive circuitry.
- * Angular position indication disc. Calibrated in degrees.
- * Tach-generator with switchable load resistor.
- * Continuous rotation potentiometer.
- * Gray-coded disc and slotted disc.
- * Digital tachometer with r.p.m. Readout.
- * Three-position eddy current brake.

COMPOT Command potentiometer module...

The COMPOT Command potentiometer is used to provide a manually generated command signal to the control system. The calibrated indicator disc provides an angular position indication in degrees.

SCLS Simulated Control Laboratory Software

The simulated control laboratory is a comprehensive teaching package that has been designed specifically for use with the following motor control products :

- * DCMC DC motor control module.
- * COMPOT Command potentiometer.

When used in conjunction with a windows TM based PC. the SCLS Simulated Control Laboratory Software performs the following functions simultaneously.

- * Monitors the reference signal from the Command

potentiometer.

- * Provides a proportional-integral - derivative (PID) controller with adjustable parameters.
- * Generates analog / digital signals to control the DC motor module.
- * Responds to analog/digital feedback signals from the DC motor module.
- * Displays all control and feedback signals on the PC screen.

A competence-based curriculum manual covering both analog and digital control is provided with the SCLS simulated control Laboratory Software.

The Simulated control laboratory comprises the following items:

- * Real time Windows™ based Simulated Control Laboratory Software (SCLS)
- * PC Interface Module (PCIM) and PC connection cable.
- * Analog/Digital Motor control curriculum manual.

The main screen of the SCL Software can be divided into four sections, each of which may be configured independently by the user:

- * Control reference (input) signal
- * Controller
- * Plant
- * Display

Control reference (input) Signal : The input can be set from the internal SCLS signal generator or from the external plant Signal generated by the COMPOT Command potentiometer. SCLS can provide sine, step, ramp, sawtooth, random, DC level and pulse waveforms. The sampling rate or frequency can be set.

Controller : The controller can be set to :

- * Open Loop - Reference Signal output directly to allow open loop identification testing.
- * Proportional-Provides control of proportional gain.
- * Servo-Provides control of gain and velocity feedback.
- * PID-Provides control of proportional band. integral time constant and derivative time constant.

Plant : External Analog- Outputs the drive signal via the PC analog interface and measures the voltages representing the motor position and velocity.

- * External Digital - Outputs the drive signal via the PC PWM interface and measures position and speed using gray code and slotted discs.
- * Servo - Simulates a servo system by providing output and velocity signals. Used with the servo controller for simulations.
- * Process - Simulates a 2nd order plant without an integrator. Transport delay can be added. Used with the proportional and PID controllers.

The appropriate external plant should be selected when using the DCMC DC motor control module. The servo and process plant simulations can be used to illustrate behavior not displayed by the real plant and can illustrate the differences between theory and practice. **Display :** The eight-channel real-time display can show all the control signals involved in oscilloscope, bar graph, panel meter and list forms. The channels are

color coded according to their positions within the control loop. For clarity, traces can be switched OFF when not required.

The display can be frozen and the values transferred to disk for printing or further analysis. As well as text format, the disk file can be in Excel or Matlab format.

PC interface module

* The PC interface module has been designed to connect directly to the parallel port of a PC via the cable supplied.

* The Sockets on the PC Interface module allow direct module connection to the inputs and outputs of the DCMC DC motor module and COMPOT Command potentiometer, via 4 mm leads.

* The PC interface module may be powered from the same power supply as the DCMC DC motor module.

* An instructor's manual and student workbook are also Provided.

DC Position Servo Trainer (Analog & Digital)

Order Code - 52054



Order Code 52054 DC Position Servo Trainer (Analog & Digital) is designed specifically for the study of DC Servo Trainer and its use in Angular Position control. This Trainer covers the fundamental facts of DC Servo Trainer and its characteristics this trainer makes the student familiar with the DC Angular position control & DC Servo System. Four experiments can be performed by the trainer.

Practical experience on this board carries great educative value for Science and Engineering Students.

Features:

The Trainer Consists of following built in parts

01. Servo Mechanism Provided
02. DC Geared Servo Motor
03. Two DPM Provided for Angular Position Display in degree
04. Master & Slave Dial special 360° rotation
05. Master Dial Pot
06. ± 12V DC at 100mA, IC Regulated Power Supply
07. ± 9V DC at 250mA, IC Regulated Power Supply
08. A Control Circuitry
09. Mains ON/OFF Switch, Fuse and Neon Indicator are provided
10. Adequate no. of patch cords 4mm length 50cm.
11. Good Quality, reliable terminal/sockets are provided at appropriate places on panel for connections /observation of waveforms.
12. Strongly supported by detailed Operating Instructions, giving details of Object, Theory, Design procedures, Report Suggestions and Book References.

List of Experiments:

Following Experiments can be performed:

01. To Study DC Motor Angular Position Servo System
02. Measurement of Dead Zone
03. To Study the different Characteristics of Servo

System

- Hunting
- Repeatability
- Noise Free

04. Other Characteristics of Servo System

- Fast Response
- High Accuracy
- High Sensitivity
- Linearity
- Resolution

Other Apparatus Required:

01. Cathode Ray Oscilloscope 20MHZ

DC Servo Motor Trainer

Order Code - 52054A



DC Servomotor is commonly used as an actuator in many industrial control applications because of its features - large torque and ease of speed variation. The dynamic characteristics of such a system therefore depends on the motor parameters viz., moment of inertia, coefficient of friction, time constant and also the resistance and inductance of the control winding. It is therefore important to experimentally determine the mechanical and electrical parameters of the DC Servomotor and also to evaluate its transfer Function.

The present unit is designed to study a permanent magnet DC Servomotor. This motor is coupled with a load using 2Kgs Spring balance which is transparent & provided for mechanical loading. The shaft speed in rpm is displayed automatically on a 4-digit panel meter. An important feature of the unit is the built-in absolute speed measurement through optical pickup from a slotted disk followed by a frequency counter. The 4-digit speed display is therefore completely independent of the tachogenerator characteristics. The high accuracy of speed reading is due to a built-in crystal oscillator. Another interesting design feature is the use of an 'electronic tachogenerator' - a frequency to voltage converter, for the generation of speed feedback signal. This highly linear, non-contact transducer is ideally suited for the small DC motor being used in the unit.

The motor unit is housed in a cabinet with transparent panels, providing a good view of the mechanical system

Features:

01. Speed control of a 30V/2A, permanent magnet d.c. motor.
02. Speed range: 0 to 2000 rpm (typical).
03. Opto-interrupter based speed sensing.
04. 4-digit speed display in rpm.
05. Electronic tachogenerator for feedback.
06. Separate unit for motor in a see-through Cabinet.
07. 2Kg Spring Balance provided for loading.
08. Built-in 3 ½ digit DVM for signal measurements.
09. Built-in 3 ½ digit Current Meter.

Interconnections

All interconnections are made using 2mm banana Patch cords.

* Test points are provided to analyze signals at various points.

- * All ICS are mounted on IC Sockets.
- * Bare board Tested Glass Epoxy SMOBC PCB is used.
- * In-Built Power Supply with Power ON indication
- * Attractive ABS Plastic enclosures.
- * Set of 2mm Patch cords for interconnections
- * User's Manual.

List of Experiments:

01. Effect of loading on the speed of motor in the open loop.
02. Determination of the motor transfer function and tachometer characteristics.

Motion, Sound & Force Trainer

Order Code - 52057



The Instrumentation trainer introduce student to input sensors, output sensors, signal conditioning circuits and display devices through a wide range of hands-on practical activities. This self contained trainer has all the necessary power supplies, light sources and a wide range of hands on experiment work.

The trainer is supplied with a detailed curriculum manual that provides background theory, practical activities and student assessment questions.

A student workbook is also provided allowing students to create a personalized record of their work together with practical results as they work through the curriculum materials. Finally, an instructor's guide is provided offering solutions to all of the questions and practical activities contained in the curriculum manual and student workbook.

The bench-mounted trainer features the following devices and circuits.

Input Transducers:

- * Linear variable differential transformer
- * Linear variable capacitor
- * Strain guage
- * Humidity Sensor
- * Dynamic microphone
- * Ultrasonic receiver

Signal Conditioning:

- * Signal conditioning amplifiers
- * Comparator, Oscillator and filters
- * Wheatstone Bridge

Typical Topic Areas Include:

- * Positional resistance transducer
- * Wheatstone bridge measurement
- * Linear position or force Application
- * Environmental measurement
- * Sound measurement
- * Sound output
- * Linear motion
- * Display Devices

Output Devices:

- * Buzzer
- * Relay
- * Solenoid

- * Loudspeaker
- * Ultrasonic Transmitter
- * Bargraph voltage indicator
- * Analog 10V Center-zero meter

Positional Resistance Transducers:

- * Carbon Potentiometer
- * Wire wound potentiometer
- * Slide potentiometer
- * Wheatstone Bridge

Item Supplied With The Instrumentation Study Module Include:

- * Instrumentation Technical Manual
- * Curriculum manual
- * Instructor's Guide and student workbook

External Power Supplies:

- * -5V, +5V 1A precision supply
- * -12V, +12V 1A regulated supply On board power supply Terminals

Rotational & Air Sensors Trainer

Order Code - 52058



The Positional Sensor study modules introduce students to input and output transducer, signal conditioning circuits and display devices through a wide range of practical activities. The study module includes a transducer and instrumentation trainer and a curriculum manual.

The curriculum manual is divided into a series of chapters. Each covers a specific topic area and provides background theory, practical activities and student assessment question.

A student workbook is also provided, allowing student to record basic theory and practical results as they work through the curriculum manual. Finally, the study module includes an instructor's guide. This provides solutions to all of the questions and practical activities contained in the curriculum

Signal Conditioning:

- * Signal conditioning amplifiers
- * Comparators oscillators and filters
- * Mathematical operations

Output Devices:

- * DC Motor
- * Solenoid Air Valve
- * Counter/timer unit with LED display
- * Analog 10V center-zero meter

Typical Topic Areas Include:

- * Positional Resistance Transducers
- * Wheatstone Bridge Measurements
- * Rotational speed or position Measurement
- * Linear or Rotational Motion
- * Display Devices
- * Control Systems Characteristics
- * Practical Control Systems.

External Power Supplies:

- * -5V, +5V 1A precision supply
- * -12V, +12V 1A regulated supply On board power supply terminals

Input Transducers:

- * Air-flow sensor
- * Air pressure sensor
- * Slotted opto-sensor
- * Reflective opto-sensor
- * Inductive Proximity sensor
- * Hall Effect sensor
- * Precision servo-potentiometer
- * Tachogenerator

Positional Resistance Transducers:

- * Carbon Potentiometer
- * Wire Wound Potentiometer
- * Slide Potentiometer
- * Wheatstone Bridge

Item Supplied With The Instrumentation Study Module Include:

- * Instrumentation Technical Manual
- * Curriculum manual
- * Instructor's Guide and student workbook

Typical Activities Include:

- * Compare the application of a carbon track variable resistor with those of a wire-wound type.
- * Select a suitable display device for a particular voltage measurement.
- * Investigate the construction and characteristics of an air flow transducer.
- * Determine the characteristics of an ON/OFF control system.
- * Investigate the characteristic of a speed control system.

Sensors Trainer

Order Code - 52059



The Signal Conditioning Circuits trainer introduces students to display devices through a wide range of hands-on practical activities. This self contained trainer has all the necessary power supplies.

The trainer is supplied with a detailed curriculum manual that provides background theory, practical activities and student assessment questions.

A student workbook is also provided, allowing students to create a personalized record of their work together with practical results as they work through the curriculum materials. Finally, an instructor's guide is provided offering solutions to all Of the questions and practical activities contained in the curriculum manual and student workbook.

The Bench-mounted Trainer Features The Following Circuits

- * Buffer
- * Inverters
- * Comparator with switchable hysteresis
- * Amplifiers with gain and offset control
- * Current amplifier

- * Summing amplifier
- * Differential amplifier
- * Instrumentation amplifier
- * AC amplifier
- * Oscillator 40kHz
- * Filter 40 kHz
- * Low pass filter with switchable time constant
- * Precision full-wave rectifier
- * Sample and hold circuit
- * Integrator with switchable time constant
- * Differentiator with switchable time constant
- * V/F and F/V Converters
- * V/I and I/V converters
- * Alarm osc with switchable latching
- * Power amplifier
- * Electronics Switch

Typical Topic Areas Include:

- * Positional resistance transducers
- * Wheatstone bridge measurements
- * Display Devices
- * Control system characteristics

External Power Supplies:

- * -5V, +5V 1A precision supply
- * -12V, +12V 1A regulated supply on board power supply terminals

Positional Resistance Transducers:

- * Carbon Potentiometer
- * Wire Wound Potentiometer
- * Slide Potentiometer
- * Wheatstone Potentiometer

Item Supplied With The Scc Study Module Include:

- * SCC Technical manual
- * SCC Curriculum manual
- * Instructor's guide and student work-book

Motor Control Trainer

Order Code - 52060



Order Code- 52060 is one of the most comprehensive motor control trainers. This system is designed for learning the working Principal of different types of motors. Students will learn not only the foundation of motors but also controlling the motors with Descriptive Components, Microcontroller 8051 and Computer Interface via Rs232. Experiments are specially designed for this system right from the basic stepper motor forward/ reverse, speed controls to all Actuators control. HALF, FULL and WAVE modes

On Board Technical Specification:

Actuators:

- * Unipolar Stepper Motor
- * Bipolar Stepper Motor
- * Servo Motor
- * DC Motor

Displays:

- * 16x2 LCD Display (Mode indication, Direction and Step Rate Measurement)
- * 3mm RED LEDs for (Motor phase Indication, Direction and Modes).

Switches:

- * Matrix Keypad : For Selecting Mode : Microcontroller Mode or RS232 mode and also for selecting Direction and Input Stepping).
- * SPDT Switch: This for Stand Alone Mode without Microcontroller. Mode selection (HALF, FULL and WAVE), Speed Controlling, STEP Mode and RUN Mode Selection.

Microcontroller Based:

Onboard AT89C51RC microcontroller with 32K bytes of Flash programmable ROM & 512 bytes of RAM.

Serial Communication:

- * PC Interface-RS 232 communication port.

Programmable Logic Controller Demonstrator (PLC- Allen Bradley)

Order Code - 52061



Features:

- * 52061 is a versatile & most comprehensive demonstrator setup to perform unique and hand-on training experiments related to PLC.
- * The Pico family of Nano PLCs from Allen Bradley, are smallest & most Economical Controller.
- * They offer Performing Simple Logic, Timing, Counting & Real Time Clock Operations.
- * DT-4001, is built around Allen Bradley's PICOLOGIX.
- * Built in power supply (24V DC).
- * Input voltage Category (24V DC).
- * Memory Size : 512 Instructions
- * 6 Digital Inputs for Input Interface (Max 24 VDC).
- * 4 Relay outputs for output Interface.
- * 2 Analog Output (0....10V DC).
- * Contacts DC.
- * PWM Output.
- * High Speed Counter.
- * 16 internal bits for intermediate data storage.
- * 8 real-time clock instructions.
- * 16 analog compare instructions.
- * 16 text display screens.
- * Voltage Output Block Input / Output Section.
- * SPDT Switches are used to simulate the PLC Input.
- * 4 Soft Input controlled by the on-Board Keypad.
- * High Quality 10mm LED's are used to simulate the PLC output.
- * Highly accurate Circuits are used to generate this for Instrumentation purposes, usually using a quartz crystal oscillator within a sealed temperature controlled chamber known as a crystal oven or OCXO (Oven Controlled Crystal Oscillator).
- * I/O interfaces allow the user to send information to

the Frequency Counter and receive information from the Frequency Counter.

- * Commonly-used interfaces include Rs232, USB, GPIB and Ethernet.
- * Supplied in attractive Wooden / Metallic enclosure.
- * Documentation includes User Manual with details.
- * Cable & connector set available for interfacing.
- * Suitable software & PC Interface options are also available.

CNC Engraving Milling Trainer

Order Code - 52062



Performance Expectations And Cutting Ability:

- * Spindle Speed Range : 6000-24000RPM
- * Spindle Power: 1.5KW (2HP) Air cooled (VFD Control)
- * Feed Rate Range: 600mm/min for X, Y & Z axis.
- * Suitable for engraving on Steel, Soft metals and plastic.
- * Suitable for Milling on all soft metals and plastics / acrylic.
- * 0.08kW coolant pump and tank.

Resolution, Accuracy And Repeatability:

- * Feed Motors- Steppers (open loop)
- * Resolution of Motion (minimum 0.002 mm discrete positional move)
- * Ball Screw Positional Accuracy £ 0.01mm per foot
- * Combined Positional Accuracy2 £ 0.05mm per foot

Components

- 01 Electrical
- 02 MAIN MCBS
- 03 17" LCD
- 04 Keyboard & Mouse Table
- 05 Red-e Stop
- 06 ON/OFF- Switches
- 07 Spindle & Vfd Control
- 08 Hand Lubrication Pump
- 09 Coolant Collection Trays
- 10 Base Table
- 11 CPU Access Door
- 12 Coolant Pump With Tank

it is intended for use as a general purpose CNC Engraving and light duty milling machine. The intended use includes Engraving on steel, soft metals and cutting conventional (non-abrasive) materials such as Non ferrous metals, aluminum, plastics, wood and similar materials (or any other material that can be cut with a rotating cutter.

Actuators:

- * Unipolar Stepper Motor switches, LED lamps, VFD drive controller and E-stop switch:

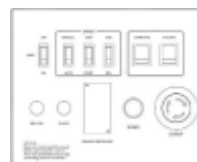

Includes additional contributing factors such as compressibility of bearings, ball screw windup, friction etc.

Each is delivered with a Certificate of Inspection. This report details each of the quality assurance measurements performed at the factory by a quality assurance team member prior to approving delivery of each machine.

Key Dimensions (Machine Bed)

Length	: 250mm
Width	: 370mm
T-Slot width	: 10mm
T Slot C-C	: 110mm
No. of T-Slots	: 4 slot along Y-axis
Max Weight on Table	: 60kg
Spindle nose to bed (max.)	: 240mm
Spindle nose to bed (min.)	: 20mm

Travel

X-Axis	: 310mm
Y-Axis	: 210mm
Z-Axis	: 230mm

Spindle

Speed Range	: 6000-24000 RPM
Max. Rating	: 2HP (1.5KW)
Collet	: ER16M (0.5mm-8mm cutter)

Feed Rates

Rapids on X-Axis	: 800mm/min
Rapids on Y-Axis	: 800mm/min
Rapids on Z-Axis	: 800mm/min
Max. Cutting	: 600mm/min (X, Y)

PID Controlled Oven

Order Code - 52063



Small ovens are frequently used in class room experiments for the determination of temperature coefficients of resistances, capacitances, zener diodes, and also for studying the leakage currents of semiconductor devices at various temperatures. Conventional arrangement with oven fed from an auto transformer and thermometer type temperature measurement is unsatisfactory due to the long time it takes the oven to heat or cool, large time constant of mercury thermometers and difficulty in setting and maintaining a particular temperature.

Description

This is high quality PID controlled oven suitable for testing of electronic components & study of temperature transducers etc. The oven has been designed for fast heating and cooling rates which enhances the effectiveness of the controller. SSR driven heater and accurate temperature control. A platinum RTD has been used for sensing the temperature.

Safety Instruction Warning

01. An external protection device must be installed if failure of this instrument could result in damage to the instrument, equipment or injury to personnel.
02. All wiring must be completed before power is turned on to prevent electric shock, fire or damage to instrument and equipment.
03. This instrument must be used in accordance with the specifications to prevent fire or damage to instrument and equipment.
04. This instrument is not intended for use in locations subject to flammable or explosive gases.
05. Do not touch high-voltage connections such as power supply terminals, etc. to avoid electric shock.

Technical Specification:

Temperature

Range	: Ambient to 200 C
Resolution	: 0.1 C
Stability	: Less than + 0.2 C Measurement
Accuracy	: + 1 digit
Oven	: Top Open Heating Chamber. Oven heating up to 200 Chamber L80 x W80 x H105mm
Sensor	: RTD (A Class)
Display	: Process value 4 digit 7-segment Red LED
Power	: Set Value 4 digit 7-segment Green LED.
Power Consumption	: 120 Watt

Caution

01. This instrument is protected from electric shock by reinforced insulation. Provide reinforced insulation between the wire for the input signal and the wires for instrument power supply, source of power and loads.
02. This instrument is designed for installation in an enclosed instrumentation panel. All high-voltage connections such as power supply terminals must be enclosed in the instrumentation on panel to avoid electric shock by operating personnel.
03. All precautions described in this manual should be taken to avoid damage to the instrument or equipment.
04. All wiring must be in accordance with local codes and regulations.
05. Always observe precautions described in this manual. Otherwise serious injury or accident may result. Do not allow metal fragments or lead wire scraps to fall inside this instrument. This may cause electric shock, fire or malfunction.
06. Firmly tighten each terminal screw at the specified torque. Otherwise electric shock or fire may result.
07. Do not place any obstacle around this instrument in order not to impede radiation of heat. And do not close ventilation holes.
08. Do not connect wires to unused terminals.
09. Before cleaning the instrument, always turn off the power supply.
10. Remove stains from this instrument using a soft, dry cloth. Do not use a volatile solvent such as thinner in order to avoid deformation or discoloration.
11. Do not rub nor strike the display unit of this instrument with a hard object.

List Of Accessories

01. One with 1meter cord along with 5pin socket 01
02. 3Core Electrical wire along with 4mm Banana Pin, Red, Black, Green, with Teflon block having diameter ID 10mm for finding out temperature coefficient of resistance, capacitances, zener diodes etc.

Selec PLC Trainer

Order Code - 52065



Specifications:

- * 13 digital input and 8 digital outputs

Supply Voltage

- * 85-270VAC

Display

- * LCD (backlight) 4line x 16 Characters font size 5X7mm

Digital Input

- * 13 Digital Input, PNP type

Digital Output Relay

- * Digital Output (Relay Type)

Programing Method

- * Windows beads Software for ladder programming and HMI configuration

Memory

- * Data Memory : 16Kbytes
- * Code Memory : 351kbytes
- * Upload Memory : 96kbytes

Communication Ports

- * Rs485

Communication Protocol

- * MODBUSRTU

RTC

- * Yes (with 2years battery life From the date of manufacture)

Onboard user interface

- * 7 segment LED display
- * Stepper motor
- * 16SPDT slider switches
- * 13DPDT slider switches
- * 29 Tact switches
- * 174 LEDs available onboard

Experiments:

01. Day light tower
02. Traffic light control
03. Four-phase stepper motor control (physical control)
04. Automatic liquid mixing device
05. Assembly line control
06. Water level control tower
07. Manipulator control
08. LED digital control
09. Four conveyor control
10. Vending machine control
11. Three floor elevator control
12. Mail sorting control
13. Rolling mail control
14. Automatic plating
15. Logic gate (AND, OR, NOT,NOR NAND, EX-OR, EXNOR)

Light And Temperature Trainer

Order Code - 52066



Temperature Sensors:

- * LM335
- * Platinum RTD Resistance
- * N.T.C. Thermistor
- * Thermocouple

Having Studied This Module (temperature Sensors) :

- * Describe the characteristics of an IC temperature sensor
- * Describe the construction and characteristics of a platinum RTD resistance
- * Describe the construction and characteristics of an n.t.c. Thermistor
- * Discuss the characteristics of n.t.c. thermistor bridge circuits.
- * Describe the construction and characteristics of a thermocouple
- * Reduce temperature from a voltage reading across a transducer

Light Measurement:

- * Filament Lamp
- * Photovoltaic Cell
- * Phototransistor
- * Photoconductive Cell
- * PIN Diode

Having Studied This Module (temperature Sensors) :

- * Discuss the characteristics of a filament lamp
- * Describe the construction and characteristics of a Photovoltaic Cell
- * Describe the construction and characteristics of a Photo transistor
- * Describe the construction and characteristics of a Photo conductive Cell
- * Describe the construction and characteristics of a PIN photodiode

On Board Power Supplies:

- * -5V, +5V 1A precision supply
- * -12V, +12V 1A regulated supply

Hydraulic/Electro Hydraulic Trainer

Order Code - 52067-56068



Salient Feat

01. Choice of 2 top models Hydraulic, Electro Hydraulic trainer (Optionally PLC may be supplied.)
02. Use of aluminium profile grooved plate (CD=25mm) experiment board. Optionally table with drawers (3 nos.) To store components when

- not in use & 4 Nos. of caster wheels.
- 03. Quick release socket plug arrangement for building circuits, Lighter pneumatic components are mounted using lever operated mounted adapters for quick release & placement.
- 04. List of components may be modified as per your requirement.
- 05. Top electrical panel row exists in electro hydraulic / Pneumatic only.

Technical Specification:

Order Code - 52067 - Hydraulic Trainer

Items Oil Distribution and manual controls gages

- * Sub plate (1 Station manifold) with 4 ports & 2 gauge ports.
- * Quick Release male Adaptors
- * Modular pressure relief valve (sub plate mounted) with 70 bar
- * Glycerine filled pressure gauges to A & B ports (2X2)
- * Throttle cum check valve sub plate mounted

Direction control Element

- * 4/2 way DC valve lever operated spring return
- * 4/2 way DC valve AC 230Vac solenoid operated spring return
- * 4/3 way DC valve lever operated spring return
- * 4/3 way DC valve lever operated detented
- * Single acting cylinder 40mm X 100mm stroke with QR adaptor

Actuating devices (output)

- * Double acting cylinder with in line flow control valve 40mm X 100mm stroke & QR sockets

Connections

- * Flexible hoses, R1 type ¼ ID with Quick release (One end 90° & other straight)
Length 2000mm
Length 1500mm
- * Quick release plugs(M)
- * Quick release plugs(M)

Electrical Connection

- * Mains cord for 230 Vac solenoid with stakable connector

Order Code - 52068 - Electro Hydraulic Trainer

Items Oil Distribution and manual controls gages

- * Sub plate (1 station manifold) with 4 ports &
- * Gauge ports each equipped with
- * Quick Release Male Adaptors
- * 70 bar Glycerine filled pressure gauges to a and b ports

Direction control Element

- * 4/2 way single solenoid 24 VDC spring return
- * 4/3 way double solenoid 24 VDC spring return
- * Single acting cylinder 40mm X 100mm spring return & QR adaptor

Actuating devices (output)

- * Double acting cylinder with in flow control valve 40mm X 100mm stroke & QR sockets

Connections

- * Flexible hoses, R1 type ¼ ID with Quick release (One end 90° & other straight)
Length 2000mm
Length 1500mm
- * Quick release plugs(M)
- * Quick release plugs(M)

Electrical Connection

- * Electrical circuit 4mm Banana Patch cord 1mtr

500mm

100mm

Logic Control

- * Limit switches NC/NO
- * Proximity Switch (Inductive)

Resource Panel

- * 24VDC power supply. 8 Relay card PLC interfaceable with NO NC contact & 24Vdc coil, Dual Timer WITH NO - NC contacts or Optionally LG PLC (12 input + 8 output) with CDP & ladder software.

General Specification:

Power Generation

- * Power pack (50 bar) consist of : a) Tank 25Ltr. b) Gear pump 3LPM with ball valve for flow measurement in Beacker (optional), c) Electric motor 0.5 HP 1440 RPM 230vac, d) Oil Breather Oil level indicator, suction filter / Strainer Return line filter, 70 bar Gage , e) Relief valve.

Mechanica Dimension

- * Anodised sturdy Aluminum profile rack (table top) with groove experiment board (Optibally double sided). Total dimension : 1165mm (W) X 800mm (H), Aluminum grooved T bolt Board : L = 107 cm, W = 70cm. Height 700mm Reclining at 00, 200,300, . Oil Tray (107 cm A 300 cm X 2cm) power coated MS NET Weight : 70/75 kg. (Electrohyd), Gross Weight : 85/90kg. (Electrohyd).

Optional Experiments only for Electro hydraulic Trainer

- * Servo position control (Close loop) consisting of CIP panel with servo control using relay control circuit, EMT8 powersupply for stroke length display, liner motion (100mm, stroke) potentiometer (5KW) as a position sensor coupled to D. A. For cylinder.
- * Proportional flow and direction control valve with built in amplifier with ±5V I/P voltage to control flow and direction 5KW Trainer servo pot to sense Position coupled to D.A. cylinder, open loop position contron, panel to display stroke length.
- * Proportional flow and direction control valve with amplifier card & LVDT feedback close

Electro Hydraulic Trainer

Order Code - 52068A

Order Code - 52068A is a sophisticated, indigenous, new generation hydraulic teaching aid, specially developed to impart the best practical training in hydraulics. It can be used as a Live Demonstrator to show functioning of various hydraulic components and control circuits. Operating pressure is kept at 20 bar for safety of the students. The components / equipments are mounted on an ergonomically designed mobile metal trolley with drip tray. The power pack is mounted at the bottom. The components are permanently mounted on the working area. "Quick Release Couplings" are used on the components and hoses for fast and easy connections. All the components are duly fitted with "Quick Adapters" and the hoses are fitted with quick couplers. The Basic Hydraulic Trainer consists of ·



Specifications:

Hydraulic Power - Pack :

- * 230V/50Hz AC Motor
- * 1425 rpm 1hp AC Induction Motor
- * 3 LPM Gear Hydraulic pump
- * 100bar Pressure Gauge
- * Direct Operated Pressure Relief Valve up to 100bar with Pressure Gauge
- * Check Valve
- * Suction Filter
- * In Line Filter
- * Oil Level Indicator
- * Oil inlet Lid

Hydraulic Trainer consist of 16 slot 15x80mm Aluminum panel to accommodate all types of Hydraulic components mounted on 40x40mm Aluminum profile rack.

DC Power Supply & Switch Panel

- * 230V/50Hz AC Socket
- * 24V/2A DC Output
- * 5 no's of Toggle Switch /2A

Dual Timer Panel

- * Dual Cyclic Timer Output
- * 4 no's of NO,NC control contacts /2A

Switch Panel

- * Two nos. of SPDT Switch Red, 230V/4A
- * Two nos. of SPDT Switch Green, 230V/4A
- * SPDT Emergency Switch, 230V/4A
- * Illuminated Push Switch, 230V/4A

Relay & Indicator Panel

- * 3 numbers of Relay Output
- * 5A NO,NC control contacts with coil voltage 24V/100mA
- * 230V / 22mm Led Indicators (3nos)

List Of Components

- * Double Solenoid Valve (4/3 way) 24V coil up to 350bar/60LPM
- * Double Solenoid Valve (4/2 way) 24V coil up to 350bar/60LPM
- * Direct Operated Pressure Relief Valve up to 100bar
- * Single Acting Cylinder (10cm stroke) up to 100bar
- * Double Acting Cylinder (10cm stroke) up to 100bar
- * Pressure Switch 24V up to 100bar
- * Check Valve up to 100bar
- * Needle Control Valve
- * Flow Control Valve
- * Proximity Sensor 8mm dia, PNP type 10-24V
- * Electrical Limit Switch (No: NC: C)
- * 100bar Pressure Gauge (2 nos)
- * 4 port Manifold (2nos)
- * QRC fitted Hose Pipe (6 nos.)
- * Diaphragm Accumulator
- * Measuring Flask (2 liters)
- * Loading Weight 15Kgs

Optional Hydraulic Components

- * Pressure Reducing Valve
- * Shut off Valve
- * Sequence Valve
- * Hydraulic Motor
- * Rotameter to measure upto 4 LPM
- * Pilot Operated Pressure Relief Valve
- * Pilot Operated Check Valve
- * Counter Balance valve
- * Pressure Compensated Flow Control valve

Optional Plc

- * 8 channel 24V DC Digital Input
- * 6 Channel Relay AC/DC(2A) output.
- * 8 Digital Input Switches for Simulation with Led Indicator
- * 6 Output Led's for Output Simulation.
- * Built in RS-232 Communication Port
- * Built in Power supply of 24V dc Input
- * All Inputs & Outputs are terminated in 2mm Banana connector

Note: Hydraulic Oil is to provided from customer end.

Hydraulic Work Bench (optional)

MS square tube (Heavy duty) Color powder coating with rubber wood/MS table top and one pedestal drawer unit having 3 drawers, each with handles and individual locks, on metallic full panel drawer slide:

- * Work Table Size (Approx.) L1100mm X W750mm Xh760mm, with four castor wheels including two lockable wheels at the front side
- * Drawer Size (Approx.)
 - Upper & Middle Drawer L500mm x W500mm x H150mm (Each)
 - Lower Drawer : L500mm x W500mm x H200mm (Approx.)

Hydraulic Trainer System

Order Code - 52068B

Order Code - 52068B is a sophisticated, indigenous, new generation hydraulic teaching aid, specially developed to impart the best practical training in hydraulics. It can be used as a Live Demonstrator to show functioning of various hydraulic components and control circuits. Operating pressure is kept at 20 bar for safety of the students. The components / equipments are mounted on an ergonomically designed mobile metal trolley with drip tray. The power pack is mounted at the bottom. The components are permanently mounted on the working area. "Quick Release Couplings" are used on the components and hoses for fast and easy connections. All the components are duly fitted with "Quick Adapters" and the hoses are fitted with quick couplers. The Basic Hydraulic Trainer consists of



Specifications:

Hydraulic Power - Pack :

- * 230V/50Hz AC Motor
- * 1425 rpm 1hp AC Induction Motor
- * 3 LPM Gear Hydraulic pump
- * 100bar Pressure Gauge
- * Direct Operated Pressure Relief Valve up to 100bar with Pressure Gauge
- * Check Valve
- * Suction Filter
- * In Line Filter
- * Oil Level Indicator

- * Oil inlet Lid

Hydraulic Trainer consist of 16 slot 15x80mm Aluminum panel to accommodate all types of Hydraulic components mounted on 40x40mm Aluminum profile rack.

List Of Components

- * Hand Lever Directional Valve (4/3 way)
- * Hand Lever Directional Valve (4/2 way)
- * Direct Operated Pressure Relief Valve up to 100bar
- * Single Acting Cylinder (10cm stroke) up to 100bar
- * Double Acting Cylinder (10cm stroke) up to 100bar
- * Check Valve up to 100bar
- * Needle Control Valve
- * Flow Control Valve
- * 100bar Pressure Gauge (2 nos)
- * 4 port Manifold (2nos)
- * QRC fitted Hose Pipe (6 nos.)
- * Diaphragm Accumulator
- * Measuring Flask (2 liters)
- * Loading Weight 15Kgs

Optional Hydraulic Components

- * Pressure Reducing Valve
- * Shut off Valve
- * Sequence Valve
- * Hydraulic Motor
- * Rotameter to measure upto 4 LPM
- * Pilot Operated Pressure Relief Valve
- * Pilot Operated Check Valve
- * Counter Balance valve
- * Pressure Compensated Flow Control valve

Note: Hydraulic Oil is to provided from customer end.

Hydraulic Work Bench (optional)

MS square tube (Heavy duty) Color powder coating with rubber wood/MS table top and one pedestal drawer unit having 3 drawers, each with handles and individual locks, on metallic full panel drawer slide:

- * Work Table Size (Approx.) L1100mm X W750mm Xh760mm, with four castor wheels including two lockable wheels at the front side
- * Drawer Size (Approx.)
 - Upper & Middle Drawer L500mm x W500mm x H150mm (Each)
 - Lower Drawer : L500mm x W500mm x H200mm (Approx.)

Electro Hydraulic Trainer

Order Code - 52068C

Electro Hydraulic Trainer - 52068C is a self contained where demonstration of over 35 experiments is possible. Advance Hydraulic Trainer is a sophisticated, indigenous, new generation hydraulic teaching aid, specially developed to impart the best practical training in advanced hydraulics. It can be used as a Live Demonstrator to show functioning of various hydraulic components and control circuits. Operating pressure is kept at 20 bar for safety of the students. The components / equipments are mounted on an ergonomically designed mobile metal trolley with drip tray. The power pack is mounted at the bottom. The components are permanently mounted on the working



area. "Quick Release Couplings" are used on the components and hoses for fast and easy connections. All the components are duly fitted with "Quick Adapters" and the hoses are fitted with quick couplers. The Advance Hydraulic Trainer consists of :

Hydraulic Power - Pack :

- * Pump : 3 LPM
- * Pressure : 20 bar
- * Motor : 1/2 HP, 3 fÖ foot /flange motor
- * Oil Tank : 20 litre capacity (oil to be provided by the purchaser)
- * Suction FilterfÜ Pressure Gauge
- * Oil Level Indicator
- * Pressure Relief Valve

Components

- * Single Acting Cylinder : 40 mmfnfÖfnx 75mm - 01 No
- * Double Acting Cylinder 40mm f x100mm - 01
- * 4/2 Directional Control Valve (Spring Return) - 01 No
- * 4/2 Way Solenoid Valve - 01 No
- * 4/3 Way Directional Control Valve - 02 No
- * 4/3 Way Solenoid Valve - 01 No
- * Check Valve - 01 No
- * Diaphragm Accumulator - 01 No
- * Flow Control Valve - 01 No
- * Hydraulic Motor - 01 No
- * Manifold
 - a. Pressure Line Manifold - 01 No
 - b. Return Line Manifold - 01 No
- * Needle Valve - 01 No
- * PO Check Valve - 01 No
- * Pressure Gauge f 100 mm - 01 No
- * Pressure Reducing Valve - 01 No
- * Pressure Relief Valve - 01 No
- * Shut off Valve - 01 No
- * Sequence Valve - 01 No
- * Branch Tee - 02 No
- * Electro Magnetic Relay - 02 No
- * Electrical Limit Switch - 02 No
- * Hydraulic Hoses with Quick Couplers - 12 No
- * Loading Weight (15 Kg approx) - 01 No
- * Measuring Flask (2 litres) - 01 No
- * Pulley Arrangement (suitable to load) - 01 No
- * Push Button - 03 No
- * Proximity Sensor (Inductive) - 02 No
- * 24V DC Regulated Power Supply - 01 No

Water Level Control

Order Code - 52069



Salient Features:

Choice of 2 table top models pneumatic / Electro Pneumatic trainer (optionally) PLC may be supplied. The complete trainer mounted on table top Anodised sturdy light weight with Aluminum profile grooved plat experiment board (1070 X 700 mm) mounted slant on table option ally table with drawers arrangement to place desktop PC, oard & video monitor and caster wheel.

Specification:

Order Code - 52069 - pneumatic Trainer

Air distribution & Manual control

- * Flow & pressure Regulator (FRL) unit with Pressure gauge *(10bar) 1/4" BSP (F)
- * Manifold 4 way, 1/4"BSP (F) with ON/OFF 4 nos, ball valve.
- * One way flow control adjustable valve 1/4"BSP (F)
- * Bal Valve 1/4" BSP for ON-OFF (M-F)
- * Silencer

Control Element

- * 3/2 way directly actuated valve [with push button 1/4" BSP (F)]
- * 3/2 way mushroom button operated spring return valve 1/4" BSP (F)
- * 3/2 way roller lever actuated valve 1/4" BSP(F)
- * 5/2 way valve with selector switch 1/4"BSP (F) with 230C AC Operated
- * 5/2 way pilot operated spring return valve 1/4"BSP (F)
- * 5/2 way double pilot valve (with manual override) 1/4" BSP (F)
- * 3/2 way hand lever valve 1/4" BSP (F)
- * 2/2 way directional control valve with 230V AC operated
- * 5/3 way directional control valve mid position closed
- * Quick exhaust valve 1/4"BSP

Actuating Devices (O/P)

- * Single acting cylinder - Bore 25mm,
- * Double acting cylinder - Bore 25mm,
- * Vacuum suction generator

Logic Control

- * OR gate / shuttle valve 1/8" Bsp (F)
- * AND gate 1/8" BSP(F)

Resource Panel

- * NA

Electrical Connections

- * Mains cord with stackable connector

Pneumatic

- * Polyurethane Tube 6 X 4 = 1meter

Quick change couplers

- * 1/4" BSP female socket
- * 1/8" BSP Female socket

Order Code - 52070 - Electro pneumatic Trainer

Air distribution & Manual control

- * Flow & pressure Regulator (FRL) unit with perssure gauge (10bar), 1/4" BSP (F)
- * Manifold 4 way 1/4" BSP (F) with 4 BALL on / off valve
- * One way flow control adjustable valve 1/4"BSP (F)
- * Silencer

Control Element

- * 5/2 way DC valve spring return 1/4" BSP (F) 24VDC single Solenoid
- * 5/2 way DC valve BSP (F) 24Vdc double Solenoid
- * 3/2 way Single Solenoid valve 24V DC

Actuating Devices (O/P)

- * Single acting cylinder - Bore 25mm,
- * Double acting cylinder - Bore 25mm,

Logic Control

- * Limit Switches NC/NO.
- * Proximity switch (Inductive)

Resource Panel

- * 24V DC power supply. 8 Relay card PLC

interfaceable with NO NC contact & 24 Vdc coil, Dual Timer

- * WITH NO - NC contacts or Optionally LGLC (12 input + 8 output) with CDP and ladder software.

Electrical Connections

- * 1Meter =
- * 500 mm =
- * 100 mm =

Quick change couplers

- * 1/4" BSP female socket
- * 1/8" BSP Female socket

General Specification:

Mechanical Dimension

- * Anodised Sturdy Aluminum Profile Rack (table top) system with Aluminum Profile T grove experiment board optionally double sided.
- * Total dimension : 1165 mm (L) X 300 mm (W) X 800mm (H) NEt weight : 75 kg. / 45kh. (Electro), Gross weight 85kg. / 60 kg. (Electro)
- * Aluminum Profile Grooved J Board : L = 107cm,W = 70cm. Reclining at 0°, 20°, 30°, Height: 700mm

Air Compressor (optional)

- * Air Compressor Displa cement 3 cfm, Working pressure 7kg / cm(7 bar) with 0.5 HP 1440 rpm electric motor V / 50Hz, 1 ph. With 10bar gage & shut off valve with 8mm brass male connector hose, safety valve storage tank 35-50 Ltr.

Electro Pneumatic Trainer

Order Code - 52070A



Electro Pneumatic Trainer - 52070A, is a very versatile self - contained training package for the teachers and students in advanced pneumatics. It is designed for fail safe operation and ease of learning. Advanced Pneumatic Trainer meets the requirements of providing practical "HANDS ON" training and can be used both as an experimental kit and as a demonstrator. Various basic / advanced pneumatic circuits can be built easily due to special design of the trainer. The commonly used industrial pneumatic components and some electro - pneumatic components are provided for preparing various pneumatic circuits. many experiments can be performed. A detailed and comprehensive instruction manual is provided along with the trainer

Components:

- * Air Filter, Regulator & Lubricator Unit (FRL Unit)-01
- * Pressure Manifold with Four ON / OFF Valves for multiple connections - 01 No
- * Manifold with 3/2 Way Hand Slide Valve - 01 No
- * Single Acting Cylinder - 01 No
- * Double Acting Cylinder - 02 No
- * Double Acting Cylinder (with reed switch) - 01 No
- * 2/2 Way Direct Acting Solenoid Valve - 01No
- * 3/2 Way Disc Rotary Valve - 01 No
- * 3/2 Way Hand Lever Valve - 01 No
- * 3/2 Way Mushroom Button operated Spring Return Valve - 01 No
- * 3/2 Way Palm Operated Valve - 01 No

- * 3/2 Way Pilot Operated Valve - 01 No
- * 3/2 Way Roller Lever Valve - 01 No
- * 5/2 Way Double Pilot Valve - 01 No
- * 5/2 Way Double Solenoid Valve - 01 No
- * 5/2 Way Foot Operated Valve - 01 No
- * 5/2 Way Hand Lever Valve - 01 No
- * 5/2 Way Push Button Valve - 01 No
- * 5/2 Way Roller Valve - 01 No
- * 5/2 Way Single Pilot Spring Return Valve - 01 No
- * 5/2 Way Single Solenoid Valve - 01 No
- * 5/3 Way Hand Lever Valve - 01 No
- * Dual Pressure AND Valve - 01 No
- * Electrical Indicators (01 Unit) - 05 No
- * Electrical Limit Switch - 02 No
- * Electrical Matrix Box - 01 No
- * Electro Magnetic Relay (01 Unit) - 02 No
- * Flow Control Valve - 02 No
- * ON/ OFF Switch (01 Unit) - 02 No
- * "OR" Function Shuttle Valve - 01 No
- * Push Button Switch (01 Unit) - 03 No
- * Pressure Gauge with Tee - Piece - 01 No
- * Pneumatic Operated Time Delay Valve - 01 No
- * Pressure Regulator with Gauge - 01 No
- * PU Tubings - 10 mt
- * Proximity Sensor (inductive) - 01 No
- * Quick Exhaust Valve - 02 No
- * Silencer - 01 No
- * Time Delay Control - 01 No
- * Tee -Piece with fitting for tubing - 01 No
- * Vacuum Suction Generator - 01 No
- * 24V DC Regulated Power Supply - 01 No
- * Cable Set (Stackable Patch Cords) (assorted) - 20 No
- * Detailed Instruction Manual - 01 No

Industrial / DCS / Scada Trainer with Wireless Intelligent Controller

Order Code - 52071



Tesca' has over 3 decades of experience in the field of Industrial Automation. Add to it the knowledge & presence in Indian higher Education Market, it is this perfect blend of vast experience and knowledge which gives iDCS the edge in delivering one of the best designed Industrial Distributed Control System to train young students and the future of India. The concepts of Distributed Control Systems, SCADA and Industrial communications can be exhaustively studied using this setup.

iDCS is designed around ADAM-3600, an Intelligent Remote Controller with multiple wireless function capability, multiple I/O selection, wide temperature range & support flexible communication protocol for real world industrial applications. The Intelligent RTU controller has logic capability of usual PLC as well as latest advanced features for DCS.

The ADAM-3600 is designed for use in the Internet of Things (IoT) for Remote diagnosis, Maintenance, Visual management & Strategy Development. iDCS can also be seamlessly Integrated with SCADA for Remote Monitoring & Control.

Ease of Experimentation and Learning for students is achieved by mounting the controller on a panel with

easy access to all signals. Modular Breakout Panels for easy interfacing with simulated I/O's & with Plug in Modules (PIM's) for performing various experiments are also provided. Process mimics as well as real world applications also connect with iDCS. A suitable software package used in the industry for configuring the controller and PLC Programming languages is also included in the package.

Features:

01. Intelligent Industrial controller mounted on ESD protective Workbench
02. On-board 24V 6A Power-Supply
03. I/O Signals brought out on breakout panels for interfacing
04. PLC Programming IEC-61131-3 standards with KW-Multiprog
05. Provision for Industry standard DIN-rail mounted units
06. Examples for PLC Programming & LabVIEW based
07. Experiments Included.
08. Ergonomic Design with Ease of Interfacing

Specification:

DCS Controller

- * Powerful Platform : 32-bit Processor with Run time Engine supporting
- * IEC-61131-3 Programming Language

Protocols

- * Modbus/RTU, Modbus/TCP, DNP3

Programming

- * IEC-61131-3 SoftLogic
- * PLC Programming supports Instruction List (IL), Structured Text (ST),
- * Ladder Diagram (LD), Functional Block Diagram (FBD) & Sequential Function Chart (SFC)

Ports

- * Serial Port 1 x RS232- DB9, 1 x RS485-Terminal Block
- * Ethernet Port 2 x RJ-45 10/100 Mbps

Wireless Communication

- * WIFI Supporting 802.11bgn
- * GPRS. 15 cm External Dipole Antenna (Optional)

DCS Breakouts Panels

Analog Inputs (DE)

- * Analog Input : 8 Channel differential of DCS Controller on Banana-sockets
 - Resolution 16-bit
 - Input Type $\pm 10V / 4\sim 20mA$
 - Isolation 2,000 VDC

Digital Inputs (Sink)

- * Digital Input: 8 Channel, Sink type of DCS Controller on Banana-sockets.
 - Input Type Wet Contact, Protection Voltage +40 VDC,
 - Isolation 2,000 VDC
 - LED indicator per channel. Test-signal for Diagnostic check

Digital outputs (Sink)

- * Digital Output: 4 Channel Sink type of DCS Controller on Banana-sockets.
 - Output : Open Collector (Sink), Rated Voltage 8~30 VDC
 - Isolation 2,000 VDC
 - LED indicator per channel. Test-signal for Diagnostic check

Controller Ports

- * DCS Controller Ports terminated on

- 2 x RJ45 connector (Ethernet Ports),
- 1 x 9DTM (Serial RS-232 Port),
- 1 x 3-contact Pluggable-Screw-Terminal-Block (Serial RS-485 port)

Slot-A:

* Analog Output: 4 channels of DCS AO-Expansion Module on Banana-sockets

Analog Outputs (DE)

- Resolution 12-bit ,
- Output : VDC ± 10 V / 0~20 mA or 4~20mA (Differential)
- Isolation 3,000 VDC

Slot-B :

* Digital Input: 8 Channel, Sink type of DCS Controller on Banana-sockets.

Digital Inputs (Sink)

- Input Type Wet Contact, Protection Voltage +40 VDC,
- Isolation 2,000 VDC
- LED indicator per channel. Test-signal for Diagnostic check

Slot-C :

* Digital Output: 8Channel Sink type of DCS Controller on Banana-sockets.

Digital Outputs (Sink)

- Output : Open Collector (Sink), Rated Voltage 8~30 VDC
- Isolation 2,000 VDC
- LED indicator per channel. Test-signal for Diagnostic check

Slot-D : Expansion Mod

- * Expansion Module pre-wired on Banana-sockets for Expansion to plug in either of ;
- Analog Input Module
- Analog Output Module
- Digital Input Module
- Digital Output Module
- Thermocouple Module

And Many more...

Arduino - Internet of Things Trainer (IOT)

Order Code - 52072



Features:

The Kit includes everything you need to get started with the internet of things, including an Arduino Boards. Alphanumeric Display and Matrix Keypad, sensors and actuators. The Arduino starter kit is perfect for anyone (kids, adults or the elderly) who loves technology and wants a new geeky challenge or to get start building their own personal internet of things. You'll learn through building several creative projects. Start the basic electronics, do more complex projects, the kit will help you control the physical world with sensors and actuators This is a great kit for you to learn about Arduino and apply many smart home devices. Apart from a components list, we also provide details about the Device bit Platform including operation instructions, and 14 experiments to apply these components and learn about the related modules. Detailed materials such as module description, principle explanation and related code are provided in Manuals.

We want to use the Internet of Things to transform the way students learn about our world. Our learning materials have been designed to get educators using our kits to teach a broad swathe of subjects across Key Stages. Our current focus is getting feedback on how this new technology can help support the new computing curriculum.

Experiments:

01. How to Use GYPROSCOPE sensor Module
02. How to Use IR sensor Module
03. How to Use PIR sensor Module
04. How to Use REMOTE sensors
05. How to Use Natural Gas Sensor
06. How to Use HUMIDITY Sensor
07. How to Use Temperature Sensor
08. How to Use GSM MODEM Module
09. How to Use RFID TX and RX 315MHz Module
10. How to Use XBEE Module
11. How to Use Voice Recognition Module
12. How to Use Ultrasonic Sensor Module
13. How to Use Magnetic compass Sensor
14. How to Use Camera Module

Arduino Development Board

Order Code - 52072A



52072A Experimental Set Up has been designed specifically for beginners to learn Arduino and apply it in embedded applications. The board contains the necessary components and sensors that covers the basic as well as advanced areas of embedded system. All the practical can be implemented using Arduino Programming Language which is an open source project with codes & library available on github. Practical experience on this set up carries great educative value for Science and Engineering Students

Object:

To develop Arduino program for

01. Blinking of LED.
 - Controlling LED arrays.
02. Controlling LED using Push button.
03. Interfacing 20x4 LCD.
04. Interfacing 7 segment display.
05. Generating tone using buzzer.
06. Designing Real time Clock using DS1307 IC.
07. Control DC motor.
08. Interfacing 4x4 keypad matrix.
09. Sensing environment humidity by interfacing humidity sensor DHT11.
10. Measuring distance by interfacing ultrasonic sensor HC-SR04.
11. Sensing smoke & its level by interfacing Smoke sensor MQ-135.
12. Sensing temperature by interfacing Lm35 temperature sensor.
13. Interfacing LDR.

Features:

The board consists of the following:

01. +5V & +3.3V D.C. at 100mA, IC regulated power supply internally connected.

02. Arduino UNO Board with USB port for up loading programming and data communication.
03. 20x4 LCD for displaying output values.
04. 4 digit seven segment display for displaying output values.
05. 8 push buttons for controlling LED or to use it as an input unit.
06. 8 LED for indicating output.
07. Buzzer for indicating output or to generate tone.
08. BREAD BOARD One Terminal Strips with 640 tie points and 2 Distribution Strips with 100 tie points each, totaling to 840 tie points. For further expansion.
09. DS1307 IC to be used as Real Time Clock
10. L293D Dual H-Bridge Motor Driver IC with two 5V DC motor.
11. MAX232 IC with DB9 Connector for serial port communication.
12. Humidity Sensor DHT11.
13. Ultrasonic Sensor HC-SR04.
14. Gas/Smoke/Alcohol Sensor MQ-135.
15. Temperature Sensor LM35.
16. LDR.
17. 4x4 Keypad Matrix.
18. Weight : 3.0 Kg. (Approx.)
19. Dimension : W 415 x H 165 x D315

Accessories:

01. CD with programs and software.
02. Mains Lead.
03. RS-232 Cable.
04. Arduino Cable.
05. Operating Instruction Manual.

Other Apparatus

01. Cathode Ray Oscilloscope 20MHz (CRO).
02. PC System with Windows 7, 8, 8.1 or 10 with 32 or 64 bit Operating System.

Different Type Sensor's Trainer And Modules

Order Code - 52072A.11 to 52072A.31

52072A.11 to 52072A31: Sensors Trainer Board is an excellent learning tool for starters for studying different types of sensors & interfacing them with Atmega328 microcontroller using Arduino Programming. The board could be ideal training systems for learning "How sensors value could be read using microcontroller" The training kit has been enriched by the ideas of students who have put their inputs in designing/developing the same. System housed in attractive enclosure is supplied 5 volt adapter as power supply and instruction manual and no other accessories / equipments required.

52072A.11 Soil Moisture Sensor Trainer

- * Detection of percentage of moisture in any sample of soil.

52072A.12 Distance Measurement Trainer

- * Measurement of distance using ultrasonic sensor by transmitting/receiving ultrasonic waves.

52072A.13 Temperature Sensor Trainer

- * Determination of temperature of hot/cold object in Celsius Scale

52072A.14 Humidity Sensor Trainer

- * Measurement of dampness/humidity or present of water vapour in atmospheric air.

52072A.15 Human Detection Trainer

- * Live Human/Animal detection by motion sensing.

52072A.16 Gas Leakage Detector Trainer

- * Detection of Gas leakage with alert & alarm.

52072A.17 Fire Detection Trainer

- * Fire Detection with alarm

52072A.18 Biometric Pressure Sensor Trainer

- * Measurement of environmental air pressure & temperature.

52072A.19 IR Sensor Trainer

- * Measurement of speed of fan (Digital Tachometer)

52072A.20 Tilt Detector Trainer

- * Tilt Detection along with direction

52072A.21 DC Motor Control Trainer

- * Speed Control of DC motor by tilting the sensor.

52072A.22 Alcohol Level Detector Trainer

- * Measure the level of alcohol consumed by sensing human breathe.

52072A.23 Smoke Detector Trainer

- * Measure the volume of smoke present in any environmental condition.

52072A.24 Multi Color Generator Trainer

- * Generation of huge number of color lights LED for decoration

52072A.25 Sound Intensity Measurement Trainer

- * Measurement the sound level, intensity and loudness.

52072A.26 Magnetic Field Detector Trainer

- * Detection of presence of magnetic field.

52072A.27 UV Ray Intensity Measurement Trainer

- * Measurement of intensity of UV light

52072A.28 Liquid Detector Trainer

- * Detection of Water or any liquid

52072A.29 RFID Based Security System Trainer

- * RFID based Door Locking/opening Security System.

52072A.30 Color Sensor Trainer

- * Determination of frequency of various colors and determining color.

52072A.31 Rain Fall Detector Trainer

- * Detection of rain and quantity of rain fall

Board Consist Of Following Part

01. 16*2 LCD for result display or LED/Buzzer for result indication
02. Reset Switch .
03. Detail operating instruction manual.

Features:

01. Weight : 200 Grams
02. Dimension : W 176 x H 131 x D 50mm

Raspberry Application Board

Order Code - 52072B.



Specification:

- * RASPBERRY PI 3 MODEL B+
 - Broadcom BCM2837B0, Cortex-A53 (ARMv8) 64-bit SoC @ 1.4GHz

- 1GB LPDDR2 SDRAM
- 2.4GHz and 5GHz IEEE 802.11.b/g/n/ac wireless LAN, Bluetooth 4.2, BLE
- Gigabit Ethernet over USB 2.0 (maximum throughput 300 Mbps)
- Extended 40-pin GPIO header
- Full-size HDMI
- 4 USB 2.0 ports
- CSI camera port for connecting a Raspberry Pi camera DSI display port for connecting a Raspberry Pi touchscreen display
- 4-pole stereo output and composite video port
- Micro SD port for loading your operating system and storing data
- 5V/2.5A DC power input
- Power-over-Ethernet (PoE) support (requires separate PoE HAT)
- * On Board Applications
 - 4 Input Switches to give Digital Input
 - 4 LEDs to display Digital Output
 - 4 digit Seven segment displays
 - 16*2 Alphanumeric LCD
 - Miniature Buzzer
 - 12V SPDT Relay
 - Fingerprint Sensor Module
 - RFID Sensor Module
 - Neo 6m v2 GPS Module
 - 16 Bit I2C 4 Channel ADC using ADS1115 module
 - 40 Pin GPIO Extension Board for Raspberry Pi
 - Pilot lamp Indicator
 - Pi camera Module
 - USB to Serial converter
 - DC Motor
 - 600 Tie Points Bread Board Area provided
- * Interconnection
 - All interconnections are made using 0.8mm Single stand wires.
- * Test points are provided to analyze signals at various points.
- * All ICS are mounted on IC Sockets.
- * Bare board Tested Glass Epoxy SMOBC PCB is used.
- * In-Built Power Supply of 3.3V,+5V & +12V with Power ON indication
- * Attractive ABS Plastic enclosures
- * Set of 0 . 8mm single stand wires for interconnections

List of Experiments:

01. Starting Raspbian OS, Familiarising with Raspberry Pi Components and interface, Connecting to ethernet, Monitor, USB.
02. Displaying different LED patterns with Raspberry Pi
03. Displaying Time over 4-Digit 7-segment Display using Raspberry Pi.
04. Setting up Wireless Access Point using Raspberry Pi
05. Fingerprint Sensor interfacing with Raspberry Pi
06. Raspberry Pi GPS Module Interfacing
07. IoT based Web Controlled Home Automation using Raspberyy Pi.
08. Visitor Monitoring with Raspberry Pi and Pi Camera.
09. Interfacing Raspberry Pi with RFID.
10. Building Google Assistant with Raspberry Pi.
11. Installing Windows 10 IoT Core on Raspberry Pi.

Arduino Application Board

Order Code - 52072C



Specification:

- * ARDUINO UNO/MEGA BOARD
 - Microcontroller ATmega328
 - Operating Voltage 5V
 - Input Voltage (recommended) 7-12V
 - Input Voltage (limits) 6-20V
 - Digital I/O Pin14 (of which 6 provide PWM output)
 - Analog Input Pins 6
 - DC Current per I/O Pin 40 mA
 - DC Current for 3.3V Pin 50 mA
 - Flash Memory 32 KB (ATmega328) of which 0.5 KB used by bootloader
 - SRAM 2 KB (ATmega328)
 - EEPROM 1 KB (ATmega328)
 - Clock Speed 16 Mhz
- * On Board Applications
 - 4 Input Switches to give Digital Input
 - 4 LEDs to display Digital Output
 - 4 digit Seven segment displays
 - 16*2 Alphanumeric LCD
 - Miniature Buzzer
 - 12V SPDT Relay
 - Fingerprint Sensor Module
 - RFID Sensor Module
 - Neo 6m v2 GPS Module
 - 16 Bit I2C 4 Channel ADC using ADS1115 module
 - 40 Pin GPIO Extension Board for Arduino
 - Pilot lamp Indicator
- * Interconnection
 - All interconnections are made using 0.8mm Single stand wires.
- * Test points are provided to analyze signals at various points.
- * All ICS are mounted on IC Sockets.
- * Bare board Tested Glass Epoxy SMOBC PCB is used.
- * In-Built Power Supply of 3.3V,+5V & +12V with Power ON indication
- * Attractive ABS Plastic enclosures
- * Set of 0.8mm single stand wires for interconnections

List of Experiments:

01. Starting and connecting Arduino board with Computer
02. Displaying different LED patterns with Arduino · LCD interfacing with Arduino
03. DC Motor Interfacing with Arduino
04. Buzzer & relay interfacing with arduino
05. Displaying Time over 4-Digit 7-segment Display using Arduino
06. Fingerprint Sensor interfacing
07. GPS Module Interfacing
08. Visitor Monitoring with Camera interfacing.

PLC - Trainer

Order Code - 52073



Features:

01. The PLC Application Trainer provides a complete, structured solution to the problem of training today's industrial control engineers & technicians in the programming & troubleshooting of PLC applications.
02. Rugged and reliable, the trainer's flexible design allows it to be used in both Introductory & Advanced PLC applications.
03. The System includes an Industrially Relevant Applications Trainer, An Industry Standard PLC, A Sequence Switch Module, A compressed air pump and Curriculum manual.
04. These features make PLC particularly suitable for Training & multi-skilling courses.

Specifications:

The PLC Module comprises:

- * PLC Applications trainer with Conveyor belt having forward & reverse directions.
- * Three Pneumatically Controlled Pistons, for pushing parts off the conveyor.
- * Two sets of infra-red Parts sensors.
- * Set of Cylindrical Parts along with Parts bin for sorting parts into different categories.
- * Run / Stop switches with Indicator lamps.
- * Seven SPDT Switches which can be used to manually control the inputs of the PLC, in order to simulate a various Input Conditions.
- * On board Sensors indication LEDs
- * On Board 10K Knob Potentiometer A(0-10V)

The SIMATIC S7-1200, CPU 1214C, COMPACT CPU, DC/DC/DC controller, ONBOARD I/O: 14 DI 24V DC; 10 DO 24 V DC; 2 AI 0 - 10V DC, Timers, and Counters & Sequencer Functions.

The controller is supplied with Programming Software, which is used to Program, Monitor, Edit & Troubleshoot Sequences for practical exercises.

An Interface RJ45 cable that connects the controller to the computer is included.

Electrically Operated compressed air pump provides a safe source of compressed air.

The PLC application trainer enables students to create Sequences which simulate the operation of a modern Industrial Production line

Typical activities around PLC Includes :

- * Identify Hard Wired Ladder & PLC Ladder Logic diagrams and its operation.
- * Investigate the operation of a Ladder Logic Program.
- * Investigate the operation of Examine ON, Examine OFF & Output Energize instructions and their operation

- * Identify the operation of Latching and Self-Latching Relays.
- * Recognize the Retentive Timer ON and RESET instructions and how they are programmed.
- * Recognize the Bit Shift Left and Bit Shift Right instructions and how they are programmed.
- * Recognize the operation of the Sequencer Output instruction and how it is programmed.
- * Write a program to Sort components by Height.
- * Write a program to Sort components by Width.
- * Produce a complete processing system program.

The PLC covers following topic areas:

- * Introduction to Programmable Logic Controllers
- * Relays and Relay Ladder Logic
- * Introduction to Ladder Logic Programming
- * Basic Programming Instructions
- * Latches and Master Control Reset (MCR) Instructions
- * Timers
- * Counters and Shift Registers
- * Sequencers
- * Programming the Complete System

The Manual covers all relevant topic areas & provides background theory, practical activities and assessment questions.

The Supplied Curriculum Manual, Student workbook & Instructor's guide helps to cover background theory, practical activities and assessment questions with respect to above topics.

Ordering Info

PLC : ACCS SET PLC & Its Application
 Training System : SIEMENS PLC with all accessories for above

Pressure Measurement with Pressure Generator

Order Code - 52081

Features:

- * Transducer
 - Resistive Pressure Transducer with transparent enclosure.
 - Pressure of 0-300mm hg / 6psi
 - Primary Excitation voltage of 5V DC
- * Measurement Options
 - On-board Digital Panel Meter provided
 - Output available on 2mm Banana sockets for Monitoring
 - Pressure generation and Monitor using a Mercury gauge manometer
- * Onboard Features
 - Provided with excitation voltage
 - Onboard Instrumentation Amplifier provided
 - Block Description Screen printed on glassy epoxy PCB
 - Facility to Interface with PC (Optional)
 - Facility to Interface with 8085/86/51 kit(Optional)
- * Interconnections
 - All interconnections are made using 2mm banana Patch cords.
- * Test points are provided to analyze signals at various points.
- * All ICS are mounted on IC Sockets.
- * Bare board Tested Glass Epoxy SMOBC PCB is

Used.

- * In-Built Power Supply of +5V/1.5A, ±12V/250mA with Power ON indication
- * Attractive Wooden enclosures of Light weight Australian Pine Wood.
- * Set of 2mm Patch cords for interconnections
- * User's Manual with sample experimental programs

Level Measurement Trainer

Order Code - 52082



Specifications:

- * Transducer /Sensor
 - Capacitive Level Transducer.
 - Level Measurement up to 150mm is Possible
- * Measurement Options
 - On-board Digital Panel Meter provided
 - Output available on 2mm Banana sockets for Monitoring
 - Scale for level measurement
- * Onboard Features
 - Onboard Instrumentation Amplifier provided
 - Block Description Screen printed on glassy epoxy PCB
 - 1feet Scale is provided for level measurement
 - Plastic container with outlet Tap is provided for Water Storage
 - Facility to Interface with PC (Optional)
 - Facility to Interface with 8085/86/51 kit (Optional)
- * Interconnections
 - All interconnections are made using 2mm banana Patch cords.
- * Test points are provided to analyze signals at various points.
- * All ICS are mounted on IC Sockets.
- * Bare board Tested Glass Epoxy SMOBC PCB is used.
- * In-Built Power Supply of +5V/1.5A, ±12V/250mA with Power ON indication
- * Attractive enclosure
- * Set of 2mm Patch cords for interconnections User's Manual with sample experimental Programs

Speed Measurement Trainer

Order Code - 52083



Specifications:

- * Transducer /Sensor
 - Magnetic Pick-up Transducer is used.
 - Photo Pick up Transducer is also used
- * Measurement Options
 - On-board Digital Panel Meter provided
 - Output available on 2mm Banana sockets for Monitoring
- * Onboard Features
 - Onboard Instrumentation Amplifier provided
 - Block Description Screen printed on glassy epoxy

PCB

- 6V DC Motor with necessary attachment for measurement is provided
- * Interconnections
 - All interconnections are made using 2mm banana Patch cords.
- * Test points are provided to analyze signals at various points.
- * All ICS are mounted on IC Sockets.
- * Bare board Tested Glass Epoxy SMOBC PCB is used.
- * In-Built Power Supply of +5V/1.5A, ±12V/250mA with Power ON indication
- * Attractive enclosure
- * Set of 2mm Patch cords for interconnections
- * User's Manual with sample experimental programs

Angular Displacement Trainer

Order Code - 52084

Features:

- * Transducer
 - Capacitive Level Transducer.
 - Resistive Transducer using multi turn potentiometer.
 - Angular Measurement of 0° to 360°.
- * Measurement Options
 - On-board Digital Panel Meter provided.
 - Output available on 2mm Banana sockets for Monitoring.
 - Protractor for angle measurement
- * Onboard Features
 - Onboard Instrumentation Amplifier provided.
 - Block Description Screen printed on glassy epoxy PCB.
 - On board Protractor for angle measurement.
 - Facility to Interface with PC (Optional).
 - Facility to Interface with 8085/86/51 kit(Optional).
- * Interconnections
 - All interconnections are made using 2mm banana Patch cords.
- * Test points are provided to analyze signals at various points.
- * All ICS are mounted on IC Sockets.
- * Bare board Tested Glass Epoxy SMOBC PCB is used.
- * In-Built Power Supply of +5V/1.5A, ±12V/250mA with Power ON indication.
- * Attractive Wooden enclosures of Light weight Australian Pine Wood.
- * Set of 2mm Patch cords for interconnections
- * User's Manual with sample experimental programs.

Sensor Trainer Board (ITI)

Order Code - 52085



52085 is a Sensor Trainer offer Complete training opportunity for most commonly used Sensor available for experimenting in the Laboratory. Due to the typical Strength obtain from a sensor is not enough to process the signal; this board provides signal Conditioners with

Digital panel meter for display.

Specifications:

- | On-board Digital Panel Meter provided
- | Measuring range of +/-1V
- | Input available on 2mm Banana sockets

RPM Meter:

- * Digital RPM Meter
- * Input available on 2mm Banana sockets

LVDT Transducer:

- * LVDT Transducer with transparent enclosure.
- * Displacement of ± 5mm
- * Primary Excitation voltage of Sine wave 1V p-p.
- * Signal Conditioning Amplifier
- * LVDT transparent With Screw Gauge unit

Strain / Load Cell Transducer:

- * Resistive Load cell is used.
- * Load/Strain in weights can be measured up to 3 Kgs.
- * Primary Excitation voltage of 12V DC
- * Signal Conditioning Amplifier
- * Cantilever Load Cell platform Unit for Strain & Load Cell Setup
- * Weight unit up to 3Kgs

Temperature Sensor:

- * K-type Thermocouple is used.
- * PT-100 Type RTD sensor is used
- * LM335 Sensor.
- * Thermistor Sensor

Signal Conditioning Amplifier:

- * Heater, Thermometer, Transparent Jar unit for Temperature setup

Speed Sensor:

- * Proximity Switch is used for Magnetic Pickup.
- * DC Motor with Proximity Switch for Speed Measurement Setup

Smoke Sensor:

- * MQ2 Smoke Sensor.
- * Buzzer for Alarm

Signal Conditioning & Amplifier:

- * Instrumentation amplifier
- * All interconnections are made using 2mm socket.
- * Test points are provided to analyze signals at various points.
- * All ICS are mounted on IC Sockets.
- * Bare board Tested Glass Epoxy SMOBC PCB is used.
- * In-Built Power Supply of ±5V, ±12V.
- * Attractive Metal Enclosure
- * User Manual for Experiments.

Flow Rate Measurement Trainer

Order Code - 52086



Flow Rate measurement using a Rotameter exposes student and industry professionals to fundamentals of flow rate measurement. Its demonstrates how a Rotameter can measure flow rate of water.

Features:

01. User friendly, self explanatory system.
02. Leak proof safety measures, study piping.
03. Enhanced electrical safety consideration.
04. Training manual for operation ease.
05. M.S. right angle platform with standard instrument mounting.

Technical Specifications:

- Pump : 1/2 HP, 230 V AC
- Rotameter : Range: 0 to 2000 LPH
- Type : Glass tube type / Acrylic body
- Connection : Vertically placed back body
- Mounting : Inlet - bottom, Outlet - top
- Piping : 20mm (3/4") CPVC 20mm (3/4") Flexible
- Water Tap : Inlet, Outlet - 20mm (3/4")
- Power Supply : 230V, 50Hz
- Dimensions : W609 X D330 X H533
- Weight : 10Kg (approximately)

Experiments:

01. Study of flow rate.
02. Study of Rotameter.
03. Study and use of flow rate measurement of water using a Rotameter

Process Flow Diagram

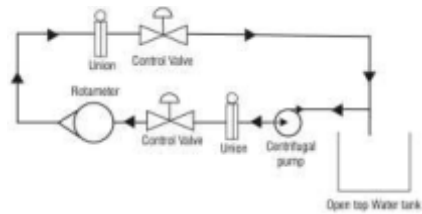

Basic Pneumatic Trainer Kit (Transparent) With Inclined Profile

Order Code - 52101



SN.	Item Description	Qty.
1	Air preparation unit	1
2	Junction box with slide valve	1
3	Double acting cylinder Tie rod model	1
5	Single acting cylinder Tie rod model	1
6	Roller Lever valve	3
7	Inline flow control valve	2
8	5/2 way double external pilot operated valve	1
9	5/2 way Single External pilot operated valve with spring return	1
10	5/2 Hand lever valve with detent	1
11	Pneumatic text book	1
12	Pneumatic exercise book - Basic	1

Basic Pneumatic Trainer Kit With Inclined Profile

Order Code - 52102 - 52102A



Basic pneumatic package

- * This is a mandatory basic package that includes basic pneumatic products like Air cylinder, FRL, Multi distributor units, One touch fittings, Final control elements, Tubes etc.,
- * Function of air preparation units filter, regulator and lubricator
- * One touch fittings and tubing for easy connect and disconnect

SN.	Item Description	Quantity
01.	FRL Unit with pressure gauge	1
02.	Junction box with Slide valve	1
03.	Flow control valve unit	4
04.	Single acting cylinder (SAC)	1
05.	Double acting cylinder (DAC)	2
06.	Union tee Dia4	4
07.	Union Y Dia4	4
08.	Plug Dia4	6
09.	Tube (PU) OD8 (blue)	5 meters
10.	Tube (PU) OD4 (blue)	10 meters
11.	Tube cutter	1

Basic pneumatic add on module

- * Includes basic pneumatic products like directional control valves, logic elements, mechanically actuated valves etc.,
- * Operation of single acting and double acting cylinder
- * Speed control techniques of pneumatic actuator
- * AND, OR logic operation
- * Position control using Roller lever valve
- * Operation of manual operated valves
- * Function of Quick Exhaust valve

SN.	Item Description	Qty.
01.	3/2 NC Push Button (Green) Valve	1
02.	3/2 NC Push Button (Red) Valve	1
03.	5/2 Double external pilot operated valve	4
04.	5/2 External pilot operated valve with Spring return	1
05.	5/2 Hand lever operated valve with spring return	1
06.	5/2 Hand lever operated valve with Detent	1
07.	Shuttle valve (OR Valve)	2
08.	Quick Exhaust valve	1
09.	Dual pressure valve (AND Valve)	1
10.	Multi distributor fittings (for cascading)	3
11.	5/2 Valve with Lever head switch	1
12.	5/2 Valve with Mushroom head switch	1
13.	M5 Roller lever valve (Forwarding)	2
14.	M5 Roller lever valve (Reversing)	2
15.	Pneumatics - Text book	1
16.	Pneumatics - Exercises	1

Only for 52102A

Advanced pneumatic add on module

- * Includes advanced pneumatic products like pneumatic timer, etc.,

- * Time delay operations
- * Mid position control using Idle roller lever valve
- * Creation of advanced pneumatic circuits

SN.	Item Description	Quantity
1.	5/3 Double external pilot operated valve with spring centered	1
2.	Idle return valve assembly - Forwarding	1
3.	Time delay valve	4

Advanced Electro Pneumatic Trainer Kit With Inclined Profile

Order Code - 52103 - 52103A



Basic pneumatic package

- * This is a mandatory basic package that includes basic pneumatic products like Air cylinder, FRL, Multi distributor units, One touch fittings, Final control elements, Tubes etc.,
- * Function of air preparation units filter, regulator and lubricator
- * One touch fittings and tubing for easy connect and disconnect

SN.	Item Description	Quantity
01.	FRL Unit with pressure gauge	1
02.	Junction box with Slide valve	1
03.	Flow control valve unit	4
04.	Single acting cylinder (SAC)	1
05.	Double acting cylinder (DAC)	2
06.	Union tee Dia4	4
07.	Union Y Dia4	4
08.	Plug Dia4	6
09.	Tube (PU) OD8 (blue)	5 meters
10.	Tube (PU) OD4 (blue)	10 meters
11.	Tube cutter	1

Basic electro pneumatic package

- * Includes basic electro pneumatic products like solenoid valves, magnetic sensors etc.,
- * Solenoid valves for actuator control
- * Position sensing using magnetic sensors
- * Operation of signal elements
- * Cables with banana plugs for easy connect & disconnect
- * Creation of basic electro pneumatic circuits

SN.	Item Description	Qty.
1.	5/2 Single solenoid operated valve with spring Return (with LED)	1
2.	5/2 Double solenoid operated valve (With LED)	2
3.	Magnetic sensor with clamp for Miniature cylinder	6
4.	Electrical Connection set	1
5.	Electrical push button module	1

Basic electro pneumatic add on module

- * Includes basic electro pneumatic products like relay etc.,
- * Latching of solenoid coils using Relay
- * Function of 4C/O Relay

- * Understanding of Latching circuits
- * Creation of basic electro pneumatic circuits using relay

SN.	Item Description	Qty.
01.	Relay logic unit - 4C/O - 3 Relays	2
02.	Electro Pneumatics - Exercises	1

Only for 52103A

Advanced electro pneumatic add on module

- * Includes advanced electro pneumatic products like electrical timer and counter etc.,
- * Functions of ON delay & OFF Delay timer
- * Pulse counting using Counter
- * Operation of Various types of proximity sensors - inductive, capacitive, Photo electric
- * Creation of advanced electro pneumatic circuits

SN.	Item Description	Qty.
01.	Inductive proximity sensor assembly	1
02.	Capacitive proximity sensor assembly	1
03.	Optical proximity sensor assembly	1
04.	Electrical counter module	1
05.	Electrical buzzer with indicator module	1
06.	ON & OFF delay timer module	1

Advanced Electro Pneumatic Trainer Kit PLC With Inclined Profile

Order Code - 52104 - 52104A



Basic pneumatic package

- * This is a mandatory basic package that includes basic pneumatic products like Air cylinder, FRL, Multi distributor units, One touch fittings, Final control elements, Tubes etc.,
- * Function of air preparation units filter, regulator and lubricator
- * One touch fittings and tubing for easy connect and disconnect

SN.	Item Description	Quantity
01.	FRL Unit with pressure gauge	1
02.	Junction box with Slide valve	1
03.	Flow control valve unit	4
04.	Single acting cylinder (SAC)	1
05.	Double acting cylinder (DAC)	2
06.	Union tee Dia4	4
07.	Union Y Dia4	4
08.	Plug Dia4	6
09.	Tube (PU) OD8 (blue)	5 meters
10.	Tube (PU) OD4 (blue)	10 meters
11.	Tube cutter	1

Basic electro pneumatic package

- * Includes basic electro pneumatic products like solenoid valves, magnetic sensors etc.,
- * Solenoid valves for actuator control
- * Position sensing using magnetic sensors
- * Operation of signal elements
- * Cables with banana plugs for easy connect & disconnect

- * Creation of basic electro pneumatic circuits

SN.	Item Description	Qty.
01.	5/2 Single solenoid operated valve with spring Return (with LED)	1
02.	5/2 Double solenoid operated valve (With LED)	2
03.	Magnetic sensor with clamp for Miniature cylinder	6
04.	Electrical Connection set	1
05.	Electrical push button module	1

Only for 52104A

Advanced PLC add on module

- * Includes Siemens S7-200 PLC / equivalent with software and accessories
- * Control of electro pneumatic components using PLC
- * Hardwired PLC with a proprietary I/O interface for banana plug connections
- * Provision for OPC interface
- * Real time communication

SN.	Item Description	Qty.
01.	PLC module (S7-200)	1
02.	PLC programming software	1
03.	PLC programming cable	1
04.	PLC Exercise book	1

Basic Pneumatic Trainer Kit With Fixed Component

Order Code - 52105



The pneumatic trainer kit is designed with capability to demonstrate the design, construction and application of pneumatic components and circuits.

SN.	Item Description	Qty.
01.	Air preparation unit	1
02.	Junction box with slide valve	1
03.	Double acting cylinder Tie rod model	1
04.	Double acting cylinder – Crimping model	1
05.	Single acting cylinder – Crimping model	1
06.	Roller Lever valve	4
07.	Inline flow control valve	5
08.	5/2 way double external pilot operated valve	3
09.	5/2 way Single External pilot operated valve with spring return	1
10.	5/2 Hand lever valve with Sp. return	1
11.	5/2 Hand lever valve with detent	1
12.	3/2 NC Valve with switch(Flush head - Green)	1
13.	3/2 NC Valve with switch(Flush head - Red)	1
14.	Quick exhaust valve	1
15.	OR Valve	1
16.	AND Valve	1
17.	Pneumatic text book	1
18.	Pneumatic exercise book - Basic	1

Electro Pneumatic Trainer Kit With Fixed Component

Order Code - 52106



The pneumatic trainer kit is designed with capability to demonstrate the design, construction and application of pneumatic components and circuits, Design and function of a Electro pneumatic system.

SN.	Item Description	Qty.
01.	Air preparation unit	1
02.	Junction box with slide valve	1
03.	Double acting cylinder – Tie rod model	1
04.	Double acting cylinder – Crimping model	1
05.	Single acting cylinder – Crimping model	1
07.	Inline flow control valve	5
08.	5/2 way Double solenoid operated valve	2
09.	5/2 way Single solenoid operated valve with spring return	2
10.	4 C/O Relay	2
11.	Electrical push button with selector switch	1
12.	Electro pneumatic text book	1
13.	Electro pneumatic exercise book - Basic	1

Electro Pneumatic Trainer Kit PLC With Fixed Component

Order Code - 52107



The "Electro pneumatic kit with PLC" consists of all the capabilities mentioned under the electro pneumatic training kit, as well as surpasses their capabilities by its flexibility in designing circuits & possibilities of achieving numerous logical circuits using the software interface, with no need for alterations in the connections given to the sensors / actuators.

SN.	Item Description	Qty.
01.	Air preparation unit	1
02.	Junction box with slide valve	1
03.	Double acting cylinder – Tie rod model	1
04.	Double acting cylinder – Crimping model	1
05.	Single acting cylinder – Crimping model	1
07.	Inline flow control valve	5
08.	5/2 way Double solenoid operated valve	2
09.	5/2 way Single solenoid operated valve with spring return	2
10.	Logo PLC assembly	1
11.	Logo programming software	1
12.	Logo programming cable	1
13.	Electrical push button with selector switch	1
14.	Electro pneumatic text book with PLC	1
15.	Electro pneumatic exercise book with PLC - Basic	1

Wall Posters

Order Code - 52146



Matt Laminated Wall Mounted Colour photos Includes:

- * Classification of Pneumatic Elements
- * Working Elements
- * Final Control Elements
- * Signal Elements
- * Directional Control Valves
- * Air Preparation Units
- * ISO Symbols - Air Preparation Units, Working Elements, Supplementary Elements

Cut section

Order Code - 52147



- * Single acting cylinder
- * Double acting cylinder
- * Filter regulator
- * Hand lever valve
- * Flow control valve
- * AND valve
- * OR valve
- * 3/2 NC flush head valve with actuator - Green
- * Quick exhaust valve
- * Non return valve
- * Double external pilot operated valve

Magnetic Symbols

Order Code - 52148



Includes ISO symbols of:

- * Air Preparation Units
- * Signal Elements
- * Directional Control Valves
- * Working Elements
- * Final Control Elements
- * Accessories

Animation Software for Pneumatics

Order Code - 52149



This software package is developed keeping in mind that this should be a handy tool for the trainers in Educational Training Institutes & Corporate Training Centers to go hand in hand with the latest in the industry. With this software

- * Functional features of products & components can be understood
- * The virtual cut sectional animations of individual components and as a circuit lets the students toknow the internal details of the product and to understand the functions better.

- * Trainers can explain about the products and can educate the students at a very short period, so as to have ample time on using trainer kits to gain more practical knowledge.
- * Flow calculator and cylinder selection module are incorporated with this software to guide the selection of pneumatic components for both industrial and educational projects.

Modular Production / Manufacturing System

Order Code - 52200



Main Unit - 52200

These Mechatronics systems are fully functional models of actual applications, mimicking hybrid, real life, industrial automation scenarios. Various Automation and Handling Task modules such as feeding, conveying, pick & place, transporting, forming and storage modules are available. Wide range of Modular Manufacturing Systems like, Dispensing Station, Inspection Station, Buffer Station, Processing Station, Sorting Station are suitable for modular assembly are available. A wide variety of project assignments and learning objectives help students to build hybrid systems by integrating important automation technologies, such as Pneumatics, Electrical, PLC, Mechanical, Sensors.

- * Dispensing Station : Stack magazine and vacuum switch module for distribution of work piece for inspection
- * Inspection Station: Pneumatic linear drive fitted with linear transducer measures the height of work piece and segregates the approved / rejected ones
- * Buffer Station: Holds a buffer stock of maximum 5 work pieces and feeds them to the processing station
- * Processing Station: Demonstrates processes like drilling, inspection and transfer of finished component to the next station
- * Sorting Station: Finished components are sorted to the appropriate bay based on their material and colour
- * Pneumatics
- * Electrical
- * PLC
- * Mechanical
- * Sensors

Feeder station - 52200A



Technical Specification:

Size (in cm) : 54x70x134
 Installation : Vertical
 Ambient temperature : 60°C Max.
 Medium : Filtered Compressed air
 Operating Pressure

range (Bar) : 6-8 bar
 Operating Voltage +/- 10% : 230V AC, 50HZ
 Power consumption : 180 W (224 VA)
 Sensors and actuator operating voltage : 24V, DC
 Material of construction : Aluminum, mild steel, Plastic.etc

SN.	Item Description	Qty.
01.	Horizontal profile table work bench	1
02.	Stack magazine module	1
03.	Changer module	1
04.	Valve manifold assembly	1
05.	Compact ejector assembly	1
06.	IO Interface module with 25 pin D Sub connector.	1
07.	FRL Assembly	1
08.	PLC panel assembly - Siemens PLC (S7-1200) with 14 DI/10 DO & Integrated power supply	1
09.	Acrylic Door assembly with magnetic lock	1
10.	Control console assembly	1
11.	Cable duct and accessories	1
12.	Work book for Feeder station	1

Inspection Station - 52200B



Technical Specification:

Size (in cm) : 68x64x135
 Installation : Vertical
 Ambient temperature : 60°C Max.
 Medium : Filtered Compressed air
 Operating Pressure range (Bar) : 6-8 bar
 Operating Voltage +/- 10% : 230V AC, 50HZ
 Power consumption : 180 W (224 VA)
 Sensors and actuator operating voltage : 24V, DC
 Material of construction : Aluminum, mild steel, Plastic.etc.

SN.	Item Description	Qty.
01.	Horizontal profile table work bench	1
02.	Measuring module with LVDT	1
03.	Slide module with approved and rejection slide	1
04.	Valve manifold assembly	1
05.	IO Interface module	1
06.	FRL Assembly	1
07.	PLC panel assembly - Siemens PLC (S7-1200) with 14 DI/10 DO, Analog input module with 4 inputs & Integrated power supply	1
08.	Control console assembly	1
09.	Cable duct and accessories	1
10.	Acrylic Door assembly with magnetic lock	1
11.	Work book for Inspection station	1

Buffer Station - 52200C



Technical Specification:

Size (in cm) : 55x64x106
 Installation : Vertical
 Ambient temperature : 60°C Max.
 Medium : Filtered Compressed air
 Operating Pressure range (Bar) : 6-8 bar
 Operating Voltage +/- 10% : 230V AC, 50HZ
 Power consumption : 180 W (224 VA)
 Sensors and actuator operating voltage : 24V, DC
 Material of construction : Aluminum, mild steel, Plastic.etc.

SN.	Item Description	Qty.
01.	Horizontal profile table work bench	1
02.	Conveyor assembly with DC brushless motor	1
03.	Valve manifold assembly	1
04.	IO Interface module	1
05.	FRL Assembly	1
06.	PLC panel assembly - Siemens PLC (S7-1200) with 14 DI/10 DO, DC brushless motor driver unit & Integrated power supply	1
07.	Control console assembly	1
08.	Acrylic Door assembly with magnetic lock	1
09.	Cable duct and accessories	1
10.	Workbook for Buffer station	1

Process Station - 52200D



Technical Specification:

Size (in cm) : 72x64x141
 Installation : Vertical
 Ambient temperature : 60°C Max.
 Medium : Filtered Compressed air
 Operating Pressure range (Bar) : 6-8 bar
 Operating Voltage +/- 10% : 230V AC, 50HZ
 Power consumption : 180 W (224 VA)
 Sensors and actuator operating voltage : 24V, DC
 Material of construction : Aluminum, mild steel, Plastic.etc.

SN.	Item Description	Qty.
01.	Horizontal profile table work bench	1
02.	Rotary indexing table module	1
03.	Drilling module	1
04.	Pick and Place module	1
05.	Valve manifold assembly	1
06.	Compact ejector assembly	1
07.	IO Interface module	1
08.	FRL Assembly	1
09.	PLC panel assembly - Siemens PLC (S7-1200) with 14 DI / 10 DO, Digital expansion module with 8 DI/ 8DO & Integrated power supplies	1
10.	Control console assembly	1
11.	Acrylic Door assembly with magnetic lock	1
12.	Cable duct and accessories	1
13.	Workbook for process station	1

Sorting Station - 52200E



Technical Specification:

Size (in cm) : 54x64x110
 Installation : Vertical
 Ambient temperature : 60°C Max.
 Medium : Filtered Compressed air
 Operating Pressure range (Bar) : 6-8 bar
 Operating Voltage +/- 10% : 230V AC, 50HZ
 Power consumption : 180 W (224 VA)
 Sensors and actuator operating voltage : 24V, DC
 Material of construction : Aluminum, mild steel, Plastic.etc.

SN.	Item Description	Qty.
01.	Horizontal profile table work bench	1
02.	Conveyor assembly with DC brushless motor	1
03.	Sorting slide assembly	1
03.	Valve manifold assembly	1
04.	IO Interface module	1
05.	FRL Assembly	1
06.	PLC panel assembly - Siemens PLC (S7-1200) with 14 DI/10 DO, DC brushless motor driver unit & Integrated power supply	1
07.	Control console assembly	1
08.	Acrylic Door assembly with magnetic lock	1
09.	Cable duct and accessories	1
10.	Workbook for Sorting station	1

DC Supply

Order Code - 46501



DC Supply is an important device in Electrical laboratories. It is very helpful in performing experiments with DC Voltages. The product provides both Fixed and Variable DC supplies. Product is designed such that it can be connected to any other equipment easily. Additional meters are provided to observe output voltage and current measurements.

Features:

01. Exclusive and rugged designed panel
02. Stand alone operation
03. Designed by considering all the safety precautions
04. High quality meters
05. Provided with an extensive e-manual

Technical Specifications:

Mains Supply : 230 V ±10%, 50Hz

Outputs

Variable DC : 0 -180V

Fixed DC : 180V

Transformer

Rating : 2kVA

Primary Voltage : 0-230V

Secondary Voltage : 0-150V, 0-150V

Meters Used

Voltmeter (MC) : 300V

Ammeter (MC) : 10A

Auto Transformer : 270V, 10A

MCB : 10A

Dimensions (mm.) : W 300 x D 600

DC Supply

Order Code - 46502



AC/DC Load is an important device in all the Electrical laboratories. One can connect a load upto 1.2KW using this product. The device comes with On Board switches, so that one can vary the load as required, in steps of 100W. The product is designed so as to provide load for various experiments of Transformer, Motors, Generators etc.

Features:

01. Exclusive and rugged designed panel
02. Stand alone operation
03. Designed by considering all the safety precautions
04. High quality meters
05. Provided with a extensive e-manual
06. 2 Year warranty

Technical Specifications:

Mains Supply : AC / DC, 230V ±10%

Load Range : 0 - 1.2 kW, in steps of 100W

Load Type : Resistive (Lamp Load)
 Ammeter (MI) : 10A
 Dimensions (mm) : 450 W ´ 600 D ´ 450 H

DC Supply

Order Code - 46503



The "Electrical Safety Demonstrator is a useful trainer for students to understand the basic concepts and fundamentals of many electrical safety standards. Before working with any electrical or electronic device, it is essential to learn about these electrical safety standards. The trainer is helpful to learn, how to avoid accidents, that generally occurring while handling any electric or electronic device. The trainer has been designed for the people who are working in an electrical environment.

Purpose

The purpose of this trainer is to increase student's awareness of :

- * How to use the electricity safely in home and laboratories ?
- * The dangers associated with power lines and sub-stations.
- * The effects of electrocution on the body.
- * Strategies to avoid electrical accidents.

Features:

01. Designed, considering all safety standards.
02. Exclusive design and attractive presentation of each block.
03. This trainer represents many essential safety precautions.
04. Unique demonstration & importance of Earthing.
05. Real time appearance of MCB to help the students to understand its mechanical arrangement.
06. Demonstration of Fuse in very easy way.
07. Provided with a manual containing coloured graphical representation of many safety standards and with very interesting activities which are to be performed by students.

List of Experiment:

01. Performing different electrical activities to avoid electrical hazards.
02. Study of importance of Earthing in any electrical device.
03. Study of role of Fuse in any electrical or electronic circuit.
04. Study of importance and working of Miniature Circuit Breaker (MCB).

Three Phase Lab

Order Code - 46504



The Three Phase Lab with Three Phase Low Voltage Power Supply is an elite training system for the electrical laboratories. There is a three phase low voltage supply that provides 18 V of low voltage which is highly safe. This system is valuable in understanding the basic concepts of Three phase circuits like star-delta connections, their phase and line voltages, currents etc. Being different from the present scenario, this system is designed in such a way that a student can himself make connections of three phase circuits because all the experiments are performed on low voltage. The product is designed with keeping in mind that R, L, C combination can be connected in series as well as in parallel in Three Phase circuits.

Experiments that can be performed:

01. Study of Three phase low voltage power supply
02. Study of Three phase star connection
03. Study of Three phase delta connection
04. Study of Three phase circuits with balanced load
05. Study of Three phase circuits with unbalanced load
06. Three phase power measurement

Technical Specifications:

Three Phase Low Voltage Power Supply (01)
 Input : Three Phase Mains (230 V Phase voltage, 415 Line voltage 50 Hz) $\pm 10\%$
 Outputs : 18V Phase voltage, 28V line voltage 50 Hz $\pm 10\%$
 MCB (Power Switch) : Four Phase Three Phase : (02)
 Input : 18 V each phase, 50 Hz $\pm 10\%$ Loads (03)
 Resistors : 1K, 10K, 47K & 100K
 Capacitors : 0.01 mf, 0.1 mf, 0.22 mf & 0.33mf
 Inductors : 1.2 mH, 10 mH, 40 mH & 100mH

Three Phase Supply Configuration (04)

The Three Phase Supply Configuration module is useful in getting familiar with the Three phase supply configurations. It helps in understanding the working of three phase transformers and their different configurations in star and delta connections.

Experiment: To understand Three phase power supply configurations

Technical Specifications:

Input : 18 V each phase, 50 Hz $\pm 10\%$
 Output : 9V

Three Phase Rectifiers (05)

The Three Phase Rectifiers module is again a versatile module, helpful in understanding the concept of three phase rectifier operation. This module contains silicon diodes for the connections of Half wave and Full wave bridge rectifiers.

Experiment : Study of three phase rectifiers

Technical Specifications:

Input : 18 V each phase, 50 Hz $\pm 10\%$
 Output : 18 V Rectified three phase

Single Phase Transformer Lab (Open, Short, Efficiency & ratio)

Order Code - 46505



Order Code -46505 Single Phase Transformer Lab is an elite training system for the Electrical laboratories. The product helps you to get fully acquainted with the basic concepts and functioning of a Single Phase Transformer. The product is represented in such an easy way so that each test can be studied differently in proper sequence. The Lab practically expertises you in exercises like Polarity, Turns Ratio, Transformation Ratio, Iron Loss, Copper Loss, Efficiency etc. The varied scope of learning makes the subject understanding complete. The setup is complete in all respect and requires no other apparatus. Practical experience on this setup carries a great educative value for Science and Engineering students.

Object:

01. Study of Polarity Test in a Single Phase Transformer
 - Additive Polarity
 - Subtractive Polarity
02. Study of Transformation Ratio in a Single Phase Transformer
 - Isolation Transformer
 - Step Down Transformer
 - Step Up Transformer
03. Study of Open Circuit Test in a Single Phase Transformer
04. Study of Short Circuit Test in a Single Phase Transformer
05. Study of Load Test and correspondingly determine the Efficiency and Voltage Regulation in a Single Phase Transformer

Feature:

- The board consists of the following built-in parts:
01. Two moving iron 72x72 mm AC Voltmeter 0 300 V.
 02. One moving iron 72x72 mm AC Voltmeter 0 50 V.
 03. Two moving iron 72x72 mm AC Ammeter 0 5 Amp.
 04. One moving iron 72x72 mm AC Ammeter 0 1Amp.
 05. Wattmeter single phase, dynamometer type current coil 0.4 Amp. Potential coil 250 Volt 100W
 06. Wattmeter single phase, dynamometer type current coil 4 Amp. Potential coil 250 Volt 1000W
 07. Auto transformer input 230V, output 0270V at 5 Amp.
 08. Transformer:
 - Rating: 1 KVA
 - Primary Voltage: 0 - 125 V, 0 - 125 V
 - Secondary Voltage: 0 - 125 V, 0 - 125 V
 09. MCB: 6Amp
 10. Load: Two 100W Bulb Provided for Load. & three pin Socket for external Load Provided.
- * The unit is operative on 230V $\pm 10\%$ at 50Hz AC Mains.
 - * Set of connecting wires.
 - * Strongly supported by detailed Operating Instructions, giving details of Object, Theory,

Design procedures, Report Suggestions and Book References.

Transformer Trainer (Single / Three Phase)

Order Code - 46505A



TESCA Order Code - 46505A : A Single and Three Phase Transformer Experimental Trainer specially designed to help of students understanding about the various aspects in transformer design and operating such as magnetic fields and circuits, equipments circuits, phase or diagrams, loss components, load testing and regulation, transformer components etc.

A comprehensive experiment manual is provided to guide the students on basic transformer theory and practice and also provides a practical introduction to power supplies and electrical machines.

Object:

01. Polarity Test of Winding
 - Study of polarity test for additive 1.2 Study of polarity test for subtractive
02. Study of series and parallel connection of secondary windings
 - Study of series connection of secondary windings
 - Study of parallel connection of secondary windings 3/4 Magnetic circuits, incorporating the concept of flux, flux density, field strength, magnetomotive force
03. Phasor diagram with transformer on no load
04. Equivalent circuit of power transformer
05. Transformer efficiency and voltage regulation using open and short circuit test
 - Study of open circuit test in a single phase transformer
 - Study of short circuit test in a single phase transformer
 - Measurement of efficiency and voltage regulation at a given load
06. To study the rise in temperature of the winding of the transformer with time
07. Measurement of current using current transformer procedure
08. Study of three phase power supply configurations, delta and star
 - Study of star to star configuration
 - Study of delta to delta configuration
 - Study of star to delta configuration
 - Study of delta to star configuration

Features:

01. Inbuilt single phase Variac.
02. Equipped with supply indication lamp.
03. Facility to use Fixed and Variable Load.
04. Designed by considering all the safety standards.
05. Diagrammatic representation for the ease of connections.
06. Exclusive and compact design.

Technical Specifications:

The board consists of the following built-in parts:

- * Two Digital AC Voltmeter 0 1000 V.
- * Two Digital AC Ammeter 0 2 Amp.
- * Digital Watt meter single phase Potential coil 250 Volt Current coil 2Amp. Total Watt 500W.
- * Temperature Meter.
- * Single Phase Auto Transformer:
 - Primary Voltage : 230V,
 - Secondary voltage : 0-270V
 - Rated current : 2Amp.
- * Single Phase Transformer :
 - Rating : 500W
 - Primary Voltage : 0- 110 V, 0- 110V
 - Secondary Voltage : 0- 110V/1A, 0 - 12V/3A, 24V/1.5A 42V/1A and 110V/1A
- * Three Phase Transformer (Using Three Single Phase Transformer)
 - Secondary voltage : 220V
 - Rated current : 500mA
- * Load : Three Bulb holder Provided for single & Three Phase Load.
- * Current Transformer Ratio 1:10
- * MCB for short circuit and over current 2Amp
- * Power Requirement 380V ±10% at 50Hz AC Mains.
- * Dimensions (mm) : 600 W x 450D x 600 H
- * Weight : 37.5 Kg.

List Of Accessories:

- 01 Shrouded patch cord 4mm length 50 cm Red-10.
- 02 Shrouded patch cord 4mm length 50 cm Black-10.

Other Apparatus Required:

- 01 Resistive Load - Order code - 46610

Transformer Trainer

Order Code - 46505B



46505B Transformer System is a rugged training system for the Electrical laboratories mounted on Aluminum profile rack with sturdy table top flat panel. Each panel has ABS molded plastic sturdy enclosure with 4mm shrouded connectors showing circuit diagram & its connection tag numbers for easy understanding and connections. The product helps you to get fully acquainted with the basic concepts and functioning of a Single/Three Phase Transformer.

Specifications:

- * Machine trainer having control panel should provided in 40X40mm Aluminum profile rack with sturdy table top flat panel .
- * Should have 6 no's of ABS plastic panel mounted on the aluminum rack with mimic diagram
- * All input & output are terminated in 4mm shrouded connector, Should provide 4mm banana cable for experiments.
- * Should have 3phase DOL starter 4pole MCB, contractor & relay panel
 - 4 pole MCB of 415 V/4A .

- DOL 9A Contactor with 230V / 50 Hz / 11VA COIL.
- Bimetallic thermal O/L relay with range 1.4A - 2.3A
- * Should have 3 phase multifunction meter panel (2nos).
 - Bidirectional Multifunction
 - 3 Phase ¾ wire, 415V, CT Input 5A
 - LCD/LED display, Aux supply 230V, 45-65 Hz, 5W V,I., Hz, Pf, KVA, KW, KWH
- * Should have ON/OFF Switch panel.
 - ON/OFF, 4 pole 2 way switch, 6A/440V.
- * Should have Variac panel.
 - 0-200V /2A Variac .
- * Should have Lamp Load panel.
 - 3 Lamp Load socket with 100w Bulb .
- * 1 Phase Transformer 500VA (2Nos)
 - 0-220V Primary input (1x2 socket)
 - 0-110V Secondary output (2x2 socket) .
- * 3 Phase Transformer 500VA.
 - 0-415V Primary input (3x2 socket)
 - 0-415V Secondary output (3x2 socket) .

Experiment List:

01. Finding Transformer equivalent circuit.
02. Study of transformer regulation.
03. Measurement of winding temperature.
04. Effect of type of load on transformer output waveform.
05. Three phase transformer connections.
06. Scott connection : Using 2 Nos. of 1phase transformer 3ph. to 2ph. conversion.
07. Parallel Operation on 1 Phase transformer.
08. Effect of variety of three phase connections on regulation and current carrying capacity of transformers.
09. Harmonic cancellation & shift in phasor diagram due to different connections, Working of Teaser transformer
10. Back to back test (sumpner test) on two identical single phase transformers.

Power Measurement by Two Wattmeter Method

Order Code - 46506



Power Measurement by Two Wattmeter Method is an exclusive & useful product designed for Electrical laboratories to explain the students, how total power is measured in a three phase circuit using only two wattmeters. With this product, student can study the power flow in three phase system and correspondingly calculate Active, Reactive and Apparent power. Apart from this student can easily understand different three phase parameters like Star connection, Delta connection, Line Voltage, Line Current, Phase Voltage, Phase Current and their mutual relationships.

Features:

01. Exclusive and rugged designed panel
02. Designed by considering all the safety precautions
03. Stand alone operation
04. High quality meters

05. Diagrammatic representation for the ease of connections
06. Provided with an extensive e-manual

Technical Specifications:

Mains Supply : Three Phase 415 V ±10 %, 50 Hz
 Load : R - L

Meters Used

Wattmeters : 500 W (2 Nos.)
 Voltmeter (MI) : 500 V
 Ammeter (MI) : 1 A
 MCB : 10 A
 Dimensions (mm.) : 350 W ´ 600 D ´ 450 H

List of Experiments:

01. Measurement of Power Factor in a Three Phase Circuit
02. Measurement of Active, Reactive and Apparent Power in a Three Phase Circuit
03. Measurement of Three Phase Parameters

Wattmeter Method

Order Code - 46507



Three Phase Induction Motor Trainer is an adaptable training system for the Electrical laboratories. The product helps you to get fully acquainted with the basic concepts and functioning of a Three Phase squirrel cage Induction Motor. The trainer practically expertises you in exercises like Running and Reversing, No Load Test, Block Rotor Test, Slip Measurement, Load Test etc. The vast scope of learning makes the subject completely understandable.

Features:

01. Machine with Mechanical Loading Arrangement
02. Provided with Digital Tachometer
03. Machine with Class "B" Insulation
04. Heavy Duty Base/Channel
05. Brake-Drum/Pulley with heat suppression facility
06. Equipped with supply indication lamps
07. Designed by considering all the safety standards
08. Diagrammatic representation for the ease of connections
09. Exclusive and Compact Design
10. Learning material CD
11. 2 Year Warranty

Scope of Learning

01. Study of Running and Reversing of Three Phase Induction Motor
02. Study of No Load Test performed in a Three Phase Induction Motor
03. Study of Block Rotor Test performed in a Three Phase Induction Motor
04. Measurement of Slip in a Three Phase Induction Motor
05. Study of Speed-Torque characteristics in a Three Phase Induction Motor

Technical Specifications:

Mains Supply : Three Phase, 415V ±10%, 50Hz

Three Phase Induction Motor

Type : Squirrel Cage
 Rating : 1HP (Also available with 2 HP, 3 HP and 5 HP)
 Voltage Rating : 415V
 Speed : 1440 RPM (No Load)
 Insulation : Class 'B'
 Loading arrangement : Mechanical
 Brake Drum/Pulley : Aluminum Casted
 Analog Meters used
 Wattmeter : 1000W (2 Nos.)
 Voltmeter (MI) : 500V
 Ammeter (MI) : 5A
 MCB (TPN) : 10A
 Tachometer : 20,000 RPM
 Dimensions (mm) : W 600 x D 350 x H 450 (Control Panel)
 W 250 x D 400 x H 600 (Motor)
 Weight : 14.5kg (approximate) (Control Panel)
 22kg (approximate) (Motor)

Optional

01. Three Phase Variac, 10A

DC Machine Lab-I

Order Code - 46508



DC Machine Lab-I is an adaptable training system for the Electrical laboratories. It can be aptly employed for understanding the basic concepts and functioning of DC Motors and Generators. The product provides hands-on experiments like Speed control, Torque- Load Characteristics, N-V Characteristics, N-I Characteristics etc. The trainer thus provides explicit understanding of the subject.

Features:

01. DC Shunt Machines
02. Electrical Loading arrangement upto 1.2KW
03. Shaft Coupling arrangement
04. Exclusive and rugged designed panel
05. Stand alone operation
06. Designed by considering all the safety precautions
07. High quality meters
08. Diagrammatic representation for the ease of connections
09. Provided with an extensive e-manual
10. 2 Year warranty

Technical Specification:

Input (Optional 46501) : 180 V Fixed DC
 0-180 V Variable DC

DC Machines

Type : DC Shunt
 Rating : ½ HP
 RPM : 1400 (No Load)

Meters used

Voltmeter (MC) : 300 V (2 Nos.)

Ammeter (MC) : 2 A (2 Nos.)
 Ammeter (MC) : 5 A (2 Nos.)
 Dimensions (mm.) : 450 W 600 D 600 H (Panel)
 250 W 800 D 300 H (MG Set)

List of Experiments:

01. Study of No Load Characteristics (OCC) of DC Shunt Generator
02. Study of Load Characteristics of DC Shunt Generator
03. Speed Control of DC Shunt Motor by Field and Armature current variation
04. Load Characteristics of DC Shunt Motor
05. Study of self excited DC Shunt Motor

DC Machine Lab II

Order Code - 46509



DC Machine Lab-II is an important system for the Electrical laboratories. It is DC Machine Lab-II that provides comprehensive learning of functioning of a DC Motor. It can aptly be employed for performing various exercises like Motor Starting, Speed Control, N-I Characteristics etc. Thus the trainer makes the subject understanding complete.

Features:

01. DC Shunt Motor
02. Mechanical Loading arrangement
03. Exclusive and rugged designed panel
04. Stand alone operation
05. Designed by considering all the safety precautions
06. High quality meters
07. Diagrammatic representation for the ease of connections
08. Provided with an extensive e-manual
09. 2 Years warranty

Technical Specifications:

Input (Optional 46501) : 180 V Fixed DC
 0-180 V Variable DC

DC Machine

Type : DC Shunt
 Rating : ½ HP
 RPM : 1400 (No Load)

Meters used

Voltmeter (MC) : 300 V
 Ammeter (MC) : 1 A
 Ammeter (MC) : 5 A
 Dimensions (mm.) : 350W x 600D x 450H Panel
 : 250W x 400D x 600H Motor

List of Experiments:

- Speed Control of DC Shunt Motor by Field and Armature current variation.
01. Load Characteristics of DC Shunt Motor.
 02. N-I Characteristics of DC Shunt Motor.
 03. N-V Characteristics of DC Shunt Motor.
 04. Study of self excited DC Shunt Motor.

Scott Connection Trainer

Order Code - 46510



Scott Connection Trainer is an vital training system for the Electrical Laboratories. It provides comprehensive learning of Three Phase to Two Phase Conversion in a very simple manner. Study and Analyze the operation of Teaser Transformer and Main Transformer. Students can perform standalone operation and observe the two phase step down waveforms on oscilloscope, which will have 90° phase displacement with each other. The training system is engineered to be simple.

Features:

01. Stand alone operation
02. Exclusive and attractive designed panel
03. Designed by considering all the safety precautions
04. Main and Teaser Transformers are shown separately
05. On board high quality meters
06. Two phase step down outputs available for waveforms observation on oscilloscope
07. Provided with an extensive e-manual
08. Two years warranty

Technical Specifications :

Input : 415 VAC ±10%, 50 Hz

Main Transformer

Input Winding : 0 - 200 V (50%) ±10%, 50 Hz

: 0 - 200 V (50%) ±10%, 50 Hz

Output Winding : 0 - 230 V ±10%, 50 Hz

Teaser Transformer

Input Winding : 0 - 115.6 V (28.9%) ±10%, 50 Hz

: 346.4 V (86.6%) ±10%, 50 Hz

: 400 V ±10%, 50 Hz

Output Winding : 0 - 230 V ±10%, 50 Hz

Step down Transformers (2Nos.)

Input Winding : 0 - 230 V ±10%, 50Hz

Output Winding : 0 - 18 V ±10%, 50Hz

Meters Used

Voltmeter (MI) : 500 V (2 Nos.)

Ammeter (MI) : 1 A (2 Nos.)

Dimensions (mm) : W 600 x D 350

List of Experiments:

01. Study of Teaser Transformer
02. Study of Scott Connection (Three Phase to Two Phase Conversion)

Sumpner's Test of Two Single Phase Transformers

Order Code - 46511



Sumpner's Test of Two Single Phase Transformers is a very exclusive and important product designed for

students of Electrical Engineering to explain the basic concepts of Sumpner's test. With this trainer, students can learn about the significance of conducting the heat run test with two single phase transformers and correspondingly can determine the efficiency and voltage regulation. Additionally one can also learn the phenomenon of polarity.

The product helps to get fully acquainted with the basic concepts and functioning of the tests conducted on a single phase transformers. The product is represented in such an easy way so that each test can be studied in proper sequence. The varied scope of learning makes the subject complete understanding and interesting.

Features:

01. Stand alone operation
02. Exclusive and attractive designed panel
03. Designed by considering all the safety precautions
04. On board high quality meters are used
05. Microcontroller based LCD used to display raising temperature
06. Provided with an extensive e-manual
07. Two years warranty

Technical Specifications:

Mains Supply : 230V ±10%, 50Hz

Transformers

Rating : 1 kVA

Primary Voltage : 0 - 125 V, 0 - 125 V

Secondary Voltage : 0 - 125 V, 0 - 125 V

Meters Used

Voltmeter (MI) (2Nos.) : 100 V, 300 V

Ammeter (MI) (2Nos.) : 1 A, 10 A

Wattmeter (MI) (2Nos.) : 100 W, 1000 W

Auto Transformer : 270 V, 10 A

MCB : 10 A

Dimensions (mm) : W 600 x D 450 x H 600

List of Experiment:

01. Study of Polarity Test with Two Single Phase Transformers
02. Study of Sumpner's Test-
Open Circuit Test
Short Circuit Test and
Determination of the Efficiency and Voltage Regulation of Two Single Phase Transformers.

Parallel Operation of Two Single Phase Transformers

Order Code - 46512



Parallel Operation of Two Single Phase Transformers has been exclusively designed to demonstrate the fundamental concepts of parallel connections of two or more single phase transformers. You can load on the transformer more than the rating of the individual transformer then analyze the Parallel operation phenomenon. Students can learn about the significance of connecting the two transformers in parallel and its effect on the system. Additionally one can also learn the polarity in the transformers.

The training system helps to get fully acquainted with the functioning of a single phase transformer. The varied scope of learning makes the subject completely understanding and interesting.

Features:

01. Exclusive and attractive designed panel
02. Stand alone operation
03. Designed by considering all the safety precautions
04. Diagrammatic representation for the ease of connections
05. On board high quality meters
06. Provided with an extensive e-manual

Technical Specifications :

Mains supply : 230 VAC ±10%, 50Hz

Transformers (2Nos.)

Rating : 1kVA
 Primary Voltage : 0 - 230 V
 Secondary Voltage : 0 - 200 - 230 V

Meters Used

Voltmeter (MI) : 500 V (2 Nos.)
 Ammeter (MI) : 10 A (2 Nos.)
 MCB (Single Phase) : 10 A
 Dimensions (mm.) : W 600 x D 350 x H 450

List of Experiments:

01. Study of polarity test under two single phase transformers
02. Study of parallel operation of two single phase transformers under equal voltage ratio
03. Study of parallel operation of two single phase transformers under unequal voltage ratio.

DC Series Machine Lab

Order Code - 46513



DC Series Motor Lab is a very useful product for any electrical Laboratory to demonstrate the fundamental concepts and operating principles of DC machines. It is useful for students to enhance their practical knowledge which enables complete learning.

Demonstrates, operating characteristic of DC Series Motor. Students can get aware of the methods through which the speed of the DC Series Motor can be controlled. It includes terminals for Rheostat and Starters so that these devices can be connected externally to the panel.

All connections and panel ergonomics are designed in such a manner that students can make connections by themselves. All protection devices are in built eliminating chances of fault or danger to user.

Features:

01. Stand alone operation
02. Exclusive and attractive designed panel
03. High quality meters
04. Designed by considering all the safety precautions
05. Safety terminals and patch chord package.

07. E-Manual

Technical Specifications:

Input : 0 - 180 V Variable DC

Machine Specifications

Type : DC Series
 Voltage rating : 180 V
 Current rating : 3 A
 Power Rating : 1 HP
 RPM : 1500 R.P.M

Meters used

Voltmeter (MC) 1 No. : 300 V
 Ammeter (MC) 2 Nos. : 5 A
 Dimensions (mm) : W 350 × D 600 × H 450

List of Experiments:

01. Study of Operating Characteristics of Separately Excited DC Series Motor
02. Study of Speed Control of Separately Excited DC Series Motor using Field Current Control
03. Study of Speed Control of Separately Excited DC Series Motor using Armature Voltage Control

Single Phase Induction Motor Lab

Order Code - 46514



Single Phase Induction Motor Lab is an exclusive and attractive training system for the electrical laboratories. It provides complete learning concepts of Single Phase Capacitor Start Induction Motor. Separate terminals have been provided for main winding, starting winding and capacitor so that student can understand the significance of individual windings along with the role of capacitor in the motor in a simple manner.

It includes phenomenon of excitation, running and reversing of the motor. Students can calculate the equivalent circuit parameters and the power factor of the motor. It demonstrates the relation between speed and torque, known as load characteristic or speed-torque characteristic of the motor.

All connections and appearance of panel are designed in a simple manner. Students can make connections by themselves.

Features:

01. Exclusive and attractive designed panel
02. Stand alone operation
03. Designed by considering all the safety standards
04. High quality meters
05. Diagrammatic representation of the circuit for ease of connections
06. E-Manual

Technical Specifications:

Mains Supply : 230 V ±10%, 50 Hz

Induction Motor

Type : Capacitor start
 Phase : Single
 Current type : AC
 Rating : 1 HP
 Voltage rating : 230 V ± 10%

Meters Used

Voltmeter : 0-300 V
 Ammeter : 0-10 A

Wattmeter : 1000 W
 MCB : 10 A

List of Experiments:

01. Study of Single Phase Induction Motor
02. Study of Running and Reversing of Single Phase Induction Motor
03. Study of the No-Load Test in a Single Phase Induction Motor
04. Study of the Blocked Rotor Test in a Single Phase Induction Motor
05. Study of Load Test of a Single Phase Induction Motor

Single Phase Energy Meter Trainer

Order Code - 46515



Single Phase Energy Meter Trainer describes a high accuracy, low cost, single-phase energy meter. The meter is designed for use in single-phase, 2-wire distribution systems. The design can be adapted to suit specific regional requirements, e.g., in USA, power is usually distributed for residential customers as singlephase, 3-wire.

This is a highly integrated system comprised of two ADC's, a reference circuit, and a fixed DSP function for the calculation of real power. A highly stable oscillator is integrated into the design to provide the necessary clock for the IC. This includes direct drive capability for LCD Display and a high frequency pulse output for Calibration.

Features:

01. Complete training system for in depth study of Single Phase Energy Meter.
02. Micro controller based LCD display.
03. The display acts as a counter of units consumed as well as it shows the wattage of load and the time since the system has been On.
04. Easy diagrammatic representation of Energy Meter.
05. Test points are provided to measure the voltages at different points.
06. Low Cost Trainer with high accuracy, demonstrating all the basic concepts of Single Phase Energy Measurement.
07. Good quality, reliable sockets are provided at appropriate places on board for electric board supply and load connections.
08. Designed with considering all safety standards.
09. Provided with an extensive e-manual.

Technical Specifications:

Line Voltage : 230V AC \pm 10%, 50 Hz
 Meter Constant : 1600 impulses/KWh (On LED)
 Display Counter : 100 impulses /KWh (On LCD)
 Maximum Current : 30 A
 Shunt : 350 mW

List of Experiments:

01. Study the application of Single Phase Energy Meter for measurement of Power Consumed.

02. Study of Single Phase Energy Meter using different test points and to understand its working

Study of UJT and UJT Relaxation Oscillator

Order Code - 46518



Power Electronic Training Board has been designed specifically for the study of Electrical Characteristics of Uni- Junction Transistor. The UJTs are widely used for Relaxation Oscillator, waveform & pulse generators and firing circuits of SCR's and TRIAC's. This Training Board can also make use for designing firing circuits and control circuits for thyristors.

Practical experience on this board carries great educative value for Science and Engineering Students.

Object:

01. Study of Zener Diode as Voltage Regulator
02. Study of Static Emitter Characteristics of UJT-Unijunction Transistor on oscilloscope.
03. Study of effect of V on peak point and valley point voltage and valley point current. BB
04. Operation of UJT Relaxation Oscillator and its use as SCR trigger circuit.
05. Control of UJT trigger Pulses with shunt transistor.
06. Study of Variations in gate resistance & capacitance, resistance of source & drain and their effect on trigger pulse characteristics of UJT relaxation oscillator.
07. Various Configurations of UJT relaxation oscillator type 1 (low output impedance), type 2 (moderate output impedance) and type 3 (high output impedance).

Features:

The board consists of following built-in parts:

01. An isolation transformer 230V A.C. at 100mA. This protects external instruments from damage if they are not isolated.
02. 20V D.C. at 100mA, IC Regulated Power Supply internally connected.
03. Bridge rectifier and zener regulator.
04. Potentiometer for frequency control.
05. Two band switches for selecting different value of resistance and capacitance.
06. Pulse transformer 1:1:1.
07. UJT 2N 2646 under experiment.
08. Adequate no. of other Electronic Components.
09. Mains ON/OFF switch, Fuse and Jewel light.
- * The unit is operative on 230V \pm 10% at 50Hz A.C. Mains.
- * Adequate no. of patch cords stackable 4 mm spring loaded plug length 1/2 metre.
- * Good Quality, reliable terminal/sockets are provided at appropriate places on panel for connections/observation of waveforms.
- * Strongly supported by detailed Operating Instructions, giving details of Object, Theory, Design procedures, Report Suggestions and Book References.

Other Apparatus Required:

01. Digital Multimeter 3 3/4 digit - Order Code 16901

02. 0-30V, 1Amp IC Regulated Power Supply
03. Dual Trace Cathode Ray Oscilloscope 20 MHz (Unearthed)
04. Variac, 0-230VA.C. @ 2Amp

Study of SCR and A.C. Phase Control

Order Code - 46519



Power Electronic Training Board has been designed specifically to study A.C. Phase Control circuits by using different triggering schemes. SCRs are becoming an essential component for power control. Practical experience on this board carries great educative value for Science and Engineering Students.

Object:

To perform the following experiments :

01. Resistance trigger circuit for SCR to be operated as half-wave static switch and limited range half wave phase control.
02. R.C. trigger circuit for SCR operated as full range half-wave phase control.
03. R.C. trigger circuit for SCR connected in bridge full range full-wave phase control.
04. Half -wave phase control with SCR using UJT trigger circuit-resistance controlled ramp.
05. Full-wave phase control with Inverse Parallel SCRs using UJT trigger circuit-resistance controlled ramp.
06. Full-wave phase control with half controlled bridge converter using UJT trigger circuit-resistance controlled ramp.
07. UJT trigger circuit with series transistor control ramp.
08. UJT trigger circuit using shunt transistor controlled pedestal.
09. UJT trigger circuit-resistance controlled pedestal with improved ramp.
10. UJT trigger circuit - resistance controlled pedestal with cosine-modified ramp.

Features:

The board consists of following built-in parts:

01. An isolation transformer 230VA.C. 250mA. This protects external instruments from damage if they are not isolated.
02. Bridge rectifier for full-wave phase control with zener regulator.
03. Two potentiometers for resistance controlled ramps.
04. Two potentiometers for resistance controlled pedestals.
05. Uni-Junction Transistor 2N 2646.
06. Pulse transformer 1:1:1.
07. Three SCRs for half-wave and full-wave inverse parallel connections.
08. Adequate no. of other Electronic Components
09. Mains ON/OFF switch, Fuse and Jewel light.
- * The unit is operative on 230V \pm 10% at 50Hz A.C. Mains.
- * Adequate no. of patch cords stackable 4 mm spring loaded plug length $\frac{1}{2}$ metre.
- * Good Quality, reliable terminal/sockets are

provided at appropriate places on panel for connections/observation of waveforms.

- * Strongly supported by detailed Operating Instructions, giving details of Object, Theory, Design procedures, Report Suggestions and Book References.

Other Apparatus Required:

01. Digital Multimeter 3 $\frac{3}{4}$ digit - Order Code 16901
02. 0-30V, 1 Amp IC Regulated Power Supply

DV/ DT Limitation of SCR's

Order Code - 46520



Power Electronic Training Board has been designed specifically to study the Dv/Dt characteristics of SCR. It is essential to improve the Dv/Dt capability of SCRs to avoid false firing which may be disastrous in some applications. Different schemes given on the board, help the students to design and study various snubber circuits to improve the Dv/Dt capability of thyristors. Practical experience on this board carries great educative value for Science and Engineering Students.

Object:

To perform the following experiments :

01. Test dv/dt estimation of the SCR.
02. Compare Dv/Dt capability by Gate-Cathode terminations.
03. Compare Dv/Dt capability by Gate-Cathode biasing (Voltage biasing).
04. Compare Dv/Dt capability by Gate-Cathode biasing (Current biasing).
05. To improve Dv/Dt capability by transistor snubber circuit.
06. Effect of R.C. Snubber circuit on Dv/Dt capability.
07. Study of different Scheme of R.C. Snubber circuit on Dv/Dt capability.

Features:

The board consists of following built-in parts:

01. 300V D.C. at 250 mA, Power Supply internally connected.
02. Thyristor switch for applying sudden voltage on the SCR under experiment.
03. The SCR under experiment.
04. Resistance for gate-cathode termination.
05. Silicon diode.
06. Transistorized snubber circuit.
07. Two schemes for R-C snubber circuits.
08. Visual indication to indicate SCR firing.
09. Adequate no. of other Electronic Components.
10. Mains ON/OFF switch, Fuse and Jewel light.
- * The unit is operative on 230V \pm 10% at 50Hz A.C. Mains.
- * Adequate no. of patch cords stackable 4 mm spring loaded plug length $\frac{1}{2}$ metre.
- * Good Quality, reliable terminal/sockets are provided at appropriate places on panel for connections/ observation of waveforms.
- * Strongly supported by detailed Operating Instructions, giving details of Object, Theory, Design procedures, Report Suggestions and Book

References.



Other Apparatus Required:

01. Digital Multimeter 3¾ digit - Order Code 16901
02. 0-30V, 1Amp IC Regulated Power Supply

Study of Triac and A.C. Phase Control

Order Code - 46521



Power Electronic Training Board has been designed specifically to study the characteristics of a TRIAC and its application as A.C. Power Control using phase control technique. The unit is provided with built-in load facility. Experiments for the study of radio frequency interference in phase control and methods of their suppression, can be conducted on this training board. Practical experience on this board carries great educative value for Science and Engineering Students.

Object:

To perform the following experiments :

01. Study of TRIAC characteristics and its operation in all the four modes i.e. I+, I-, III+ and III-.
02. Gate control of TRIAC with NPN transistor.
03. Gate control of TRIAC with PNP transistor.
04. Phase control with TRIAC and DIAC as pulse generator for gate trigger.
05. Light dimmer with TRIAC-hysteresis effect and its minimization by gate slaving technique.
06. Study the Radio Frequency Interference (RFI) in phase control and its suppression by RFI filter.

Features:

The board consists of following built-in parts:

01. TRIAC.
02. DIAC.
03. Two potentiometers for biasing and phase control.
04. RF choke and capacitor for RFI filter.
05. Lamp holder with 40 Watt lamp for load in power control indicator.
06. Adequate no. of other Electronic Components.
07. Mains ON/OFF switch, Fuse and Jewel light.
- * The unit is operative on 230V ±10% at 50Hz A.C. Mains.
- * Adequate no. of patch cords stackable 4 mm spring loaded plug length ½ metre.
- * Good Quality, reliable terminal/sockets are provided at appropriate places on panel for connections/observation of waveforms.
- * Strongly supported by detailed Operating Instructions, giving details of Object, Theory, Design procedures, Report Suggestions and Book References.

Other Apparatus Required:

01. Digital Multimeter 3¾ digit - Order Code 16901
02. 0-30V, 1 Amp IC Regulated Power Supply
03. Dual Trace Cathode Ray Oscilloscope 20MHz (Unearthed)

SCR Converters and Reactive Loads

Order Code - 46522

Power Electronic Training Board has been designed specifically to study the SCR conduction in different circuit configurations and under various forms of load. The load can be selected from resistive, inductive, capacitive or combinations of any of them. The SCR converter can also be used as source for other experiments.

Practical experience on this board carries great educative value for Science and Engineering Students.

Object:

01. Study of SCRs triggering in half controlled bridge under reactive loads-limitations of simple UJT triggering circuits.
02. Study of SCR triggering in half controlled bridge under reactive loads using auxiliary SCR triggering circuit with extended pulse technique.
03. Study of half controlled bridge and action of free wheeling diode.
04. Study of fully controlled full wave 4-SCR bridge operation under converter mode.

Features:

The board consists of following built-in parts:

01. UJT relaxation oscillator and triggering pulse generator with resistance ramp control.
02. Three numbers of pulse transformers each 1:1:1 type.
03. Mains transformer having outputs 0-12V at 100 mA, 0-12V at 100 mA & 0-32V at 500 mA.
04. Two SCRs connected in pulse amplifier and extender configuration and used as auxiliary SCR for triggering main SCRs under reactive load.
05. Two SCRs and two diodes connected in half-controlled bridge configuration.
06. Four SCRs connected in full wave bridge configuration.
07. Resistive, Inductive and Capacitive load which can be used individually or in combinations.
08. Mains ON/OFF switch, Fuse and Jewel light.
- * The unit is operative on 230V ±10% at 50Hz A.C. Mains.
- * Adequate no. of patch cords stackable 4 mm spring loaded plug length ½ metre.
- * Good Quality, reliable terminal/sockets are provided at appropriate places on panel for connections/observation of waveforms.
- * Strongly supported by detailed Operating Instructions, giving details of Object, Theory, Design procedures, Report Suggestions and Book References.

Other Apparatus Required:

01. Digital Multimeter 3¾ digit - Order Code 16901
02. Dual Trace Cathode Ray Oscilloscope 20MHz (Unearthed)

SCR Regulated D.C. Power Supply

Order Code - 46523



Power Electronic Training Board has been designed specifically for the study of continuously variable SCR Regulated Power Supply. The power supply can be manipulated to operate under different circuit conditions in order to provide insight into the important modes of SCR power supply operation. The output voltage can be varied from 10 to 40 Volts continuously. The power supply can also be used as a stabilised source to feed external load up to 500mA. Internal loads are provided to test the performance in 16 steps. Practical experience on this board carries great educative value for Science and Engineering Students.

Object:

01. Study of output voltage variation, regulation and ripple in open loop (without feed back) by varying the load using inductance input filter.
02. Same as above experiment by using capacitor input filter.
03. Study of output voltage variation, regulation and ripple in closed loop feed back by varying the load using inductance input filtershunt transistor pedestal control.
04. Same as above experiment by using capacitor input filter-shunt transistor pedestal control.
05. Study of variation in output voltage for different slopes of linear resistance controlled ramp.
06. Study of line voltage variation (open loop) compensation.
07. Study of output voltage variation, regulation and ripple in closed loop feed back by varying load-series transistor controlled ramp in differential amplifier mode.

Features:

The board consists of following built-in parts:

01. 24V D.C. Regulated Power Supply internally connected.
02. Free wheeling diode.
03. Transformer 0-40V, 500 mA.
04. Two SCRs connected in bridge configuration with rectifiers.
05. Four diode connected in bridge and one zener for control circuit supply.
06. UJT 2N 2646 for relaxation oscillator to supply triggering pulses for SCRs.
07. Pulse transformer 1:1:1.
08. Three potentiometers for different modes of voltage adjustment.
09. Adequate no. of other Electronic Components.
10. Mains ON/OFF switch, Fuse and Jewel light.
- * The unit is operative on 230V ±10% at 50Hz A.C. Mains.
- * Adequate no. of patch cords stackable 4 mm spring loaded plug length ½ metre.
- * Good Quality, reliable terminal/sockets are provided at appropriate places on panel for connections/observation of waveforms.
- * Strongly supported by detailed Operating Instructions, giving details of Object, Theory, Design procedures, Report Suggestions and Book References.

Other Apparatus Required:

01. Digital Multimeter 3¾ digit - Order Code 16901
02. Dual Trace Cathode Ray Oscilloscope 20MHz (Unearthed)
03. Variac, 0-230VA.C. @ 2Amp

Triac A.C. Line Switching

Order Code - 46524



Power Electronic Training Board has been designed specifically to study various switching techniques of TRIAC - a bidirectional silicon controlled switch. The phase control applications of TRIAC are included in another board order Code 46521.

Practical experience on this board carries great educative value for Science and Engineering Students.

Object:

01. Study of TRIAC as line triggered A.C. power switch.
02. Study of TRIAC as D.C. triggered A.C. power switch.
03. Study of TRIAC as self latching line switch.
04. Study of TRIAC as UJT triggered A.C. power switch.
05. Study of TRIAC as UJT triggered A.C. power switch with external transistor control from transducer.

Features:

The board consists of the following built in parts:

01. An isolation transformer 230VA.C. 250mA. This protects external instruments from damage if they are not isolated.
02. 12V D.C. at 250 mA, IC Regulated Power Supply for D.C. Triggering.
03. The TRIAC under experiment.
04. Two push button switches for triggering.
05. UJT 2N 2646 connected in relaxation oscillator mode to provide triggering pulses.
06. Pulse transformer 1:1.
07. NPN Transistor for UJT control with external transducer.
08. Lamp holder with 40 Watt lamp for load in power control indicator.
09. Adequate no. of other Electronic Components.
10. Mains ON/OFF switch, Fuse and Jewel light.
- * The unit is operative on 230V ±10% at 50Hz A.C. Mains.
- * Adequate no. of patch cords stackable 4 mm spring loaded plug length ½ metre.
- * Good Quality, reliable terminal/sockets are provided at appropriate places on panel for connections/observation of waveforms.
- * Strongly supported by detailed Operating Instructions, giving details of Object, Theory, Design procedures, Report Suggestions and Book References.

Other Apparatus Required:

01. Digital Multimeter 3¾ digit - Order Code 16901
02. Dual Trace Cathode Ray Oscilloscope 20MHz (Unearthed)

Thyristor Time Delay Relay

Order Code - 46525



Power Electronic Training Board has been designed specifically to study the operation of SCR and TRIAC triggered by electronic time delay circuit. This facilitates to perform the experiment to students both the modes of operation-delayed turn on and auto turn off to control any type of load i.e. A.C. or D.C. Practical experience on this board carries great educative value for Science and Engineering Students.

Object:

01. Study of delayed Turn-ON of D.C. load.
02. Study of auto Turn-OFF of D.C. load.
03. Study of delayed Turn-ON of TRIAC as line switch.
04. Study of auto Turn-OFF of TRIAC as line switch.

Features:

The board consists of the following built in parts:

01. 12V D.C. at 2 Amp, Power Supply internally connected.
02. UJT 2N 2646 used as timer.
03. Potentiometer for ramp control to adjust time delay.
04. Set of 3 Capacitors for time delay control.
05. Two SCRs connected in parallel coupled mode.
06. Commutation capacitor.
07. Push button switch for starting.
08. TRIAC for A.C. line switch.
09. Lamp holder with 15 watt 230V lamp for A.C. load.
10. Adequate no. of other Electronic Components.
- * The unit is operative on 230V ±10% at 50Hz A.C. Mains.
- * Adequate no. of patch cords stackable 4 mm spring loaded plug length ½ metre.
- * Good Quality, reliable terminal/sockets are provided at appropriate places on panel for connections/observation of waveforms.
- * Strongly supported by detailed Operating Instructions, giving details of Object, Theory, Design procedures, Report Suggestions and Book References.

Other Apparatus Required

01. Digital Multimeter 3¾ digit - Order Code 16901
02. Digital Stop Clock

Thyristor Alarms

Order Code - 46526



Power Electronic Training Board has been designed specifically to study the applications of SCRs in electronic alarm circuits. The high power gain, low leakage currents and high current carrying capacity of SCRs make them ideal for such applications. This training board is an important set up to study various configurations and designs of electronic alarm circuits. The board is absolutely self contained and requires no other apparatus.

Practical experience on this board carries great educative value for Science and Engineering Students.

Object:

01. Study of Make-to-operate alarms.
02. Study of Break- to-operate alarms.

03. Demonstration of temper-proof burgler alarm.
04. Demonstration of alarm with delayed self latching.
05. Demonstration of alarm operated with water level.
06. Demonstration of alarm sensitive to light beam using L.D.R.
07. Demonstration of alarm sensitive to temperature using thermistor.

Features:

The board consists of following built-in parts:

01. 12V D.C. Power Supply internally connected.
02. Internal 12V audio alarm.
03. Push button switch for push to break demonstration.
04. Push button switch for push to make demonstration.
05. One PNP and two NPN transistors for electronic alarm control.
06. Two PNP transistors connected in differential amplifier mode for light and temperature sensing.
07. SCR for alarm operation.
08. Potentiometer for time delay control.
09. Potentiometer for balance of differential amplifier.
10. ON/OFF switch for 12V D.C. stand by and reset.
11. LDR for light sensing and thermistor for temperature sensing.
12. Fuse protection for 12V D.C. supply.
13. Adequate no. of other Electronic Components.
14. Mains ON/OFF switch, Fuse and Jewel light.
- * The unit is operative on 230V ±10% at 50Hz A.C. Mains.
- * Adequate no. of patch cords stackable 4 mm spring loaded plug length ½ metre.
- * Good Quality, reliable terminal/sockets are provided at appropriate places on panel for connections/observation of waveforms.
- * Strongly supported by detailed Operating Instructions, giving details of Object, Theory, Design procedures, Report Suggestions and Book References.

SCR Ring Counter

Order Code - 46527

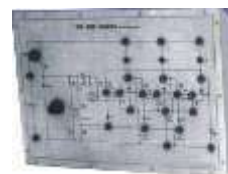

Power Electronic Training Board has been designed specifically to study three stage SCR Ring Counter which can be extended to any number of stages by adding identical circuitry, if required. This board demonstrates high power load switching in a sequential order. This set-up can also be used as sequential flash over. The time delay between each sequence is adjustable. This training board facilitates students to understand UJT triggering circuit for SCRs and communication circuit for turning them off in sequential operations.

Practical experience on this board carries great educative value for Science and Engineering Students.

Object:

01. To study operation of Ring Counter with internal load.
02. To study operation of Ring Counter with external load.

Features:

The board consists of the following built in parts:

01. 20V D.C. Zener Regulated Power Supply for control pulse generator.
 02. UJT 2N 2646 in relaxation oscillator configuration which provides triggering pulses to SCRs.
 03. Potentiometer for variable time delay.
 04. Three SCRs to form three stages of ring counter.
 05. Three diodes for providing triggering pulses.
 06. Three dual indicating lamps for indication of sequences.
 07. UJT 2N 2646 under experiment.
 08. Adequate no. of other Electronic Components.
 09. Fuse for protection.
- * The unit is operative on 220V D.C. Source.
 - * Adequate no. of patch cords stackable 4 mm spring loaded plug length ½ metre.
 - * Good Quality, reliable terminal/sockets are provided at appropriate places on panel for connections/observation of waveforms.
 - * Strongly supported by detailed Operating Instructions, giving details of Object, Theory, Design procedures, Report Suggestions and Book References.

Other Apparatus Required:

01. 220V D.C. at 100mA IC Regulated Power Supply

SCR Triggering Circuit Using IC TCA-785

Order Code - 46528



Power Electronic Training Board has been designed specifically for the study of SCR Triggering using IC TCA-785. This Training Board gives a better understanding on the operation of Signal Conditioner and Pulse Generator IC TCA-785. Practical experience on this board carries great educative value for Science and Engineering Students.

Object:

To perform the following experiments :

01. SCR triggering with controlled gate pulses.
02. Change of firing angle in response to the change in reference voltage
03. Functioning of Signal Conditioner and Pulse Generator IC TCA-785.

Features:

The board consists of the following built in parts:

01. + 15V, +10V D.C. at 50mA, IC Regulated Power Supply internally connected.
 02. + 5V D.C. at 50mA, IC Regulated Power Supply Isolated.
 03. Synchronising Signal.
 04. 24V at 300mA A.C. supply.
 05. Signal Conditioner and Pulse Generator IC TCA-785.
 06. Op to Coupler.
 07. SCR 100V/1Amp.
 08. Transistor BC-107.
 09. Adequate no. of other Electronic Components.
 10. Mains ON/OFF switch, Fuse and Jewel light.
- * The unit is operative on 230V ±10% at 50Hz A.C. Mains.

- * Adequate no. of patch cords stackable 4 mm spring loaded plug length ½ metre.
- * Good Quality, reliable terminal/sockets are provided at appropriate places on panel for connections/observation of waveforms.
- * Strongly supported by detailed Operating Instructions, giving details of Object, Theory, Design procedures, Report Suggestions and Book References.

Other Apparatus Required:

01. Dual Trace Cathode Ray Oscilloscope 20MHz (Unearthed)
02. Bulb 24V/7W

Universal Motor Speed Control

Order Code - 46529



Power Electronic Training Board has been designed specifically for the study of speed control of universal motors in different modes, such universal motors are series wound motors capable of operating on both A.C. and D.C. supply. This Training Board is capable of controlling the speed of universal motor up to 1/4th H.P. Capacity.

Practical experience on this board carries great educative value for Science and Engineering Students.

Object:

To perform the following experiments :

01. Half wave controller without feed back.
02. Half wave controller with feed back.
03. Half wave controller high torque at low speed version - skip cycling operation.
04. Full wave controller using triac and demonstrating hysteresis effects improved by gate slaving techniques.

Features:

The board consists of following built-in parts:

01. SCR and TRIAC for the speed control of the universal motor.
 02. Two potentiometers.
 03. Two capacitors to control firing angle of thyristors.
 04. DIAC and two Nos. of diodes.
 05. A Universal motor of 1/12 H.P. or less capacity.
 06. Snubber circuit in parallel with the triac, which helps in improving the Dv/Dt of the device and also helps in reducing the RFI.
 07. Adequate no. of other Electronic Components.
 08. Mains ON/OFF switch, Fuse and Jewel light.
- * The unit is operative on 230V ±10% at 50Hz A.C. Mains.
 - * Adequate no. of patch cords stackable 4 mm spring loaded plug length ½ metre.
 - * Good Quality, reliable terminal/sockets are provided at appropriate places on panel for connections/ observation of waveforms.
 - * Strongly supported by detailed Operating Instructions, giving details of Object, Theory, Design procedures, Report Suggestions and Book References.
 - * Weight : 3 Kg. (Approx.)

* Dimension : W 340 x H 110 x D 210

Other Apparatus Required:

01. Digital Multimeter 3¾ digit - Order Code 16501
02. Dual Trace Cathode Ray Oscilloscope 20MHz (Unearthed)

To Trigger a SCR by Using a LDR

Order Code - 46530



Power Electronic Training Board has been designed specifically to study trigger of a SCR by using a LDR. Practical experience on this board carries great educative value for Science and Engineering Students.

Object:

To trigger a SCR by using a LDR.

Features:

The board consists of the following built in parts :

01. 6VA.C. at 2 Amp power supply internally connected.
 02. SCR.
 03. LDR mounted on Panel.
 04. Two potentiometers for intensity and sensitivity control.
 05. Adequate no. of other electronic components.
 06. Mains ON/OFF switch, Fuse and Jewel light.
- * The unit is operative on 230V ±10% at 50Hz A.C. Mains.
 - * Good Quality, reliable terminal/sockets are provided at appropriate places on panel for connections / observation of waveforms.
 - * Strongly supported by detailed Operating Instructions, giving details of Object, Theory, Design procedures, Report Suggestions and Book References.
 - * Weight : 3 Kg. (Approx.)
 - * Dimension : W 340 x H 110 x D 210

Other Apparatus Required:

01. Digital Multimeter 3¾ digit - Order Code 16901
02. Cathode Ray Oscilloscope 20MHz

Single Phase Fully- Controlled Bridge Converter

Order Code - 46531



Power Electronic Training Board has been designed specifically to study and obtain the single phase fully controlled bridge converter. Practical experience on this board carries great educative value for Science and Engineering Students.

Object:

To study and obtain the single phase fully controlled bridge converter.

Features:

The board consists of the following built-in parts:

01. 230VA.C. Isolated Transformer, Power 50 watt.
 02. 9V D.C. at 100mA Zener Regulated Power Supply.
 03. Two UJT.
 04. Four SCR's.
 05. Two Pulse transformer 1:1:1.
 06. Two Potentiometers for controlling UJT firing angle.
 07. Bulb 40W, 230VA.C.
 08. Adequate no. of other Electronic Components.
 09. Mains ON/OFF switch, Fuse and Jewel light.
- * The unit is operative on 230V ±10% at 50Hz A.C. Mains.
 - * Adequate no. of patch cords stackable 4 mm spring loaded plug length ½ metre.
 - * Good Quality, reliable terminal/sockets are provided at appropriate places on panel for connections/observation of waveforms.

Other Apparatus Required:

01. Dual Trace Cathode Ray Oscilloscope 20 MHz (Unearthed)/with Isolation Transformer for unearthing.

SCR D.C. Circuit Breaker

Order Code - 46532



Power Electronic Training Board has been designed specifically to study the SCR as D.C. circuit breaker when the D.C. circuit exceeds specified limit. The set up works on 30V D.C. and permits the circuit breaker to be adjusted from 100mA to 1.8 Amp. This Training Board also includes Electronic Crow Bar circuitry to demonstrate the over voltage and over current trip under D.C. Condition. Practical experience on this board carries great educative value for Science and Engineering Students.

Object:

01. To study SCR turn OFF action under varying loads.
02. To study D.C. over voltage trip action.
03. To study over current trip action.

Features:

The board consists of the following built-in parts:

01. 20V D.C. Zener Stabilized Power Supply for UJTs.
 02. Two SCRs, one main and one auxiliary.
 03. Two push button switches, one to trigger the main SCR and other to trigger the auxiliary SCR which turns the main SCR OFF.
 04. Two UJTs connected in relaxation oscillator mode.
 05. Two potentiometers to adjust the over voltage and over current limit.
 06. Capacitor bank to study commutation under different load.
 07. Resistance bank for varying load.
 08. Adequate no. Of other Electronic Components.
 09. Fuse protection in D.C. supply.
- * The unit is operative on 30V D.C. at 2 Amp.
 - * Adequate no. of patch cords stackable 4 mm spring loaded plug length ½ metre.
 - * Good Quality, reliable terminal/sockets are provided at appropriate places on panel for

connections/observation of wave forms.

- * Strongly supported by detailed Operating Instructions, giving details of Object, Theory, Design procedures, Report Suggestions and Book References.

Other Apparatus Required:

01. Digital Multimeter 3¾ digit - Order Code 16901
02. 0-30V D.C.-2 Amp, IC Regulated Power Supply
03. Dual Trace Cathode Ray Oscilloscope 20MHz (Unearthed)

SCR Lamp Flasher

Order Code - 46533



Power Electronic Training Board has been designed specifically to study the use of SCR and TRIAC in D.C. and A.C. lamp flasher respectively. The flasher is useful for students of understand the application of SCRs in D.C. flasher, triggered by UJT relaxation oscillator. The repetition rate of the flasher can be varied by varying the frequency of the relaxation oscillator. This Training Board also makes use of the same SCR D.C. Flasher for making the TRIAC ON and OFF in the A.C. power circuit which operates a normal 230V incandescent lamp used as load.

Practical experience on this board carries great educative value for Science and Engineering Students.

Object:

To perform the following experiments :

01. Symmetrical D.C. flasher.
02. High power A.C. flasher.

Features:

The board consists of the following built-in parts:

01. 12V D.C. at 100mA, IC Regulated Power Supply.
 02. Two SCRs.
 03. TRIAC 4 Amp./400PIV
 04. 230V/40 Watt lamp for load.
 05. UJT 2N 2646 in relaxation oscillator mode.
 06. Two LEDs to demonstrate Twin-lamp D.C. flasher.
 07. Potentiometer for frequency variation.
 08. Two numbers of toggle switches, one for D.C. flasher, and one for A.C. flasher.
 09. Adequate no. of other Electronic Components.
 10. Mains ON/OFF switch, Fuse and Jewel light.
- * The unit is operative on 230V ±10% at 50Hz A.C. Mains.
 - * Adequate no. of patch cords stackable 4 mm spring loaded plug length ½ metre.
 - * Good Quality, reliable terminal/sockets are provided at appropriate places on panel for connections/ observation of waveforms.
 - * Strongly supported by detailed Operating Instructions, giving details of Object, Theory, Design procedures, Report Suggestions and Book References.

Other Apparatus Required:

01. Digital Multimeter 3¾ digit - Order Code 16901
02. Dual Trace Cathode Ray Oscilloscope 20MHz (Unearthed)

Triggering Circuits for SCR

Order Code - 46534



Power Electronic Training Board has been designed specifically for the study of SCR Triggering circuits. Practical experience on this board carries great educative value for Science and Engineering Students.

Object:

To study the SCR Triggering circuits using

01. Resistor (R) Triggering circuit
02. Resistor - capacitor (R-C) Triggering circuit
03. Uni-junction Transistor (UJT) Triggering circuit (UJT relaxation Oscillator)
04. Half-wave controlled rectifier
05. Full-wave controlled rectifier.

Features:

The board consists of the following built-in parts:

01. 35VA.C. at 100mA.A.C. Power Supply.
 02. Bridge rectifier for making D.C. voltage.
 03. Two Silicon controlled rectifier (SCR).
 04. Uni junction Transistor.
 05. Pulse transformer 1:1.
 06. Two potentiometer for varying load.
 07. Two potentiometer one for controlling SCR firing angle and other for controlling UJT firing angle.
 08. Adequate no. of other Electronic Components.
 09. Mains ON/OFF switch, Fuse and Jewel light.
- * The unit is operative on 230V ±10% at 50Hz A.C. Mains.
 - * Adequate no. of patch cords stackable 4 mm spring loaded plug length ½ metre.
 - * Good Quality, reliable terminal/sockets are provided at appropriate places on panel for connections/ observation of waveforms.
 - * Strongly supported by detailed Operating Instructions, giving details of Object, Theory, Design procedures, Report Suggestions and Book References.

Other Apparatus Required

01. Dual Trace Cathode Ray Oscilloscope 20MHz (Unearthed)

Single Phase Half Wave Controlled Converter

Order Code - 46535



Power Electronic Training Board has been designed specifically study of single phase half wave controlled converter.

Practical experience on this board carries great educative value for Science and Engineering Students.

Object:

Study and obtain the waveforms for single-phase half wave controlled converter.

Features:

The board consists of the following built-in parts:

01. 230VA.C. Isolated Transformer, Power 50 watt.
 02. 9V D.C. at 100mA Zener Regulated Power Supply.
 03. Silicon Controlled Rectifier (SCR).
 04. Uni Junction Transistor.
 05. Pulse transformer 1:1.
 06. Potentiometer for controlling UJT firing angle.
 07. Bulb 40W, 230VA.C.
 08. Adequate no. of other Electronic Components.
 09. Mains ON/OFF switch, Fuse and Jewel light.
- * The unit is operative on 230V ±10% at 50Hz A.C. Mains.
 - * Adequate no. of patch cords stackable 4 mm spring loaded plug length ½ metre.
 - * Good Quality, reliable terminal/sockets are provided at appropriate places on panel for connections/ observation of waveforms.
 - * Strongly supported by detailed Operating Instructions, giving details of Object, Theory, Design procedures, Report Suggestions and Book References.

Other Apparatus Required:

01. Dual Trace Cathode Ray Oscilloscope 20MHz (Unearthed)/with Isolation Transformer for unearthing.

Wave Controlled Converter

Order Code - 46536



Power Electronic Training Board has been designed specifically to study and obtain the waveforms for single phase half controlled symmetrical & asymmetrical bridge converter.

Practical experience on this board carries great educative value for Science and Engineering Students.

Object:

01. To study and obtain the single phase half controlled symmetrical bridge converter.
02. To study and obtain the single phase half controlled asymmetrical bridge converter.

Features:

The board consists of the following built-in parts:

01. An isolation transformer 230VA.C. at 200mA. This protects external instruments for damage if they are not isolated.
02. 6VAC at 100mAAC Power Supply.
03. ±12V DC at 100mA fixed regulated Power Supply.
04. Two Op-Amp's. IC.
05. Quad, Ex-OR gate IC.
06. Triple, 3 input AND gate IC.
07. Hex inverter gate IC.
08. Quad, two input AND gate IC.
09. Three NPN Transistor.
10. Two SCR's.
11. Potentiometer for reference voltage adjustment.
12. Two Pulse Transformer 1: 1.
13. 40 watt bulb.
14. Adequate no. of other Electronic Components.
15. Mains ON/OFF switch, Fuse and Jewel light.

- * The unit is operative on 230V ±10% at 50Hz A.C. Mains.
- * Adequate no. of patch cords stackable 4 mm spring loaded plug length ½ metre.
- * Good Quality, reliable terminal/sockets are provided at appropriate places on panel for connections/observation of waveforms.
- * Strongly supported by detailed Operating Instructions, giving details of Object, Theory, Design procedures, Report Suggestions and Book References.
- * Weight : 7 Kg. (Approx.)
- * Dimension : W 412 x H 150 x D 310

Other Apparatus Required:

01. Dual Trace Cathode Ray Oscilloscope 20MHz (Unearthed)

AC Regulators Using Triac, Anti Parallel Thyristor and Triac & Diac

Order Code - 46537



Power Electronic Training Board has been designed specifically for to study A.C. Regulators using triac, antiparallel thyristor and triac & diac.

Practical experience on this board carries great educative value for Science and Engineering Students.

Object:

01. A.C. Regulator using a Triac.
02. A.C. Regulator using Thyristor connected in antiparallel.
03. A.C. Regulator using a triac & a diac (with R.C. triggering circuit).

Features:

The board consists of the following built-in parts :

01. 230VA.C. Isolated Transformer, Power 50 Watt.
 02. 9V D.C. at 100mA Zener Regulated Power Supply.
 03. Two silicon controlled rectifiers (SCR's).
 04. Uni Junction Transistor (UJT).
 05. TRIAC.
 06. DIAC.
 07. Pulse Transformer 1:1:1.
 08. Two potentiometers one for controlling UJT firing angle & other for varying load.
 09. Bulb 40W, 230VA.C.
- * Mains ON/OFF switch, Fuse and Jewel light.
 - * The unit is operative on 230V ±10% at 50Hz A.C. Mains.
 - * Adequate no. of patch cords stackable 4 mm spring loaded plug length ½ metre.
 - * Good Quality, reliable terminal/sockets are provided at appropriate places on panel for connections/ observation of waveforms.
 - * Strongly supported by detailed Operating Instructions, giving details of Object, Theory, Design procedures, Report Suggestions and Book References.

Other Apparatus Required:

01. Dual Trace Cathode Ray Oscilloscope 20MHz (Unearthed)/with isolation transformer for unearthing.

Single Phase PWM Converter

Order Code - 46538



Power Electronic Training Board has been designed specifically for study of single phase PWM converter. Practical experience on this board carries great educative value for Science and Engineering Students.

Object:

To Study Single Phase PWM Converter.

Features:

The board consists of the following built-in parts :

01. 6VA.C. at 100mAAC Power Supply.
 02. 30VA.C. at 100mAAC Power Supply.
 03. $\pm 12V$ D.C. at 100mA fixed regulated Power Supply.
 04. Timer.
 05. Op-Amp.
 06. Hex inverter gate.
 07. Quad Ex-OR gate.
 08. Two NPN Transistor.
 09. One NPN Power Transistor.
 10. Uni junction transistor (UJT).
 11. Three Potentiometers.
 12. Load.
 13. Adequate no. of other Electronic Components.
 14. Mains ON/OFF switch, Fuse and Jewel light.
- * The unit is operative on 230V $\pm 10\%$ at 50Hz A.C. Mains.
 - * Adequate no. of patch cords stackable 4 mm spring loaded plug length $\frac{1}{2}$ meter.
 - * Good Quality, reliable terminal/sockets are provided at appropriate places on panel for connections/ observation of waveforms.
 - * Strongly supported by detailed Operating Instructions, giving details of Object, Theory, Design procedures, Report Suggestions and Book References.

Other Apparatus Required:

01. Dual Trace Cathode Ray Oscilloscope 20MHz (Unearthed)

Firing Circuit Using Ramp Comparator Scheme

Order Code - 46539



Power Electronic Training Board has been designed specifically for the study of the firing circuit for single-phase converter using Ramp Comparator Scheme. Practical experience on this board carries great educative value for Science and Engineering Students.

Object:

To study the firing circuit for single-phase converter using Ramp Cooperator Scheme.

Features:

The board consists of the following built-in parts:

01. 6VAC at 100mAAC Power Supply.
 02. $\pm 12V$ DC at 100mA fixed regulated Power Supply.
 03. Two Op-Amp's. IC
 04. Quad, Ex-OR gate IC.
 05. Triple, 3 input AND gate IC.
 06. Hex inverter gate IC.
 07. Quad, two input AND gate IC.
 08. Two NPN Transistor.
 09. Potentiometer for reference voltage adjustment.
 10. Pulse Transformer 1: 1.
 11. Adequate no. of other Electronic Components.
 12. Mains ON/OFF switch, Fuse and Jewel light.
- * The unit is operative on 230V $\pm 10\%$ at 50Hz A.C. Mains.
 - * Adequate no. of patch cords stackable 4 mm spring loaded plug length $\frac{1}{2}$ meter.
 - * Good Quality, reliable terminal/sockets are provided at appropriate places on panel for connections/ observation of waveforms.
 - * Strongly supported by detailed Operating Instructions, giving details of Object, Theory, Design procedures, Report Suggestions and Book References.

Other Apparatus Required

01. Dual Trace Cathode Ray Oscilloscope 20MHz (Unearthed)
02. OPTIONAL : Unit for above experiment to work as a load having
03. Isolation Transformer 50 watt.
04. Lamp 40 watt
05. SCR 400V 4A
06. Mains ON/OFF switch, Fuse & Jewel light.

Firing Circuit Using OP-AMPS And Gates

Order Code - 46540



Power Electronic Training Board has been designed specifically for the study of the firing circuit for single-phase converter using Op-Amps and Gates.

Practical experience on this board carries great educative value for Science and Engineering Students.

Object:

To study firing circuit for single-phase converter using Op-Amps and Gates.

Features:

The board consists of the following built-in parts:

01. 6VAC at 100mA, AC Power Supply.
 02. $\pm 12V$ DC at 100mA fixed regulated Power Supply.
 03. Eight Op-Amp's IC,
 04. Quad 2 input AND gate IC.
 05. Two NPN Transistors.
 06. Two Pulse Transformers 1:1.
 07. Three Potentiometers.
 08. Adequate no. of other Electronic Components.
 09. Mains ON/OFF switch, Fuse and Jewel light.
- * The unit is operative on 230V $\pm 10\%$ at 50Hz A.C. Mains.

- * Adequate no. of patch cords stackable 4 mm spring loaded plug length ½ meter.
- * Good Quality, reliable terminal/sockets are provided at appropriate places on panel for connections/ observation of waveforms.
- * Strongly supported by detailed Operating Instructions, giving details of Object, Theory, Design procedures, Report Suggestions and Book References.

Other Apparatus Required:

01. Dual Trace Cathode Ray Oscilloscope 20MHz (Unearthed)
02. OPTIONAL : Unit for above experiment to work as a load having
03. Isolation Transformer 50 watt.
04. Lamp 40 watt
05. SCR 400V 4A
06. Mains ON/OFF switch, Fuse & Jewel light.

Firing Circuit using Cosine-Wave Scheme

Order Code - 46541



Power Electronic Training Board has been designed specifically for the study of the firing circuit for single-phase converter using cosinewave comparator scheme. Practical experience on this board carries great educative value for Science and Engineering Students.

Object:

To Study firing circuit for single-phase converter using Cosine-Wave Comparator Scheme.

Features:

- The board consists of the following built-in parts:
01. 6VAC at 100mA, AC Power Supply.
 02. ±12V DC at 100mA fixed regulated Power Supply.
 03. Six Op-Amps IC.
 04. Triple, 3 input AND gate IC.
 05. Four NPN Transistor.
 06. Two Potentiometer.
 07. Two Pulse Transformer 1:1:1.
 08. Adequate no. of other Electronic Components.
 09. Mains ON/OFF switch, Fuse and Jewel light.
 - * The unit is operative on 230V ±10% at 50Hz A.C. Mains.
 - * Adequate no. of patch cords stackable 4 mm spring loaded plug length ½ meter.
 - * Good Quality, reliable terminal/sockets are provided at appropriate places on panel for connections/ observation of waveforms.
 - * Strongly supported by detailed Operating Instructions, giving details of Object, Theory, Design procedures, Report Suggestions and Book References.

Other Apparatus Required:

01. Dual Trace Cathode Ray Oscilloscope 20MHz (Unearthed)
02. OPTIONAL : Unit for above experiment to work as a load having
03. Isolation Transformer 50 watt.

04. Lamp 40 watt * SCR 400V 4A
05. Mains ON/OFF switch, Fuse & Jewel light.

Single Phase Series Inverter

Order Code - 46542



Power Electronic Training Board has been designed specifically for study of the Single Phase Series Inverter.

Practical experience on this board carries great educative value for Science and Engineering Students.

Object:

To study the Single Phase Series Inverter.

Features:

- The board consists of the following built-in parts:
01. 12V DC at 100mA fixed regulated Power Supply.
 02. Bridge rectifier for making DC voltage.
 03. Hex Inverter IC.
 04. Quad, 2-input AND gate IC.
 05. Two Silicon Controlled Rectifiers (SCR's).
 06. Two Pulse transformer 1:1.
 07. Potentiometer for inverter frequency controller.
 08. Center taped Inductor.
 09. Two NPN transistor.
 10. Adequate no. of other Electronic Components.
 11. Mains ON/OFF switch, Fuse and Jewel light.
 - * The unit is operative on 230V ±10% at 50Hz A.C. Mains.
 - * Adequate no. of patch cords stackable 4 mm spring loaded plug length ½ metre.
 - * Good Quality, reliable terminal/sockets are provided at appropriate places on panel for connections/ observation of waveforms.
 - * Strongly supported by detailed Operating Instructions, giving details of Object, Theory, Design procedures, Report Suggestions and Book References.

Other Apparatus Required:

01. Dual Trace Cathode Ray Oscilloscope 20MHz (Unearthed)

SCR Parallel Inverter

Order Code - 46543

Power Electronic Training Board has been designed specifically for the study of SCR Parallel Inverter. Practical experience on this board carries great educative value for Science and Engineering Students.

Object:

To study the SCR Parallel Inverter.

Features:

- The board consists of the following built-in parts:
01. 12V DC at 100mA fixed regulated Power Supply.
 02. 12V DC at 3 Amp. Power Supply.
 03. 9 - 0-9 VAC at 3 Amp. transformer
 04. UJT to generate ramp.
 05. IC-1 to drive Tr. 4 and Tr. 5.
 06. Tr. 4 and Tr. 5 for generation of pulses.

07. Pulse transformer 1:1:1.
 08. Tr. 1, 2 and 3 for relay operation.
 09. Two SCRs.
 10. Two push-to-ON switches for putting inverter ON/OFF.
 11. Relay 12V DC.
 12. 25 watt. Lamp with Socket.
 13. Adequate no. of other electronic components.
 14. Mains ON/OFF switch, Fuse and Jewel light.
- * The unit is operative on 230V \pm 10% at 50Hz A.C. Mains.
 - * Good Quality, reliable terminal/sockets are provided at appropriate places on panel for connections/ observation of waveforms.
 - * Strongly supported by detailed Operating Instructions, giving details of Object, Theory, Design procedures, Report Suggestions and Book References.

Other Apparatus Required:

01. Dual Trace Cathode Ray Oscilloscope 20MHz (Unearthed)/with isolation transformer for unearthing.

Single Phase Transistorised Bridge Inverter

Order Code - 46544

Power Electronic Training Board has been designed specifically for study of Single Phase Transistorised Bridge Inverter.

Practical experience on this board carries great educative value for Science and Engineering Students.

Object:

To study the Single Phase Transistorised Bridge Inverter.

Features:

The board consists of the following built-in parts:

01. Three \pm 12V DC at 30mA Regulated Power Supply.
 02. One +12V DC at 200mA Regulated Power Supply.
 03. One +5V DC at 100mA Regulated Power Supply.
 04. Two Monostable Multivibrator IC.
 05. Quad Exclusive -OR gate IC.
 06. Hex Inverter IC.
 07. Four Opto-coupler IC.
 08. Twelve NPN Transistor.
 09. Four PNP Transistor.
 10. Four Power NPN Transistor.
 11. One Potentiometer .
 12. Mains ON/OFF switch, Fuse and Jewel light.
- * The unit is operative on 230V \pm 10% at 50Hz A.C. Mains.
 - * Adequate no. of patch cords stackable 4 mm spring loaded plug length 1/2 meter.
 - * Good Quality, reliable terminal/sockets are provided at appropriate places on panel for connections/ observation of waveforms.
 - * Strongly supported by detailed Operating Instructions, giving details of Object, Theory, Design procedures, Report Suggestions and Book References.

Other Apparatus Required:

01. Dual Trace Cathode Ray Oscilloscope 20MHz (Unearthed)
02. Isolation transformer 50W for unearthing the oscilloscope

Forced Commutated Circuits

Order Code - 46545



Power Electronic Training Board has been designed specifically for to study the forced commutated circuits. Practical experience on this board carries great educative value for Science and Engineering Students.

Object:

To study the forced commutated circuits.

01. Class - A or self commutation by resonating the load.
02. Class - B or self commutation by an LC circuit.
03. Class - C or commutation through charged capacitor switched by another load carrying. SCR
- 04 Class - D or commutation through charged capacitor switched by an auxillary SCR.
05. Class - E or an External pulse source commutation.

Features:

The board consists of the following built-in parts :

01. 30V D.C. at 150mA Fixed Power Supply.
 02. 5V D.C. at 50mA Fixed Power Supply.
 03. 5Hz Square wave Oscillator.
 04. UJT Triggering Circuit for SCR's.
 05. Two PUSH-TO-ON switch.
 06. NPN Transistor.
 07. Inductor.
 08. Diode & LED.
 08. Capacitor Bank.
 09. Adequate no. of other Electronic Components.
 10. Mains ON/OFF switch, Fuse and Jewel light.
 11. The unit is operative on 230V \pm 10% at 50Hz A.C. Mains.
- * Adequate no. of patch cords stackable 4 mm spring loaded plug length 1/2 metre.
 - * Good Quality, reliable terminal/sockets are provided at appropriate places on panel for connections/ observation of waveforms.
 - * Strongly supported by detailed Operating Instructions, giving details of Object, Theory, Design procedures, Report Suggestions and Book References.

Other Apparatus Required:

01. Dual Trace Cathode Ray Oscilloscope 20MHz (Unearthed)

Voltage Commutated Thyristorised Chopper

Order Code - 46546



Power Electronic Training Board has been designed specifically for the study of the step down voltage commutated thyristorised chopper.

Practical experience on this board carries great educative value for Science and Engineering Students.

Object:

To study the step down voltage commutated thyristorised chopper.

Features:

The board consists of the following built-in parts:

01. $\pm 12V$ D.C. at 100mA IC regulated power supply internally connected.
02. 5V D.C. at 100mA IC regulated power supply internally connected.
03. Bridge Rectifier for making D.C. voltage.
04. UJT as relaxation oscillator.
05. Op-Amp. IC.
06. Timer IC.
07. Hex Inverter Gate IC.
08. Two SCR's.
09. Two pulse transformer 1:1:1.
10. Two NPN transistor.
11. Two SPST switch.
12. Push-To-On switch.
13. Free wheeling diode.
14. Inductors.
15. Bulb 12V, 6W.
16. Adequate no. of other Electronic Components.
17. Mains ON/OFF switch, Fuse and Jewel light.
- * The unit is operative on 230V $\pm 10\%$ at 50Hz A.C. Mains.
- * Adequate no. of patch cords stackable 4 mm spring loaded plug length $\frac{1}{2}$ metre.
- * Good Quality, reliable terminal/sockets are provided at appropriate places on panel for connections/ observation of waveforms.
- * Strongly supported by detailed Operating Instructions, giving details of Object, Theory, Design procedures, Report Suggestions and Book References.

Other Apparatus Required:

01. Dual Trace Cathode Ray Oscilloscope 20MHz (Unearthed)

Current Commutated Thyristorised Chopper

Order Code - 46547



Power Electronic Training Board has been designed specifically for the study of the step down current commutated thyristorised chopper. Practical experience on this board carries great educative value for Science and Engineering Students.

Object:

To study the step down current commutated thyristorised chopper.

Features:

The board consists of the following built-in parts:

01. $\pm 12V$ D.C. at 100mA IC regulated power supply internally connected.
02. 5V D.C. at 100mA IC regulated power supply internally connected.
03. Bridge Rectifier for making D.C. voltage.
04. UJT as relaxation oscillator.
05. Op-Amp. IC.
06. Timer IC.

07. Hex Inverter Gate IC.
08. Two SCR's.
09. Two pulse transformer 1:1.
10. Two NPN transformer.
11. Inductors.
12. Two potentiometer one for frequency control and other reference voltage ADJ.
13. Adequate no. of other Electronic Components.
14. Mains ON/OFF switch, Fuse and Jewel light.
- * The unit is operative on 230V $\pm 10\%$ at 50Hz A.C. Mains.
- * Adequate no. of patch cords stackable 4 mm spring loaded plug length $\frac{1}{2}$ metre.
- * Good Quality, reliable terminal/sockets are provided at appropriate places on panel for connections/ observation of waveforms.
- * Strongly supported by detailed Operating Instructions, giving details of Object, Theory, Design procedures, Report Suggestions and Book References.

Other Apparatus Required:

01. Dual Trace Cathode Ray Oscilloscope 20MHz (Unearthed).

Effect Of FreeWheeling Diode in Single Phase Fully-controlled Bridge Converter

Order Code - 46548

Power Electronic Training Board has been designed specifically to study and obtain the single phase fully controlled bridge converter using (i) R-load (ii) R-L load and (iii) effect of free wheeling diode in R-L load. Practical experience on this board carries great educative value for Science and Engineering Students.

Object:

To study and obtain the single phase fully controlled bridge converter using (i) R-load (ii) R-L load and (iii) effect of free wheeling diode in R-L load.

Features:

The board consists of the following built-in parts:

01. 35V D.C. at 500mA Zener Regulated Power Supply.
02. Bridge rectifier for making DC voltage.
03. Two UJT.
04. Four SCR's.
05. Two Pulse transformer 1:1:1.
06. Two Potentiometers for controlling UJT firing angle.
07. Bulb 12V 5W.
08. Inductor 20mH.
09. Adequate no. of other Electronic Components.
10. Mains ON/OFF switch, Fuse and Jewel light.
- * The unit is operative on 230V $\pm 10\%$ at 50Hz A.C. Mains.
- * Adequate no. of patch cords stackable 4 mm spring loaded plug length $\frac{1}{2}$ metre.
- * Good Quality, reliable terminal/sockets are provided at appropriate places on panel for connections/ observation of waveforms.
- * Strongly supported by detailed Operating Instructions, giving details of Object, Theory, Design procedures, Report Suggestions and Book References.

Other Apparatus Required:

01. Dual Trace Cathode Ray Oscilloscope 20 MHz (Unearthed)/with Isolation Transformer for

unearthing.

To Study And Plot VI Characteristics of a Power Mosfet

Order Code - 46549

Specifically to study and Plot VI Characteristics of A Power MosFet. The board is absolutely self contained. Practical experience on this board carries great educative value for Science and Engineering Students.

Object:

- 01. To study and Plot VI Characteristic of a Power MosFet.
- 02. Switching Characteristic of a Power MosFet.

Features:

The board consists of the following built-in parts:

- 01. IC regulated power supply 0-10V at 30mA.
- 02. IC regulated power supply 0-60V at 200mA.
- 03. Digital DC voltmeter ranges 0-20V.
- 04. Digital DC voltmeter ranges 0-200V.
- 05. Digital DC Ammeter with selectable switch range 0-2/20mA.
- 06. Power MosFet.
- 07. Adequate nos. of other electronic components.
- 08. Mains ON/OFF switch & Fuse.
- 09. The unit is operative on 230V ±10% at 50Hz.
- * Adequate no. of patch cords stackable 4 mm spring loaded plug length ½ metre.
- * Good Quality, reliable terminal/sockets are provided at appropriate places on panel for connections/ observation of waveforms.
- * Strongly supported by detailed Operating Instructions, giving details of Object, Theory, Design procedures, Report Suggestions and Book References.

Other Apparatus Required:

- 01. Dual Trace Cathode Ray Oscilloscope 20 MHz
- 02. Function Generator.

UJT Firing Circuit Of SCR

Order Code - 46550



Power Electronic Training Board has been designed specifically for UJT Firing Circuit of SCR. Practical experience on this board carries great educative value for Science and Engineering Students.

Object:

To study UJT Firing Circuit of SCR.

Features:

The board consists of the following built-in parts:

- 01. An isolation transformer 230VA.C. 200mA. This protects external instruments for damage if they are not isolated.
- 02. Bridge rectifier for making D.C. voltage.
- 03. Uni Junction Transistor.
- 04. Zener Diode.
- 05. Silicon Controlled Rectifier (SCR).
- 06. Pulse Transformer.

- 07. Potentiometer to Control Firing Angle.
- 08. Lamp load.
- 09. Adequate no. of other Electronic Components.
- 10. Mains ON/OFF switch, Fuse and Jewel light.
- * The unit is operative on 230V ±10% at 50Hz A.C. Mains.
- * Adequate no. of patch cords stackable 4 mm spring loaded plug length ½ meter.
- * Good Quality, reliable terminal/sockets are provided at appropriate places on panel for connections/ observation of waveforms.
- * Strongly supported by detailed Operating Instructions, giving details of Object, Theory, Design procedures, Report Suggestions and Book References.

Other Apparatus Required:

- * Dual Trace Cathode Ray Oscilloscope 20MHz (Unearthed)

Lamp Dimmer Using Diac and Triac

Order Code - 46551



Power Electronic Training Board has been designed specifically to study Lamp Dimmer Using Diac and Triac. The board is absolutely self contained and requires no other apparatus. Practical experience on this board carries great educative value for Science and Engineering Students.

Object:

To study Lamp Dimmer Using Diac and Triac.

Features:

The board consists of the following built-in parts:

- 01. An Isolation Transformer having output 230VAC at 200mA.
- 02. Triac
- 03. Diac.
- 04. Lamp load.
- 05. Potentiometer to control intensity of Lamp.
- 06. Adequate no. of other Electronic Components.
- 07. Mains ON/OFF switch, Fuse and Jewel light.
- * The unit is operative on 230V ±10% at 50Hz A.C. Mains.
- * Adequate no. of patch cords stackable 4 mm spring loaded plug length ½ metre.
- * Good Quality, reliable terminal/sockets are provided at appropriate places on panel for connections/ observation of waveforms.
- * Strongly supported by detailed Operating Instructions, giving details of Object, Theory, Design procedures, Report Suggestions and Book References.

Illumination Control Using SCR

Order Code - 46552

Power Electronic Training Board has been designed specifically for the study Illumination control using SCR. The board is absolutely self contained and requires no other apparatus. Practical experience on this board carries great

educative value for Science and Engineering Students.

Object:

To study the Illumination control using SCR.

Features:

The board consists of the following built-in parts:

01. An Isolation Transformer having output 230VAC at 200mA.
02. Uni Junction Transistor.
03. Silicon Control Rectifier (SCR).
04. Bridge rectifier for making D.C. voltage.
05. Lamp load.
06. Potiometer to control Illumination.
07. Zener diode.
08. Adequate no. of other Electronic Components.
09. Mains ON/OFF switch, Fuse and Jewel light.
- * The unit is operative on 230V ±10% at 50Hz A.C. Mains.
- * Adequate no. of patch cords stackable 4 mm spring loaded plug length ½ metre.
- * Good Quality, reliable terminal/sockets are provided at appropriate places on panel for connections/ observation of waveforms.
- * Strongly supported by detailed Operating Instructions, giving details of Object, Theory, Design procedures, Report Suggestions and Book References.

Fan Regulator Using Diac and Triac

Order Code - 46553



Power Electronic Training Board has been designed specifically for the study of Fan Regulator Using Diac and Triac. The board is absolutely self contained and requires no other apparatus.

Practical experience on this board carries great educative value for Science and Engineering Students.

Object:

To study Fan Regulator Using Diac and Triac.

Features:

The board consists of the following built-in parts:

01. Isolation Transformer 230VA.C., Power 70 watt.
02. Diac.
03. Triac.
04. Potentiometer to control the speed of Motor / Fan.
05. A universal motor of 1/12 H.P.
06. Adequate no. of other Electronic Components.
07. Mains ON/OFF switch, Fuse and Jewel light.
- * The unit is operative on 230V ±10% at 50Hz A.C. Mains.
- * Adequate no. of patch cords stackable 4 mm spring loaded plug length ½ metre.
- * Good Quality, reliable terminal/sockets are provided at appropriate places on panel for connections/ observation of waveforms.
- * Strongly supported by detailed Operating Instructions, giving details of Object, Theory, Design procedures, Report Suggestions and Book References.

SCR Controlled Emergency Light

Order Code - 46554

Power Electronic Training Board has been designed specifically for the study of SCR Controlled Emergency Light. The board is absolutely self contained and requires no other apparatus.

Practical experience on this board carries great educative value for Science and Engineering Students.

Object:

To study SCR Controlled Emergency Light.

Features:

The board consists of the following built-in parts:

01. A step down transformer 6V at 2Amp.
02. Silicon Control Rectifier (SCR).
03. Lamp load.
04. Four diodes.
05. 6V 4AH Battery.
06. Adequate no. of other Electronic Components.
07. Mains ON/OFF switch, Fuse and Jewel light.
- * The unit is operative on 230V ±10% at 50Hz A.C. Mains.
- * Adequate no. of patch cords stackable 4 mm spring loaded plug length ½ metre.
- * Good Quality, reliable terminal/sockets are provided at appropriate places on panel for connections/ observation of waveforms.
- * Strongly supported by detailed Operating Instructions, giving details of Object, Theory, Design procedures, Report Suggestions and Book References.

Electronic Timer Using IC-555

Order Code - 46555



Power Electronic Training Board has been designed specifically for the study of Electronic Timer using IC-555. The board is absolutely self contained and requires no other apparatus.

Practical experience on this board carries great educative value for Science and Engineering Students.

Object:

To study Electronic Timer Using IC-555

Features:

The board consists of the following built-in parts:

01. 12V D.C. at 100mA, IC regulated Power Supply.
02. IC-555 as timer.
03. Push button as start switch.
04. 12 Volt relay.
05. Potentiometer to control time delay.
06. Adequate no. of other Electronic Components.
07. Mains ON/OFF switch, Fuse and Jewel light.
- * The unit is operative on 230V ±10% at 50Hz A.C. Mains.
- * Adequate no. of patch cords stackable 4 mm spring loaded plug length ½ metre.
- * Good Quality, reliable terminal/sockets are provided at appropriate places on panel for

connections/ observation of waveforms.

- * Strongly supported by detailed Operating Instructions, giving details of Object, Theory, Design procedures, Report Suggestions and Book References.

Three Phase Half Wave Rectifier

Order Code - 46556



Power Electronic Training Board has been designed specifically for the study of three phase half wave rectifier.

Practical experience on this board carries great educative value for Science and Engineering Students.

Object:

01. To observe the phase relation between the voltage waveforms in a three phase supply.
02. To observe the load waveforms & their phase in a three phase half wave rectifier with resistive load.

Features:

The board consists of the following built-in parts:

01. Three phase transformer.
 02. Digital Panel meter 3½ digits range 200V to measure the d.c. output voltage.
 03. Digital Panel meter 3½ digits range 200mA to measure the d.c. load current.
 04. 3 pole power contactor with AC coil complete with push to ON switch.
 05. Four pole Miniature Circuit Breaker (MCB).
 06. Three different colour neon indicator provided for indication .
 07. Resistive load 600E, 10 Watt.
 08. Three rectifier diodes.
 09. Three SPST switches.
 10. Three phase 415V at 50Hz, 20Amp. socket.
- * The unit is operative on 3-f 415V at 50Hz A.C. Mains.
 - * Adequate no. of patch cords stackable 4 mm spring loaded plug length ½ metre.
 - * Good Quality, reliable terminal/sockets are provided at appropriate places on panel for connections/ observation of waveforms.

Other Apparatus Required:

01. Dual Trace Cathode Ray Oscilloscope 20MHz (Unearthed)
02. Isolation transformer 50W for unearthing the oscilloscope.

Three Phase Full Wave Rectifier

Order Code - 46557



Power Electronic Training Board has been designed specifically for the study of three phase full wave

rectifier.

Practical experience on this board carries great educative value for Science and Engineering Students.

Object:

To study three phase full wave rectifier.

Features:

The board consists of the following built-in parts:

01. Three phase transformer.
 02. Digital Panel meter 3½ digits range 200V to measure the DC output voltage.
 03. Digital Panel meter 3½ digits range 200mA to measure the d.c. load current.
 04. 3 pole power contactor with AC coil complete with push to ON switch.
 05. Four pole Miniature Circuit Breaker (MCB).
 06. Three different colour neon indicator provided for indication .
 07. Resistive load 600E, 10 Watt.
 08. Six rectifier diodes.
 09. Six SPST switches.
 10. Three phase 415V at 50Hz, 20Amp. socket.
- * The unit is operative on 3-f 415V at 50Hz A.C. Mains.
 - * Adequate no. of patch cords stackable 4 mm spring loaded plug length ½ meter.
 - * Good Quality, reliable terminal/sockets are provided at appropriate places on panel for connections observation of wave forms.

Other Apparatus Required;

01. Dual Trace Cathode Ray Oscilloscope 20MHz (Unearthed)
02. Isolation transformer 50W for unearthing the oscilloscope

Three Phase Half Controlled Thyristorized Bridge Converter With Triggering Circuit

Order Code - 46558



Power Electronic Training Board has been designed specifically for the study of Three Phase Half Controlled Thyristorized Bridge Converter with Triggering Circuit.

Practical experience on this board carries great educative value for Science and Engineering Students.

Object:

01. To study the nature and generation of Control Signal for 3 phase Half wave Controlled Rectifier.
02. To study the operation of a 3f Half Wave controlled bridge rectifier with R load.
03. To study the operation of a 3f Half Wave controlled bridge rectifier with R-L load.
04. To study the effect of free wheeling diode on the output waveform.

Features:

The board consists of the following built-in parts:

01. Three Phase line commuted half-controlled thyristorized bridge converter.
02. Three pole power contractor with AC coil complete

with Push-to-ON switch.

03. Four pole Miniature Circuit Breaker (MCB).
04. Three separate identical cards consisting of Zero Crossing Detector, Integrator, Comparator and Pulse Generator one for each phase, for controlling the triggering angles of the positive group of three thyristors.
05. Firing angle control potentiometer.
06. Three 415 : 6V transformers AC supply for Triggering.
07. Three 415 : 50V at 1 Amp transformers for rectifications.
08. $\pm 12V$ & $+5V$ DC at 500mA, IC Regulator Power Supply for Triggering Circuits.
09. Three nos. Driver Circuits with Pulse Transformers.
10. High Frequency Gated Dual Gate Firing 3 nos.
11. R and L load with Load voltage divider.
12. Two $3\frac{1}{2}$ digital panel meter (DPM) for measurement of voltage and current.
13. One freewheel diode.
14. Unearthed mains sockets for CRO.
15. Adequate no. of other Electronic Components.
16. The jewel light in Red, Blue & Yellow colour.
- * The unit is operative on 3-f 415V at 50Hz A.C. Mains.
- * Adequate no. of patch cords stackable 4 mm spring loaded plug length $\frac{1}{2}$ metre.
- * Good Quality, reliable terminal/sockets are provided at appropriate places on panel for connections/ observation of waveforms.
- * Strongly supported by detailed Operating Instructions, giving details of Object, Theory, Design procedures, Report Suggestions and Book References..

Other Apparatus Required:

01. Dual Trace Cathode Ray Oscilloscope 20MHz (Unearthed)

Three Phase Fully Controlled Thyristorized Bridge Converter With Triggering Circuit

Order Code - 46559



Power Electronic Training Board has been designed specifically for the study of Three Phase Fully Controlled Thyristorized Bridge Converter with Triggering Circuit. Practical experience on this board carries great educative value for Science and Engineering Students.

Object:

01. To study the nature and generation of Control Signal for 3 phase Full-wave Controlled Rectifier.
02. To study the operation of a 3 phase Full-wave Controlled Bridge Rectifier with R load.
03. To study the operation of a 3 phase Full-wave Controlled Bridge Rectifier with R-L load.
04. To study the effect of Free Wheeling Diode on the output waveform.

Features:

The board consists of the following built-in parts:

01. Three Phase line commuted fully-controlled thyristorized bridge converter.
02. Three pole power contractor with AC coil complete with Push-to-ON switch.
03. Four pole Miniature Circuit Breaker (MCB).
04. Three separate identical cards consisting of Zero Crossing Detector, Integrator, Comparator and Pulse Generator one for each phase, for controlling the triggering angles of the positive group of three thyristors. Another card in conjunction with above three cards for controlling the triggering angles of the negative group of three thyristors.
05. Firing angle control potentiometer.
06. Three 415 : 6 V Transformers AC supply for Triggering.
07. Three 415 : 50 V at 1 Amp Transformer for rectification.
08. $\pm 12V$ at 500mA, IC Regulator Power Supply for Triggering Circuits.
09. 5V at 500mA, IC Regulator Power Supply for Triggering Circuits.
10. Six nos. Driver Circuits with Pulse Transformers.
11. High Frequency Gated Dual Gate Firing 6 nos.
12. R and L load with Load voltage divider.
13. Two $3\frac{1}{2}$ digital panel meter (DPM) for measurement of voltage and current.
14. One freewheel diode.
15. Unearthed mains sockets for CRO.
16. Adequate no. of other Electronic Components.
17. Three Jewel light in red, Yellow and Blue Colour
- * The unit is operative on 3-f 415V at 50Hz A.C. Mains.
- * Adequate no. of patch cords stackable 4 mm spring loaded plug length $\frac{1}{2}$ metre.
- * Good Quality, reliable terminal/sockets are provided at appropriate places on panel for connections/ observation of waveforms.
- * Strongly supported by detailed Operating Instructions, giving details of Object, Theory, Design procedures, Report Suggestions and Book References.

Other Apparatus Required:

01. Dual Trace Cathode Ray Oscilloscope 20MHz (Unearthed)

Zero Voltage Switching

Order Code - 46560



Power Electronic Training Board has been designed specifically for the study of Zero voltage switching board.

Practical experience on this board carries great educative value for Science and Engineering Students.

Object:

To study operation of zero voltage switching of thyristor.

Features:

The board consists of the following built-in parts:

01. A transformer to give low AC voltage to Thyristor and DC voltage to transistor.
02. Two diode used as fullwave rectifier.

03. One diode to avoid -ve voltage to collector of NPN transistor.
04. A NPN transistor.
05. A Thyristor.
06. Adequate no. of other Electronic Components.
07. Mains ON/OFF switch, Fuse and Jewel light.
- * The unit is operative on 230V \pm 10% at 50Hz A.C. Mains.
- * Good Quality, reliable terminal/sockets are provided at appropriate places on panel for connections/ observation of waveforms.
- * Strongly supported by detailed Operating Instructions, giving details of Object, Theory, Design procedures, Report Suggestions and Book References.

Other Apparatus Required:

01. Digital Multimeter - Order Code 16901
02. Dual Trace Cathode Ray Oscilloscope 20MHz (Unearthed/with isolation transformer for unearthing).

Power Transistor Characteristics

Order Code - 46561

Power Electronic Training Board has been designed specifically to study Power Transistor input and output Characteristics in common Emitter Configuration and Switching Characteristics of NPN Transistor. The board is absolutely self contained. Practical experience on this board carries great educative value for Science and Engineering Students.

Object:

- * To study & plot the Input Characteristics of Power Transistor in Common Emitter Configuration.
- * To study & plot the Output Characteristics of Power Transistor in Common Emitter Configuration.
- * To study the Switching Characteristics of Power Transistor.

Feature:

- The board consists of the following built-in parts:
01. Regulated power supply 0-5V at 30mA with coarse and fine voltage variation.
 02. IC Regulated power supply, 0-30V at 100 mA .
 03. Digital DC voltmeter with selectable switch range 0 - 2/20V.
 04. Digital DC voltmeter ranges 0-200 V DC.
 05. Digital DC Ammeter with selectable switch range 0-2/20 mA.
 06. Digital DC Ammeter with selectable switch range 0-20/200 mA.
 07. Power Transistor
 08. Adequate no. of other electronic components.
 09. Mains ON/OFF Switch and Fuse.
 - * The Unit is operative on 230 \pm 10% at 50 Hz.
 - * Adequate no. of patch cords stackable 4mm spring loaded plug length 1/2 metre.
 - * Good Quality, reliable terminal/sockets are provided at appropriate places on panel for connections/ observation of waveforms.
 - * Strongly supported by detailed Operating Instructions, giving details of Object Theory, Design procedures, Report Suggestions and Book References.

Other Apparatus Required:

01. Cathode Ray Oscilloscope 20 MHz.
02. Function Generator

D.C. Step Down Mosfet Chopper

Order Code - 46562



Looking to the recent requirement of educational institutions, we have developed 46562. D.C. Step down mosfet chopper.

Practical experience on this board carries great educative value for Science and Engineering Students.

Object:

To study D.C. Step down Mosfet Chopper.

Features:

The board consists of the following built-in parts:

01. \pm 12 Volt D.C. at 100mA, regulated Power Supply.
02. 20 Volt DC at 1A, regulated Power Supply.
03. IC for triangular pulse generation.
04. IC to drive MOSFET.
05. MOSFET.
06. Two potentiometer for varying frequency and duty cycle.
07. Adequate no. of other Electronic Components.
08. Mains ON/OFF switch and Neon Jewel light for indication.
- * The unit is operative on 230V \pm 10% at 50Hz A.C. Mains.
- * Adequate no. of patch cords stackable from rear both ends 4mm spring loaded plug length 1/2 metre.
- * Good Quality, reliable terminal/sockets are provided at appropriate places on panel for connections/ observation of waveforms.
- * Strongly supported by detailed Operating Instructions, giving details of Object, Theory, Design procedures, Report Suggestions and Book References.

Other Apparatus Required:

01. Dual Trace Cathode Ray Oscilloscope 20MHz (Unearthed).

D.C. To A.C. Inverter (Input 12V DC 80AH Output 230VAC, 40W)

Order Code - 46563



Power Electronic Training Board has been designed specifically for the study of working of inverter. A Battery 12V 80AH(Any car battery) is required to operate this apparatus. Different test points have been provided to check waveshape and amplitude of pulses how DC supply is changed to AC supply.

Practical experience on this board carries great educative value for Science and Engineering Students.

Object:

To study the multivibrator circuit to convert DC to AC .

Features:

The board consists of the following built-in parts:

01. IC-1 & IC-2 to generate AC signals to drive
 02. 12-0-12VAC at 4 Amp. Transformer.
 03. Four NPN low Power Transistors.
 04. Four NPN high Power Transistors
 05. Red, Black and Green terminals for test points.
 06. Lamp holder and Lamp 40W, 230V.
 07. Unit is operative on 12 volt 80AH Battery (Any Car Battery).
 08. Sufficient quantity of patch cords.
- * Good Quality, reliable terminal/sockets are provided at appropriate places on panel for connections/ observation of waveforms.
 - * Strongly supported by detailed Operating Instructions, giving details of Object, Theory, Design procedures, Report Suggestions and Book References.

Other Apparatus Required:

01. Battery 12V DC 80AH (Any Car Battery).
02. Digital Multimeter - Order Code 16901
03. Dual Trace Cathode Ray Oscilloscope 20MHz (Unearthed).

Step Up & Step Down Transistor Chopper

Order Code - 46564



To study Step Up & Step Down Chopper. Practical experience on the board carries great educative value for Science and Engineering Students.

Object:

To study Step Up & Step Down Transistor Chopper..

Feature:

The board consists of the following built in parts :

01. +12V DC at 1.5 Amp, IC Regulated Power Supply internally connected.
 02. -12V DC at 200 mA, IC Regulated Power Supply internally connected.
 03. IC for Triangular wave pulse generation.
 04. OPamplifier.
 05. Choke 40mH.
 06. Lamp 230V 15watt.
 07. DC Motor 12 V.
 08. Adequate no. of other Electronic Components.
 09. Mains ON/OFF switch, Fuse & Jewel light.
- * The unit is operative on 230V \pm 10% at 50Hz AC
 - * Adequate no. of patch cords stackable from rear both ends 4mm spring loaded plug length 1/2 metre.
 - * Good Quality, reliable terminal/sockets are provided at appropriate places on panel for connections/observation of waveforms.

Other Apparatus Required:

01. Dual Channel Cathode Ray Oscilloscope 20MHz.

To Study and Plot V/ I Characteristic of Power IGBT (insulated Gate Bipolar Transistor)

Order Code - 46565

To study & Plot VI Characteristic of Power IGBT. The board is absolutely self contained.

Practical experience on this board carries great educative value for Science and Engineering Students.

Object:

01. To study and Plot V/I Characteristic of a Power IGBT.
02. Switching characteristic of a power IGBT

Features:

The board consists of the following built-in parts:

01. IC regulated power supply 0-10V DC at 30mA.
 02. IC regulated power supply 0-60V at 200mA.
 03. Digital DC voltmeter range 0-20V
 04. Digital DC voltmeter range 0-200V.
 05. Digital DC Ammeter with selectable switch range 0-20/200mA.
 06. One IGBT.
 07. Adequate nos. of other electronic components.
 08. Mains ON/OFF switch & Fuse.
 09. The unit is operative on 230V \pm 10% at 50Hz AC
- * Adequate no. of patch cords stackable from rear both ends 4mm spring loaded plug length 1/2 metre.
 - * Good Quality, reliable terminal/sockets are provided at appropriate places on panel for connections/ observation of waveforms.
 - * Strongly supported by detailed Operating Instructions, giving details of Object, Theory, Design procedures, Report Suggestions and Book References.

Other Apparatus Required:

01. Dual Trace Cathode Ray Oscilloscope 20MHz.
02. Function generator

Stepper Motor Control Using IC SAA-1027

Order Code - 46566



Stepper Motor Control trainer are based on IC SAA-1027 & designed to study the various functions of a stepper motor. It can be interfaced with microprocessor trainer and personal computer.

Practical experience on this board carries great educative value for Science and Engineering Students.

Object:

To study various functions of Stepper Motor

Features:

The board consists of the following built-in parts:

01. DC Stepper Motor 4 winding torque 1.0 Kg-cm, step angle 1.8°, power 12V 0.2 Amp/ phase
02. Fast & slow selection switch
03. Forward & reverse selection switch
04. Free run & step selection switch
05. Microprocessor/ PC and on board selector switch built in option for microprocessor interfacing/

- personal computer
06. IC regulated 12V DC at 500mA
 07. Timer IC LM 555
 08. Driver IC SAA-1027
 09. Adequate nos. of other electronic components.
 10. Mains ON/OFF switch, fuse & jewel light.
 11. The unit is operative on 230V $\pm 10\%$ at 50Hz AC
- * Good Quality, reliable connector are provided at appropriate places on panel for connections to microprocessor/PC and terminals to connect external counter.
 - * Strongly supported by detailed Operating Instructions, giving details of Object, Theory, Design procedures, Report Suggestions and Book References.

Study of Buck Boost Principle

Order Code - 46567



Study of buck boost principle has been designed with a view to provide practical/experimental knowledge of Automatic two step Buck Boost Principle with electronically controlled circuit. All the components and test points of the Principle are spread on the panel at appropriate places. A diagram is neatly drawn on the panel.

Practical experience on this board carries great educative value for Science and Engineering Students.

Object:

01. To demonstrate the Buck Boost principle.
02. To demonstrate the lower voltage setting.
03. To demonstrate the upper voltage setting.
04. To demonstrate automatic voltage stabilization of A.C. Voltage.

Features:

01. The unit consists of Automatic two step Buck-Boost Principle with electronically controlled circuit.
02. Strongly supported by detailed Operating Instructions, giving details of Object, Theory, Design procedures, Report Suggestions and Book References.

Specifications:

- * Input voltage : 180-270 Volt AC
- * Output voltage : 200-240 Volt AC
- * Frequency : 50 Hz
- * Output Current : 1.1 Amp.
- * Capacity : 250 Watt

Other Apparatus Required:

01. Variac 0-270 V, 2 Amp.

Study of Current Transformer (C.T.)

Order Code - 46568



Power Electronic Training Board has been designed specifically to study Current Transformer (C.T.). Practical experience on this board carries great educative value for Science and Engineering Students.

Object:

To study Current Transformer.(C.T.)

Feature:

The board consists of the following built-in parts:

01. Current Transformer INPUT current is 2 Amp & OUTPUT current 200 mA i.e. Ratio 10 : 1.
 02. Digital AC Ammeter 3 1/2 digits seven segment display having range 0-2A.
 03. Digital AC Ammeter 3 1/2 digits seven segment display having range 0-200mA.
 04. Three 100 W Bulbs have been provided for load. Controlled by three different switches.
 05. Adequate no. of other electronic components.
 06. Mains ON/OFF Switch and Fuse 1.5 amp.
- * The unit is operative on 230 V at 50Hz A.C. Mains.
 - * Adequate no. of patch cords stackable 4mm spring loaded plug length 1/2 metre.
 - * Good Quality, reliable terminal/sockets are provided at appropriate places on panel for connections/ observation of waveforms.
 - * Strongly supported by detailed Operating Instructions, giving details of Object, Theory, Design Procedures, Report Suggestions and Book References.

Other Apparatus Required:

01. VARIAC INPUT 230 VAC OUTPUT 0-270 VA.C. at 2 Amps.

Study of Potential Transformer (P.T.)

Order Code - 46569



Power Electronic Training Board has been designed specifically to study Potential Transformer (P.T.) Practical experience on this board carries great educative value for Science and Engineering Students.

Object:

To study Potential Transformer (P.T.)

Feature:

The board consists of the following built-in parts:

01. Potential Transformer is designed for 300 VAC INPUT & OUTPUT 30 VAC i.e. ratio 10 : 1.
 02. Digital AC voltmeter 0-1000V.
 03. Digital AC voltmeter 0-200V.
 04. Mains ON/OFF Switch and Fuse 100 mA.
- * The unit is operative on 230 V at 50Hz A.C. Mains.
 - * Adequate no. of patch cords stackable 4mm spring loaded plug length 1/2 metre.
 - * Good Quality, reliable terminal/sockets are provided at appropriate places on panel for connections/ observation of waveforms.
 - * Strongly supported by detailed Operating Instructions, giving details of Object, Theory, Design Procedures, Report Suggestions and Book References.

Other Apparatus Required:

- VARIAC INPUT 230 V OUTPUT 0-270 Volt at 2 Amps.

Study of Instrument Transformers (C.T & P.T.)

Order Code - 46570



Power Electronic Training Board has been designed specifically to study the working and application of instrument transformer. Measurement of power using Current and Potential Transformers. The setup consists of current Transformer, Potential Transformer, Ammeter, Voltmeter, Watt meter, Variac and Actual Load.

Practical experience on this setup carries great educative value for Science and Engineering Students.

Object:

To study an instrument transformers.

- Current Transformer (C.T.)
- Potential Transformer (P.T.)
- To connect instrument transformers (C.T. & P.T.) in electrical circuits for measurement of current, voltage and power.

Feature:

The board consist of following built in parts :

- Current Transformer (CT) ratio 1 : 10.
- Potential Transformer (PT) ratio 10 : 1.
- Two digital AC voltmeter 3½ digit seven segment display. To read 1000V ac and 200V ac.
- Two digital AC ammeter 3½ digit seven segment display. To read amp. ac and 200mA ac.
- Digital low power factor watt meter single phase single element two wire normal input 230 V (0 - 120%) of normal input current (0 - 0.5 Amp) (0 - 125%)
- Actual load 300Watt (Three 100 Watt Bulbs and Three switches)
- The unit operate 230V ±10% at 50 Hz AC Mains.
- Mains ON/OFF Switch and Fuse 2 Amp.
- * The Unit is operative on 230 ±10% at 50 Hz AC Mains.
- * Adequate no. of patch cords stackable 4mm spring loaded plug length 1/2 metre.
- * Good Quality, reliable terminal/sockets are provided at appropriate places on panel for connections/ observation of waveforms.
- * Strongly supported by detailed Operating Instructions, giving details of Object, Theory, Design Procedures, Report Suggestions and Book References.

Other Apparatus:

- Variac INPUT 230 V OUTPUT 0-270 Volt at 2 Amps.

R.M.S. and Average Values of Rectified Voltage

Order Code - 46571

Power Electronic Training Board has been designed specifically to use a Bridge Rectifier for full wave rectification of sinusoidal ac supply and to determine the relation between r.m.s. and average values of

rectified voltage.

Practical experience on this board carries great educative value for Science and Engineering Students.

Object:

- To connect a Bridge Rectifier for full wave rectification.
- To measure amplitude of the input and output voltage of Bridge Rectifier with help of CRO.
- To verify the relation between r.m.s. and average values of rectified O/P voltage.
- To verify that Moving Iron Type read r.m.s. value and Permanent Magnet Moving Coil Type Instrument read average values of an alternating voltage or current.

Feature:

The board consists of the following built-in parts:

- Bridge Type Silicon Rectifier
- Moving Iron Voltmeter 0-50 VAC/DC.
- Moving Coil Voltmeter 0-50 V DC.
- Transformers having five tapping of different voltages COM - 10 - 15 - 20 - 25 - 30 V at 0.3Amps.
- Three Resistances of high wattage as a load (100E/20W, 250E/10W, 500E/5W)
- Mains ON/OFF Switch, Fuse and Jewel light
- * The Unit is operative on 230 ±10% at 50 Hz AC Mains.
- * Adequate no. of patch cords stackable 4mm spring loaded plug length 1/2 metre.
- * Good Quality, reliable terminal/sockets are provided at appropriate places on panel for connections/ observation of waveforms.
- * Strongly supported by detailed Operating Instructions, giving details of Object Theory, Design procedures, Report Suggestions and Book References.

Other Apparatus Required:

- Cathode Ray Oscilloscope 20 Mhz.

Determination of Fusing Characteristics and Fusing Factor of Given Fuse

Order Code - 46572

Power Electronic Training Board has been designed specifically to determine the fusing characteristics and fusing factor of a given fuse.

Practical experience on this board carries great educative value for Science and Engineering Students.

Object:

- To draw a graph between fusing time and fusing current of a given fuse.
- To determine the fusing factor.
- To verify that fuses have inverse time characteristics.

Feature:

The experimental set-up consists of the following :

- One Inbuilt variac of input 230 VAC and output of 0 to 270 V at 2 Amp.
- Digital meter to read 20/200 Amp AC.
- Fuse wire : 1. Copper
- Tinned copper
- Digital Stop Clock : With START/STOP operation by means of toggle switch & RESET by a push button switch. It has a range of 999.9

seconds with resolution of 0.1 seconds and accuracy of $\pm 0.01\%$ (Quartz controlled). Display is thorough 4 no's of 12.5mm bright Seven Segment Displays and working voltage of the unit is $230V \pm 10\%$ 50Hz.

- 06. Transformer output : 2.25 V at 200 Amp.
- 07. Mains ON/OFF Switch, Fuse and Jewel light.
- * The Unit is operative on $230 \pm 10\%$ at 50 Hz AC Mains.
- * Good Quality, reliable terminal/sockets are provided at appropriate places on panel for connections/ observation of waveforms.
- * Weight : 14Kg. (Approx.)
- * Dimension : W 412 x H 150 x D 310

Single Phase HalfWave & Bridge Controlled Rectifier

Order Code - 46573



Power Electronic Training Board has been designed specifically to single phase half wave & bridge controlled rectifier. Practical experience on this board carries great educative value for Science and Engineering Students.

Object:

- 01. To study the single phase half wave controlled rectifier & observe the effect of firing angle of wave form.
- 02. To study the bridge controlled rectifier & observe the effect of firing angle of wave form.

Features:

The board consists of the following built-in parts:

- 01. 230VA.C. Isolated Transformer, Power 50 watt.
- 02. 9V D.C. at 100mA Zener Regulated Power Supply.
- 03. Two UJT.
- 04. Four SCR's.
- 05. Two Pulse transformer 1:1:1.
- 06. Two Potentiometers for controlling UJT firing angle.
- 07. Bulb 40W, 230VA.C.
- 08. Adequate no. of other Electronic Components.
- 09. Mains ON/OFF switch, Fuse and Jewel light.
- * The unit is operative on $230V \pm 10\%$ at 50Hz A.C. Mains.
- * Adequate no. of patch cords stackable 4 mm spring loaded plug length $\frac{1}{2}$ meter.
- * Good Quality, reliable terminal/sockets are provided at appropriate places on panel for connections/observation of waveforms.

Other Apparatus Required:

- 01. Dual Trace Cathode Ray Oscilloscope 20 MHz (Unearthed)//with Isolation Transformer for unearthing.

Home Electrical Wiring Training System

Order Code - 46578



Home Electrical Wiring Training System is a product which is helpful for students to get familiar with home wiring circuits. This

product provides a realistic training environment which is essential for every electrical engineering student and also for apprentice electrician.

It consists of Single Phase Energy Meter, MCB, Controlling Switches, Tube Light with Choke, Regulated Switch, Ceiling Fan, etc.

Good quality safe terminals and sockets are provided at appropriate places on board for power supply and load connections.

Features:

- 01. Easy diagrammatic representation of circuits
- 02. Energy Meter, Voltage and Current display on Graphical LCD (128x64)
- 03. Test points are provided to measure the voltages at different points
- 04. Designed after considering all safety standards
- 05. Low Cost Training System

Technical Specifications:

Supply Voltage : $230V AC \pm 10\%$, 50 Hz

Energy Meter Specifications

Meter Constant : 1600 impulses /KWh
 Display Counter : 100 impulses /Kwh (On LCD)
 Single Phase MCB : 6 A

Load specifications

Tube light : 20 Watt 220-240 V
 Ceiling Fan : 50 Watt 220-240 V
 Maximum Load Current : 4 Amp
 Measurement Display : Graphical LCD (128x64)

Experiments :

- 01. To study the connection /measurement of
- 02. Energy Meter and Consumer Unit
- 03. Voltage
- 04. Current
- 05. MCB wiring
- 06. Tube Light wiring
- 07. Two-Way Switch wiring
- 08. Short Circuit Fault
- 09. Switchboard
- 10. Ceiling Fan
- 11. Series-Parallel Operation on load

SCR Application Trainer

Order Code - 46579



SCR application trainer has been designed specifically for the study of SCR & Triac application. This training board gives better understanding of SCR, triac, UJT & Diac as used in various applications. Practical experience on this board carries great educative value for Science and Engineering Students.

Object:

To study the following D.C. Circuit Breaker

- 01. DC Circuit Breaker
 - To Study SCR Turn Off Action Under Varying Loads

- To Study DC Over Voltage Current Trip Action
- 02. Lamp Flasher
 - Symmetrical SCR Type DC Flasher
 - High Power AC Flasher
- 03. AC Phase Control
 - Half Wave Phase Control
 - Full Wave Phase Control
- 04. UJT Relaxation Oscillator
- 05. Thyristor Alarms
 - Study of Make-to-operate Alarms
 - Study of Break- To-operate Alarms
 - Demonstration of Temper-proof Burgler Alarm
- 06. Time Delay Relay
 - Study of Delayed Turn-'ON' of DC Load
 - Study of Auto Turn-'OFF' of DC Load
- 07. Light Activated Solid State Switch
- 08. Light Operated Switch/relay
- 09. To Demonstrate Lift Activated Relay
- 10. Temperature Controller
 - To Turn ON or OFF an External Load At A Particular Temperature
 - To Control And Maintain The Temperature of The Internal oven
- 11. Illumination Control Using Scr
- 12. Application of a Triac For Illumination Control
- 13. Study of An Electronic Timer Using IC NE 555
- 14. Scr Controlled Emergency Light

Features:

The board consists of the following built in parts :

- 01. Three I.C. regulated D.C. power supplies internally connected.
- 02. A.C. supply.
- 03. Isolation Transformer.
- 04. Timer I.C.
- 05. Operational amplifier I.C.
- 06. Quad dual Input NAND gate I.C.
- 08. Pulse Transformer.
- 09. Battery.
- 10. D.C. Relay.
- 11. OVEN with Power Supply.
- 12. Thermometer 0-110 °C.
- 13. Adequate no. of electronic components to be used in various experiments i.e. Pot 5 Nos., Push to on switch 2 Nos., Push to off switch, Buzzer, Bulb 230V40watt, Bulb 12V 5watt, LED 2Nos., Diode 4 Nos., Diac, Zener 2Nos., LDR, Thermistor, SCR 4 Nos., Triac, UJT 2 Nos, Transistors 3 Nos. Resistance & Capacitor 44No. etc. Main ON/OFF switch, fuse and jewel light.
- * The Unit is operative on 230V, ±10% at 50Hz A.C. mains.
- * Good quality, reliable terminals/Sockets are provided at appropriate places on panel for connections/observations.
- * Strongly supported by detailed Operating Instructions, giving details of Object, Theory, Design procedures, Report Suggestions and Book References.
- * Patch cords are provided to make required connections.

Synchronous Machine Training System

Order Code - 46580



Synchronous Machines are used as Generators in power plants because of their characteristic relation of speed with frequency. The study of power generators is the part of most of the curriculum. 46580 "Synchronous Machine Training System" is an exclusive product designed to demonstrate the fundamental concepts of parallel operation of Three Phase Synchronous Generators. This product is equipped with advanced measurement system for AC Parameters and DC Parameters. It has inbuilt which is highly stable and accurate. Due to use of big size LCD display it is possible to serve multiple parameters simultaneously. The RISC microcontroller based design provides better resolution and sensitivity as compared to analog meters. The panel is also equipped with advanced as Phase Sequence Indicator Digital Synchroscope Well as Conventional Lamps (Dark Lamp Method) to perform the synchronization of two generators. Students can learn the basics as well as advanced experiments and safety conditions with precautions that are encountered while generating power with multiple generators. Various terminals including three phase starter terminals are provided on front panel to provide flexibility and ease of connections while performing experiments. Students can perform experiments like Synchronization of parallel generators using advanced and conventional methods, behavior of generator, load sharing, power transfer parameters, analysis of voltage regulation of generator, V curve and inverse V curve in Three Phase Synchronous Generators with a vast flexibility.

Features:

- 01. Two Identical Motor Generator Set
- 02. Electrical Loading Arrangement
- 03. 240 X 128 Graphical LCD Display
- 04. RISC Microcontroller based design for measurement
- 05. High resolution ADC for accurate measurement
- 06. High sensitive to change in reading for better controlling
- 07. Inbuilt Digital Phase Sequence Indicator
- 08. Equipped with Synchroscope
Inbuilt Multifunction Meter for AC & DC Measurement
- 09. Lamps are provided on front panel for synchronisation
- 10. Designed considering all the safety standards
- 11. Provided with shaft protection cover
- 12. Equipped with supply indication lamps
- 13. Heavy Duty Base/Channel
- 14. Machine with Class "B" Insulation
- 15. Diagrammatic representation for the ease of connections
- 16. Learning material CD
- 17. 2 Year Warranty

Technical Specifications:

DC Power Supply

- Input mains : 230V AC ±10%, 50Hz
- Fixed DC output : 200V
- Variable DC output : 0-200V

AC Measurement Unit

- Voltage : ≥50 ≤500V
- Current : ≥0.2 ≤10A
- Power : ≥20 ≤2000W
- Power Factor : 0.99 Lead, Lag
- Frequency : ≥45 ≤55Hz

DC Measurement Unit
 Voltage : $\geq 25 \leq 500V$
 Current : $\geq 0.2 \leq 10A$
 Phase Sequence
 Indicator : For both generators
 Machines Specification

Both the M-G Sets are Flexibly Coupled and Mounted on a "C" channel Base DC Machine

Type : Shunt
 Voltage Rating : 200V
 Rating : 2HP
 Speed : 1500 RPM (no load)
 Insulation : Class "B"

Three Phase Synchronous Machine

Type : Salient Pole
 Rating : 3HP
 Voltage rating : 415V AC
 Speed : 1500 RPM (no load)
 Excitation Voltage : 120V
 Insulation : Class "B"
 Dimensions (mm) : W 930 x D 350 x H 675
 (Control Panel)
 W 250 x D 900 x H 400
 (MG Set)

Weight : 34kg (approx.)
 (Control Panel)
 212kg (approx.)
 (MG Set 2 Nos.)

Optional

01. DC Power Supply
02. Rheostat 2.8A, 220 ohms (4 Nos.)
03. Three Phase Resistive Load

Experiments:

01. Synchronization of two Three Phase Alternators by
 - Synchronoscope method
 - Three dark lamp method
 - Two bright one dark lamp method
02. Regulation of Three Phase Alternator by
 - Open Circuit test
 - Short Circuit test
03. Study & Analysis of V-Curve & Inverse V-Curve of Synchronous
04. Motor

DC Compound Motor Lab

Order Code - 46581



46581 DC Compound Motor Lab is an exclusive training system designed for Electrical laboratories to demonstrate the operation of DC compound motor. Students can understand the fundamental operating principle of DC Compound Motor. This product includes various experiments such as No Load Test, Load Test and Operating Characteristics of DC Compound Motor. The training system includes terminals for 4 point starters and rheostat so that these can be connected externally to the control panel.

Features:

01. Machine with mechanical loading arrangement

02. Provided with Digital Tachometer
03. Machine with Class "B" Insulation
04. Heavy Duty Base/Channel
05. Terminals provided to use the optional externally
06. Brake-Drum/Pulley with heat suppression facility
07. Designed by considering all the safety standards
08. Diagrammatic representation for the ease of connections
09. Exclusive and Compact Design
10. Learning material CD
11. 2 Year Warranty

Technical Specifications:

DC Power Supply

Input Mains : 230V AC $\pm 10\%$, 50Hz
 Fixed DC output : 200V
 Variable DC output : 0 -200V

Machines Specifications (2 Nos.)

Both the machines are flexibly coupled and mounted on "C" channel base DC Machine

Type : Compound
 Rating : 1HP
 (Also available with 2HP, 3HP & 5HP)

Voltage Rating : 200V
 Speed : 1500 RPM (No Load)
 Insulation : Class 'B'
 Loading Arrangement : Mechanical
 Brake Drum/Pulley : Aluminum Casted

Analog Meters used

DC Voltmeter (MC) : 300V (2 Nos.)
 DC Ammeter (MC) : 5A (2 Nos.), 2A
 Dimensions (mm) : W 600 x D 450 x H 600
 (Control Panel)
 W 335 x D 450 x H 560
 (motor)

Weight : 17kg (approx.)
 (Control Panel)
 40kg (approx.) (Motor)

Optional

01. DC Power Supply
02. (for machines rated upto 2HP/3HP/5HP respectively)
03. Software window shows working principle of DC
04. Machine 4 Point Starter

Experiments:

01. Study & verify the Load Characteristics of Short Shunt DC Compound Motor
02. Study & verify the Load Characteristics of Long Shunt DC Compound Motor

Power Measurement By Three Voltmeter & Three Ammeter Method

Order Code - 46582



46582 Power Measurement by three voltmeter 7 three Ammeter method is an exclusive and important product designed to explain students about the basic concepts of power measurement in electrical devices by three voltmeter and three Ammeter method. Using these

method students can calculate the power and power factor in case of non-availability of the wattmeter. This is a user product in which students can make connection and calculate the power by using test points provided. The panel is equipped with all necessary protection circuits to avoid fault.

Features:

01. Digital panel meters
02. Designed by considering all the safety precautions
03. Stand alone operation
04. Exclusive and rugged designed panel
05. Diagrammatic representation for ease of connections
06. Learning material CD
07. 2 Year Warranty

Technical Specifications:

- Mains supply : 230 V ± 10%, 50Hz
- Auxiliary supply : 230 V ± 10%, 50Hz
- Choke Coil : 300mH, 5A
- Voltmeter : 0-500V (3Nos.)
- Ammeter : 0-5A (3 Nos.)
- MCB : 5A
- Dimensions (mm) : W 450 x D350 x H 600

Optional :

01. Single phase Variac : 0-230V, 5A.
02. Rheostat : 45 W, 5A.

Experiments:

01. To calculate the power and power factor in a singlephase circuit using three voltmeters.
02. To calculate the power and power factor in a singlephase circuit using three Ammeters.

Three Phase Thyristorised AC Regular with Triggering Circuit

Order Code - 46583



46583 Power Electronic Training Board has been designed specifically for the study of Three Phase Thyristorized AC Regulator with Triggering Circuit. Practical experience on this board carries great educative value for Science and Engineering Students.

Object:

01. To study the nature and generation of Control Signal for 3 phase Thyristorized AC Regulator.
02. To study the operation of a 3 phase Thyristorized AC Regulator with R load.
03. To study the operation of a 3 phase Thyristorized AC Regulator. with R-L Load (Induction Motor.)

Features:

- The board consists of the following built-in parts:
01. Three Phase thyristorized AC Regulator.
 02. Three pole power contractor with /AC coil complete with Push-to-ON switch. /
 03. Four pole Miniature Circuit Breaker (MCB).
 04. Three separate identical cards consisting of Zero Crossing Detector, Integrator, Comparator and Pulse Generator one for each phase, for controlling the triggering angles of the positive group of three

thyristors. Another card in conjunction with above three cards for controlling the triggering angles of the negative group of three thyristors.

05. Firing angle control potentiometer.
06. Three 415: 100 Vat 1 Amp Transformer for rectification and 6VAC supply for Triggering.
07. ± 12V at 500mA, IC Regulator Power Supply for Triggering Circuits.
08. 5V at 500mA, IC Regulator Power Supply for Triggering Circuits.
09. Six nos. Driver Circuits with Pulse Transformers.
10. High Frequency Gated Dual Gate Firing 6 nos.
11. R Load
12. Digital AC Voltmeter 3 1/2 Digit Range 0-200V.
13. Digital AC Current Ammeter 3 1/2 Digit Range 0-2Amp.
14. Unearthed mains sockets for CRO.
15. Adequate no. of other Electronic Components.
16. Three Jewel light in red, Yellow and Blue Colour
17. The unit is operative on 3 Phase 415V at 50HzA.C. Mains.
18. Adequate no. of patch cords stackable 4 mm spring loaded plug length 50cm.
19. God Quality, reliable terminal/sockets are provided at appropriate places on panel for connections/ observation of waveforms.
20. Strongly supported by detailed Operating Instructions, giving details of Object, Theory, Design procedures, Report Suggestions and Book References.
21. Weight : 12 Kg. (Approx.)
22. Dimension : W 415 xH 165 xD 315 (mm)

List of Accessories:

01. Patch cord 4mm length 50cm Red & Black 22Nos.

Other Apparatus Required:

01. Dual trace CRO

Three Phase Transformer Lab

Order Code - 46584



46584 "Three Phase Transformer Lab" is an adaptable training system for the Electrical laboratories. The product helps understand basic concepts and functioning of a Three Phase Transformer. The product is represented in an easy way so that each test can be studied differently in proper sequence. Three Phase configurations such as Star-Star, Star-Delta, Delta-Star and Delta-Delta, Measurement of different losses and consequently determine efficiency and voltage regulation at any predetermined load etc.

Features:

01. Stand alone operation
02. Graphical LCD display for high resolution
03. Exclusive and rugged designed set-up
04. Electrical loading arrangement
05. Three Phase Supply indication lamps
06. Designed by considering all the safety precautions
07. Diagrammatic representation for the ease of connections
08. Exhaustive Learning Material

09. 2 Year Warranty

Technical Specifications:

Mains Supply : 415 V \pm 10%, 50Hz
Transformer Specifications
 Type : Three Phase
 Power Rating : 1KVA
 Primary Voltage : 415V
 Secondary Voltage : 230V
 Rated Current : 4Amp
 Graphical LCD display : 240 x 125 Pixel
 Dimensions (mm) : W600 x D350 x H600

Optional:

- 01. Three Phase Variac, 10Amps
- 02. Three Phase Resistive Load

Experiments:

- 01. Study of Three Phase Configurations
- 02. Study of Open Circuit Test in a Three Phase Transformer
- 03. Study of Short Circuit Test in a Three Phase Transformer
- 04. Study of Load Test and correspondingly determine the Efficiency and Voltage Regulation in a Three Phase Transformer

Electrical Transmission Line Trainer

Order Code - 46585



Transmission Line is the key learning concept for Electrical Engineers. Transmission Line Training System is exclusively designed to deliver the learning aspects of the electrical transmission line. Digital display is provided for easy measurement of Voltage, Current, Power, Power Factor, etc. These parameters help students to learn the characteristics of transmission line and calculations of the ABCD, H, Z parameters. Students can perform various experiments like short, medium and long transmission line and their behavior. Also one of the important experiment which can be performed with this training system is Ferranti Effect.

Features:

- 01. Voltage, Current, Power, Power Factor Measurement
- 02. Simultaneous display of sending & receiving end
- 03. Inbuilt Variable AC Supply
- 04. Big Graphical LCD
- 05. Exclusive and attractive designed panel
- 06. Stand alone operation
- 07. Designed by considering all safety precautions
- 08. Diagrammatic representation for ease of connections
- 09. Extensive Learning Material CD
- 10. 2 Year Warranty

Technical Specification:

Mains Supply : 230 V \pm 10%, 50 Hz
Single Phase Variac
 Input : 230 V
 Output : 0-270 V

Current : 0-5 Amp
Display Measurement
 Voltage : \geq 25 V
 Current : \geq 0.2 A
 Active Power : \geq 20 W [2000 W
 Reactive Power : \geq 20 VAR [2000 VAR
 Apparent Power : \geq 20 VA [2000 VA
Loads
 Resistor : 700 Ω / 100 W
 Inductor : 800 mH/ 0. 5A
 Capacitor : 12.5 μ F/ 450 V
 Dimension (mm) : W 824 x D 350 x H 624

Experiments:

- 01. To study Short Circuit, Medium, Long Transmission Line
- 02. Determine the ABCD, H, Z and Image parameters of Short Transmission Line
- 03. Determine the ABCD, H, Z and Image parameters of Medium Transmission Line For T network, For Pi network
- 04. Determine the ABCD, H, Z and Image parameters for Long Transmission Line
- 05. Measure the receiving end voltage of each line under no load or lightly load condition to understand Ferranti effect
- 06. Understand the performance of transmission line under different loads

Transmission Line Trainer

Order Code - 46585A



46585A Transmission Line Trainer is a rugged training system for the Electrical laboratories mounted on Aluminum profile rack with sturdy table top flat panel. Each panel has ABS molded plastic sturdy enclosure with 4mm shrouded connectors showing circuit diagram & its connection tag numbers for easy understanding and connections. The product helps you to get fully acquainted with the basic concepts and functioning of an Transmission Line Trainer.

Specifications:

- 01. Trainer having control panel should provided in 40X40mm Aluminum profile rack with sturdy table top flat panel.
- 02. Should have 8 no's of ABS plastic panel mounted on the aluminum rack with mimic diagram
 All input & output are terminated in 4mm shrouded connector, Should provide 4mm banana cable for experiments.
- 03. Should have 3phase DOL starter 4pole MCB, contractor & relay panel - 4 pole MCB of 415 V/4A.- DOL 9A Contactor with 230V / 50 Hz / 11VA COIL.- Bimetallic thermal O/L relay with range 1.4A - 2.3A
- 04. Should have 3 phase multifunction meter panel (2nos) . - Bidirectional Multifunction - 3 Phase $\frac{3}{4}$ wire, 415V, CT Input 5A - LCD/LED display, Aux supply 230V, 45-65 Hz, 5W - V, A, Hz, Pf, KVA, KW, KWH
- 05. Should have FWD/REV Switch panel. - FWD/REV,3

- pole 3 way switch, 6A/440V.
06. Should have Transmission Line Compensation panel.
 - 7 numbers of capacitors for cpmensation are 2,4,6,8,10 & 15uF.
 - 3 Pole 7 way Cam switch for selection
 07. Should have 3 Phase Resistive Load panel.
 - 10K/5K/3.5K/2.5K/2K/1.5K/OFF 200W Load.
 - 7 Way Selector switch for selection of load resistors
 08. Should have 3 Phase Inductive Load panel.
 - 0-0.75-3H Inductive Load.
 09. Should have 3 Phase Capacitive Load panel.
 - 0-2.5uf capacitive Load.
 10. Should have table top Simulated Transmission Line.
 - Short range Transmission line using RLC (10E,0.15H,2,2uF)
 - Medium range(125Km/200Km Transmission line Pie & T model.
 11. Should have table top Dimmer.
 - 3 phase dimmer input 415V, 50Hz
 - Output 0-450V/ 6A

Experiments:

01. Study of No Load Test.
02. Study of VAR compensation.
03. Study of Symmetry & un-symmetry faults in transmission line.
04. Determination of transmission line constants ABCD.
05. Study of flow of real & reactive power. Load test calculation of regulation, efficiency of transmission line.

Home Automation Electrical Wiring Trainer

Order Code - 46586

It is the basic training course tutor in electrical technology. The training system consists of various electrical components used in home automation and wiring technology. Provision to interconnect individual component with safe terminals on facia. Consists variety of Electrical Safety protection devices and up to moderate Video Door Phone and Interphone devices.

Features :

01. Demo of various tones/ functions like Dial, busy, ring tones & functions like Trunk dial, Redial, call receive, call pickup, call hold, call forward, call forward cancel, Automatic call back, call conference, call Transfer, Barge in & direct trunk access etc. 230VAC, 50VA mains operation
02. Shock proof safety Banana Terminals & patch cords for inter connections & operations
03. MS fabricated powder painted control panel
04. Poly carbonate/Venyl front facia with precision machined back support

Technical Specifications :

- * Two pole incoming mains switch socket with fuse protection and self illumination : 230VAC @ 6A
- * Short circuit Protector : 230VAC @ 6A
- * Earth leakage circuit breaker : 230VAC @ 100Ma earth fault / leakage current
- * Watt Hour Meter : Digital display of V, I, COS \hat{O} , KWHa & KWHR
- * Distribution module : L, N, E safety Terminals

- * Expansion Module : Provision to multiply the connection point
- * Mains outlet module : 230VAC @ 5A & 16A 2 pin socket - 1 no, 3 pin mains sockets - 2 nos & 3 pin power sockets - 2nos
- * House wiring : Rocker switch 4 nos , 2way switch : 2nos
- * Lamps and sockets : 15,40,60,100 Watts with 4 sockets, 1Ft Fluorescent Tubes : 1 no
- * Relay Module: Time delay Relay : programmable time delay 30/60Sec on delay 230Vac
- * Electric Heater: 1KW immersion coil, Induction/ Electric Pan: 1KW, Temp 250oc
- * Step down transformer : 15VAC @ 1A
- * Push buttons & Latching Switch : Push to on and Push to off
- * 6 way Selector switch: 230VAC @ 5A
- * Eye day light module : LDR/ Infra red day light switch with sensor, Sensitivity adjustment, LED annunciation & 1c/o Relay,
- * Fire, Smoke sensing module : Temp and smoke sensing with LED annunciation, Fire acknowledge and reset, 1contact
- * Gas leak sensing module : Gas sensing with sensor, Sensitivity adjustment, LED annunciation & 1c/o Relay,
- * Home door video : LCD color video door phone, hands free & door bell module
- * Interphone Module : 1 x 4 Intercom with RJ connectors on plug sockets, Pulse & Tone dialing, Cross point space division technology, 64 KEEPRAM, loop resistance : Extension- 600W, Co-line 1200W, Cross talk attenuation >70dBm
- * Buzzer : 1 No.

Electrical Home Installation Trainer

Order Code - 46586A



46586A Electrical Home Installation Trainer is a rugged training system for the Electrical laboratories mounted on Aluminum profile rack with sturdy table top flat panel. Each panel has ABS molded plastic sturdy enclosure with 4mm shrouded connectors showing circuit diagram & its connection tag numbers for easy understanding and connections. The product helps you to get fully acquainted with the basic concepts and functioning of an Electrical Machines & Generator.

Specifications:

- * Trainer having control panel should provided in 40X40mm Aluminum profile rack with sturdy table top flat panel.
- * Should have 12 no's of ABS plastic panel mounted on the aluminum rack with mimic diagram & one ACP panel.
- * All input & output are terminated in 4mm shrouded connector, Should provide 4mm banana cable for experiments.
- * Should have MCB, ELCB, Lamp mounted on ACP Panel
 - 1 Phase MCB 6A-nos, 16A-2nos.
 - ELCB with 1phase Power chord for supply with Indicator

- 20w Led Tube Light(2nos), 20W Led Panel Light, 10W Led Bulb, Mercury bulb, Incandescent Bulb, 230V operated Fan.
- * Should have Residential Switch panel-1.
 - Surface mount 2way 3terminal,10A
 - Surface mount 1way 2terminal,10A
 - Surface mount 1way 2terminal,10A illuminated
 - Surface mount marked "Bell"
 - Surface mount dimmer
 - Surface mount Push Button, 1N.O 1N.C
- * Should have Residential Switch panel-2.
 - Surface mount Cam Selector Switch ON/OFF (2nos)
 - Surface mount 2 way 4terminal Toggle Switch,10A(2nos)
- * Should have 1 Phase Socket panel-1.
 - 1Phase Socket with switch,13A,3prong,1 gang
- * Should have 1 Phase Socket panel-2.
 - 1 Phase Socket with switch, 16A, 3 prong,1 gang.
- * Should have 1 Phase Socket panel-2.
 - 1 Phase Socket with switch, 16A, 1 gang.
- * Should have Bell/Buzzer panel.
 - 230V AC operated door bell.
 - 12V operated Buzzer.
 - 12V Door Lock
- * Should have Door Phone panel.
 - Door Phone Signaling with camera, Speaker, Mic.
 - 12V DC power supply output
- * Should have Door station panel.
 - Door station with camera, display, Speaker, Mic.
- * Should have Intercom panel.
 - 3 extension intercom system.
- * Should have Telephone panel. (2nos)
 - 1 telephone system.
- * Should have Multifunction meter panel.
 - 1 Phase Meter to measure V, A, KWH. Hz

Experiments:

01. Study of components in Home electrical items provided.
02. Study of connection for Door bell, Lamp, Fan.
03. Study of connection for Buzzer. Door lock
04. Study of connection for Door station.
05. Study of connection for intercom system
06. Study for load measurement while connecting to home application.

Ward Leonard Method of DC Machine

Order Code - 46587



46587 Ward Leonard Method of DC Machine is an elite training system for Electrical Laboratories. The product helps you to get fully acquainted with the basic concepts and functioning of a DC machines. The product demonstrates the Ward-Leonard Method of DC Machine through which user can not only operate but also control the speed of DC Machine in either direction without using DC supply. Separate terminals of Armature and Field windings are brought out on a terminal box fitted on top of the Motor so that one can connect them separately to the panel and can perform experiment correspondingly.

Reverse connecting Switch is provided to control the speed of DC Motor in either direction. The trainer thus provides explicit understanding of the subject. All protection devices are in built so there is almost no chance of fault or danger to user.

Technical Specifications:

Input mains Supply : Three Phase
415V, ±10%, 50Hz

Machines Specification (2 Nos.)

Both the Machines are flexibly coupled and mounted on a M.S. channel base acts as a Motor Generator set.

AC Three Phase Squirrel Cage Induction Motor acts as a Prime Mover

Rating : 1 HP
Voltage Rating : 415 V
RPM : 1440 (No Load)
Insulation : Class 'B'

DC Shunt Motor

Rating : 1 HP
Voltage Rating : 200 V
RPM : 1500 (No Load)
Insulation : Class 'B'

Extra D.C. Shunt Motor 200 V for which the speed can be Controlled using Motor Generator set.

Rating : 1/2 HP
Voltage Rating : 200 V
RPM : 1500 (No Load)
Insulation : Class 'B'

Meters used

Voltmeter (MC) : 1 Nos.
Ammeter (MC) : 2 Nos.
Dimensions (mm) : W 450 X D 600 X H 450
Weight : Control panel : 19.50 Kg.
Motor : 60 Kg.
Optional Item : Three Phase Variac

Experiments:

01. To study the speed control of Separately Excited DC Shunt Motor in either direction by Ward Leonard Method.

DC Supply

Order Code - 46588



46588 DC Supply is used in electrical engineering laboratories for the purpose of conducting experiments in DC Machines and Circuits. This product provides 200V Fixed and Variable DC output for continuous operation with an over current protection. Output voltage and current can be continuously monitored by front panel meters.

The main power assembly consists of a thyristor bridge circuit which rectifies the incoming AC supply to produce a Fixed DC supply. Rectified voltage can be varied by altering the firing angle of the thyristors thereby providing Variable DC Output to the DC Machines

Features:

01. Over Current protection
02. Field failure protection

03. Suitable to run in series and shunt mode of machine
04. Low cost thyristor based design
05. Separate section for Fixed and Variable Supply
06. Easy to handle
07. Provided with supply indication lamp
08. Learning material CD
09. 2 Year Warranty

Technical Specifications:

Input Mains	: 230V AC \pm 10%, 50Hz
DC Output Voltage	
Fixed	: 200V, 3A
Variable	: 0-200V, 12A
Analog Voltmeter	: 300V
Analog Ammeter	: 15A
Single Phase MCB	: 16A
Dimensions (mm)	: W 450 x D 250 x H 340
Weight	: 9kg (approximate)

RLC Resonance Trainer

Order Code - 46589



46589 RLC Resonance Trainer is unique product that provides a complete learning content for both Series and Parallel Resonance. Resonance is an interesting phenomenon in electrical circuits in which Inductive and Capacitive elements behave to make a Zero Impedance circuit. This explanation is given with the help of Passive circuits on the Trainer. Multiple combination of components has been provided so that students can calculate Resonance Frequencies for different combinations. Concept of Resonance Frequency is explained very clearly which can be easily seen either on Oscilloscope or on the board display.

Features:

01. LCD Voltmeter and Frequency Counter
02. Inbuilt Signal Generator
03. Low cost trainer demonstrating both Series and Parallel Resonance
04. Experiments can be performed with or without Oscilloscope
05. Inbuilt power supply
06. Extensive E-Manual
07. 2 Year Warranty

Technical Specifications:

Mains Supply	: 90 - 275 V, 50 / 60 Hz
Generator Output	: 8Vpp
Frequency Ranges	: 1 KHz, 10 KHz, 60 KHz
Voltmeter	: 2V

Experiments:

01. Study of Series R-L-C Resonance and to determine its Resonance Frequency.
02. Study of Parallel R-L-C Resonance and to determine its Resonance Frequency.

Three Phase Synchronous Motor Lab

Order Code - 46590



46590 Three Phase Synchronous Motor Lab is an adaptable Training System for the Electrical Laboratories. The product helps in getting fully acquainted with the basic concepts, functioning and operating principle of a Three Phase Synchronous Motor. The product includes experiment such as V and inverse V curve of synchronous motor. For engineering students it is important to know how the variation of field current can affect the power factor of the Synchronous Motor and hence improve the system's performance.

Separate terminals of windings brought out on a terminal box fitted on top of the motor so that one can connect them separately to the control panel and can perform experiment correspondingly. All protection circuits are in built. So there is very less chance of fault or danger to user. The varied scope of learning makes the subject easily understandable.

Features:

01. Flexible Shaft Coupling Arrangement
02. Centre-Tapped Wattmeter being used for better precision
03. Equipped with supply indication lamps
03. Provided with Digital Tachometer
04. Machine with Class "B" Insulation
05. Heavy Duty Base/Channel
06. Designed by considering all the safety standards
07. Diagrammatic representation for the ease of connections
08. Exclusive and Attractive Design
09. Learning material CD
10. 2 Year Warranty

Technical Specifications:

Mains Supply	: Three Phase, 415V \pm 10%, 50Hz
--------------	-------------------------------------

Machines Specification (2 Nos.)

Both the Machines are flexibly coupled and mounted on a M.S. Channel base

Three Phase Synchronous Motor

Type	: Salient Pole
Rating	: 3 HP
Voltage rating	: 415V \pm 10%
Speed	: 1500 RPM
Insulation	: Class 'B'
Excitation Voltage	: 120V

DC Machine (Acts as generator)

Type	: Shunt
Rating	: 2 HP
Voltage Rating	: 200V
Speed	: 1500 RPM (no load)
Insulation	: Class 'B'

Analog Meters Used

AC Ammeter (MI type)	: 10A
DC Ammeter (MC Type)	: 2A
AC Voltmeter (MI type)	: 500V
DC Voltmeter (MC Type)	: 300V
Wattmeter	: 1500 - 0- 1500W (2 Nos.)
MCB (TPN)	: 10A
Dimensions (mm)	: W 600 x D 450 x H 600 (Control Panel)

	: W 250 x D 900 x H 400 (MG Set)
Weight	: 18.5kg (approximate) (Control Panel)
	: 106kg (approximate) (MG Set)

Measurement of Xd and Xq of Three Phase Synchronous Machine

Order Code - 46591



46591 Measurement of Xd and Xq of Three Phase Synchronous Machine is an exclusive product designed to demonstrate the operating principle and functioning of Three Phase Synchronous Generator. This machine lab can change the mechanical energy to electrical energy. It helps students to analyse and calculate the significant parameters such as positive, negative & zero sequence impedance, direct & Quadrature axis reactance etc. To correctly construct Three Phase Synchronous Generator.

It includes separate terminals for rheostat and three point starter provided on the control set-up so that students can make connections by themselves with adequate protections.

Features:

01. Electrical Loading Arrangement
02. Flexible Shaft Coupling Arrangement
03. Provided with Digital Tachometer
04. Machine with Class "B" Insulation
05. Heavy Duty Base/Channel
06. Equipped with supply indication lamps
07. Terminals provided to use the optional externally
08. Equipped with supply indication lamps
09. Designed by considering all the safety standards
10. Diagrammatic representation for the ease of connections
11. Exclusive and Compact Design
12. Learning material CD
13. 2 Year Warranty

Technical Specifications:

Mains Supply : Three Phase, 415V±10 %, 50Hz

DC Power Supply

Input Mains : 230V AC, 50Hz

Fixed DC output : 200V

Variable DC output : 0 - 200V

Machines Specification (2 nos.)

Both the Machines are flexibly coupled and mounted on "C" channel base

DC Machine

Type : Shunt
 Rating : 2HP
 Voltage Rating : 200V
 Speed : 1500 RPM (no load)
 Insulation : Class "B"

Three Phase Synchronous Machine

Type : Star Connected
 Voltage Rating : 415V
 Rating : 3HP
 Speed : 1500 RPM (no load)
 Excitation Voltage : 120V
 Insulation : Class "B"

Analog Meters used

DC Voltmeter : 300V
 DC Ammeter : 10A
 AC Voltmeter : 500V, 20V

AC Ammeter : 10A, 2A
 MCB (TPN) : 10A
 Dimensions (mm) : W 600 x D 450 x H 600 (Control Panel)
 W 250 x D 900 x H 400 (MG set)
 Weight : 17.5kg (approx.) (Control Panel)
 106kg (approx.) (MG Set)

Optional:

01. DC Power Supply (for machines rated upto 2HP/3HP respectively)
02. Rheostat 2.8A, 220V
03. Three Phase Variac, 10A

Experiments:

01. Study and Measurement of Direct Axis (Xd) and Quadrature Axis (Xq) Reactance by Slip Test
02. Study and Measurement of Positive Sequence Impedance of Three Phase Synchronous Generator
03. Study and Measurement of Negative Sequence Impedance of Three Phase Synchronous Generator
04. Study and Measurement of Zero Sequence Impedance of Three Phase Synchronous Generator

Three Phase Synchronous Generator Lab

Order Code - 46592



46592 Three Phase Synchronous Generator Lab is an exclusive & important product designed to provide comprehensive learning about fundamental concepts and operating principles of Three Phase Synchronous Generator. Synchronous Generators are the primary source of electrical energy. These are used to convert mechanical power derived from (steam, gas, or hydraulic) turbine to ac electric power. The product provides hands-on experiments like Open Circuit Characteristic of Synchronous Generator and study of the relation between field current and armature voltage.

The product is very easy to use. All protection circuits are in built so there is very less chance of fault or danger to user. The varied scope of learning makes the subject's understanding complete.

Features:

01. Electrical Loading Arrangement
02. Flexible Shaft Coupling Arrangement
03. Provided with Digital Tachometer
04. Machine with Class "B" Insulation
05. Heavy Duty Base/Channel
06. Equipped with supply indication lamps
07. Terminals provided to use the optional externally
08. Equipped with supply indication lamps
09. Designed by considering all the safety standards
10. Diagrammatic representation for the ease of connections
11. Exclusive and Compact Design
12. Learning material CD
13. 2 Year Warranty

Technical Specifications:

DC Power Supply

Input Mains : 230V AC, 50Hz
 Fixed DC output : 200V
 Variable DC output : 0 - 200V

Machines Specification (2 Nos.)

Both the Machines are Flexibly Coupled and Mounted on a M.S. channel Base

DC Machine (acts as Prime Mover)

Type : Shunt
 Rating : 2HP
 Voltage Rating : 200V
 Speed : 1500 RPM (no load)
 Insulation : Class 'B'

Three Phase Synchronous Motor (acts as Generator)

Type : Salient Pole
 Rating : 3HP
 Voltage rating : 415V ±10%
 Speed : 1500 RPM (no load)
 Insulation : Class 'B'
 Excitation Voltage : 120V
 Analog Meters Used
 DC Voltmeter (MC) : 300V
 DC Ammeter (MC) : 10A, 1A
 AC Ammeter (MI) : 10A
 AC Voltmeter (MI) : 500V (2 Nos.)
 Dimensions (mm) : W 600 x D 450 x H 600
 (Control Panel)
 W 250 x D 900 x H 400
 (MG set)

Weight : 17.5kg (approximate)
 (Control Panel)
 106kg (approximate)
 (MG Set)

Optional:

01. DC Power Supply
02. Rheostat 2.8A, 220W

Experiments:

01. To study the Open Circuit Characteristics (OCC) of Three Phase Synchronous Generator
02. To study the short circuit characteristics (SCC) of three Phase Synchronous Generator

Induction Motor Compound Generator Lab

Order Code - 46593



46593 Induction Motor Compound Generator Lab is an adaptive training system for Electrical laboratories. It is designed to demonstrate the fundamental concepts of DC Compound Generator on different loading conditions. The diagrammatic representation is provided on the control panel so that students can make connections themselves. All protection circuits are inbuilt, so there is very less chance of fault or danger.

Features:

01. Electrical loading arrangement
02. Flexible shaft coupling arrangement

03. Provided with Digital Tachometer
04. Machine with Class "B" Insulation
05. Heavy Duty Base/Channel
06. Equipped with supply indication lamps
07. Designed by considering all the safety standards
08. Diagrammatic representation for the ease of connections
09. Exclusive and Compact Design
10. Learning material CD
11. 2 Year Warranty

Technical Specifications:

Mains Supply : Three Phase, 415V±10%, 50Hz

Machine Specifications

Both the Machines are flexibly coupled and mounted on a 'C' Channel base

Three Phase Induction Motor (acts as prime mover)

Type : Squirrel Cage
 Rating : 2HP
 Voltage Rating : 415V AC
 Speed : 1440 RPM (no load)
 Insulation : Class 'B'

DC Machine (acts as generator)

Type : Compound
 Rating : 1HP (also available with 2HP & 3HP)
 Speed : 1500 RPM (no load)
 Insulation : Class 'B'

Analog Meters used

DC Voltmeter (MC) : 300V (2 Nos.)
 DC Ammeter (MC) : 5A (2 Nos.)
 AC Voltmeter (MI) : 500V
 AC Ammeter (MI) : 5A
 MCB (TPN) : 10A
 Dimensions (mm) : W 600 x D 450 x H 600
 (Control Panel)
 W 180 x D 900 x H 285 (MG set)
 Weight : 17kg (approx.) (Control Panel)
 55kg (approx.) (MG Set)

Optional:

01. Three Phase Variac 10A
02. Resistive Load (for machines rated upto 1HP/ 3HP respectively)

Experiments:

01. Study and verify the Load Characteristics of Long Shunt Cumulatively Compound Generator
02. Study and verify the Load Characteristics of Short Shunt Cumulatively Compound Generator
03. Study and verify the Load Characteristics of Long Shunt Differentially Compound Generator
04. Study and verify the Load Characteristics of Short Shunt Differentially Compound Generator

Three to Six Phase Conversion Trainer

Order Code - 46594



46594 Three to Six Phase Conversion Trainer is a comprehensive training product used to illustrate the core concepts of Electrical Engineering. With this product, user can learn of how Three Phase Supply can

be converted into Six Phase with proper phase shift by using three Single Phase Transformers. Separate terminals are provided to analyze Six Phase waveform using Single Phase as a reference waveform. The product familiarizes with the phenomenon of Polarity usually expressed as a round dot. User can also get to know the significance of Three Phase Parameters and verify the Star and Delta connection properties.

Features:

01. Separate terminals to analysis waveforms
02. Three Identical Single Phase Transformer
03. Equipped with supply indication lamps
04. Equipped with bulb holder to use load
05. Designed by considering all the safety standards
06. Diagrammatic representation for the ease of connections
07. Exclusive and Attractive Design
08. Learning material CD
09. 2 Year Warranty

Technical Specifications:

Mains supply : Three Phase, 415V ±10%, 50Hz

Transformers Specification (3 Nos.)

Primary Winding : 0 - 230V
 Secondary Winding : 30 - 0 - 30V

Analog Meters Used

Voltmeter (MI) : 300V
 Ammeter (MI) : 1A
 MCB (TPN) : 10A
 Dimensions (mm) : W 600 x D 350 x H 450
 Weight : 18kg (approx.)

Optional:

Three Phase Variac
 Oscilloscope

Experiments:

01. Study of Polarity Test under Single Phase Transformer | Study of Three Phase Parameters of Three Phase Supply
02. Study of Three to Six Phase Conversion using 3 nos. Single Phase Transformers

Shunt Motor Series Generator Lab

Order Code - 46595



46595 Shunt Motor Series Generator Lab is an elite training system for the Electrical laboratories. This product help students to understand basic operations of DC Series Generator. It can aptly be used for performing various experiments like Working of Generator, Analysis of Magnetic Characteristic and also efficiency at any desired load.

Separate terminals of armature and field windings are provided on top of the machine. Starter and rheostat terminals are provided on the panel so that these can be connected externally to the circuit. The product thus provides complete understanding of experiments with Shunt Motor and Series Generator.

Experiments:

01. Specially designed BS-10 safety terminals
02. Electrical loading arrangement
03. Designed by considering all safety precautions
04. Diagrammatic representation
05. Learning material CD
06. 2 Year Warranty

Technical Specifications:

DC Power Supply

Input Mains : 230V AC ±10%, 50Hz
 Fixed DC output : 200V
 Variable DC output : 0-200V

Machine Specifications

Both the Machines are flexibly coupled and mounted on a "C" Channel base

DC Motor (acts as prime mover)

Type : Shunt
 Rating : 1HP
 Voltage Rating : 200V
 Speed : 1500 RPM (no load)
 Insulation : Class 'B'

DC Generator

Type : Series
 Rating : 1HP (Also available with 2HP & 3HP)
 Speed : 1500 RPM (no load)
 Insulation : Class B

Meters used

DC Voltmeter (MC) : 300V (2 Nos.)
 DC Ammeter (MC) : 5A (2 Nos.), 1A
 Dimensions (mm) : W 600 x D 450 x H 600 (Control Panel)
 W 180 x D 900 x H 310 (MG set)
 Weight : 17kg (approx.) (Control Panel)
 53kg (approx.) (MG Set)

Optional:

01. DC Power Supply (for machines rated upto 2HP/3HP/5HP respectively)
02. Resistive Load (for machines rated upto 1HP/ 3HP respectively)
03. 3 Point Starter
04. Rheostat 5A,110W

Experiments:

01. Study and verify the No-Load Characteristic of DC Series Generator
02. Study and verify the Load Characteristic of DC Series Generator

Field Test of DC Series Machine

Order Code - 46596



46596 Field Test of DC Series Machine is an elite training system for the Electrical laboratories. DC Machines are an important part of Electrical Engineering Syllabus and to let students understand the basic operation of DC Series Generator, this product play a vital role. It can aptly be employed for performing various exercises like Generator's Working,

analysis Magnetic Characteristic, calculate efficiency of both Motor and Generator at any desired load can be predetermined in a easiest manner.

Separate terminals of armature and field windings brought out on a terminal box fitted on top of the Motor. The training system includes terminals for Rheostat and Starter so that devices can be connected externally to the panel. The product thus provides explicit understanding of the subject.

Features:

- 01. Stand alone operation
- 02. High Quality meters
- 03. Mechanical coupling arrangement
- 04. Standard BS-10 safety terminals
- 05. Electrical loading arrangement
- 06. Designed by considering all the safety precautions
- 07. Diagrammatic representation for the ease of connections
- 08. Learning material CD
- 09. 2 Year Warranty

Technical Specifications:

DC Power Supply

Input Mains : 230V AC ±10%, 50Hz

DC Power Supply

Fixed : 180 - 200V

Variable : 0 - 180/200V

(Please refer specifications on the motor)

Machine Specifications

Both the Machines are flexibly Coupled and Mounted on a "C" channel Base

DC Series Machines (2 Nos.)

Rating : 1HP (Also available with 5HP)

Speed : 1500 rpm (at load)

Insulation : Class "B"

Meters used

DC Voltmeter (MC) : 3 Nos.

DC Ammeter (MC) : 2 Nos.

Dimensions (mm) : W 600 x D 350 x H 600

Experiments:

- 01. To study and verify the field test of DC Series Motor and determine the efficiency of DC Series Motor and Generator

DC Series Motor Shunt Generator Lab

Order Code - 46597



46597 DC Series Motor Shunt Generator Lab is an adaptable training system for electrical Machines laboratories designed to explain the operational working and characteristic of DC Shunt Generator at different loading conditions. A shunt generator is a method of generating DC output by paralleled connection of field and armature windings and possesses inverse characteristic between load current and terminal voltage. 46597 provides comprehensive learning details to demonstrate various exercises like working operation of DC Shunt Generator, no load and load characteristics etc. All connections and appearance are designed in such a manner so that it will look user friendly. Diagrammatic representations are

provided on the control set-up so that students can make connections by their own. All protection circuits are in built so there is very less chance of fault or danger.

Features:

- 01. Provided with digital Tachometer
- 02. Electrical Loading arrangement
- 03. Shaft coupling arrangement
- 04. Good quality meters
- 05. Designed by considering all the safety standards
- 06. Specially designed patch cords for safety purpose
- 07. Diagrammatic representation for the ease of connections
- 08. Exclusive & Compact design
- 09. Learning material CD
- 10. 2 Year Warranty

Technical Specifications:

DC Mains : 200V

Machines Specifications

Both the M-G Set are Flexibly Coupled and Mounted on a "C" channel Base

DC Machine (acts as prime mover)

Type : DC Series

Rating : 1HP

Current : 4.1A

RPM : 1500

Insulation : "B"

DC Machine (acts as Generator)

Type : DC Shunt

Rating : 1HP

Current : 4.1A

Generated Voltage : 180V ±10%

RPM : 1500 (No Load)

Insulation : "B"

Meters used

DC Voltmeter (MC) : 300V (2 Nos.)

DC Ammeter (MC) : 5A (2 Nos.)

DC Ammeter (MC) : 1A

Dimensions (mm) : W 600 x D 350 x H 450

Weight

Panel : 12.5kg (approx.)

MG set : 54kg (approx.)

Optional :

- 01. DC Supply
- 02. 220Ohms, 2A Rheostat
- 03. Resistive Load for 1 HP DC Generator

Experiments:

- 01. Study and Measurement of Open Circuit Characteristic of DC Shunt Generator
- 02. Study and Measurement of Internal characteristic of DC Shunt Generator
- 03. Study and Measurement of External characteristic of DC Shunt Generator

Understanding Calibration of Energy meter

Order Code - 46598



46598 Understanding Calibration of Energy Meter is designed to deliver the practical knowledge of measurement of electricity consumption in real world. Today electricity is a vital element for human society. The rapid growth in electric appliance usage has contributed to an explosive growth in electrification around the world. To use electricity better, it is required to have a deep knowledge of Electricity measurements. 46598 provides indepth knowledge of Energy meter measurements and its calibration using Voltmeter, Ammeter and Watt meter.

It has two displays, one is Standard meter and another is Energy meter. The onboard LCD display works as Standard meter for calibration of Energy meter and display value of Voltage, Current and Watt. The Energy meter display provides energy consumption details. The facility to connect external Watt meter or Voltmeter and Ammeter is also provided.

Features:

01. Single phase kWh Energy meter
02. Inbuilt Voltmeter, Ammeter, Watt meter as Standard meter for calibration of Energy meter
03. Big font LCD (16 x 2) for use as Standard meter/ Energy meter calibration
04. Separate Seven Segment Display as Energy meter
05. Digital Calibration/ Operation using Keypad
06. Sockets are provided to Connect External Voltmeter, Ammeter and Watt meter for Calibration
07. Default and User Calibration modes are provided to avoid errors during Operation
08. 5 LED Operation Indicators
09. Learning material CD
10. 2 Year Warranty

Technical Specifications:

Auxiliary Power Supply	: 90 - 270V ±10%, 50Hz
Standard meter	
Voltmeter Mini/Max	: 10/300V
Ammeter Mini /Max	: 0.1/5A
Watt meter Mini/Max	: 10/1500W
Energy meter Display	
Resolution	: 0.001kWh
Frequency	: 50Hz
Fuse	: 250mA (2 Nos.) 5A (4 Nos.)
Dimension (mm)	: W 350 x D 280 x H 55

Options:

01. 7025B Watt Meter, Voltmeter and Ammeter Module
02. AC/DC Load

Experiments:

01. Study the connection of Voltmeter, Ammeter & Watt meter for Power measurement of load in Transmission line
02. Study the connection of Energy meter in Transmission line
03. Measurement of Energy in kWh
04. Calibration of Energy meter using inbuilt Watt meter
05. Calibration of Energy meter using inbuilt Voltmeter & Ammeter
06. Calibration of Energy meter using Analog Watt meter
07. Calibration of Energy meter using Analog Voltmeter & Ammeter
08. Experiments on effect of wrong Calibration on

Energy meter

Induction Motor Series Generator Lab

Order Code - 46599



46599 Induction Motor Series Generator Lab is a training system designed to provide comprehensive learning and functioning of a DC Series Generator. It can be used for performing various experiments like Operating Characteristics, Terminal Voltage v/s Armature current (V-I) Characteristics and Load Characteristics, etc. All protection circuits are inbuilt, so there is very less chance of fault or danger.

Features:

01. Electrical Loading Arrangement
02. Flexible shaft coupling arrangement
03. Provided with Digital Tachometer
04. Machine with Class "B" Insulation
05. Heavy Duty Base/Channel
06. Equipped with supply indication lamps
07. Designed by considering all the safety standards
08. Diagrammatic representation for the ease of connections
09. Exclusive and Compact Design
10. Learning material CD
11. 2 Year Warranty

Technical Specifications:

Mains Supply	: Three Phase, 415V ±10 %, 50Hz
--------------	---------------------------------

Machine Specifications

Both the Machines are flexibly coupled and mounted on a 'C' Channel base

Three Phase Induction Motor (acts as prime mover)

Type	: Squirrel Cage
Rating	: 2HP
Voltage Rating	: 415V AC
Speed	: 1440 RPM (no load)
Insulation	: Class 'B'

DC Machine (acts as generator)

Type	: Compound
Rating	: 1HP (also available with 2HP & 3HP)
Speed	: 1500 RPM (no load)
Insulation	: Class 'B'

Analog Meters used

DC Voltmeter (MC)	: 300V (2 Nos.)
DC Ammeter (MC)	: 5A (2 Nos.)
AC Voltmeter (MI)	: 500V
AC Ammeter (MI)	: 5A
MCB (TPN)	: 10A
Dimensions (mm)	: W 600 x D 450 x H 600 (Control Panel) W 170 x D 900 x H 285 (MG set)

Weight	: 17kg (approx.) (Control Panel) 53kg (approx.) (MG Set)
--------	---

Optional:

- 01. Three Phase Variac, 10A
- 02. Rheostat 5A, 110W
- 03. Resistive Load
(for machines rated upto 1HP/3HP respectively)

Experiments:

- 01. Study & verify No-Load Characteristics of DC Series Generator
- 02. Study & verify Load Characteristics of DC Series Generator

Compound Motor Compound Generator Lab

Order Code - 46600



46600 Compound Motor Compound Generator Lab is a useful training system for Electrical laboratories that provides comprehensive learning of DC Compound Generator. It can be employed for performing various experiments like Generator Working, Operating Characteristics, Terminal Voltage and Load Current (V-I) Characteristics, etc. Students can make connections easily.

Features:

- 01. Electrical loading arrangement
- 02. Flexible shaft coupling arrangement
- 03. Provided with Digital Tachometer
- 04. Machine with Class "B" Insulation
- 05. Heavy Duty Base/Channel
- 06. Terminals provided to use the optional externally
- 07. Equipped with supply indication lamps
- 08. Designed by considering all the safety standards
- 09. Diagrammatic representation for the ease of connections
- 10. Exclusive and Compact Design
- 11. Learning material CD
- 12. 2 Year Warranty

Technical Specifications:

DC Power Supply

- Input Mains : 230V AC \pm 10%, 50Hz
- Fixed DC output : 200V
- Variable DC output : 0-200V

Machines Specification

Both the Machines are flexibly coupled and Mounted on a 'C' channel Base

DC Machine (acts as prime mover)

- Type : Compound
- Rating : 1HP
- Voltage Rating : 200V
- Speed : 1500 RPM
- Insulation : Class 'B'

DC Machine (acts as generator)

- Type : Compound
- Rating : 1HP (Also available with 2HP & 3HP)
- Speed : 1500 RPM
- Insulation : Class 'B'

Analog Meters used

- DC Voltmeter (MC) : 300V (3 Nos.)

- DC Ammeter (MC) : 5A (3 Nos.)
- Dimensions (mm) : W 600 x D 450 x H 600
(Control Panel)
W 180 x D 450 x H 600
(MG set)
- Weight : 17kg (approximate)
(Control Panel)
53kg (approximate) (MG set)

Optional:

- 01. DC Power Supply
(for machines rated upto 2HP/3HP/5HP respectively)
- 02. Resistive Load
(for machines rated upto 1HP/ 3HP respectively)
- 03. Rheostat 5A, 110W
- 04. 4 Point Starter

Experiments:

- 01. Study and verify the Load Characteristics of Long Shunt Cumulatively Compound Generator
- 02. Study and verify the Load Characteristics of Short Shunt Cumulatively Compound Generator
- 03. Study and verify the Load Characteristics of Long Shunt Differentially Compound Generator
- 04. Study and verify the Load Characteristics of Short Shunt Differentially Compound Generator

Slip Ring Induction Motor Lab

Order Code - 46601



46601 Slip Ring Induction Motor Lab is an important product designed to demonstrate the operating behavior & working of Three Phase Machine. It provides complete learning contents to enhance practical knowledge and makes students get to know the fundamental concepts of Three Phase Induction Machine.

The product includes comprehensive learning of various experiments such as running & reversing phenomenon, no load test, block rotor test and load test of Three Phase Induction Machine. Students can measure the equivalent circuit parameters along with losses, power factor under different loading conditions. Winding terminals brought out on top of the motor with adequate protections so that the students can make connections by themselves.

Features:

- 01. Machine with Mechanical Loading Arrangement
- 02. Provided with Digital Tachometer
- 03. Machine with Class "B" Insulation
- 04. Heavy Duty Base/Channel
- 05. Brake-Drum/Pulley with heat suppression facility
- 06. Equipped with supply indication lamps
- 07. Terminals provided to use the optional externally
- 08. Designed by considering all the safety standards
- 09. Diagrammatic representation for the ease of connections
- 10. Exclusive and Compact Design
- 11. Learning material CD
- 12. 2 Year Warranty

Technical Specifications:

Mains Supply : Three Phase, 415V ±10%, 50Hz

Three Phase Machine

Type : Slip-Ring
 Rating : 3HP (also available with 5HP)
 Voltage Rating : 415V
 RPM : 1440 (No load)
 Insulation : Class 'B'
 Loading Arrangement : Mechanical
 Brakedrum/Pulley : Aluminum Casted
 Meters Used
 Ammeter (MI) : 10A
 Voltmeter (MI) : 500V
 Wattmeter : 2500W (2 nos.)
 MCB (TPN) : 10A
 Dimensions (mm) : W 600 x D 350 x H 450 (Control Panel)
 W 430 x D 500 X H 760 (Motor)
 Weight : 14.5kg (approximate) (Control Panel)
 : 55kg (approximate) (Motor)

Optional:

01. Rotor Resistance Starter
02. Three Phase Variac, 10A

Experiments:

01. Study of Running and Reversing of Three Phase Induction Motor
02. Study of No Load Test in a Three Phase Induction Motor
03. Study of Block Rotor Test in a Three Phase Induction Motor
04. Study and Measurement of Slip in a Three Phase Induction Motor
05. Study of Speed-Torque Characteristics of Three Phase Induction Motor

Swinburn's Test of DC Machine

Order Code - 46602



46602 Swinburn's Test of DC Machine is an important training system for Electrical Laboratories. It can be aptly employed for understanding the fundamental concepts and functioning of DC Motor. Swinburn's Test is the method through which losses are measured separately and efficiency at any desired load can be predetermined.

Separate terminals of armature and field windings brought out on a terminal box fitted on top of the Motor. The training system includes terminals for Rheostat and Starter so that devices can be connected externally to the panel. The product thus provides explicit understanding of the subject.

Features:

01. Machine with Mechanical Loading Arrangement
02. Provided with Digital Tachometer
03. Machine with Class "B" Insulation

04. Heavy Duty Base/Channel
05. Brake-Drum/Pulley with heat suppression facility
06. Equipped with supply indication lamps
07. Designed by considering all the safety standards
08. Diagrammatic representation for the ease of connections
09. Exclusive and Compact Design
10. Learning material CD
11. 2 Year Warranty

Technical Specifications:

DC Power Supply

Input Mains : 230V AC ±10%, 50Hz
 Fixed : 200V
 Variable : 0-200V

DC Machine Specification

Type : DC Shunt
 Rating : 1HP
 (also available with 2HP, 3HP & 5HP)
 Voltage Rating : 200V
 RPM : 1500 (no load)
 Insulation : Class 'B'
 Loading Arrangement : Mechanical
 Brakedrum/Pulley : Aluminum Casted

Meters used

Voltmeter : 300V
 Ammeter : 5A (2 nos.)
 Dimensions (mm) : W 600 x D 350 x H 450 (Control Panel)

W 335 x D 450 x H 560 (Motor)

Weight : 11kg (approx.) (Control Panel)
 : 40kg (approx.) (Motor)

Optional:

01. DC Power Supply (for machines rated upto 2HP/3HP/5HP respectively)

Experiment:

01. Study and Determine the losses of DC Machine and correspondingly calculate the efficiency of DC Machine by Swinburn's Test Method

Hopkinson's Test of DC Machine

Order Code - 46603



46603 Hopkinson's Test of DC Machine is an adaptable training system used for Electrical Laboratory. It is designed to demonstrate the fundamental concepts and also facilitates easy learning about the various losses of DC Machine. Two similar machines are required to carry out Hopkinson's Test. Electrically these two machines are connected in parallel to determine the Efficiency of DC Machine by separately calculating the losses.

Separate terminals of Armature and Field windings are brought out on a terminal box fitted on top of the motor. The training system includes terminals for Rheostat and Starters so that these devices can be connected externally to the panel.

46603 has been designed in such an easy way that users can observe the voltages and current of windings of both the motors. All protection devices are in built negligible chance of fault or danger.

Features:

01. Exclusive and Compact Design
02. Electrical Loading Arrangement
03. Flexible Shaft Coupling Arrangement
04. Provided with Digital Tachometer
05. Machine with Class "B" Insulation
06. Heavy Duty Base/Channel
07. Terminals provided to use the optional externally
08. Designed by considering all the safety standards
09. Diagrammatic representation for the ease of connections
10. Learning material CD
11. 2 Year Warranty

Technical Specifications:

DC Power Supply

Input mains : 230V AC \pm 10%, 50Hz
 Fixed : 200V
 Variable : 0-200V

DC Machines Specification (2 Nos.)

Both the Machines are flexibly coupled and mounted on a M.S. channel Base acts as a Motor Generator set

Type : DC Shunt
 Rating : 1HP

(Also available with 2HP & 3HP)

Voltage Rating : 200V
 RPM : 1500 (no load)
 Insulation : Class 'B'

Meters used

Voltmeter (MC) : 300V
 Ammeter (MC) : 1A, 5A (2 nos. each)
 Dimensions (mm) : W 600 x D 450 x H 600 (Control Panel)
 W 180 x D 900 x H 310 (MG set)

Weight : 17kg (approx.) (Control Panel)
 53kg (approx.) (MG set)

Optional:

01. DC Power Supply
02. Rheostat 5A, 110 ohms (2 Nos.)
 (For machine rated upto 2HP/ 3HP respectively)

Experiment:

01. Study and obtain the losses separately and correspondingly. Determine the efficiency of a DC Shunt Machine by Hopkinson's test

Cut Section of Machines

Order Code - 46604



46604 Cut Section of Machines is an important part for all Electrical laboratories. Study of these machines is integral part of any educational course in Engineering. Student can easily understand various parts and operation of these machines with the help of these

running cut section.

A comprehensive Cut Section of all types of Machines is designed to explain the working principle behind the major Machines parts. With this, students are able to see clearly the major component of the Machines and how they are interconnected, both electrically and mechanically which helps them in enhancing their knowledge.

Features:

01. Self-Contained
02. Easy to operate
03. Quality designed motor with running condition
04. Easily distinguish the internal part of machines
05. Provided with terminal box for ease of connection
06. Learning material CD
07. 2 Year Warranty

Technical Specifications:

Model Nos.	Rating	Type of Machines
46604	1 HP	DC Shunt
46604A	1 HP	DC Compound
46604B	3 HP	3-Phase AC Synchronous
46604C	1 HP	3-Phase AC Squirrel Cage Induction
46604D	1HP	3-Phase AC Slip Ring Induction
46604E	1 HP	DC Series
46604F	1HP	1-Phase Capacitor Start Capacitor Run Induction motor
Weight	:	27kg (approximate)

Optional:

01. DC Supply
02. Single Phase Variac
03. Three Phase Variac

Experiments:

01. Identification of different part of Machines
02. Understanding the functional structure of Machine

Single Phase Bridge Converter Drive

Order Code - 46605



46605 Single Phase Bridge Converter Drive is an Elite Training System for Power Electronic Lab to demonstrate the operational functioning of Single Phase Bridge Converter. It includes experiment such as speed control of DC Motor by using full wave SCR configuration. It helps students to know how to generate firing pulses for single phase converter using ramp comparator scheme.

46605 is equipped with SCR firing control circuit that deals with triggering, modulation and instrumentation which derives the operating characteristics and capabilities of Converter. It incorporates all the necessary test points in order to explain the gate circuit by analyzing gate waveforms at different blocks through inbuilt Power Scope. Separate terminals of armature and field winding are provided to operate the machine in either of the excitation mode.

Features:

01. Power Scope for isolation measurement
02. Provided with DC Shunt Motor
03. High quality meters
04. Three Phase low voltage Supply for gate circuit
05. Three Phase Firing Circuit provided with pulse isolation
06. Test terminals provided to analyze the waveforms
07. Designed by considering all the safety precautions
08. Diagrammatic representation of circuits
09. Learning material CD
10. 2 Year Warranty

Technical Specifications:

Mains Supply : 230V ±10%, 50Hz

Motor Specification

Type : DC Shunt Motor
 Rating : 0.5HP
 RPM : 1500
 Power Scope : Isolated 1500Vmax
 SCR Rating : SCR TYN616, 600V/16A
 Diode Rating : 6A10, 1000V/6A
 Firing Angle Control : 30° to 180°

Analog Meter

DC Voltmeter : 300V
 DC Ammeter : 5A
 Single Phase MCB : 2A (SPN)
 Dimensions (mm) : W 600 x D 450 x H 600 (panel)
 W 180 x D 350 x H 310 (motor)

Weight

Panel : 18kg (approximate)
 Motor : 23kg (approximate)

Experiments:

01. Study of Ramp Comparator Firing Circuit for Drive
02. Study of Single Phase Bridge Converter Drive

Three Phase AC Voltage Controller

Order Code - 46606



46606 Three Phase AC Voltage Controller is a useful Training System for Power Electronics Lab to demonstrate the operational working of Three Phase AC Voltage Controller with different loading conditions. It includes the experiment such as speed control of Three Phase AC Motor through anti-parallel SCR configurations with fine control response. It helps students to know how to generate firing pulses for three phase converter using ramp comparator scheme. 46606 is equipped with SCR firing control circuit that deals with triggering, modulation and instrumentation deriving the operating characteristics and capabilities of Converter. It incorporates all the necessary test points in order to explain the gate circuit by analyzing gate waveforms through inbuilt Power Scope.

Features:

01. Power Scope for isolation measurement
02. Provided with Three Phase Motor
03. High quality meters

04. Three Phase low voltage Supply for gate circuit
05. Three Phase Firing Circuit provided with pulse isolation
06. Test terminals provided to analyze the waveforms
07. Designed by considering all the safety precautions
08. Diagrammatic representation of circuits
09. Learning material CD
10. 2 Year Warranty

Technical Specifications:

3 Phase Mains Supply : 415V ±10%, 50Hz

Three Phase Machine

Type : Squirrel Cage Induction Motor
 Rated Power : 1HP
 Rated Voltage : 415V
 Power Scope : Isolated 1500Vmax
 SCR Rating : SCR TYN616, 600V/16A
 Firing Angle Control : 30° to 150°

Meters Used

Analog AC Voltmeter : 0-500V
 Analog AC Ammeter : 0-5A
 Three Phase MCB : 5A (TPN)

Dimensions (mm)

Panel : W 600 x D 450 x H 600
 Motor : W 180 x D 350 x H 310

Weight

Panel : 18kg (approximate)
 Motor : 23kg (approximate)

Experiments:

01. Study of Three Phase Firing Circuit
02. Study of Three Phase AC Voltage Controller at Lamp Load
03. Study of Three Phase AC Voltage Controller at Motor Load

Power Measurement using CT & PT

Order Code - 46607



46607 Power Measurement using CT and PT setup is designed to explore the measurement techniques used in electrical meters for measurement of Voltage, Current, Power etc. Current Transformer (CT) and Potential Transformer (PT) are used to sense Current and Voltage respectively from a transmission line. The various parameters that affect the Current and Voltage sensing using CT and PT are primary and secondary winding turns, gauge of wire and type of core. 46607 provides indepth explanation and experimental analysis of various configurations of Current and Voltage measurement using CT and PT.

The students can measure the Voltage, Current, Wattage and Power Factor. Digital Voltmeter, Ammeter and Wattmeter are provided on panel to increase accuracy of measurement. The meters have very high accuracy and resolution.

The CT is provided on panel so that students can change the turns in primary winding and measure the corresponding changes in secondary winding and

Change in measurement. Protection circuit is inbuilt.

Features:

01. High resolution and accurate meters
02. Digital Voltmeter, Ammeter and Wattmeter
03. Internal variable power source
04. Real time appearance of CT with facility to change primary turns
05. Provided with all the accessories including rheostat to perform experiment
06. Designed by considering all the safety precautions
07. Learning material CD
08. 2 Year Warranty

Technical Specifications:

Mains Supply	: 230V ±10%, 50Hz
Variac	
Input	: 230V AC
Output	: 0-270V AC
Current Rating	: 5A
Ammeter (2 nos.)	
Display Resolution	: 0.01AAC
Range Min/Max	: 0.1/5A
Voltmeter (2 nos.)	
Display Resolution	: 1V AC
Range Min/Max	: 10V/300V
Wattmeter	
Display Resolution	: 1W
Range Min/Max	: 15/1500W
Current Transformer	
CT Ratio	: 1:10
Secondary Current Rating	: 2A
Potential Transformer	
PT1	
Primary	: 230V
Secondary	: 115V
PT Ratio	: 1:2
PT2	
Primary	: 230V
Secondary	: 57.5V
PT Ratio	: 1:4
Rheostat	: 220W, 2.8A
MCB	: 2A (SPN)
Dimensions (mm)	: W 600 x D 350 x H 450
Weight	: 22kg (approx.)

Experiments:

01. To measure high value of AC Current by a low range AC Ammeter and Current Transformer
02. To measure high value of AC Voltage by a low range AC Voltmeter and Potential Transformer
03. To measure Power using CT & PT
04. To study the effect of CT turns ratio in Current measurement
05. To study PT & CT connection in an electric Circuit for Measurement 3 Turn & 5 Turn.
06. Students can configure primary winding of CT to understand & analyse effect on secondary winding

Meter Demonstrator

Order Code - 46608



46608 "Meter Demonstrator" is all in one, training product designed for the students to make them familiar with the variety of analog measuring instrument & their principle. Variable AC & DC supply is provided to observe the response of each type of analog meter.

In modern world of electrical & electronics, it is required to measure many network parameters like current, voltage, energy and power. The analog measuring instruments are broadly classified in three classes: Moving coil, Moving iron & Dynamometer type. The aim of designing the product is to demonstrate the working of all types of analog measuring instruments.

Features:

01. Demonstration of Analog measuring instruments
02. CBT software covering all the experiments
03. Follows all safety standards
04. e-Manual
05. 2 Year Warranty

Technical Specifications:

Inbuilt Variable AC Supply	: 0 to 230V
Inbuilt Variable DC Supply	: 0 to 6 V (with load)
Meters Used	
AC Voltmeter (MI)	: 0 to 300V
DC Voltmeter (MC)	: 0 to 10V
AC Ammeter (MI)	: 0 to 1A
DC Ammeter (MC)	: 0 to 1A
AC Wattmeter (Dynamometer)	: 0 to 500W
Mains Supply	: 230 V ± 10%, 50 Hz
Dimensions (in mm)	: W 450x D 600 x H 60

Experiments:

01. Study the operation of moving coil type instruments
02. Study the operation of moving iron type instruments
03. Study the operation of Dynamometer type instruments

Radial And Ring Main Distribution System

Order Code - 46609



46609 Radial and Ring Main Distribution System is specially designed to illustrate the working phenomenon of Distribution System configured as Radial and Ring Main Distribution System. Distribution System is the part of electric power system which connects the high voltage transmission networks to the low voltage consumer service points.

Distribution Systems should be designed in a way that Voltage variation at consumer terminals must be maintained with in ±5%.

46609 provides complete learning content to develop Ring and Radial Distribution System manually. The Voltage regulation is studied by performing experiments & comparison. It includes inbuilt DC Variable Supply with adequate protections, precise digital meters are used along with separate sections for Radial and Ring Main Distribution System so that students can understand the significance of these

systems in a proper sequence.

Features:

- 01. Digital 3 nos. DC Voltmeter & 3 nos. DC Ammeter for accurate measurement
- 02. Separate connection for Radial & Ring Main System
- 03. Inbuilt DC Variable Supply
- 04. Isolation Transformer is provided for safe operation
- 05. Exclusive and attractive designed panel
- 06. Provided with inbuilt lamp load holders
- 07. Diagrammatic representation for the ease of connections
- 08. Learning material CD
- 09. 2 Year Warranty

Technical Specifications:

Mains Supply	: 230V ± 10%V AC, 50Hz
Inbuilt Isolated DC Output Supply	
Rated Voltage	: 0 - 220V ± 10% (Variable)
Rated Current	: 2A
Transformer	
Rating	: 0.5kVA
Primary Voltage	: 230V
Secondary Voltage	: 150V
Variac	
Input	: 230V
Output	: 0-270V
Current	: 2A
Digital DC Voltmeter (3 Nos.)	
Range	: 20-500V
Display Resolution	: 1V
Digital DC Ammeter (3 Nos.)	
Range	: 0-5A
Display Resolution	: 0.01A
MCB	: 2A (SPN)
Dimensions (mm)	: W 824 x D 350 x H 624
Weight	: 42kg (approx.)

Experiments:

- 01. Study of Radial Distribution network
- 02. Study of Ring Main Distribution network

Power Distribution Trainer

Order Code - 46609A



46609A Power Distribution Trainer is a rugged training system for the Electrical laboratories mounted on Aluminum profile rack with sturdy table top flat panel. Each panel has ABS molded plastic sturdy enclosure with 4mm shrouded connectors showing circuit diagram & its connection tag numbers for easy understanding and connections. The product helps you to get fully acquainted with the basic concepts and functioning of an Power Distribution Trainer.

Specifications:

- * Trainer having control panel should provided in 40X40mm Aluminum profile rack with sturdy table top flat panel.
- * Should have 12 no's of ABS plastic panel mounted on the aluminum rack with mimic diagram
- * All input & output are terminated in 4mm shrouded

connector, Should provide 4mm banana cable for experiments.

- * Should have 3phase DOL starter 4pole MCB, contractor & relay panel
 - 4 pole MCB of 415 V/4A .
 - DOL 9A Contactor with 230V / 50 Hz / 11VA COIL
 - Bimetallic thermal O/L relay with range 1.4A - 2.3A
- * Should have 3 phase multifunction meter panel .
 - Bidirectional Multifunction
 - 3 Phase ¾ wire, 415V, CT Input 5A
 - LCD/LED display, Aux supply 230V, 45-65 Hz, 5W
 - V, A, Hz, Pf, KVA, KW, KWH
- * Should have Circuit Breaker panel-1
 - 1 Pole MCB 16A
 - 3 Pole MCB 32A
 - ELCB 3 phase
- * Should have Switch Panel.
 - Surface Mount 3 Pin Socket
 - Surface Mount 5 Pin Socket
 - Surface Mount 2 way 2 terminal Switch.(2nos)
- * Should have Bus Bar Panel.
 - 5 copper bus bar 0.25 inch x inchShould have Fuse Panel.
 - 3 numbers of protective Fuse Should have Industrial Socket Panel.
 - 1 Phase 3 terminal Socket, 16A
 - 3 Phase 5 terminals Socket, 16A
- * Should have Analog Meter Panel.
 - 0-500V AC Voltmeter
 - 0-5A Ammeter
- * Should have Circuit Breaker panel-2.
 - 3 Phase MCCB panel
 - 415V AC, 50Hz , 100A NFB
- * Should have KWH Meter Panel-1.
 - 1 Phase KWH meter.
- * Should have KWH Meter Panel-1.
 - 3 Phase KWH meter.
- * Should have Lamp Load panel.
 - 230V 3 numbers of 100w bulb with socket as a Load.
 - On/OFF toggle should be provided for each blb socket.

Experiment List:

- 01. Study of components in electrical system & their operation.
- 02. Study of contact logics with trip indication.
- 03. Study of DOL starter, Contractor.
- 04. Study of Earth Leakage

Single And Three Phase Resistive Load

Order Code - 46610



46610 Single and Three Phase Resistive Load is a high wattage resistance network suitable for loading Single Phase and Three Phase supplies and generators. The load banks are used to verify the performance of power sources. However real loads are unpredictable and random in value hence standard loads are used to

stimulate environment for testing power sources. It is designed in robust enclosure. It consists of three banks of switched resistive loads. These three banks can be used with Single Phase and Three Phase Systems. Each bank of resistors is electrically isolated and separate terminals for each phase are provided on panel through a star/delta switch. The user can switch between star and delta very easily. MCB's are used to change the resistance of the load. The resistive load is equipped with a cooling fan to reduce the temperature. The load is mounted on a trolley to provide facility of easy movement in laboratories.

Features:

01. Suitable for Single and Three Phase Operation
02. Star/Delta Switch for easy conversion
03. Suitable for both static & rotating machines
04. Five selectable load values on each bank
05. Suitable for balanced and unbalanced load Conditions
06. MCBs are used to switch values and provide protection at the same time Provided with cooling fan for heat suppression
07. Designed by considering all the safety standards
08. Equipped with Supply Indication Lamps
09. Provide with trolley for flexible movement
10. 2 Year Warranty

Technical Specifications:

Single Phase Operation

Voltage	: 240V AC ±10%, 50Hz
Current	: 15A
Power	: 3.5kW
Loading steps	: 15
MCBs	
Current rating	: 10A (SP)
No. of MCBs	: 15

Three Phase Star Operation

Voltage	: 415V AC ±10%, 50Hz
Current	: 5A (per Phase)
Power	: 3.5kW
Loading steps	: 5 (per Phase)
MCBs (acts as a switch)	: 10A (SP)

Three Phase Delta Operation

Voltage	: 415V AC ±10%, 50Hz
Current	: 15A (per Phase)
Power	: 10.5kW
Loading steps	: 5 (per Phase)
MCBs	
Current rating	: 10A (SP)
No. of MCBs	: 15
Auxiliary Supply for fan	: 230V AC, 50Hz
Star/Delta Switch	: 415V, 25A
MCB	: 16A (TPN)
Dimensions (mm)	: 460 W x 740 D x 590 H
Weight	: 45kg (approximately)
Included Accessories	: Learning Material, Patch Cords

Single Phase Resistive Load

Order Code - 46610A



46610A Single Phase Resistive Load is a high wattage resistance network suitable for loading Single Phase

supplies and generators. The load banks are used to verify the performance of power sources. However real loads are unpredictable and random in value hence standard loads are used to stimulate environment for testing power sources.

It is designed in robust enclosure. It consists resistive banks of switched resistive loads. Switches are used to change the resistance of the load. The resistive load is equipped with a cooling fan to reduce the temperature.

Features:

01. Suitable for single phase operation.
02. Suitable for both static & rotating machines of single phase.
03. Five selective load value are provided.
04. Switch are used to switch value & protection MCB are provided.
05. Provided with cooling fan for heat suppression.
06. Designed by considering all the safety standards.
07. Equipment with supply indication lamp.
08. 1 Year Warranty.

Technical Specification:

Voltage	: 240V AC ±10%, 50Hz
Current	: 5A
Power	: 1.2KW
Loading Steps	: 5
MCB	: 01 Nos
Dimension	: 18" x 8" x 10¼"

Single And Three Phase Inductive Load

Order Code - 46611



46611 Single and Three Phase Inductive Load is suitable for loading Single Phase and Three Phase supplies and generators. It consists of robust enclosure that contains three banks of switchable inductive loads. Two terminals for each phase are given which are externally accessible through an inbuilt star delta switch.

All banks of inductors are electrically isolated and separate terminals for each phase are provided on panel through a star/delta switch so that the students can connect as a star or delta load for three-phase circuits. Each bank has a set of switches to bring each inductor into the circuit. This allows students to study the effects of balanced or unbalanced inductive loads. MCB's are used to change the inductance of the load. Students can connect the loads to experiment circuits using specially designed patch cords on the enclosed front panel. The load is mounted on a trolley to provide facility of easy movement in laboratories.

Features:

01. Suitable for loading Single Phase and Three Phase supply
02. Suitable for both static & rotating machines
03. Star/ Delta switch provides easy switching
04. MCBs are used to switch values and provide protection at the same time
05. Heavy duty wheel for easy movement
06. Suitable for balanced and unbalanced loading

- conditions
- 07. Designed by considering all the safety precautions
- 08. 2 Year Warranty

Technical Specifications:

Single Phase Operation

- Voltage : 240V AC ±10%, 50Hz
- Current : 15A
- Power : 3.5KVAR
- Loading steps : 15
- MCBs
- Current rating : 10A (SP)
- No. of MCBs : 15 Nos.

Three Phase Star Operation

- Voltage : 415V AC ±10%, 50Hz
- Current : 5A (per Phase)
- Power : 3.5KVAR
- Loading steps : 5 (per Phase)
- MCBs (acts as a switch) : 10A (SP)

Three Phase Delta Operation

- Voltage : 415V AC ±10%, 50Hz
- Current : 15A (per Phase)
- Power : 10KVAR
- Loading steps : 5 (per Phase)
- MCBs : 10A (SP)
- Star/Delta Switch : 415V, 25A
- MCB : 16A (TPN)
- Dimensions (mm) : 580 W x 750 D x 600 H
- Weight : 140kg (approximate)

Single Phase Inductive Load

Order Code - 46611A



Voltage utilized in industry are of either Resistive, Inductive or Capacitive types these provide various types of power factor and the power system behaves accordingly.

Inductive load banks provide lagging power factor, these are made by core with the help of switches the Inductance is increased or decreased. These are used to simulate industrial loads which are mostly lagging in nature. This Model is the Industrial/Educational model suitable for demonstrating to students the complete know of the Basics, of Inductance measured, Study of Efficiency & Maintenance of these Loads packaged in small rating. Students can make connections of their own with the help of the terminations provided.

Features:

- 01. Suitable for single phase operation.
- 02. Suitable for both static & rotating machines of single phase.
- 03. Five selective load value are provided.
- 04. Switch are used to switch value & protection MCB are provided.
- 05. Designed by considering all the safety standards.
- 06. Equipment with supply indication lamp.
- 07. 1 Year Warranty.

Technical Specification:

- Voltage : 240V AC ±10%, 50Hz
- Current : 8.5A
- Power : 2KW

- Loading Steps : 5
- MCB : 01 Nos
- Dimension : 400mm x 300mm

Single Phase & Three Phase Capacitive Load

Order Code - 46612



46612 Single Phase & Three Phase Capacitive Load consists of three banks of switchable capacitors. These three banks can be used with Single Phase & Three Phase Systems. The load banks are used to verify the performance of power source. However real loads are unpredictable and random in value hence standard loads are used and this stimulates environment for testing power sources. The capacitive load bank provides a leading power factor.

46612 is provided with a star and delta switch which facilitates the switching between star and delta connections. The capacitors can be selected in different combinations with the help of MCBs on front panel. The load is mounted on a trolley to provide facility of movement in laboratories.

Features:

- 01. Suitable for Single and Three Phase Operation
- 02. Star/Delta switch for easy conversion
- 03. Ten selectable load values on each bank
- 04. Suitable for balanced and unbalanced load Conditions
- 05. MCBs are used to switch loads and provide protection at the same time
- 06. Provide with trolley for flexible movement
- 07. Equipped with Supply Indication Lamps
- 08. Designed by considering all the safety standards
- 09. 2 Year Warranty

Technical Specifications:

- MainsSupply : 230V AC ±10%, 50Hz (Single Phase)
- : 415V AC ±10%, 50Hz (Three Phase)
- Current : 4.6A each phase (in Star connection)
- : 13A each phase (in Delta connection)
- Star/Delta Switch : 415V, 32A
- MCB : 16A (Four Pole) 1 No. 10A (One Pole) 30 Nos.
- Dimensions (mm) : W 560 x D 350 x H 420
- Weight : 22kg (approximate)

Single Phase Capacitive Load

Order Code - 46612A



Voltage utilized in industry are of either Resistive, Inductive or Capacitive types these provide various

types of power factor and the power system behaves accordingly.

Capacitive load banks are used to provide leading power factor in any power system, normally all industrial units have lagging power factor & hence utilize capacitive load banks for getting leading power factor which compensates with the lagging power factor & makes the power system work near unity, this reduces the reactive power of the system improving the overall efficiency.

This Model is the Industrial/Educational model suitable for demonstrating to students the complete know of the Basics, Change of capacitance in steps, Study of Efficiency & Maintenance of these Loads packaged in small rating.

Features:

01. Suitable for single phase operation.
02. Suitable for both static & rotating machines of single phase.
03. Five selective load value are provided.
04. Switch are used to switch value & protection MCB are provided.
05. Designed by considering all the safety standards.
06. Equipment with supply indication lamp.
07. 1 Year Warranty.

Technical Specification:

Voltage	:	240V AC ±10%, 50Hz
Current	:	5A
Power	:	1.2KW
Loading Steps	:	5
MCB	:	01 Nos
Dimension	:	400mm x 300mm

3-Phase Parameter Measurement

Order Code - 46613



46613 is a high accuracy 3-phase electrical energy measurement device. It is designed to measure any 3-phase electrical system simultaneously without using individual meters. It is a compact table top unit which includes signal processing required to perform Voltage, Current, Frequency, Active Power, Reactive Power, Apparent Power and Power Factor Measurements. This product is suitable to measure active, reactive, and apparent energy in various 3- phase configurations such as WYE or DELTA services. It is Compatible with both 3-phase/3-wire and 3-phase/4-wire systems. All the parameters measured are displayed simultaneously on a single display unit.

Features:

01. Microcontroller based design for accurate measurement
02. 240 x 128 Graphical LCD Display to view all the parameters
03. Simultaneous display of Three Phase electrical parameters
04. Used with Single Phase / Three Phase supply
05. 2 Year Warranty

Technical Specifications:

Measurement	:	
Connection Type	:	Input and Output
Input Voltage Range (Vr, Vy, Vb)	:	30 – 230 V r m s A C , Accuracy ±1%
Input Voltage Range (Vry, Vyb, Vbr)	:	50 – 450Vrms AC, Accuracy ±1%
Input Current Range (Ir, Iy, Ib)	:	0.20–10Amp, Accuracy ±1%
Frequency	:	45 – 55Hz, Accuracy ±0.5Hz
Active power	:	50 – 5000Watts, Accuracy ±2%
Reactive power	:	50 – 5000Watts, Accuracy ±2%
Apparent power	:	50 – 5000Watts, Accuracy ±2%
Auxiliary Supply	:	230V ±10%, 50Hz
Power Factor	:	0.30 to 0.99 both Lead and Lag, Accuracy ±2° Electrical

Transformer Oil Testing System

Order Code - 46614



46614 Transformer Oil Testing System is used for testing the dielectric strength of insulation oil used in Transformers.

Testing is performed to determine the reliability of the oil filled in Transformer. Transformer oil is used in all types of High Voltage Transformers & circuit breakers. This system includes motorized unit for smooth variation of high voltage.

Kilovoltmeter is provided for monitoring high voltage. This product also incorporates automatic tripping mechanism for protection against overload.

The equipment consists of two High Voltage Coils having starting winding at earth potential. The High Voltage Transformer is designed for testing Duty only.

Features:

01. Fully motorized high voltage control
02. Break down voltage protection
03. Over current protection
04. Mains & H.T. "ON" & "OFF" Switches
05. Incorporates automatic tripping mechanism
06. Mains and H.T. "ON" indications
07. Test cup with adjustable gap electrode arrangement
08. Equipped with Kilo Voltmeter
09. Designed by considering all the safety standards
10. Learning material CD
11. 2 Year Warranty

Technical Specifications:

Mains Supply	:	230V AC ±10%, 50Hz
Single Phase Variac	:	230V/ 0-270V
High Voltage Source	:	80kV, 20mA
HV Control Motor	:	

Type	: Servo
RPM	: 500 (No Load)
Voltmeter	: 0 to 100kV
Dimensions (mm)	: W 600 x D 350 x H 450
Weight	: 58kg (approximate)

Experiments:

01. Study & measurement of Breakdown Voltage (Dielectric Strength) of transformer oil

MCB And HRC Fuse Testing System

Order Code - 46616



46616 MCB (Miniature Circuit Breaker) and HRC (High Rupturing Current Capacity) Fuse Testing System is designed to explain the operating behavior and characteristics of MCB's and HRC fuse. It includes B type MCB, C type MCB and HRC fuse. These are protective devices capable of carrying currents under normal circuit conditions and automatically break the circuit whenever over load or short circuit condition occurs.

46616 provides complete learning contents to demonstrate the internal working of MCB's and HRC fuse. The MCB's are provided in transparent case to visualize the internal architectures. Two precise integrated circuit based Thermometers are provided on bimetal contact of MCB's to analyze the temperature rise and fall.

Digital timer is provided with start and stop facility to study the current versus tripping time characteristics. Inbuilt isolated variable AC Power Supply is provided for safety. The student will learn the difference in various classes of MCB's.

Features:

01. Alphanumeric 16X2 Big Font LCD for better visibility
02. Isolated Power Supply using Transformer
03. Inbuilt variable current injection facility
04. Transparent MCB's to understand internal architecture and its working
05. Inbuilt Timer, Current & Temperature on LCD
06. MCBs are mounted with temperature sensor for current temperature analysis
07. Equipped with supply indication lamp
08. Designed by considering all the safety standards
09. Diagrammatic representation for the ease of connections
10. Learning material CD
11. 2 Year Warranty

Technical Specifications:

Mains Supply	: 0-220V AC ±10%, 50Hz
Single Phase Variac	
Input	: 230V
Output	: 0-270V
Current	: 10A
Single Phase Transformer	
Rating	: 1kVA
Input	: 230V
Output	: 230V
Experimental Setup	

MCB's	: B type, 6A, C type, 2A
HRC Fuse	: 6A
Temperature Sensor (2 Nos.)	
Type	: Mounting type
Name	: LM35
Display Resolution	: 0.1°C
Mounting	: With Brass holder mounted on MCB's
Protective Devices	: 10A (SPN)
Rheostat	: 100W / 5A
Dimension (mm)	: W 600 x D 350 x H 450
Weight	: 22kg (approx.)

Experiments:

01. Study the operating characteristics of Miniature Circuit Breaker B-type 6A. Also draw the Current Time & Temperature-Time characteristics
02. Study the operating characteristics of Miniature Circuit Breaker C-type 2A. Also draw the Current Time & Temperature-Time characteristics
03. Study the operating characteristics of HRC fuse

Over Current Relay Testing System

Order Code - 46617



46617 Over Current Relay Testing System is a useful learning product for electrical laboratories. Over Current Relay monitors general balanced overloading and has current/time settings. These settings determine the protective schemes. The relay is IDMT type which has different tripping time characteristics with different current conditions. These are classified in accordance with their characteristic curves which indicate the speed of tripping operation. The typical settings for relay is 0.5-2 Amp in 1-10 seconds.

46617 has accurate voltage, current & time measurement. It includes built-in variable supply, digital voltmeter, ammeter, timer. The timer operation is automatic when current is applied to relay. This automatic operation ensures accurate tripping time measurement.

Features:

01. Alphanumeric 16X2 Big Font LCD for better visibility
02. Electromechanical relay to understand internal mechanism and its working
03. Simultaneous display of voltage, current on LCD
04. Inbuilt automatic timer that starts and stop with relay
05. Inbuilt Power Source for relay
06. Diagrammatic representation of relay connection in transmission line
07. Exclusive and attractive design
08. Designed by considering all the safety standards
09. Learning material CD
10. 2 Year Warranty

Technical Specifications:

Mains Supply	: 230V ±10%, 50Hz
Rheostat	: 110W, 5A
Single Phase Variac	
Input	: 230V

- Output : 0 - 270V
- Current : 0 - 5A
- Over Current Relay**
- Type : Inverse Time
- Normal Voltage : 110V AC, 50Hz
- Current Setting : 0.5A, 0.75A, 1A, 1.25A, 1.50A, 1.75A and 2A
- CT Secondary Measurement : 1A
- Voltmeter : 25 - 300V
- Ammeter : 200mA - 5A
- Timer : 10mSec - 30min

Experiments:

01. To study the IDMT Over Current Relay & its applications
02. To study and use plug setting multiplier
03. To study and use time setting multiplier
04. To study and verify the operating Characteristics of Over Current
05. Relay at various plug & time settings

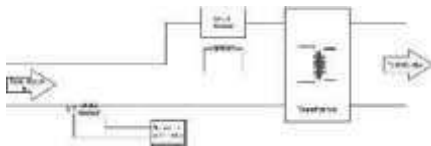

For understanding the role of relays in real time transmission system here a circuit of transmission line is provided from source to distribution with proper placing of all its require components

Characteristic of IDMT Over Current Relay

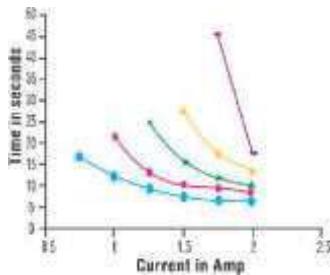

Under Voltage & Over Voltage Relay Testing System

Order Code - 46618



46618 Under Voltage & Over Voltage Relay Training System is intended for advanced practical training in protective devices regarding transmission lines, cables and network sections in power systems lab. A Relay is an electrically operated switch use an electromagnet to operate a switching mechanism mechanically. Relays protect the power distribution equipment against continuing voltage sags that are detrimental to motors, ballasts, etc. 46618 provides theoretical and practical experience to students by controlling, monitoring and analyzing individual relay settings and tripping characteristics. This product provides detailed representation of power transmission system which helps the students to perform experiments with minimal supervision. It also includes built-in variable

supply and fast response graphical LCD display which makes the measurement system very precise.

Features:

01. Alphanumeric 16 x 2 Big Font LCD for better visibility
02. Electromechanical relay to understand internal mechanism and its working
03. Inbuilt Single Phase Variac with isolation
04. Tripping function settings
05. Exclusive and attractive design
06. Diagrammatic representation of relay connection in transmission line
07. Designed by considering all the safety standards
08. Learning material CD
09. 2 Year Warranty

Technical Specifications:

- Mains Supply : 230V ±10%, 50Hz
- Single Phase Variac**
- Input : 230V
- Output : 0-270V
- Current : 0-5A
- Over Voltage Relay**
- Normal Voltage : 110V AC, 50Hz
- Voltage Setting : 121V, 126.5V, 132V, 143V, 137.5V, 148.5V, 154V
- Contacts : 2 N/O, 1 N/C
- Under Voltage Relay**
- Normal Voltage : 110V AC, 50Hz
- Voltage Setting : 44V, 51.3V, 58.6V, 65.9V, 73.2V, 80.5V, 88V
- Contacts : 1 N/O, 2 N/C
- Dimensions (mm) : W 830 x D 350 x H 645
- Weight : 48kg (approximate)

Experiments:

01. study the operating performance of Over Voltage Relay with different plug settings
02. To study the operating performance of Under Voltage Relay with different plug settings

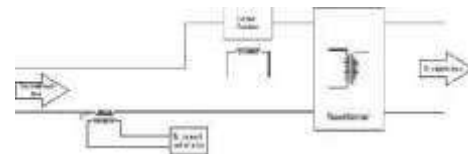

For understanding the role of relays in real time transmission system here a circuit of transmission line is provided from source to distribution with proper placing of all its require components

Earth Fault Relay Testing System

Order Code - 46619



46619 Earth Fault Relay Testing System is designed to provide exposure of protection device used to prevent faults in electrical circuits due to earth leakage current. The protection of electrical system is required to maintain any device in operation without failure. There are various types of protective devices used in Power

Systems. The knowledge of protective devices helps to use them smartly and avoid system breakdown. Earth leakage current gives rise to heat generation and progressive failure of insulation which leads to earth faults & sparks. The Earth Fault Relay detects the leakage current well before they cross threshold limit. 46619 provides complete learning platform related with the connection of Earth Fault Relay in transmission line and testing of Earth Fault Relay. After experimenting with 7094 the students will be able to use Earth Fault Relay in Power Systems.

Features:

01. Inbuilt variable source
02. Big font LCD display for better visibility
03. Isolation transformer is provided for safe operation
04. Exclusive and rugged designed panel
05. Designed by considering all the safety precautions
06. Diagrammatic representation for the ease of connections
07. Learning material CD
08. 2 Year Warranty

Technical Specifications:

Mains Supply : 230V±10%V AC, 50Hz
 Variac
 Input : 230V
 Output : 0-270V
 Current : 0-2A

Isolation Transformer

Rating : 1kVA
 Primary Voltage : 0-230V
 Secondary Voltage : 0-230V

Earth Fault Relay

Type : Electromechanical Inverse Time
 Normal Voltage : 110V AC, 50Hz
 Plug Setting : 0.5A, 0.75A, 1.0A, 1.25A, 1.50A, 1.75A and 2A
 Rheostat : 110W, 5A

Display Measurement Unit

Design Technology : AVR RISC Microcontroller
 Voltmeter : 25 - 300V
 Measurement Method : Direct ADC interface
 Display Resolution : 1V
 Ammeter : 0.2 - 5A
 Measurement Method : CT based ADC interface
 Display Resolution : 0.01A

Timer

Range : 10mSec - 30min
 Operation : Automatic with relay start operating

LCD Specification

No. of lines : 2 No. of Characters in each line
 each line : 16
 MCB : 6A (SPN)
 Dimensions (mm) : W 830 x D 355 x H 630
 Weight : 52kg (approximate)

Experiments:

01. To study and verify the operating characteristics of Earth Fault Relay with different plug setting
02. To study connection of Earth Fault Relay in transmission line
03. To study testing of Earth Fault Relay

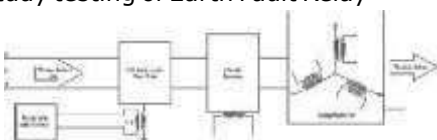

For understanding the role of relays in real time transmission system a circuit of transmission line is provided from source to distribution with proper placing of all its required components.

Differential Relay Testing System

Order Code - 46620



46620 Differential Relay Testing System is a versatile product for electrical laboratories. Various type of relays are used as protection devices in combination with circuit breaker in electrical system. The Different Relay operates due to differential current flowing in the circuit.

When current between two sections vary from a known and permissible value, the relay gets tripped and protects the connected device. The Differential Relay requires two current sources for its operating & testing. For this, two current injection units are provided with the system. The current of both the injection units are displayed on LCD with the differential current to perform the experiment with higher stability & accuracy. The students can understand the working of differential relay by measuring the operating characteristics. They can also learn the connection of this protection device in the electrical circuit.

Features:

01. Alphanumeric 16X2 Big Font LCD for better visibility
02. Electromechanical relay to understand internal mechanism and its working
03. Inbuilt Single Phase Variac with isolation
04. Two variable current injection units
05. Tripping function settings
06. Exclusive and attractive design
07. Diagrammatic representation of relay connection in transmission line
08. Designed by considering all the safety standards
09. Learning material CD
10. 2 Year Warranty

Technical Specifications:

Mains Supply : 230V AC ±10%, 50Hz

Single Phase Variac

Input : 230V AC
 Output : 0 - 270V AC
 Current : 2A

Single Phase Transformer

Input : 230V AC
 Output : 24V AC
 Current : 3A
 Dimensions (mm) : W 830 x D 350 x H 645
 Weight : 62kg (approximate)

Experiments:

01. To study and verify the operating characteristics of Differential Relay with different plug setting
02. To study the connection of Differential Relay in electrical circuit

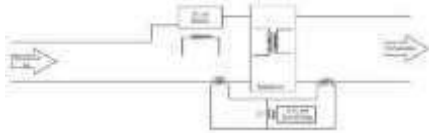

For understanding the role of relays in real time transmission system here a circuit of transmission line is provided from source to distribution with proper placing of all its require components

Synchronization Panel Trainer

Order Code - 46622



46622 in industry loads are directly connected to the source through an isolation switch. But when the load demand is increased and the source capacity is less, another source is connected in parallel so that both the source divides the load current among them. For parallel operation of the sources it is very much essential to have both sources of same voltages, frequency and same phase sequence. This is called the synchronization of the two sources.

Technical Specification:

- * Two digital synchronization size 96x96 is provided.
- * 3 Nos multifunction digital meter (VIF) size 96x96mm to display current voltage frequency.
- * Two synchronization switch MCB 3 pole 16Amp. Is provided.
- * Two set of 3 phase synchronization lamp is provided.
- * Auxiliary switch is provided.
- * Synchronization output with Indicator is provided.
- * 4 pole 10Amp. MCB is provided for 3 sources with terminal.
- * For phase sequence test 1 phase sequence meter with source selector switch and phase sequence switch is provided.
- * Input capacity 3KVA Maximum for each sources.
- * Enclosure made of CR sheet powder coated and screen printed.
- * Necessary BTI connectors for external connection.
- * Designed considering all the safety standards.
- * Dimensions: 650(W) x 450(H) x 350(L).
- * Weight: 18Kg (approximate).

Sequence Control Trainer

Order Code - 46623G



Sequence Control trainer with PLC model 46623G is designed to systematically train sequence control with various actual electric parts. The trainer is available both in single phase and three phase supply operated components. User can design and self try out various applicable experiments in electrical control and protection circuits used in industry. Especially, the

trainer is connectable with PLC trainer and various control logics through ladder programming can be tested.

Earth leakage protective devices. Safety sockets and insulated patch cords are used to enure user safety.

Indication of each elements symbol on the panel.

01. Basic Circuits
02. Local Acting Circuits
03. Relay Sequence Circuits
04. Alarm and Indication Circuits
05. Timer Circuits
06. Delay Staring Circuits
07. Detection Circuits
08. Electric Sequence Control Circuits
09. Understating of control components and individual components operation.
10. Sequence circuit connection experiment
11. Sequence control by proximity sensor
12. Sequence circuit by PLC Control
13. Induction Motor Control Circuit

Technical Specifications:

- * Power Source: 3 phase AC 440V/50-60Hz.
- * Expansion Module : Provision to Multiply the Connection Point
- * Earth Leakage Circuit Breaker : 1 No
Rated Current : 25A
Rated Voltage : 440V
Rated Residual Current at 100mA
- * Contractor Module : 3 nos
4 No with Two Auxiliary Contact Rated Current : 25A
Rated Voltage : 3Phase AC 440V/ 60Hz
Coil Voltage Current : AC 230V 60 Hz
AC1 Ratings : AC 240V/ 4.5kW/ 25A
Auxiliary Contact : AC 240V/ 3A
- * AC Relay 2CO : 3 Nos
Coil Voltage / Current : AC 230V 60 Hz/ 6mA
Rated Current : AC 240/ 3A (Resistive Load),
AC 240V/0.8A (Inductance Load)
- * AC Relay 4CO : 2nos
Coil Voltage / Current : AC 230V 60 Hz/ 6mA
Rated Current : AC 240/ 3A (Resistive Load),
AC 240V/0.8A (Inductance Load)
- * Proximity Sensor : 2 nos
Operating Type : NPN, NO \Detecting Distances
5MM+10%
Standard Detecting Target : Iron (25x25x1mm)
Operating Voltage : DC24V (DC10~30V)
- * Lamp (Green : 2 nos, Red : 3nos)
Operating Voltage : AC 230V Lamp : LED Type
- * Buzzer : 2 Nos
Operating Voltage : AC 230V/4VA
- * Time Relay 1CO - 1no
Set Time : 0-6 Sec\Coil
Voltage/ Current : AC 230V 60Hz/ 60mA
Rated Current : AC 240/ 3A (Resistive Load),
AC 240V/0.8A (Inductance Load)
- * Overload Relay : 2nos.
Rated Current : 9A
Rated Voltage : 3 Phase AC 440V/ 60Hz
Coil Voltage : AC 220V 60Hz
- * Flicker Relay Multifunctional Timer Operating
Voltage 110-240V AC/ 100-125V DC
Rated Current : AC 240V/ 3A (Inductive Load)
- * Toggle Switch : 2 nos
Contact : AC 125V/ 10A, AC 250V/6A

- * Emergency Stop Switch : 1 no
Contact : AC 125V/ 10A, AC 250V/6A
- * Push Button Switch (Green : 2nos, Red: 2 nos)
Contact : AC 250V/6A
- * Selector Switch : 1 no
Contact : AC 125V/ 10A, AC 250V/6A
- * 3 Phase AC Star/ Delta Connection
- * Fuse Holder : Fuse (5A) 3 nos
- * PLC Part - 2
PLC Module 8 Input, 8 Output Delta DVP - 16 ES 2
PLC with programming panel Display Model Delta Tp02
Cable for PLC RS232 -9 pin
SMPS Power Supply : 24VDC at 2A
Program : Input Selectable Programs
Accessories : DC Supply Terminals
- * Shock Proof Safety Sockets : 248 nos
- * Patch Cord Shrouded 1 Meter Red : 20 nos
- * Patch Cord Shrouded 1 Meter Black : 20 nos
- * 3 Phase AC Power Cable : 1no
- * Weight Part-1 and Part-2 : 28.2 KG
- * Dimension (MM) Part-1 : 955Wx450Dx755H
- * Dimension (MM) Part-2 : 415Wx315Dx755H
- * User's Manual : 1 no

- Operating voltage : 24VDC@500mA
- Power : 6W
- Sound level : 105 dB
- Flashing rate : 150 per minute
- * Manual Call Point/ Fire Points (open window type) : 3 Nos.
- Operating voltage : 24VDC
- Resettable type : MCP\
Active : LED glows
- * Conventional Fire Alarm Control Panel : 1 No
Conventional control panel: 4 zones
Supply voltage : 230VAC +/-10%/ 50Hz
Zone indication : Fire, Open, Short, Normal
Status indication : System ON, Mains ON, zone fault, Low battery, CHARGER ON and Fuse Blown
Alarm : Local Buzzer
- * Differential Originator Changing Switch : 3pcs
- * Earth Leakage : 2 pole 230VAC @ 25A, 30mA Circuit Breaker
- * Supply : 230VAC @ 0.5A mains self illuminated Switch & Fuse.
- * AC Power Cable
- * MS Fabricated Powder Painted Control Panel
- * User Manual

Fire Alarm Trainer

Order Code - 46624A

FIRE ALARM TRAINER MODEL - 46624 A : It is basic training course in Fire alarm annunciation technology. The training system consists of various types of Fire sensors, fire sensing & annunciation devices and ancillary components used in fire alarm wiring technology.



Features:

01. Demonstration of various types of Fire sensors
02. Real time activation of fire alarm system
03. Understanding the sensing techniques of fire sensors
04. Study of Fire alarm system and its accessories
05. To learn how to operate the fire control system.
06. Easy connections by safety banana sockets

Technical Specification:

- * Ionization Smoke Sensor : 3 nos.
Operating Voltage : 10V to 30V DC
Temperature : 0 to 400C
Ionization : 0.5uC max Americium 241
Standby Current : 30mA, Alarm: 50mA
- * Air Expansion Smoke Heat Sensor: 3 nos.
Operating Voltage : 10V to 30V DC
Temperature : 0 to 400C
Ionization : 0.5uC max Americium 241
Standby Current : 30mA, Alarm: 50mA
- * Heat Sensor Constant/ Fixed Temp. : 3 nos.
Operating voltage : 10V to 30V DC
Standby current : <55uA
Alarm current : <25mA@12VDC
Alarm output : Remote LED ON,
Temperature trip point : 570C
Operating temperature : -10C ~ +50C, < 95% RH
Detecting range : 50 square meter with the installation height of 6m
- * Emergency Lamp/ Response Indicator: 3 nos.
- * Emergency Bell cum Audio Sounder: 3 nos.

Brush Less DC Motor Trainer

Order Code - 46626



Features:

01. Easy and safe wiring by students due to 4mm sturdy shrouded banana patch cords and shrouded socket arrangement for high voltage circuits
02. Facilitates easy learning about operative characteristics of BLDC motor
03. Each panel has ABS molded plastic sturdy enclosure, and colorful screw less overlays showing circuit diagram & its connection tag numbers for easy understanding and connections
04. Set of Instructor Guide & Student Workbook.

Technical Specifications:

- A] Powder coated sturdy Aluminum flat panel (table top) system, carrying various voltage components housed in plastic enclosures (panel)
- * Instrumentation Power supply cum Multichannel DPM panel (EMT 8)
- * +5V, 300mA
- * Multi channel DPM for digital display for speed
- BLDC-1 panel**
- * 24VDC/3A power supply for BLDC motor]
- * Speed display DPM
- BLDC-2 panel**
- * BLDC controller circuit.
- * BLDC motor
- * Tacho output.
- BLDC-3 panel**
- * Forward/reverse switch.
- * Brake switch
- * Test points for PWM outputs
- * Speed control Pot.
- Brush less DC motor**
- * Voltage: 24VDC

- * Wattage:200W
- * Max Speed: 2500RPM.
- * Frame: 34, panel mounted
- * Bidirectional
- * Braking system

Mechanical specifications

- * Aluminum rack: 4 x 1 matrix used as flat demo panel system to house panels needed for the trainer ordered.
- * Dimensions : 500(H) x 910(L) x 300(D)mm
- * Net Weight : 20kg. Gross Weight : 31kg.
BLDC Moter Net Wt.: 8kg. Gross Wt. : 11kg

Industrial Installation Trainer

Order Code - 46627



Technical Specifications:

A] Flat Aluminum profile sturdy panel (table top) system, 5X3 modular structure, carrying various high voltage components housed in plastic enclosures (panel) to minimise shock possibility.

Input 3 phase DOL Starter panel

- [10 Shrouded Banana]
- * 4 pole MCB of 415 V/1A .
- * DOL 9A Contactor with 230V / 50 Hz / 11VA COIL .
- * Bimetallic thermal O/L relay with range 1.4A - 2.3A .

Lamp Load Panel X 2 nos

- [12 Shrouded Banana]
- * Each panel consists of 230V /15/40/60/100W X 3 bulbs with individual ON/OFF using 6A toggle switch

1 Phase MCB Isolator Panel

- [10 Shrouded Banana]
- * 1Phase MCBs of 2A/ one lamp load,Earth Fault Resistor ELCB 30mA.

Contactor panel X 3 nos

- [28 Shrouded Banana]
- * 9A Contactor with 230V / 50 Hz / 11VA COIL with 3 nos type power contact 2 NO & 2 NC addon Logic contact.

Over Load Relay Panel

- [17 Shrouded Banana]
- * Bimetallic thermal O/L relay with range 440V/1.4A - 2.3A with 3 power contacts, One Tripe & Alarm contact

Push Button Panel

- [24 Shrouded Banana]
- * Consists of Industrial grade Illuminated push button with one NO & one NC contact.
- * Supports One Mushroom Switch, 4 nos of smaller type instruments grade push buttons with one NO & one contact.

3 Pole 7 way CAM Switch Panel

- [27 Shrouded Banana]
- * Consists of 3 pole 7 way CAM switch connection brought out on Banana.

Proximity cum Limit switch Panel

- [6 Banana + 3 Shrouded Sockets]
- * Consists of 2 nos of NPN type proximity sensors operated on 24VDC supply.. Supports One change over type limit Switch with NO & NC contact.

Alarm Annunciator Panel

- [8 Shrouded Banana]
- * Consists of four no potential free fault contacts.
- * Supports four no of fault windows with flashing indication & Alarm annunciation.

24VDC Power Supply Panel

- [16 Banana Sockets]
- * Input 230VAC, output 24VDC/2A.with extenders for connections.

Dual Timer Panel

- [14 Shrouded Banana]
- * Consists of two nos of Individual Timers 24V operated supply coil.
- * Each Timer Supports 2 NO & 1 NC contacts.

Relay Panel

- [16 Banana Sockets]
- * Consists of 8 nos of change over type relays with NO, NC & Common contacts for each with supply coil of 24VDC. Supports lamp LED lamp Indication for outputs.
- * Optional 3 AC Squirrel cage foot mounted motor with 6 terminals brought out for star delta Expt.

List of experiments supported:

01. Study of components in electrical systems and their Operations.
02. Study of Hold ON Contact Logic.
03. Study of interlocking contact logics with trip indication.
04. Study of DOL starter logic.
05. Study of Star-Delta Logic
06. Study of phase reversal logic.
07. Study of Sequential logic to start motors in a process plant using timers & AA panel. Optional experiments with AC/DC drive, PLC
08. Study of Earth keakage fault and Tripping Threshold.

Industrial Installation Trainer

Order Code - 46627A



46627A Industrial Installation Trainer is a rugged training system for the Electrical laboratories mounted on Aluminum profile rack with sturdy table top flat panel. Each panel has ABS molded plastic sturdy enclosure with 4mm shrouded connectors showing circuit diagram & its connection tag numbers for easy understanding and connections. The product helps you to get fully acquainted with the basic concepts and functioning of an Industrial Installation Trainer.

Specifications:

Trainer having control panel should provided in 40X40mm Aluminum profile rack with sturdy table top flat panel. Should have 16 no's of ABS plastic panel mounted on the aluminum rack with mimic diagram All input & output are terminated in 4mm shrouded connector, Should provide 4mm banana cable for experiments.

- * Should have 3phase DOL starter 4pole MCB, contractor & relay panel - 4 pole MCB of 415 V/4A .

- DOL 9A Contactor with 230V / 50 Hz /11VA COIL .
- Bimetallic thermal O/L relay with range 1.4A - 2.3A
- * Should have 3 phase multifunction meter panel .
 - Bidirectional Multifunction
 - 3 Phase ¾ wire, 415V, CT Input 5A
 - LCD/LED display, Aux supply 230V, 45-65 Hz, 5W
 - V, A, Hz, Pf, KVA, KW, KWH
- * Should have 3 Phase Contractor Panel (3nos).
 - 9A Contractor with 230V/50Hz with 3 nos of NO contact.
 - 2 NO & 2 NC contact output
- * Should have 3 Phase Over Load relay Panel.
 - Bimetallic thermal over load relay
 - 440v/1.4A-2.3A range with 3 power contact output.
 - 1 No & 1 NC contact output.
- * Should have Switch Panel-1.
 - 24V DC operated NPN type Proximity Switch
 - One change over type Limit Switch with NO & NC Contact.
 - 3 Pole 7 Way Cam Switch.
- * Should have Switch Panel-2.
 - Mushroom Switch, one No & One NC(2nos)
 - Push Switch, one NO & one NC
 - Toggle Switch 2 way 4 terminal- Illuminated Switch 2 way 4 terminal
 - Illuminated Push Switch, one NO & One NC
- * Should have Industrial Socket Panel.
 - 1 Phase 3 terminal Socket, 16A
 - 3 Phase 5 terminals Socket, 16A
- * Should have Alarm Annunciate Panel.
 - 4 numbers of potential free fault contacts
 - 4 numbers of fault windows with flashing & alarm indication.
- * Should have Timer & AC/DC supply Panel.
 - 2 numbers of 24V DC Timer
 - Each timer support 2 NO & 2 NC contacts
 - 24 DC supply output
 - 1 phase MCB 4A 230V, ELCB 30mA.
- * Should have MCCB Panel.
 - 3 Phase MCCB panel
 - 415V AC,50Hz , 100A NFB
- * Should have Relay Panel-1.
 - 8 numbers of 24V DC SPST relay
 - Led Indication for each relay
 - Each relay support one NO & one NC Contact.
- * Should have Relay Panel-2.
 - 2 numbers of 220V AC SPDT relay
 - Led Indication for each relay
 - Each relay support Two NO & Two NC Contact.
- * Should have Lamp Load panel (2nos).
 - 230V 3 numbers of 100w bulb with socket as a Load.
 - On/OFF toggle should be provided for each bulb socket.
- * Should supply with 3 Phase AC Motor.
 - 1/2HP 3-Phase Induction Motor.
 - 6 terminals provided for Start/Delta operation

Experiment List:

01. Study of components in electrical system & their operation.
02. study of contact logics with trip indication.
03. Study of DOL starter, Contractor.
04. Study of Phase reversal Logic.
05. Study of Timer & relay logics
06. Study for star & delta operation

07. Study of Earth Leakage

Home/ Commercial Wring Installation Trainer

Order Code - 46629



Technical Specification:

A] Aluminum profile sturdy flat demo panel (table top) system, having top row carrying tube, led lamp, metal halide/halogen etc., While bottom 3 rows carry various device panels as below & it is fronted by particle board for wiring practice with inclination settable.

1 phase AC input supply panel

- * 1ph,. MCBs of 4A/1.6A-2Nos

Grounding * protection panel

- * Consists of a 2 pole Earth Leakage Circuit Breaker (ELCB) 25A with current imbalance of 30mA.
- * One No push button to create Earth leakage fault.
- * One SPDT to select HI-leakage or LO-leakage fault.
- * One 15W bulb for Hi-leakage fault & 22KW resistor for Lo leakage fault

Integrated AC (1 phase) measurement

- * 1nos of Digital meter for 1ph. parameter V, I, W, Wh, VA, VAR, Hz, etc.
- * Current specs = 1A/5A for 1ph. meter (170-250V).

AC power supply panel-2nos

- * AC OSARAM power supply for metal halide lamp 70W (max,5KV).
- * Input 230VAC/0.4A

DC power supply panel

- * SMPS power supply for LED
- * Input 230VAC, Output+12V/5A,60W
- * DC supply for down lighter

Switches panel

- * One way switch = 2nos
- * Two way switch = 2nos

Buzzer/ bell switch/ Neon panel

- * Buzzer/bell,I/P230VAC
- * Bell switch
- * Neon lamp indicator
- * Kitkat fuse

Dimmer/ Fault panel

- * Dimmer
- * Fault = 2nos

Sockets panel

- * Three pin AC mains Sockets = 3nos
- * 230V/10A rating

DC switch panel

- * Double pole single through four terminal S/W = 2nos
- * Rating 32A/240VAC

Lamp panel

- * Incandescent lamp - 3nos, CFL tube = 1 no

Various lamp/ Tubes provided

- * Metal Halide lamp (70W)
- * Electronic tube
- * Point source LED
- * Strip LED
- * Electric Tube

Display panel Showing Various wiring accessories

- * Conduit, Elbow joints, casing taping,
- * Cleats, Batten with clips, cable/wires etc.

Wiring practice board (1100X300X20 mm)

- * A replaceable 20 mm particle / PVC board is mounted horizontally between legs like a drawer. It is used for wiring practice by students using self tapping screws & wiring accessories use drilling machine to drill holes. All banging by hammer.

List of experiment:

01. Electrical Safety Rules for working in laboratories
02. Variety of wiring experiments based on above operational panels
03. Study of protective devices panel
04. Study and use of Measurement devices
05. Understanding working of various types of lamps including tube, led & other high intensity lamps
06. Hands on wiring practice using cables, casing and hand tools

Accessories:

Drill machine, screw driver set self, self tapping screws, drill bits (3mm,4mm)

Mechanical Dimension (mm) of Trainer:

- * 1170(L) X 300(W) X 900(H)
- * Net Weight: 42kg.

Anti - Theft Trainer

Order Code - 46630



Feature:

01. Facilitates easy and safe wiring by Student due to 4mm sturdy shrouded banana patch cords and shrouded socket arrangement for high voltage circuits.
02. Each panel has ABS molded plastic sturdy enclosure, and colorful screw less overlays showing circuit diagram & its connection tag nos. for easy understanding & connections.
03. Set of Instructor Guide & student Workbook

Technical Specification:

A] Aluminum profile modular panel rack system (Table top) carrying various components housed in plastic enclosures (panels) to minimize shock possibility in top two rows. The bottom two rows hold a wooden door with different sensors mounted on it.

1 phase AC & 12VDC/ 3A Input supply panel

- * 12VDC/3A supply
- * 3nos of 230VAC supply with fuse protection & on-off switch for each

Lamp panel

- * Incandescent lamp (15W)=3no
- * Bulb on-off switch for each bulb

Relay panel

- * 8 nos of LED Indicators
- * 8 nos of relay with coil rating of 12VDC & contact rating of 220VAC/1A.

PI R motion sensor panel

- * Passive infrared sensor
- * Relay output contact with load 1200W max (GLS lamp), 600W max (CFL TL)
- * Supply voltage 230VAC
- * Detection angle 150 degree
- * Preset for Lux level 10 lux to 2000lux, time 20 sec

to 20min, sensitivity setting preset under the cover.

Ultrasonic motion sensor panel

- * Ultrasonic sensor
- * Supply voltage 230VAC
- * Relay output contact with load 15A incandescent, electronic or magnetic fluorescent ballast
- * Detection angle 360 degree
- * Detection range 1000SF
- * reset for Lux level 20 lux to 300 lux, time 30 min, sensitivity setting preset under the cover.

Window safety sensor panel

- * Window door open up to 90 degree
- * Diffuse photo sensor with 12-24VDC operated, sensing distance of 300mm, emitter source if red LED, NPN open collector output with max load current of 100mA.
- * Through beam photo sensor with 12-24VDC operated, sensing distance of 10 meters, emitter source of red LED, NPN open collector o/p with max load current of 100mA.
- * Magnetic reed switch with NC contact rating of 12VDC/ 100mA, sensing distance of 25mm.

Output camera panel

- * Integral Unit Containing: · Output camera · Bell switch · Microphone · Loud speaker · Infrared sensor
- * Visual angle 92°

Indoor video panel

- * Color video monitor with three keys, monitor, Unlock & talk
- * Screen size 3.5² · 12VDC supply operated

Door safety panel

- * Simulated wooden door with size of 370 (L) X 400(H) X 70(W) with mechanical key lock
- * Electric strike lock 12VDC/950mA operated, holding capacity of 600lbs
- * Electromagnetic door lock 12VDC/2A operated, holding capacity of 230Kg.
- * Glass break cum magnetic sensor 12VDC/22mA operated with NC contact of rating 25VDC/100mA

Siren with flasher panel

- * Operating voltage: 12VDC@500mA
- * Power: 6W
- * Sound Level: 105dB
- * Flashing rate: 150/min.

List of Experiment:

01. To work with PIR (Passive infrared) motion sensor.
02. To work with Ultrasonic motion sensor.
03. To work with diffuse photo sensor .
04. To work with through beam photo sensor.
05. To work with magnetic reed switch.
06. To work with electric strike lock.
07. To work with electromagnetic door lock.
08. To work with glass break (vibration) cum magnetic sensor.
09. To work with video door phone & remote door control.

Mechanical Dimension (mm)

- * 1170(L) X 3020(W) X 990(H)

Fire Alarm Trainer

Order Code - 46631



Features:

01. 2-zone conventional fire alarm control panel.
02. Has built in standby batteries to demonstrate working of FAT system in case of mains supply failure.
03. Facilitate hands on training through use of 4mm patchcords by constructing FAT circuit using various fire detectors.
04. Each panel has ABS molded plastic sturdy overlays showing circuit diagram & its connection tag nos. For easy understanding & connections.
05. Provides real time simulations and activation of the fire alarm control system .
06. Set of Instructor Guide & Student Workbook.

Technical Specifications:

A] Aluminum profile modular flat demo panel rack system (table top) carrying various components housed in plastic enclosures (panels) to minimize shock possibility, in top three rows. The bottom row holds control panel with batteries.

1 phase AC Input Supply panel

- * 1ph. dual MCBs of 2A for short circuit protection

Smoke detector panel

- * Photoelectric smoke sensor
- * Operating voltage - 12VDC
- * Standby current - 20uA
- * Alarm current - 35mA@12VDC
- * Alarm output - Remote LED
- * Temperature - 0% ~ 95%RH

Heat detector panel

- * Operating voltage: 12VDC
- * Static current : <55uA
- * Alarm current : <25mA@12VDC
- * Alarm output : Remote LED ON,
- * Temperature tripe point : 135°F (57°C)
- * Operating temperature :- 10°C~+50°C, <95%RH
- * Detecting range :50 square meter with the installation height of 6m; 12m

Manual call point(MCP) panel

- * Operating voltage: 12VDC
- * Resettable type: MCP
- * Active/de active LED indication
- * Push to activate & deactivate by plastic key

Siren with flasher panel

- * Operating voltage: 12VDC@500mA
- * Power: 6W
- * Sound level: 105dB
- * Flashing rate: 150 per minute

Gas (LPG) Leak detector panel

- * Operating voltage: 12VDC
- * Relay output contacts with max: 24V@1A
- * Inbuilt alarm indication buzzer
- * Inbuilt heat detector (trip point 60°C)

Control panel

- * 2-Zone conventional control panel
- * Supply voltage: 230VAC + /-10%/50Hz/max X 2W

- * 12VDC (6V,4.5A X2nos) rechargeable battery backup
- * Zone indication: Fire detection, sensor open, sensor short, sensor bypass & zone test indication
- * Status indication - system ON, fire indication, reset key hit, silence key hit, zone fault & siren ON
- * Fault indication : AC fail, Hooter fail, Battery low
- * 5 keys keypad
- * Keypad enable /desable by key lock
- * Relay output for siren with max: 24VDC@5A
- * Operating temperature: 0 to 50° C, <95% RH
- * Auxiliary output: 12VDC/500mA

List of Experiment:

01. To Work with smoke detector/sensor
02. To Work with heat detector/sensor
03. To Work with Gas (LPG) leak detector/sensor
04. To Work with manual Call point (MCP)
05. To Work with siren with flasher
06. To Work with Microcontroller based panel [2 Zone]

Mechanical Dimension (mm) and Weight

- * 1170(L) X 300(W) X 990(H)
- * Net Weight : 25kg
- * Gross Weight : 35kh.

Solar Technology Trainer

Order Code - 46632



Features:

01. Table top aluminum profile flat demo panel rack with tilttable lockable frame 0-90° in steps to mount SPV modules 2nos.
02. Employs 500W X 2 nos halogen lamps as variable intensity sun simulator.
03. Renewable energy basics, energy conservation, charge controller, storage system, alternating current & Invertor (optional)
04. Optional single phase Grid tide Invertor to demonstrate power export using bidirectional multifunction meter.
05. Temperature control using peltier module to study temperature effect.
06. Facilitates understanding of underlying physics by measuring carrier life time & spectral response of a solar cell.
07. Set of Instructor Guide & Student Workbook

Technical Specifications:

SCR actuator cum sensor signal conditioning panel

- * Supports signal conditioning circuit for temperature to give output 2-2.5Vdc
- * To control the temperature by controlling IR lamp by P/PI controller & signal conditioning of sensor

Instrumentation power cum multichannel DPM panel

- * +12V,-12V,@500mA,&+5V@300mA.
- * Multi channel DPM for temperature display.
- * 20 pin FRC power bus to supply power to neighboring panel.

Solar cell experiment panel

- * 50 X 50 mm X 2nos ,solar cells
- * Loading pots (500E and 5K).
- * Series parallel combination arrangement.
- * PT 100 sensor to measure temperature.
- * Cooling Fan to cool heatsink.

Spectral Response & carrier Lifetime Measurement panel

- * 11 different wavelength LED`s @ constant 20/30mA current to determine spectral response parameter.
- * 50 X 50 mm X 2nos. Solar cells.
- * White led bank of 8 LED`s to determine carrier life time parameter.
- * IP 12 W switch to select different wave length LEDs.

Solar application panel

- * 12V LED lamp and fan.

Dimmer panel

- * Dimmers 3 nos. to set intensity of halogen lamp.

DMM panel

- * DC Voltmeter (0-100V)
- * DC Ammeter (0-5A)

MPPT Battery Charge panel (Optional)

Solar water pump panel (Optional)

Stand alone Invertor panel (Optional)

Table top aluminum profile rack consist of

- * 20W X 2 photo-voltaic (PV) modules mounted on tiltable lockable aluminum frame. (PV module dimensions 500 X 400 X 35 mm)
- * 500W Halogen lamp 2 nos to simulator sun in laboratory.
- * Solar cell experiment panel to study solar characteristics
- * Rheostat as load for SPV modules (800E,2.5A)

List of Experiment:

01. Study of I-V characteristic of Solar cell.
02. Study of I-V characteristic of Solar PV module.
03. Study of series parallel combination of solar cells.
04. Study of series parallel combination of solar PV modules.
05. Study of dependency of solar cell I-V characteristics on light intensity (irradiation).
06. Study of dependency of solar cell I-V characteristics on temperature.
07. Measurement of Carrier Lifetime for a solar cell.
08. Measurement of Spectral Response for a solar cell.
09. Study of power output of a solar module depending on the angle fo incidence (tilt angle) of the light.
10. Study of shading effect on solar cell parameters.
11. Study of photovoltaic effect in ubiquitous semiconductor PN junction (diode)

Mechanical Dimensions (mm)

- * 1170(L) X 300(W) X 900(H)
- * Tilttable lockable frame : 1020(L) X 550(W)

Combined Earth fault and Over current numerical Relay Kit

Order Code - 46640



Order Code - 46640 IDMT Over Current & Earth Fault

Relay Testing Kit is a rouged training system for the Electrical laboratories mounted on Aluminum profile rack with sturdy table top flat panel. Each panel has ABS molded plastic sturdy enclosure with 4mm shrouded connectors showing circuit diagram & its connection tag numbers for easy understanding and connections. The product helps you to get fully acquainted with the basic concepts and functioning of an DMT Over Current & Earth Fault Relay Testing Kit.

Specifications:

- * 1 phase AC Input supply panel
 - 1ph. MCBs of 4A/1.6A - 2nos.
 - Bulb Load.
- * Variable voltage & current injector panel
 - Consist of 1 phase dimmer 230VAC/1A
 - Short circuit transformer with primary 230VAC/1A, secondary 0-2-8V/12A taps.
- * Over current & elapsed time measurement panel
 - Consists of AC ammeter of 20A
 - Elapsed time counter range 999.001 sec, resolution 1 msec.
- * Over Current Relay Panel
 - All the connection of relay are brought out on this panel.
 - 2 NO trip contacts.
 - Relay Coil
- * Protection relay type (Numerical)
 - IDMT over current with Earth Fault Numerical Relay, current rating 5A, with current setting
- * To perform experiment on IDMT over current protection.
- * To perform experiment on earth fault protection

Distance Protection Relay Kit

Order Code - 46641



Order Code - 46641 Distance Protection Relay Trainer Is a rouged training system for the Electrical laboratories mounted on Aluminum profile rack with sturdy table top flat panel. Each panel has ABS molded plastic sturdy enclosure with 4mm shrouded connectors showing circuit diagram & its connection tag numbers for easy understanding and connections. The product helps you to get fully acquainted with the basic concepts and functioning of a Distance Protection Relay Trainer

Specifications:

- * Trainer control panel is provided in 40X40mm Aluminum profile rack with sturdy table top flat panel.
- * It has 8 no's of ABS plastic panel mounted on the aluminum rack with mimic diagram of components
- * All input & output are terminated in 4mm shrouded connector and 4mm banana cable is provided for experiments.
- * 3 phase DOL starter 4pole MCB, contractor & relay panel
 - 4 pole MCB of 415 V/4A
 - DOL 9A Contactor with 230V / 50 Hz /11VA COIL
 - Bimetallic thermal O/L relay with range 1.4A -

2.3A

- R-Y-B Input display Indicators.
- Manual start / stop with local trip contact
- Separate NO contact brought out for auto re-closer & NC for trip.
- * 3 phase multifunction meter panel (2Nos)
 - Bidirectional Multifunction
 - 3 Phase ¾ wire, 415V, CT Input 5A
 - LCD/LED display, Aux supply 230V, 45- 65 Hz, 5W
 - V, A, Hz, Pf, KVA, KW, KWH
 - Modbus RTU RS 485
- * Distance Relay Panel
 - Relay connection are brought out on front panel
 - 2 NO Trip contacts, 1 NC Trip contacts, 1 NO Auto reclose contact.
 - Auxiliary Supply of 230VAC.
- * Protection relay type (Numerical)
 - Numerical type distance protection relay, current rating 1A/5A for protection of transmission line - RS232 port for PC communication, relay setting with software on CD
 - RS232 to USB converter for USB interface
- * Star / Star Step down transformer panel
 - 415/110VAC, 50VA, Star/Star Step Down Transformer Panel
 - Transformer primary and secondary are brought on 4mm shrouded socket on Front panel.
- * CT panel
 - Six numbers of 5/5 Amp. CT.
- * FWD/REV Switch panel (1 No)
 - FWD/REV, 3 pole 3 way switch, 6A/440V
- * 1 Ph AC Input supply Panel
 - 1ph 230V/2A & 230V/4A AC output supply.
 - 1 ph. MCBs of 4A.
 - Lamp Load socket with 100W Bulb
- * Table Top Transmission line Panel
 - Simulated model for short transmission line using Resistance R (10 ohm/600W)
 - Six numbers of Inductance L(0.15H/5A)
 - Six numbers of Capacitance C (2.2uF/630V)
 - Simulated model for medium length 125kms & long length 250kms transmission line.
 - Two numbers of Fan provided for Air cooling.
- * Table top Resistive Load panel
 - 3 numbers of 600W resistors with switch selectable
 - Switch of 7 way at 100, 112, 125, 150, 175, 200 & 225 Ohm selection.
 - Two numbers of Fan provided for Air cooling

Accessories:

01. Set of Shrouded Cables
02. Set of Manuals with Experiments.
03. Demo CD showing Experiments

Optional Accessories:

01. Working Table (KWT-01)....1 No
02. Multimeter ... 1 No
03. Tool Kit... 1 No

Experiment Motor List:

01. Study of No Load Test.
02. Study of Ferranti Effect.
03. Study Determination of transmission line ABCD parameter.
04. To perform experiment for distance protection of transmission line LG, LL, LLL, LLLG.

05. To perform experiment for auto recloses function of the relay for transient type faults.

Feeder Protection Relay Kit

Order Code - 46646



Order Code - 46646 Feeder Protection Relay Trainer is a rugged training system for the Electrical laboratories mounted on Aluminum profile rack with sturdy table top flat panel. Each panel has ABS molded plastic sturdy enclosure with 4mm shrouded connectors showing circuit diagram & its connection tag numbers for easy understanding and connections. The product helps you to get fully acquainted with the basic concepts and functioning of a Feeder Protection Relay Trainer.

Specifications:

- * Trainer control panel is provided in 40X40mm Aluminum profile rack with sturdy table top flat panel.
- * It has 16 no's of ABS plastic panel mounted on the aluminum rack with mimic diagram.
- * All input & output are terminated in 4mm shrouded connector and 4mm banana cable is provided for experiments.
- * 3phase DOL starter 4pole MCB, contractor & relay panel
 - 4 pole MCB of 415 V/4A.
 - DOL 9A Contactor with 230V / 50 Hz /11VA COIL.
 - Bimetallic thermal O/L relay with range 1.4A - 2.3A
 - R-Y-B Input display Indicators.
 - Manual start / stop with local trip contact
- * 3 phase multifunction meter panel
 - Bidirectional Multifunction
 - 3 Phase ¾ wire, 415V, CT Input 5A
 - LCD/LED display, Aux supply 230V, 45- 65 Hz, 5W
 - V, A, Hz, Pf, KVA, KW, KWH
 - Modbus RTU RS 485
- * 1 Ph AC Input supply Panel
 - 1ph 230V/2A & 230V/4A AC output supply.
 - 1 ph. MCBs of 4A.
 - Lamp Load socket with 100W Bulb
- * FWD/REV Switch panel
 - FWD/REV, 3 pole 3 way switch, 6A/440V.
- * Over current & elapsed time measurement panel (3 Nos)
 - AC ammeter
 - Elapsed time counter
- * Variable Voltage Panel (3 Nos).
 - 1 phase dimmer Input 230VAC/1A, Output 270VAC/1A.
- * Variable AC/DC and Current Injector panel (3 Nos)
 - 1 phase dimmer 230VAC/1A
 - Short circuit transformer with primary 230VAC/1A, secondary 0-2-8V/12A taps.
- * CT panel
 - Six numbers of 5/5 Amp. CT.
- * Star / Star Step down transformer panel

- 415/110VAC, 50VA, Star/Star Step Down Transformer Panel
- Transformer primary and secondary are brought on 4mm shrouded socket on Front panel.
- * Table Top Feeder manager relay panel
 - Numerical Type Feeder Protection Relay,
 - Current rating 1A/5A for protection of feeder.
 - USB port for PC communication, relay setting with software on CD

Accessories:

01. Set of Shrouded Cables
02. Set of Manuals with Experiments.
03. Demo CD showing Experiments

Optional Accessories

01. Working Table.... 1 No
02. Multimeter ... 1 No
03. Tool Kit... 1 No

Experiment List

01. Study the working of IDMT over current protection.
02. Study the working of under/over voltage protection.
03. Study the working of under/over frequency protection.
04. Study the working of earth fault protection.
05. Study the working of negative sequence over current protection.
06. Study the working of zero sequence over voltage protection.
07. Study the working of negative sequence over voltage protection.
08. Study the working of Local breaker backup (LBB) function protection

Electrical Machine Trainer

Order Code - 46800



Features :

01. Facilitates easy and safe wiring by students due to use of 4mm sturdy Shrouded banana patch cords & shrouded socket arrangements.
02. All machines are mounted on finely painted sturdy base frame with easy machine interchangeability. Use of gear coupling facilitates screwless coupling. Use of gear coupling facilitates screwless coupling
03. With due emphasis on student safety machines operate upto 300W power levels and upto 1500 RPM, without compromising on didactic use. Able to draw all graphs. Contact factory for 3 HP EMT Trainer.
04. Trunnion mounted DC Integrated machine is

used as Dynamometer for loading other machines (Motors/ generators both); unlike magnetic powder brake or eddy current brake which can load only coupled Motors and not generators, with facility to measure shaft power using electronic torque / speed Measurement

Panels Provided:

01. Aluminum Machine trainer Rack..... 69700 Qty.1
02. Input 3 phase DOL Starter panel..... 69701 Qty.1
03. Multifunction Meter (Single Phase/Three Phase AC 50Hz)..... 69702 Qty.2
04. FWD/REV, Star-Delta starter panel..... 69703 Qty.1
05. Rotor Resistor Cum 3Phase Synchronous Motor Control..... 69704 Qty.1
06. 1 Phase Motor, Alternator & Sync. Motor 69705 Qty.1
07. DC voltmeter & Ammeter and Torque Measurement Meter..... 69706 Qty.2
08. Variable DC Power Supply..... 69707 Qty.2
09. Input Single Phase DOL Starter Panel AC DC Fix / Variable Supply..... 69708 Qty.2
10. AC Load Resistor..... 69709 Qty.1
11. DC Load Resistor..... 69710 Qty.1
12. AC Load Inductor..... 69711 Qty.1
13. Capacitive (C) Load..... 69712 Qty.1
14. Lamp Load..... 69713 Qty.1
15. Synchroscope / 3 Phase Alternator Synchronizer 69714 Qty.1
16. Extension Board..... 69715 Qty.1

Motors Provided:

01. DC Integrated (Trunion Mounted) Motor..... 69301 Qty.2
02. 3 Phase AC Integrated Motor..... 69302 Qty.2
03. 3 Phase Salient Pole Alternator..... 69303 Qty.1
04. 1 Phase. Synchronous Motor..... 69304 Qty.1
05. 1 Phase AC Integrated Motor..... 69305 Qty.1
06. Universal Motor..... 69306 Qty.1
07. DC Integrated (Foot mounted) Motor.. 69309 Qty.1
08. 1 Phase AC Integrated Motor (69305) with loading arrangement..... 69310 Qty.1
09. 3 Phase AC Integrated Motor (69302) with loading arrangement 69311 Qty.1
10. 3 Phase Squirrel Cage Induction Motor (69308) with loading arrangement..... 69312 Qty.1
11. Repulsion Motor (69307) with loading arrangement..... 69313 Qty.1

Accessories Provided:

- 01 Hand held digital Tachometer..... 01
- 02 Shrouded connecting leads 4mm 50cm Red..... 20
- 03 Shrouded connecting leads 4mm 50cm Black.... 20
- 04 Shrouded connecting leads 4mm 100cm Red..... 20
- 05 Shrouded connecting leads 4mm 100cm Black... 20

DC MOTOR COUPLED 3PH. AC MOTOR TRAINER (46801)

Provided- Panels: 69700 to 69704, 69706 to 69710, 69715 **Motors:** 69301, 69302 & **Accessories**

Experiments:

01. speed torque curve of DC shunt motor with 3 phase AC integrated motor
02. speed torque curve of DC series motor with 3 phase AC integrated motor
03. speed torque curve of separately excited DC motor

- with 3 phase AC integrated motor
- 04. speed torque curve of DC compound motor with 3 phase AC integrated motor
- 05. v-i efficiency curve of DC shunt generator with 3 phase AC integrated motor
- 06. v-i efficiency curve of DC series generator with 3 phase AC integrated motor
- 07. v-i efficiency curve of separately excited DC generator with 3 phase AC integrated motor
- 08. v-i efficiency curve of DC compound generator with 3 phase AC integrated motor
- 09. v-i efficiency curve of occ of shunt generator with 3 phase AC integrated motor
- 10. speed torque curve of would rotor induction motor with rotor shorted and with Different rotor resistance
- 11. DOL starter
- 12. Star delta starter
- 13. Rotor resistance starter
- 14. Application of synchronous motor as pf improvement device-v curves
- 15. Synchronous generator v-i curves

DC MOTOR COUPLED 3PH. SALIENT MOTOR TRAINER (46802)

Provided- Panels: 69700 to 69703, 69706 to 69712, 69715 **Motors:**69301, 69303 & Accessories

Experiments:

- 01. speed torque curve of DC shunt motor with 3 phase salient motor
- 02. speed torque curve of DC series motor with 3 phase salient motor
- 03. Speed torque curve of separately excited DC motor with 3 phase salient motor
- 04. Speed torque of DC compound motor with 3 phase salient motor
- 05. v-i efficiency curve of DC shunt generator with 3 phase salient motor
- 06. v-i efficiency curve of DC series generator with 3 phase salient motor
- 07. v-i efficiency curve of DC separately excited generator with 3 phase salient motor
- 08. v-i efficiency curve of DC compound generator with 3 phase salient motor
- 09. v-i efficiency curve of occ of shunt generator with 3 phase salient motor
- 10. Speed torque of 3ph. synchronous motor
- 11. Efficiency and input power factor measurement 3ph. synch. motor
- 12. Study of 'v' curve and inverted 'v' curve
- 13. output volt -amp charACteristics of synchronous generator
- 14. Efficiency of synchronous generator
- 15. Performance of R, L, and C load

DC MOTOR COUPLED 1PH. AC MOTOR TRAINER (46803)

Provided- Panels: 69700, 69702, 69705 to 69708, 69713, 69715 **Motors:**69301, 69305 & Accessories

Experiments

- 01. speed torque curve of DC shunt motor with 1 phase AC integrated motor
- 02. speed torque curve of DC series motor with 1 phase AC integrated motor

- 02. Speed torque curve of separately excited DC motor with 1 phase AC integrated motor
- 03. Speed torque of DC compound motor with 1 phase AC integrated motor
- 04. v-i efficiency curve of DC shunt generator with 1 phase AC integrated motor
- 05. v-i efficiency curve of DC series generator with 1 phase AC integrated motor
- 06. v-i efficiency curve of DC separately excited generator with 1 phase AC integrated motor
- 07. v-i efficiency curve of DC compound generator with 1 phase AC integrated motor
- 08. v-i efficiency curve of occ of shunt generator with 1 phase AC integrated motor
- 09. speed torque curve of split phase induction motor
- 10. speed torque curve for CSIR
- 11. Speed torque curve of CSCR

DC MOTOR COUPLED 1PH. SYNCH. MOTOR TRAINER (46804)

Provided- Panels: 69700, 69702, 69705 to 69709, 69711 ot 69713, 69715 **Motors:**69301, 69304 & Accessories

Experiments

- 01. speed torque curve of DC shunt motor with 1 phase synchronous motor
- 02. speed torque curve of DC series motor with 1 phase synchronous motor
- 03. Speed torque curve of separately excited DC motor with 1 phase synchronous motor
- 04. Speed torque of DC compound motor with 1 phase synchronous motor
- 05. v-i efficiency curve for DC shunt generator with 1 phase synchronous motor
- 06. v-i efficiency curve for DC series generator with 1 phase synchronous motor
- 07. v-i efficiency curve for DC separately excited generator with 1 phase synchronous motor
- 08. v-i efficiency curve for DC compound generator with 1 phase synchronous motor
- 09. v-i efficiency curve for occ of shunt generator with 1 phase synchronous motor
- 10. Speed torque curve of synchronous motor
- 11. Efficiency and input power factor measurement of 1ph. synch. Motor.
- 12. Study of 'V' curve of 1ph. synch. Motor.
- 13. Out volt-amp charACteristics of synchronous motor
- 14. Efficiency of synchronous generator.
- 15. Performance with R, L and C load.

DC MOTOR COUPLED WITH UNIVERSAL MOTOR TRAINER (46805)

Provided- Panels: 69700, 69702, 69706 to 69708, 69710 to 69713, 69715 **Motors:**69301, 69306 & Accessories

Experiments

- 01. speed torque curve of DC shunt motor with universal motor
- 02. speed torque curve of DC series motor with universal motor
- 03. Speed torque curve of separately excited DC motor with universal motor
- 04. Speed torque of DC compound motor with universal motor
- 05. v-i efficiency curve for DC shunt generator with universal motor

06. v-i efficiency curve for DC series generator with universal motor
07. v-i efficiency curve for DC separately excited generator with universal motor
08. v-i efficiency curve for DC compound generator with universal motor
09. v-i efficiency curve for occ of shunt generator with universal motor
10. Speed torque curve of universal motor when operated with 180VDC
11. Study of efficiency of universal motor for various loading condition.

DC MOTOR COUPLED WITH DC MOTOR TRAINER (46806)

Provided- Panels: 69700, 69706 to 69708, 69710, 69713, 69715 **Motors:** 69301, 69309 & Accessories

Experiments

01. Speed torque curve and efficiency of DC shunt motor with DC motor
02. Speed torque curve and efficiency of DC series motor with DC motor
03. Speed torque curve and efficiency of separately excited DC motor with DC motor
04. Speed torque curve and efficiency of DC compound motor with DC motor
05. Output volt-amp characteristics of DC shunt generator with DC motor
06. Efficiency of DC shunt generator with DC motor
07. Output volt-amp characteristics of DC separately excited generator with DC motor
08. Efficiency of DC separately excited generator with DC motor
09. Output volt-amp characteristics of DC series generator with DC motor

SYNCHRONIZATION/ PARALLELING OF 2 THREE PHASE ALTERNATOR TRAINER (46807)

Provided- Panels: 69700, 69701, 69702/ 2, 69703, 69704, 69706/ 2, 69707/ 2, 69708/ 2, 69709, 69710, 69714, 69715 **Motors:** 69301/ 2, 69302/ 2, & Accessories

Experiments

01. speed torque curve of DC shunt motor with 3 phase AC integrated motor
02. speed torque curve of DC series motor with 3 phase AC integrated motor
03. Speed torque curve of separately excited DC motor with 3 phase AC integrated motor
04. Speed torque of DC compound motor with 3 phase AC integrated motor
05. v-i efficiency curve for DC shunt generator with 3 phase AC integrated motor
06. v-i efficiency curve for DC series generator with 3 phase AC integrated motor
07. v-i efficiency curve for DC separately excited generator with 3 phase AC integrated motor
08. v-i efficiency curve for DC compound generator with 3 phase AC integrated motor
09. v-i efficiency curve for occ of shunt generator with 3 phase AC integrated motor
10. Speed torque curve of wound rotor induction motor with rotor shorted and with different Rotor resistance.
11. DOL/Star-delta starter, rotor resistance starter.

12. Application of sync. Motor as pf improvement device-V curve.
13. Synchronous generator V-I curves.
14. Dark lamp method[all lamps are dark]
15. Bright lamp method[all lamps are bright]
16. 1 Dark 2 Bright lamp method.

1 PHASE AC INDUCTION MOTOR TRAINER (46808)

Provided- Panels: 69700, 69702, 69705, 69715, **Motors:** 69310 & Accessories

Experiments

01. Study of speed-torque characteristics of single phase induction motor (split phase type).
02. Study of efficiency and input power factor of 1phase induction motor (split phase type) for various loading conditions.
03. Study of speed-torque characteristics of single phase induction motor (capacitor start type).
04. Study of efficiency and input power factor of 1phase induction motor (capacitor start type) for various loading conditions.
05. Study of speed-torque characteristics of single phase induction motor (capacitor start-run Type).
06. Study of efficiency and input power factor of 1phase induction motor (capacitor start-run type) for various loading conditions.
07. Study of "No Load Test" and "Blocked Rotor Test ". on 1 phase Induction Motor.

3 PHASE AC SLIP RING INDUCTION MOTOR TRAINER (46809)

Provided- Panels: 69700 to 69704, 69706 to 69708, 69715 **Motors:** 69311 & Accessories

Experiments:

01. Speed torque characteristics of 3 ph. wound rotor induction motor with variable rotor Speed torque characteristics of 3 ph. wound rotor induction motor with variable rotor Resistance.
02. Efficiency of input power factor measurement of 3 ph. wound rotor induction motor.
03. Speed torque characteristics of 3 ph. Short-circuited rotor induction motor.
04. Efficiency of input power factor measurement of 3 ph. short-circuited rotor Inductions motor.
05. Speed torque characteristics of 3 ph. synchronous motor.
06. Efficiency of input power factor measurement of 3 ph. synchronous motor.
07. Use of synchronous motor as power factor improvement device. study of 'v' curves
08. Study of Direct On Line (DOL) starter for three phase induction motor.
09. Study of star delta-starter for 3 ph. induction motor.
10. Study of rotor resistance starter for three phase wound rotor induction motor.
11. Study of direction of reversal for 3 phase induction motor.

3 PHASE SQUIRREL CAGE INDUCTION MOTOR TRAINER (46810)

Provided- Panels: 69700 to 69704, 69708, 69715 **Motors:** 69312 & Accessories

Experiments

01. Speed torque characteristics of 3 phase squirrel cage induction motor.
02. Efficiency, % slip and input power factor measurement of 3 phase squirrel cage induction motor.
03. Speed control of squirrel cage induction motor by pole changing method.
04. 'No Load Test' & 'Blocked Rotor Test' on 3 ph. squirrel cage induction motor.

REPLUTION MOTOR TRAINER (46811)

Provided- Panels: 69700, 69702, 69706 to 69708, 69710, 69715 Motors: 69313 & Accessories

Experiments:

01. Study of speed torque characteristics of Repulsion motor.
02. Study of efficiency and input power factor measurement of single phase Repulsion motor.
03. Speed control and reversal of direction of rotation of repulsion motor.

Technical Specification of Panel

Input 3 Phase Dol Starter Panel

Order Code - 69701

01. MCB 4 pole 4Amp.
02. DOL 9A Contactor with 415V / 50 Hz / 11VA COIL .
03. RYB Indicator
04. Emergency Switch
05. Shrouded socket 8Nos.
06. Push button switch for Stop/Start



Multifunction Meter (Single Phase/ Three Phase AC 50Hz) - Order Code - 69702

01. Bidirectional Multifunction Meter
02. 3 Phase 4 wire, 440V, Current 5A
03. LED display,
04. Aux supply 230V, 45-65Hz, 5W
05. To measure parameters ie Voltage Current., KVA, Frequency, Power factor, Active Power (W), React Power (vary) etc.
06. Shrouded socket 08Nos. etc.



Fwd/ rev And Star-delta Starter Panel

Order Code - 69703

01. FWD/REV, 3 pole 3 way Switch with centre OFF, 10A/ 440V.
02. Star/Delta switch 3 pole, 3 way with centre OFF, 10A/ 440V.
03. Shrouded socket 12Nos.



Rotor Resistor Cum 3phase Synchronous Motor Control - Order Code - 69704

01. Rotor resistors of 30E/5A with 3 taps of 15E, 21E, 30E each - 3 Nos.
02. Rotor resistor selector switch, 3 pole. 6 Way 10A/440V.
03. DC Rotor excitation with circuit breaker (3Amp)
04. Shrouded socket 7Nos.



1 PH. Motor, Alternator & Sync. Motor Order Code - 69705

01. 1 ph. MCBs of 4A/1.6A 1 each.
02. 2 no. 2P2W selector switches to run as 1ph. Alternator then as synchronous motor.
03. 2A push button switch to simulate as centrifugal switch.



4. 1 Lamp load holder with lamp
5. Shrouded socket 14Nos.

DC Voltmeter & Ammeter With Torque Measurement Meter

Order Code - 69706

01. TWO DPM DC voltmeter (0-1000V)
02. TWO DPM DC Ammeter (020A)
03. Torque Measurement Meter
04. Shrouded socket 16Nos.



Variable Dc Power Supply

Order Code - 69707

01. Half bridge SCR based 0V-200V / 3 Amp cosine firing with linear characteristics, 3 Nos. Switch SPDT to On/Off with indication
02. Three Nos. of these supplies required for DC Armature, DC motor field and AC generator field.
03. Shrouded socket 8Nos.



Input Single Phase Dol Starter Panel Ac Dc Fix / Variable Supply - Order Code - 69708

01. MCB 2 pole 10A with indicator
02. Emergency Switch
03. Push button switch for Stop/Start
04. DOL 9A Contactor with 230V / 50 Hz / 11VA Coil .
05. Shrouded socket 4Nos.

Variable AC Supply (0-200V)

01. Shrouded socket 6Nos.

Fix/ Variable DC Supply (0-200V)

01. Shrouded socket 4Nos.



AC Load Resistor - Order Code - 69709

- 1 AC Resistors 10K/5K/3.5K/2.5K/2K/1.5K/OFF 200W x 3 phases/ 6 taps
- 2 Load Resistance switch 3 POL 7 Way/ 10Amp.
- 3 Cooling Fan size 4" 230V Operated
- 4 Shrouded socket 12Nos.



DC Load Resistor - Order Code - 69710

01. 750E/600E/300E/212E/162E/ 125E/ 112E/100E/400W /8 taps + OFF + separate 60E tap For DC series Gen.
02. Load Resistance switch 3 POL 7 Way/ 10Amp.
03. Cooling Fan size 4" 230V Operated
04. Shrouded socket 6Nos.



AC Load Inductor - Order Code - 69711

01. Inductive load =0.15H/0.3H/ 0.45H/ 0.6H/0.75H/1.5H/3H/ 400mA X 3Nos.
02. Load inductor switch 3 Pole 7 Way/ 10Amp.
03. Shrouded socket 12Nos.



Capacitive (C) Load - Order Code - 69712

01. Capacitive load =1.25μF /2.5mF/5mF/ 440VX 3Nos
02. Shrouded socket 18Nos.



Lamp Load - Order Code - 69713

01. 3 Nos. Lamp 100W with Holder & switch
02. Shrouded socket 12Nos.



Synchroscope / 3 Ph. Alternators Synchronizing
Order Code - 69714

01. Synchroscope:- Rotating light meter with 28 LED on a circular scale and a zero voltage differential Indication with 2 LED
02. 3 Phase Alternator Synchronizing
03. Synchronization indication for qualitative indication of the phase relationship between mains and



Extension Board - Order Code - 69715

01. Operating Voltage 230VAC \pm 10% at 50Hz
02. ON OFF Switch with indicator
03. Eight Nos. five pin 5 Amp Electrical Sockets



AC Voltmeter & AC Ammeter and Reversing Switch
Order Code - 69716

01. Two Digital AC Voltmeter 3½ Digit Having Dual range of 0-200V /600V
02. Two Digital AC Ammeter 3½ Digit having Dual range of 0-2A / 20A
03. Four DPDT Switches for Dual DPM
04. Reversing Switch
05. Power socket for AC I/P
06. Power on off Switch
07. Shrouded socket 20Nos

Digital Wattmeter - Order Code - 69717

01. Two Digital Wattmeter having range of 0-250V, 0-5Amp. = 1250W Aux. supply 230V.
02. Power socket for AC I/P
03. Power on off Switch
04. Shrouded socket 12Nos

Phase Sequence & VIF/ PF Meter
Order Code - 69718

01. Phase Sequence meter Operating Voltage 110v \pm 20%
02. Digital Power factor mater (VIF / PF) 230V 5Amp.
03. Power socket for AC I/P
04. Power on off Switch
05. Shrouded socket 9 Nos

Aluminum Frame - Modular Panels
Order Code - 69700

Electrical motor trainer rack made up aluminium profile size 40x40mm, foldable and light in weight 10 panel setup can be interchange conveniently to perform experiments. Dimention Length 1100 x Hieght 1000 x Depth 350mm.



Technical Specification of Motors
DCI ntegrated (Trunion Mounted) Motor
Order Code - 69301



Voltage : Varm = 180V Vfield = 180V
Capacity - 300W/2 Pole m/c, **RPM -** 1500, **Shrouded Socket -** 12
Rotor Construction: Standard commutator / brush arrangement with laminated stack, brought out on 2 terminals
Stator construction : Separately excited field winding with laminated solid yoke 2 pole and series winding brought out on 4 terminals.
Toque characteristic: Provision of load cells 6 Kg. 2 No. assembly to measure the torque .

3 Phase Ac I ntegrated Motor
Order Code - 69302

Voltage : 415VAC, 50Hz
Capacity - 300W/4 Pole m/c, **RPM -** 1500, **Shrouded Socket -** 18
Rotor Construction : Star connected, four terminals including star point brought out on 4 slip rings mounted on shaft.
Stator construction : Six terminals to be brought out to start the motor using STAR-DELTA starter.



3 Phase Salient Pole Alternator
Order Code - 69303

Voltage : 415VAC, 50Hz
Capacity - 300W/4 Pole m/c, **RPM -** 1500, **Shrouded Socket -** 12
Rotor Construction : Star connected, four terminals including star point brought out on 4 slip rings mounted on shaft.
Stator construction : Separately excited field winding with laminated solid yoke, 4 pole brought out on 2 terminals



1 Phase. Synchronous Motor
Order Code - 69304

Voltage : 230 VAC, 50Hz
Capacity - 300W/4 Pole m/c, **RPM -** 1500, **Shrouded Socket -** 8
Rotor Construction : Single phase wound rotor with terminals brought out on two slip rings mounted on shaft.
Stator construction : One winding will be used to configure synchronous motor & Alternator output when used as single phase generators.



1 Phase Ac I ntegrated Motor
Order Code - 69305

Voltage : 230 VAC, 50Hz
Capacity - 300W/4 Pole m/c, **RPM -** 1500 **Shrouded Socket -** 18
Rotor Construction : Diecast Squirrel cage motor
Stator construction : Two windings brought out on 4 terminals for main and auxilliary. These will be used to configure different motors Split phase, CSCR, CSIR.



Universal Motor - Order Code - 69306

Voltage : 230 VAC, 50Hz / 150VDC
Capacity - 300W/4 Pole m/c, **RPM -** 1500, **Shrouded Socket -** 8
Rotor Construction : Standard commutator brush arrangement brought out on 4 terminals
Stator construction : Stator brought out on 4 terminals to facilitate AC/DC operation and direction change. Built in compensating winding to minimize AR and sparking.



Repulsion Motor - Order Code - 69307

Voltage : 230 VAC, 50Hz

Capacity - 300W/4 Pole m/c, **RPM -** 1500, **Shrouded Socket -** 4

Rotor Construction : Standard commutator brush but short circuited.

Stator construction : Stator brought out on 4 terminals. Settable handle to rotate brush position w.r.t. Neutral axis.



3 Phase Squirrel Cage Induction Motor

Order Code - 69308

Voltage : 415 VAC, 50Hz

Capacity - 300W/4 Pole m/c, **RPM -** 1500, **Shrouded Socket -** 12

Rotor Construction : Diecast Squirrel cage motor

Stator construction : 6x2 terminals brought out to run machine at two speeds using pole changing method (Dahellander Winding)



DC INTEGRATED (FOOT MOUNTED) MACHINE - Order Code - 69309

Voltage : $V_{arm} = 180V$ $V_{field} = 180V$

Capacity - 300W/4 Pole m/c, **RPM -** 1500, **Shrouded Socket -** 12

Rotor Construction: Standard commutator / brush arrangement with laminated stack, brought out on 2 terminals

Stator construction : Separately excited field winding with laminated solid yoke 2 pole and series winding brought out on 2 terminals.



01. 1 Phase Ac Integrated Motor (69305) With Loading Arrangement - Order Code - 69310
02. 3 Phase Ac Integrated Motor (69302) With Loading Arrangement - Order Code - 69311
03. 3 Phase Squirrel Cage Induction Motor (69308) With Loading Arrangement - Order Code - 69312
04. Repulsion Motor (69307) With Loading Arrangement - Order Code - 69313
05. Universal Motor (69306) With Loading Arrangement - Order Code - 69314

Klystron Microwave Test Bench-1

Order Code - 10401



The Microwave Test Benches are precision made microwave systems, which use standard type rectangular wave-guide components to illustrate the essential elements of this field for study.

The equipment consist of :

- 01. A selection of wave-guide components
- 02. The power supply for the microwave source
- 03. A detector
- 04. A meter, which monitors the detector output
- 05. Wall Chart
- 06. Microwave Components Chart

These Training Benches are completely self-contained & provide the means to allow students to carry out practical work at extremely low cost. A Comprehensive manual containing extensive microwave theory and a progressive series of assignments is supplied with the Trainer.

Experiments:

- 01. Study of Reflex Klystron
- 02. Frequency, Guide Wavelength Measurement
- 03. SWR, Reflection Co-efficient Measurement
- 04. Impedance Measurement

Instruments:

SKPS -----	1
VSWR Meter -----	1

Components:

Cooling Fan -----	1
Detector Mount -----	1
Fixed Short -----	1
D.R.F. Meter -----	1
Isolator -----	1
Klystron Mount -----	1
Matched Termination -----	1
Movable Short -----	1
S S Tuner -----	1
Slotted Section -----	1
Tunable Probe -----	1
Variable Attenuator 20 dB -----	1
Wave Guide Stand -----	3

Accessories:

Cable BNC - BNC -----	1
Mains Cord -----	2
Op. Manual -----	1

Gunn Microwave Test Bench-2

Order Code - 10402



The Microwave Test Benches are precision made microwave systems, which use standard type

rectangular wave-guide components to illustrate the essential elements of this field for study.

The equipment consist of :

- 01. A selection of wave-guide components
- 02. The power supply for the microwave source
- 03. A detector
- 04. A meter, which monitors the detector output
- 05. Wall Chart
- 06. Microwave Components Chart

These Training Benches are completely self-contained & provide the means to allow students to carry out practical work at extremely low cost. A comprehensive manual containing extensive microwave theory and a progressive series of assignments is supplied with the Trainer.

Experiments:

- 01. Study of Gunn Oscillator
- 02. Frequency, Guide Wavelength Measurement
- 03. SWR, Reflection Co-efficient Measurement
- 04. Impedance Measurement

Instruments:

GPS -----	1
VSWR Meter -----	1

Components:

Cooling Fan -----	1
Detector Mount -----	1
Fixed Short -----	1
D.R.F. Meter -----	1
Gunn Oscillator -----	1
Isolator -----	1
Matched Termination -----	1
Movable Short -----	1
Pin Modulator -----	1
S S Tuner -----	1
Slotted Section -----	1
Tunable Probe -----	1
Variable Attenuator 20 dB -----	1
Wave Guide Stand -----	3

Accessories:

Cable BNC - BNC -----	2
Mains Cord -----	2
Cable N type to TNC -----	1
Op. Manual -----	1

Gunn Microwave Test Bench-3 (Dielectric)

Order Code - 10403



The Microwave Test Benches are precision made microwave systems, which use standard type rectangular wave-guide components to illustrate the essential elements of this field for study.

The equipment consist of :

- 01. A selection of wave-guide components
- 02. The power supply for the microwave source
- 03. A detector
- 04. A meter, which monitors the detector output

- 05. Wall Chart
- 06. Microwave Components Chart

These Training Benches are completely self-contained & provide the means to allow students to carry out practical work at extremely low cost. A comprehensive manual containing extensive microwave theory and a progressive series of assignments is supplied with the Trainer.

Experiments:

- 01. Dielectric Constant Measurement of Solids
- 02. Dielectric Constant Measurement of Liquid
- 03. Phase Shift Measurement

Instruments:

GPS-----	1
VSWR Meter-----	1

Components:

Cooling Fan -----	1
Detector Mount -----	1
D.R.F. Meter-----	1
Gunn Oscillator -----	1
Isolator -----	1
Liquid Dielectric Cell -----	1
Phase Shifter -----	1
Pin Modulator -----	1
Precision Short -----	1
Slotted Section -----	1
Solid Dielectric Cell-----	1
Tunable Probe -----	1
Variable Attenuator 20 dB -----	1
W/G Cavity Resonator-----	1
Wave Guide Stand -----	3

Accessories:

Cable BNC - BNC -----	2
Mains Cord -----	2
Op. Manual -----	1
Cable N type to TNC-----	1
Samples of Solid Dielectric -----	1

Klystron Microwave Test Bench-4 (Antenna)

Order Code - 10404



The Microwave Test Benches are precision made microwave systems, which use standard type rectangular wave-guide components to illustrate the essential elements of this field for study.

The equipment consist of :

- 01. A selection of wave-guide components
- 02. The power supply for the microwave source
- 03. A detector
- 04. A meter, which monitors the detector output
- 05. Wall Chart
- 06. Microwave Components Chart

These Training Benches are completely self-contained & provide the means to allow students to carry out practical work at extremely low cost. A comprehensive

manual containing extensive microwave theory and a progressive series of assignments is supplied with the Trainer.

Experiments:

- 01. Measurement of Radiation Pattern of Antennas
- 02. Measurement of Gain of Antennas
- 03. Measurement of Polar Pattern of Antennas

Instruments:

SKPS -----	1
VSWR Meter-----	1

Components:

Coaxial W/G Adaptor -----	2
Cooling Fan-----	1
Detector Mount -----	1
Dielectric Antenna -----	1
D.R.F. Meter-----	1
E-Plane Sectoral Horn -----	1
H-Plane Sectoral Horn -----	1
Isolator -----	1
Klystron Mount -----	1
Parabolic Dish-----	1
Pick Up Horn Antenna -----	1
Pyramidal Horn -----	1
Radiation Pattern Turn Table-----	1
Slotted Broad Wall-----	1
Slotted Narrow Wall-----	1
Standard Gain Horn Antenna-----	1
Variable Attenuator 20 dB -----	1
Wave Guide Stand -----	3
Wave Guide Twist -----	1

Accessories:

Mains Cord -----	2
Cable BNC - BNC-----	2
Bends to Connect Antenna -----	2
Cable N Type to N Type -----	1
Pair of Bend to connect Antenna -----	1

Klystron Microwave Test Bench-5

Order Code - 10405



The Microwave Test Benches are precision made microwave systems, which use standard type rectangular wave-guide components to illustrate the essential elements of this field for study.

The equipment consist of :

- 01. A selection of wave-guide components
- 02. The power supply for the microwave source
- 03. A detector
- 04. A meter, which monitors the detector output
- 05. Wall Chart
- 06. Microwave Components Chart

These Training Benches are completely self-contained & provide the means to allow students to carry out practical work at extremely low cost. A comprehensive manual containing extensive microwave theory and a

progressive series of assignments is supplied with the Trainer.

Experiments:

01. Study of E-Plane, H-Plane & Magic Tees
02. Study of Directional Couplers
03. Study of Fixed and Variable Attenuators
04. Study of Isolator and Circulators

Instruments:

SKPS-----	1
VSWR Meter -----	1

Components:

Cooling Fan-----	1
C.D.Coupler 20 dB-----	1
Detector Mount-----	1
D.R.F.Meter-----	1
E-Plane Bend-----	1
E-Plane Tee-----	1
Fixed Attenuator 10 dB-----	1
Fixed Attenuator 3 dB-----	1
Fixed Attenuator 6 dB-----	1
H-Plane Bend-----	1
H-Plane Tee-----	1
Isolator-----	1
Klystron Mount-----	1
Magic Tee-----	1
Matched Termination-----	2
Movable Short-----	1
M H D Coupler 10 dB-----	1
M H D Coupler 3 dB-----	1
S S Tuner-----	1
Slotted Section-----	1
T Circulator-----	1
Y Circulator-----	1
Tunable Probe-----	1
Variable Attenuator 20dB-----	1
Wave Guide Stand-----	3

Accessories:

Mains Cord-----	2
Cable BNC - BNC-----	2
Op. Manual-----	1

Gunn Microwave Test Bench-6

Order Code - 10406



The Microwave Test Benches are precision made microwave systems, which use standard type rectangular wave-guide components to illustrate the essential elements of this field for study.

The equipment consist of :

01. A selection of wave-guide components
02. The power supply for the microwave source
03. A detector
04. A meter, which monitors the detector output
05. Wall Chart
06. Microwave Components Chart

These Training Benches are completely self-contained & provide the means to allow students to carry out

practical work at extremely low cost. A comprehensive manual containing extensive microwave theory and a progressive series of assignments is supplied with the Trainer.

Experiments:

01. Measure the gain of a waveguide Horn Antenna
02. Study & Measurement with Multihole Directional Coupler
03. Study of Magic Tee, Q & Bandwidth Measurement in cavity resonator

Instruments:

GPS-----	1
VSWR Meter -----	1

Components:

Coaxial W/G Adaptor-----	1
Cooling Fan-----	1
Detector Mount-----	1
D.R.F. Meter-----	1
E-Plane Bend-----	2
Fixed Attenuator 10 dB-----	1
Fixed Short-----	1
Gunn Oscillator-----	1
H-Plane Bend-----	1
Isolator-----	1
Magic Tee-----	1
Matched Termination-----	1
Movable Short-----	1
M H D Coupler 10 dB-----	1
Pin Modulator-----	1
Pyramidal Horn-----	1
S S Tuner-----	1
Slotted Section-----	1
Standard gain Horn Antenna-----	1
Tunable Probe-----	1
Variable Attenuator 20 dB-----	1
Wave Guide Stand-----	3
W/G Cavity Resonator-----	1

Accessories:

Mains Cord-----	2
Cable BNC - BNC-----	2
Op. Manual-----	1
Cable N type to TNC Cable-----	1

Advanced Microwave Integrated Circuit Lab

Order Code - 10411-10411A



Advanced Microwave Integrated Circuit Lab includes instruments and accessories for studying the characteristics of any MIC (Microwave Integrated Circuits) component over the Frequency Range 2.2 to 3GHz. Characteristics and measurements like Transmission Loss and Reflection Loss of different MIC components can be studied with the help of instruments provided with Order Code- 10411 / 10411A. Directivity and Gain of Antennas can also be measured with the setup provided. The theoretical background on these components and experimental

details are provided in the learning material.

Features:

01. Complete setup with Generator, MIC Components and Meter.
02. Gold Plated Components and Connectors.
03. Microwave Generator with internal AM and FM.
04. PC to PC Data Communication.
05. Antenna Radiation Pattern measurement.
06. Directivity and Gain measurement.
07. 2 Year Warranty

This Training System Includes:

01. Microwave Generator (2.2 - 3GHz)
02. VSWR Meter
03. MIC Components
04. Learning Material
05. Transmitting and Receiving mast

Experiments:

- * PC to PC Data Communication using MIC components.
- * Measurement of Transmission Loss and Reflection Loss.
- * Measurement of substrate dielectric constant using Ring Resonator.
- * Measurement of power division, isolation and return loss characteristics.
- * Measurement of coupling, isolation and return loss characteristics.
- * Measurement of coupling and directivity.
- * Measurement of Low Pass Filter characteristics.
- * Measurement of Band Pass Filter characteristics.
- * Measurement of Band Stop Filter characteristics.
- * Measurement of characteristics of Patch Antennas.
- * Measurement of characteristics of an MIC Amplifier.
- * To study RF switch.
- * To study RF Mixer.
- * Measurement of Guide wavelength, Free Space Wavelength and SWR using Measuring Line.
- * Measurement of Directivity and Gain of Antennas : Yagi Antenna, Patch Antenna, Dipole Antenna.
- * To study the characteristics of Isolator.
- * To study the characteristics of Circulator.

MIC Components (10411/70411A)

- 50W Microstrip Line (**Both**)
- Band Stop Filter (**Both**)
- Parallel line Directional Coupler (15 dB) (**Both**)
- Wilkinson Power Divider (3 dB) (**Both**)
- Branchline Directional Coupler (3 dB) (**Both**)
- Low Pass Filter (**Both**)
- Band Pass Filter (**Both**)
- Ring Resonator (**Both**)
- Rat-Race Hybrid Ring Coupler (3 dB) (**Both**)
- MIC Patch Antennas (2 Nos.) (**Both**)
- Yagi antenna (**Both**)
- Dipole Antenna (**Both**)
- MIC Amplifier (**Both**)
- RF Switch Optional (**Both**)
- RF Mixer **Optional**
- Local Oscillator **Optional**
- Measuring Line **Optional**
- Isolator **Optional**
- Circulator **Optional**
- Vector Network Analyser (3MHz-3GHz) **Optional**

Accessories:

- * Matched Loads (5 Nos.)
- * Short
- * Coaxial Detector
- * Microstrip Directional Coupler (10 dB)
- * SMA to SMA Adapters (Both male & female)
- * SMA (male) connector fitted cables
- * Attenuator (3 dB)
- * +12V DC Adaptor
- * Transmitting and Receiving Mast
- * SMA (Male) to BNC (Female) adaptor
- * 3-pin Lunar cable

Wave and Propagation Trainer

Order Code - 10412



The Wave and Propagation Trainer is a useful training system for the Laboratories. It helps student to learn Wave Properties and Propagation results. Concepts of Reflection, Refraction, Polarization, Diffraction, Interference, Standing waves and Interferometer can be understood very easily. The setup mainly consists of Microwave Transmitter, Microwave Receiver, Goniometer scale. Along with this setup a number of other accessories are provided to perform different experiments. A user friendly manual is provided with this system to help student in performing the experiments and to understand the topic theoretically.

Features:

01. A Complete set for Transmission, Reception and Measurement of Microwave Power
02. Digital displays are provided for relative strength measurement of microwave
03. Complete set of accessories for performing the experiments of Reflection, Refraction, Polarization and Interference etc.
04. Audio / Voice communication facility is provided
05. Provided with a detector probe for field detection
06. Accessories are provided in a carrying case
07. Provided with a detailed Operating manual

Technical Specifications:

Frequency of Operation	: 10 GHz (approx)
Power of Transmission	: 10 -15 mW
Operating Voltage	: 8 V (approx)
Antennas for Transmission & Reception	: Horn type
Goniometer Scale	: 0° - 360°
Tone Generator	: 1 KHz Frequency
Transmitter and Receiver arm length	: 49 cm each (approx)
Power Display Measurements	: Digital, Relative
Power Supply	: 230 V ±10%, 50 Hz

Accessories:

- Microwave Transmitter : Metal Plates of different dimensions
- Microwave Receiver : Partial Reflectors
- Transmitter Arm : Din Connectors Cables
- Receiver Arm : Metal Plate holder
- Goniometer Base Unit : Polarization Grille

Detector Probe : Prism Stand
Prism : Microphone

Microwave Power Meter

Order Code - 10413



Features:

01. Low Cost for educational use with microwave bench
02. 8.2 to 12.4GHz X band measurement range
03. 0.1dB resolution
04. Digital Display on backlit LCD with bargraph
05. Wide range from +20dBm(100mW) to -30dBm(1uW)
06. dB relative mode
07. Measurement in dBm, mW, dBr, dBW, dBuW
08. Shock/Drop resistant Thermistor Sensor
09. In built X band source for scalar network analysis

Technical Specifications:

Power Meter

Frequency range : 8.2GHz to 12.4 Ghz
Display : 16X2 Backlit LCD
Power : +20dBm to -30dBm
Measurement : dBm, dBr, mW, dBW, dBuW With Digital Display
Resolution : 0.1, 0.5 and 1dB
Offset : For relative measurement
Level Indicator : Digital display and Bar Graph
Power : 100-240VAC, 47-63 Hz

Power Sensor

Frequency Range : 8.2GHz to 12.4 GHz
Power range : +20dBm to -30dBm
Compensation : Temperature compensated thermistor
Cable : Sensor/meter cable 3m

Microwave Source

Frequency : 10.3 Ghz typical
Power level : 1mW typical

List of Experiments:

01. To learn different ways of measuring power.
02. To evaluate the accuracy of the power measurements.
03. To plot the power output of Gunn/Klystron Oscillator with supply voltage.
04. To plot the power output of a Gunn/Klystron Oscillator with frequency.
05. Study of square law modulation and square law characteristics of a crystal detector.
06. To measure PIN modulator insertion loss & modulation depth.
07. To measure the accuracy of SWR meter reading.
08. To calculate the relationship between Q and bandwidth of resonance cavity.
09. To measure the insertion loss of the waveguide.
10. To measure the insertion loss in the main line of a directional coupler.
11. To measure the coupling factor of a directional coupler.
12. To measure the isolation & directivity of a directional coupler.
13. To measure the return loss of a unknown load.

14. To measure the decoupling between H and E arms of magic Tee.
15. To measure the insertion loss of the hybrid Tee.
16. To measure the return loss of H arm in a magic Tee.
17. To measure and plot the attenuation characteristics of variable attenuator.
18. To measure the attenuation of a fixed attenuator.
19. To measure the input SWR of attenuator.
20. To measure the gain of a pyramidal horn.
21. To plot the E and H Plane polar pattern of a antenna and compute the beamwidth.
22. To measure the coupling coefficient of a waveguide E & H Plane Tee.
23. To measure the isolation of a waveguide E & H plane Tee.
24. To measure the input VSWR of a E & H plane Tee.
25. To study the operation of ferrite circulator and measure its insertion loss.
26. To measure isolation of a ferrite circulator.
27. To measure the cross coupling of a circulator.
28. To study the variation of characteristics of ferrite circulator with frequency.

Microwave Components

Order Code - 10501-10555



Klystron Power Supply

Order Code - 10501

Klystron Power Supply, is a state-of-the-art solid-state, regulated Power Supply for operating low power Klystrons tube.

It incorporates a number of proprietary features:

01. Regulated Beam Supply and Repeller Supply voltages.
02. LED Digital metering for Beam voltage, current and Repeller voltage.
03. Compact and Reliable.
04. Modular construction for easy maintenance.

In addition to AM and FM modulation of Beam current, a provision for externally modulating the Klystron supply with desired signal waveform has been provided.

Klystron Power Supply utilizes the quality components and rugged construction. A careful handling of the instrument will provide years of trouble free service. The equipment is divided in two parts one is high voltage unit and other is modulation unit. It makes it user friendly.

Technical Specifications

Beam Supply : Voltage : 190 - 420 V DC, Variable

Current : 50 mA

Regulation : 0.5 % for 10% I/P variation

Ripple : < 5m Vrms

Repeller Supply : -10 to -240V DC Variable

Regulation : 0.25%, for 10% I/P variation

Filament Supply : 6.3 VDC

Over-Load Trip Current : 50mA

Modulation : AM (Square) FM (Saw-tooth)

Frequency Range : 500-2000 HZ 50-150 Hz

Amplitude : 0-110 Vpp 0-60 Vpp

External : For External Modulating Signal

Display : Digital display for
 1. Beam voltage
 2. Beam Current
 3. Repelled voltage
 Modulation Selector : CW/AM/FM/EXT/MIC
 Connectors : a. 8-Pin Octal Socket
 b. BNC for External Modulation
 Power Supply : 230 V AC \pm 10%, 50Hz
 Dimensions (mm) : 315 x 225 x 130
 Connectors : a. 8-Pin Octal Socket
 b. BNC for External Modulation
 Power Supply : 230 V AC \pm 10%, 50Hz
 Dimensions (mm) : 315 x 225 x 130

VSWR meter
Order Code - 10502



The VSWR meter model is a high gain low noise, tuned voltmeter operating at fixed frequency. It is designed for making standing wave measurement in conjunction with a suitable detector and slotted line or wave guide section. It may be used as null detector in bridge circuit and as fixed frequency indicator. It is calibrated to indicate directly VSWR or dB when used with square law devices such as crystal diode. It is adjusted for operation at 980Hz to 1020 Hz to avoid harmonics of the line frequency.

Technical Specifications

Display : LCD (16 X 2)
 Sensitivity : 0.1V for 200 input impedance
 Noise Level : Less than 0.02V
 Range : 0 60dB in 10dB steps
 Input : Un-biased low and high impedance crystal biased crystal (200 and 200K)
 Display Select : VSWR 1 9, dB 0 10
 Modes : Normal Audio
 PC (this mode can be used only with Gunn based bench)
 Gain Control : Adjusts the reference level, variable range 0-10dB (approximately)
 Input Connector : BNC (F)
 Input Frequency : 1000Hz \pm 10%
 Power : 230 Volts AC \pm 10%, 50Hz
 Dimension (mm) : 295 x 200 x 95

Gunn Power Supply
Order Code - 10503



Gunn Power Supply comprises of an electronically regulated DC Power Supply and a square wave generator designed to operate Gunn oscillator and PIN modulator simultaneously. The DC voltage is variable from 0 to 10 volts. The frequency of square wave can be continuously varied

from 800 to 1200 Hz. The front panel meter can read the Gunn voltage and the current drawn by the Gunn diode. The Power Supply is designed to protect Gunn diode from reverse voltage application from over voltage transients and from low frequency oscillations.

Technical Specifications

Display : LCD (16 X 2)
 Voltage Range : 0 to 10V
 Current : 750 mA maximum
 Stability : 0.1 % for + 10% mains variation
 Ripple : 1.0 mV typical
 Mode Select : Continuous wave
 Internal Modulation (Square wave output), Audio Modulation PC data Modulation
 Int. Modulating Frequency : 800 to 1200 Hz
 Int. Modulating Voltage : 0 10 Vpp variable
 Output Connector : BNC for Gunn Bias
 PC-Interface : RS232
 Dimension (mm) : 285 X 200 X 95

Item Name	Order Code
Coaxial Waveguide Adaptor	Order Code - 10504
Cooling Fan	Order Code - 10505
Cross Directional Coupler 20 dB	Order Code - 10506
Detector Mount	Order Code - 10507
Dielectric Antenna	Order Code - 10508
E-Plane Bend	Order Code - 10509
E-Plane Sectoral Horn Antenna	Order Code - 10510
E-Plane Tee	Order Code - 10511
Fixed Attenuator 3 dB	Order Code - 10512
Fixed Attenuator 6 dB	Order Code - 10513
Fixed Attenuator 10 dB	Order Code - 10514
Fixed Short	Order Code - 10515
Frequency Meter - Digital	Order Code - 10516
Gunn Oscillator	Order Code - 10517
H-Plane Bend	Order Code - 10518
H-Plane Sectoral Horn Antenna	Order Code - 10519
H-Plane Tee	Order Code - 10520
Isolator	Order Code - 10521
Klystron Mount Only - No	
Klystron Tube	Order Code - 10522
Liquid Dielectric Cell	Order Code - 10523
Magic Tee / E-H Tee	Order Code - 10524
Matched Termination	Order Code - 10525
Movable Short	Order Code - 10526
Multi Hole Directional Coupler 10 dB	Order Code - 10527
Multi Hole Directional Coupler 3 dB	Order Code - 10528
Parabolic Dish Antenna	Order Code - 10529
Phase Shifter	Order Code - 10530
Pick Up Horn Antenna	Order Code - 10531
Pin Modulator	Order Code - 10532
Precision Short	Order Code - 10533
Pyramidal Horn Antenna	Order Code - 10534
Radiation Pattern Turn Table	Order Code - 10535
S. S. Tuner	Order Code - 10536
Slotted Antenna Broad Wall	Order Code - 10537
Slotted Antenna Narrow Wall	Order Code - 10538
Slotted Section	Order Code - 10539
Solid Dielectric Cell	Order Code - 10540
Standard gain Horn Antenna	Order Code - 10541
T Circulator	Order Code - 10542

Tunable Probe
 Variable Attenuator 20 dB
 Wave Guide Stand
 Wave Guide Twist
 Wave Guide Cavity Order Code - 10547
 Y Circulator
 Samples of Solid Dielectric
 Smith Chart (100 Pc Pad)
 Crystal Diode IN 23
 Cable BNC - BNC
 Cable TNC - TNC
 Tripod Stand
 Low Pass Filter -

Order Code - 10543
 Order Code - 10544
 Order Code - 10545
 Order Code - 10546
 Order Code - 10548
 Order Code - 10549
 Order Code - 10550
 Order Code - 10551
 Order Code - 10552
 Order Code - 10553
 Order Code - 10554

Microwave Component
 HIgh Pass Filter -
 Microwave Component
 Band Pass Filter -
 Microwave Component
 Cable N Type to TNC
 Cable N Type to N Type
 Microphone + Headphone
 Fastners (Brass Fly-Net Set)
 Waveguide Bend to
 Connect Antenna
 Cable N type to BNC

Order Code - 10555
 Order Code - 10556
 Order Code - 10557
 Order Code - 10558
 Order Code - 10559
 Order Code - 10560
 Order Code - 10561
 Order Code - 10562
 Order Code - 10563



Microwave Components - 10501 to 10555

Component Chart

Component Chart showing various microwave components and test benches, including:

- Waveguide Stand
- Waveguide Twist
- Waveguide Cavity
- Y Circulator
- Samples of Solid Dielectric
- Smith Chart (100 Pc Pad)
- Crystal Diode IN 23
- Cable BNC - BNC
- Cable TNC - TNC
- Tripod Stand
- Low Pass Filter
- Microwave Component
- HIgh Pass Filter
- Microwave Component
- Band Pass Filter
- Microwave Component
- Cable N Type to TNC
- Cable N Type to N Type
- Microphone + Headphone
- Fastners (Brass Fly-Net Set)
- Waveguide Bend to Connect Antenna
- Cable N type to BNC

TESCA Technologies
 Website: www.tescaglobal.com

305, Tarachhaya Nagar, Baram Ki Road, Baram-201020, India.
 Tel: +91-141-2774326; Mob: +91-9413330745; Email: info@tesca.in; tesca-technologies@gmail.com

DC Shunt Machines

Order Code - 69001



DC Machines have been the running horse for the Industry since 100 Years, Shunt motors have been the most used due to their very simple speed control, Ruggedness & High Torque capabilities.

This Model is the Industrial/Educational model suitable for demonstrating to students the complete know of the Basics, Components, Starting methods, Wear & Tear & Maintenance of these motors packaged in small rating. Students can make connections of their own with the help of the terminations provided for study of features viz Starting methods, Speed control, Speed-Torque, Effects of Field voltage, Effects of Armature voltage, Motor/Generator operation.

Technical Specification :

Power ratings available : 350W / 750W / 1KW / 2 KW / 3KW/ 5KW

Voltage Input : 220V DC
Excitation : 220V DC
Armature : 220V DC
RPM : 1500 / 3000 RPM
Single / Double shaft extension, SPDP, IP23, IC01, B3, Class-B, S1, Solid Yoke

List Of Experiments:

01. Behavior of Resistance Cut off method of starting
02. Behavior of Voltage control method of starting
03. Speed Control & Over speed operations
04. Load test & No load test of machine
05. Speed-Torque Analysis
06. Voltage-Speed Analysis
07. Efficiency Analysis
08. Analysis of Commutation
09. Cold Resistance & Hot Resistance
10. Motor Operation parameters
11. Generator Operation parameters
12. Basic Overhauling Know how.

DC Series Machines

Order Code - 69002



DC Machines have been the running horse for the Industry since 100 Years, Where ever Heavy Torque is required Series motors are the option, these motors need load to start, these motors have the tractive effect & are even named as Traction motors, applications like railways, material handling machines use such motors. This Model is the Industrial/Educational model suitable for demonstrating to students the complete know of the Basics, Components, Starting methods, Wear & Tear & Maintenance of these motors packaged in small rating. Students can make connections of their own with the help of the terminations provided for study of features viz Starting methods, Speed control, Speed-Torque, Effects of Armature voltage, Behaviour with Load, Motor/Generator operation.

Technical Specification :

Power ratings available : 350W / 750W / 1KW / 2 KW / 3KW/ 5KW
Voltage Input : 220V DC
Armature : 220V DC
RPM : 1500 / 3000 RPM
Single / Double shaft extension, SPDP, IP23, IC01, B3, Class-B, S1, Solid yoke

List Of Experiments:

01. Behavior of Resistance Cut off method of starting
02. Behavior of Voltage control method of starting
03. Speed Control
04. Load test & No load test of machine
05. Speed-Torque Analysis
06. Voltage-Speed Analysis
07. Efficiency Analysis
08. Analysis of Commutation
09. Cold Resistance & Hot Resistance
10. Motor Operation parameters
11. Generator Operation parameters
12. Basic Overhauling Know how

DC Compound Machines

Order Code - 69003



DC Machines have been the running horse for the Industry since 100 Years, Compound motors are one of these types.

This Model is the Industrial/Educational model suitable for demonstrating to students the complete know of the Basics, Components, Starting methods, Wear & Tear & Maintenance of these motors packaged in small rating. Students can make connections of their own with the help of the terminations provided for study of features viz Starting methods, Speed control, Speed-Torque, Effects of Field voltage, Effects of Armature voltage, Over compound, Under compound, Motor/Generator operation.

Technical Specs :

Power ratings available : 350W / 750W / 1KW / 2 KW / 3KW/ 5KW

Voltage Input : 220V DC
Excitation : 220V DC
Armature : 220V DC
RPM : 1500 / 3000 RPM
Single / Double shaft extension, SPDP, IP23, IC01, B3, Class-B, S1, Solid yoke

List Of Experiments:

01. Behavior of Resistance Cut off method of starting
02. Behavior of Voltage control method of starting
03. Speed Control & Over speed operations
04. Load test & No load test of machine
05. Speed-Torque Analysis
06. Voltage-Speed Analysis
07. Efficiency Analysis
08. Over Compound & Under Compound Effects
09. Analysis of Commutation
10. Cold Resistance & Hot Resistance
11. Motor Operation parameters
12. Generator Operation parameters
13. Basic Overhauling Know how

3Phase AC Squirrel Cage Induction Motor

Order Code - 69004



With the availability of 3Phase power becoming common, the use of 3Phase AC Squirrel cage motor became very common & today it holds 90% of the total market share. The simplicity in operation with the 3phase voltages & immediate torque made it a very common motor.

This Model is the Industrial/Educational model suitable for demonstrating to students the complete know of the Basics, Components, Starting methods, Wear & Tear & Maintenance of these motors packaged in small rating. Students can make connections of their own with the help of the terminations provided for study of features viz Starting methods, Speed control, Speed-Torque, Effect of Phase angle, Study of Cogging/Crawling, Effects of Single phasing, Effect of voltage imbalance operation, Blocked rotor test.

Technical Specifications :

Power ratings available : 350W / 750W / 1KW / 2 KW / 3KW / 5KW

Voltage Input : 440VAC 50hz

RPM : 1440 / 2880 RPM

Single / Double shaft extension, TEFC, IP44, IC01, B3, Class-B, S1, Casting body.

List Of Experiments:

01. Starting by DOL Starter
02. Starting by Star-Delta Starter
03. Starting by reduced voltage starter
04. Speed Control by VVVF method
05. Load test & No load test of machine
06. Speed-Torque Analysis
07. Voltage-Speed Analysis
08. Speed reversal
09. Efficiency Analysis
10. Blocked rotor test
11. Cold Resistance & Hot Resistance
12. Motor Operation parameters
13. Basic Overhauling Know how

1Phase AC Squirrel Cage Induction Motor Capacitor Start

Order Code - 69005



With the availability of 3Phase power becoming common, the use of 3Phase AC Squirrel cage motor became very common & demand increased for motors with single phase power, as the current in single phase is a concern, hence motors upto 3Hp have been made In Single phase power with the same Induction design principle.

The issue of Starting of the motor with Single phase was tackled by providing Capacitor for creating phase difference. The simplicity in operation & immediate torque made it a common motor for single phase power. This Model is the Industrial/Educational model suitable for demonstrating to students the complete know of the

Basics, Components, Starting methods, Wear & Tear & Maintenance of these motors packaged in small rating. Students can make connections of their own with the help of the terminations provided for study of features viz Starting methods, Speed-Torque, Effect of Phase angle, Study of Cogging/Crawling, Effect of reduced voltage, Blocked rotor test.

Technical Specifications :

Power ratings available : 350W / 750W / 1KW / 1.5KW

Voltage Input : 230VAC 50hz

RPM : 1440 / 2880 RPM

Single / Double shaft extension, TEFC, IP44, IC01, B3, Class-B, S1, Casting/Sheet metal body

List of Experiments:

01. Starting by DOL Starter
02. Starting by reduced voltage starter
03. Load test & No load test of machine
04. Speed-Torque Analysis
05. Voltage-Speed Analysis
06. Speed reversal
07. Efficiency Analysis
08. Blocked rotor test
09. Cold Resistance & Hot Resistance
10. Motor Operation parameters
11. Basic Overhauling Know how

AC Repulsion Motor

Order Code - 69006



With the availability of 3Phase power becoming common, the use of 3Phase AC Squirrel cage motor became very common & demand increased for motors with single phase power, as the current in single phase is a concern, hence motors upto 3Hp have been made In Single phase power with the same Induction design principle.

The issue of Starting of the motor with Single phase was tackled by providing Capacitor for creating phase difference. The simplicity in operation & immediate torque made it a common motor for single phase power.

This Model is the Industrial/Educational model suitable for demonstrating to students the complete know of the Basics, Components, Starting methods, Wear & Tear & Maintenance of these motors packaged in small rating. Students can make connections of their own with the help of the terminations provided for study of features viz Starting methods, Speed-Torque, Effect of Phase angle, Study of Cogging/Crawling, Effect of reduced voltage, Blocked rotor test.

Technical Specifications :

Power ratings available : 350W / 750W / 1KW / 1.5KW

Voltage Input : 230VAC 50hz

RPM : 1440 / 2880 RPM

Single / Double shaft extension, TEFC, IP44, IC01, B3, Class-B, S1, Casting/Sheet metal body

List of Experiments:

01. Starting by DOL Starter
02. Starting by reduced voltage starter.

03. Load test & No load test of machine
04. Speed-Torque Analysis
05. Voltage-Speed Analysis
06. Speed reversal
07. Efficiency Analysis
08. Blocked rotor test
09. Cold Resistance & Hot Resistance
10. Motor Operation parameters
11. Basic Overhauling Know how

Universal Motor

Order Code - 69007



Universal motors- as the name suggests are universal because they can run on AC Supply as well as DC Supply, they belong to the family of Single phase motors with the difference that they have wound rotor, commutator & brush as used in dc motors. These motors are for intermittent duty cycles as their rpm is very high and find application in Domestic Mixer grinders & Home appliances, Industrial use is Switch yards in Power sub stations for spring charging of Circuit breakers.

This Model is the Industrial/Educational model suitable for demonstrating to students the complete know of the Basics, Components, Starting methods, Speed-Torque, Wear & Tear & Maintenance of these motors packaged in small rating.

Students can make connections of their own with the help of the terminations provided for study of features viz Starting methods, Speed-Torque, Effect of reduced voltage, Blocked rotor test.

Technical Specifications:

Power ratings available : 350W / 750W
 Voltage Input : 230VAC 50hz or 230 DC
 RPM : 6000 / 10000
 Single / Double shaft extension, SPDP, IP23, IC01, B3, Class-B, Short time duty, Solid yoke.

List Of Experiments:

01. Starting by AC DOL Starter
02. Starting by reduced AC voltage starter.
03. Starting by DC Starter
04. Speed control by DC SCR Drive
05. Load test & No load test of machine
06. Speed-Torque Analysis
07. Efficiency Analysis
08. Blocked rotor test
09. Cold Resistance & Hot Resistance
10. Motor Operation parameters
11. Basic Overhauling Know how

3 Phase Wound Rotor Slipring Motor

Order Code - 69008



Slipring motor belongs to the family of 3Phase Induction motors, with the difference that the rotor is not same as Induction motors instead has windings with slipring & slipring holder on the rotor.

These motors find major application in Crane

applications & had the advantage over induction motors that by inserting resistance in the rotor winding the speed can be varied, though this advantage is not valid today as Induction motors have go VVVF drives for speed control.

This Model is the Industrial/Educational model suitable for demonstrating to students the complete know of the Basics, Components, Starting methods, Speed-Torque behavior, Wear & Tear & Maintenance of these motors packaged in small rating.

Students can make connections of their own with the help of the terminations provided for study of features viz Starting methods, Speed control, Speed-Torque, Effect of resistance in rotor, Effects of Single phasing, Effect of voltage imbalance operation, Blocked rotor test.

Technical Specifications:

Power ratings available : 350W / 750W / 1KW / 2 KW
 / 3KW / 5KW
 Voltage Input : 440VAC 50hz
 RPM : 1440 / 2880 RPM
 Single / Double shaft extension, TEFC, IP44, IC01, B3, Class-B, S1, Casting body

List of Experiments:

01. Starting by DOL Starter
02. Starting by reduced voltage starter.
03. Speed variation by Rotor resistance
04. Speed Control by VVVF method
05. Load test & No load test of machine
06. Speed-Torque Analysis
07. Voltage-Speed Analysis
08. Speed reversal
09. Efficiency Analysis
10. Blocked rotor test
11. Cold Resistance & Hot Resistance
12. Motor Operation parameters
13. Basic Overhauling Know how

3 Phase Synchronous Machine

Order Code - 69009



Synchronous motor belongs to the family of 3Phase Induction motors, with the difference that the rotor is not same as Induction motors instead has windings with slipring & slipring holder on the rotor. These motors have damper winding to make it start like Induction motors. These motors have 2 Types of Voltage Excitation, 3Phase for starting the motor & additional 110V DC across the rotor to lock the speed of the motor- Once it is excited with DC Voltage the rpm of the motor gets locked, in the sense that if the motor is running on No load or Full load the rpm remains the same.

The application of such motors is those machines which run only on fixed speed without any rpm change, sugar mills & textile color mixing.

This Model is the Industrial/Educational model suitable for demonstrating to students the complete know of the Basics, Components, Starting methods, DC Speed locking, Speed-Torque behavior, Wear & Tear & Maintenance of these motors packaged in small rating.

Students can make connections of their own with the

help of the terminations provided for study of features viz Starting methods, Speed control, Speed-Torque, Speed locking, Effect of rotor excitation, Effect of voltage imbalance operation, Blocked rotor test.

Technical Specifications:

Power ratings available : 350W / 750W / 1KW / 2 KW / 3KW / 5KW
 Voltage Input : 440 V A C 50 h z & Additionally 110V DC for Rotor
 RPM : 1440 / 2880 RPM
 Single / Double shaft extension, SPDP, IP23, IC01, B3, Class-B, S1, Solid yoke

List of Experiments:

01. Starting by DOL Starter
02. Starting by reduced voltage starter.
03. Effect of High voltage induction at time of starting
04. DC Speed locking
05. Speed Control by VVVF method
06. Load test & No load test of machine
07. Speed-Torque Analysis
08. Voltage-Speed Analysis
09. Speed reversal
10. Efficiency Analysis
11. Blocked rotor test
12. Motor Operation
13. Generator Operation
14. Cold Resistance & Hot Resistance
15. Motor Operation parameters
16. Basic Overhauling Know how

3 Phase AC Squirrel Cage Induction Motor - Dahlander Type

Order Code - 69010



With the availability of 3Phase power becoming common, the use of 3Phase AC Squirrel cage motor became very common & today it holds 90% of the total market share. The simplicity in operation with the 3phase voltages & immediate torque made it a very common motor. Dahlander motor is just an extension with the flexibility that from 1 motor you can get 2 different fixed rpm, this is basically by changing the coil connections inside the motor.

This Model is the Industrial/Educational model suitable for demonstrating to students the complete know of the Basics, Components, Starting methods, Wear & Tear & Maintenance of these motors packaged in small rating. Students can make connections of their own with the help of the terminations provided for study of features viz Starting methods, Speed control, Speed-Torque, Effect of Phase angle, Study of Cogging/Crawling, Effects of Single phasing, Effect of voltage imbalance operation, Blocked rotor test.

Technical Specifications:

Power ratings available : 350W / 750W / 1KW / 2 KW / 3KW / 5KW
 Voltage Input : 440VAC 50hz
 RPM : 2 pole & 4 pole , (1400/2880), other

options are (6pole/4pole)
 Single / Double shaft extension, TEFC, IP44, IC01, B3, Class-B, S1, Casting body

List of Experiments:

01. Starting by DOL Starter
02. Starting by Star-Delta Starter
03. Starting by reduced voltage starter.
04. Speed Control by VVVF method
05. Load test & No load test of machine
06. Speed-Torque Analysis
07. Voltage-Speed Analysis
08. Speed reversal
09. Efficiency Analysis
10. Blocked rotor test
11. Cold Resistance & Hot Resistance
12. Motor Operation parameters
13. Basic Overhauling Know how

1 Phase AC Squirrel Cage Induction Motor Capacitor Run

Order Code - 69011



With the availability of 3Phase power becoming common, the use of 3Phase AC Squirrel cage motor became very common & demand increased for motors with single phase power, as the current in single phase is a concern, hence motors upto 3Hp have been made In Single phase power with the same Induction design principle.

These motors have a capacitor in its running winding this means the capacitor is always connected and active while the motor is running.

This Model is the Industrial/Educational model suitable for demonstrating to students the complete know of the Basics, Components, Starting methods, Wear & Tear & Maintenance of these motors packaged in small rating. Students can make connections of their own with the help of the terminations provided for study of features viz Starting methods, Speed-Torque, Effect of Phase angle, Study of Cogging/Crawling, Effect of reduced voltage, Blocked rotor test.

Technical Specifications:

Power ratings available : 350W / 750W / 1KW / 1.5KW
 Voltage Input : 230VAC 50hz
 RPM : 1440 / 2880 RPM
 Single / Double shaft extension, TEFC, IP44, IC01, B3, Class-B, S1, Casting/Sheet metal body

List of Experiments:

01. Starting by DOL Starter
02. Starting by reduced voltage starter.
03. Load test & No load test of machine
04. Speed-Torque Analysis
05. Voltage-Speed Analysis
06. Speed reversal
07. Efficiency Analysis
08. Blocked rotor test
09. Cold Resistance & Hot Resistance
10. Motor Operation parameters
11. Basic Overhauling Know how

DC Dynamometer For Motor Testing

Order Code - 69012



These Dynamometers are suitable for testing of Rotating machines AC or DC, basically these are also used as indirect method of loading of any machine.

The construction features are basically a DC Shunt Generator constructed in such a way that it is able to indicate the torque produced at the rated rpm & current for the machine coupled to it.

The prime mover becomes the motor under test & the dynamometer works as generator & its gets loaded by dissipating voltage generated in resistive load bank.

This Model is the Industrial/Educational model suitable for demonstrating to students the complete know of the Basics, Components, Mechanicals, Loading methods, Torque evaluation, Loading scheme, Wear & Tear & Maintenance of these motors packaged in small rating. Students can make connections of their own with the help of the terminations provided for study of features viz Coupling the motor to be tested, Starting methods, Speed-Torque, Excitation control of Dynamometer, Power dissipation of Generator, Torque measurement.

Technical Specifications:

Power ratings available : 1KW / 2KW/ 5KW/ 10KW
 Voltage Input : 230V DC
 RPM : 1440 / 2880 RPM
 Single / Double shaft extension, SPDP, IP23, IC01, B3, Class-B, S1, Solid yoke

List of Experiments :

01. Load testing of AC Motor
02. Load testing of DC Motor
03. Torque calculation at various rpm
04. Speed-Torque Analysis
05. Voltage-Speed Analysis
06. Speed reversal
07. Efficiency Analysis
08. Blocked rotor test
09. Cold Resistance & Hot Resistance
10. Motor Operation parameters
11. Basic Overhauling Know how

Split Phase AC Motor

Order Code - 69015



These motors belong to the Single phase motor family, but these do not have capacitors to provide the initial turning effect, and hence have a very low starting torque.

This Model is the Industrial/Educational model suitable for demonstrating to students the complete know of the Basics, Starting method, Winding study, Study of Speed-Torque, Study of Efficiency & Maintenance of these motors packaged in small rating.

Students can make connections of their own with the help of the terminations provided.

Technical Specifications:

Power ratings available : 1KW / 2KW
 Voltage Input : 230VAC 1Phase 50Hz
 1500 rpm, TEFC, B3, IP44, IC01, Class-B, S1, Single / Double shaft extension

List of Experiments:

01. Starting by DOL Starter
02. Starting by reduced voltage starter.
03. Load test & No load test of machine
04. Speed-Torque Analysis
05. Voltage-Speed Analysis
06. Efficiency Analysis
07. Blocked rotor test
08. Cold Resistance & Hot Resistance
09. Motor Operation parameters
10. Basic Overhauling Know how

Single Phase Transformer

Order Code - 69016



Transformers are Basically Power conversion Devices, converting One voltage level to another starting from the Power generation stage till the Power utilization level.

Single Phase transformer as the name suggests has Primary 230VAC & Secondary has tapings at 100%, 60%, 33% etc for various experiments.

This Model is the Industrial/Educational model suitable for demonstrating to students the complete know of the Basics, Study and Voltage conversion at various levels, Study of Efficiency & Maintenance of these Transformers packaged in small rating. Students can make connections of their own with the help of the terminations provided.

Technical Specifications :

Power ratings available : 1KVA / 2KVA / 5 KVA
 Voltage Primary : 230VAC
 Voltage Secondary : 115VAC with tapings
 Enclosed in cabinet with terminations on Bakelite sheet with Banana terminals

List of Experiments:

01. Study of No load
02. Study of Full load
03. Efficiency evaluation
04. Study of losses in transformer
05. Basic Overhauling Know how

Three Phase Transformer

Order Code - 69017



Transformers are Basically Power conversion Devices, converting One voltage level to another starting from the Power generation stage till the Power utilization level.

Three Phase transformers as the name suggests has

Primary 440VAC & Secondary has 230v AC 3Phase, Various connects are possible Star-Star, Delta-Delta with the connections provided for various experiments. This Model is the Industrial/Educational model suitable for demonstrating to students the complete know of the Basics, Study and Voltage conversion at various levels, Study of Efficiency & Maintenance of these Transformers packaged in small rating. Students can make connections of their own with the help of the terminations provided.

Technical Specifications:

Power ratings available : 1KVA / 2KVA / 5 KVA / 10KVA
 Voltage Primary : 440VAC
 Voltage Secondary : 230VAC
 Enclosed in cabinet with terminations

List of Experiments:

01. Study of No load
02. Study of Full load
03. Vector group connections
04. Efficiency evaluation
05. Study of losses in transformer
06. Basic Overhauling Know how

Alternators

Order Code - 69018



Alternators are the Power Generation Devices, converting mechanical energy into Electrical Energy, The electricity provided by our utilities is from some Power Generation center where an Heavy Alternator is the device producing Electricity . Alternators have a design with wound rotor & wound stator, Alternators available are with slipping holders & also Brushless types. Students can make connections of their own with the help of the terminations provided for study of features viz Single phase generation, 3Phase Generation, Regulation with change in Load, Effect of change of speed on output voltage, Effects of Field voltage excitation change.

Technical Specifications:

Power ratings available : 350W / 750W / 1KW / 2 KW / 3KW / 5KW
 Voltage output : 220/440VAC
 Separate/Self Excitation : 220V DC
 RPM : 1500 / 3000 RPM
 Single / Double shaft extension, SPDP, IP23, IC01, B3, Class-B, S1, Solid yoke

List of Experiments:

01. Regulation of Alternator
02. Effect of change of Speed on Output voltage
03. Change of Voltage with Excitation control
04. Voltage-Speed Analysis
05. Efficiency Analysis
06. Cold Resistance & Hot Resistance
07. Alternator parameters
08. Basic Overhauling Know how

Capacitive Load Bank

Order Code - 69020



Voltage utilized in industry are of either Resistive, Inductive or Capacitive types these provide various types of power factor and the power system behaves accordingly. Capacitive load banks are used to provide leading power factor in any power system, normally all industrial units have lagging power factor & hence utilize capacitive load banks for getting leading power factor which compensates with the lagging power factor & makes the power system work near unity, this reduces the reactive power of the system improving the overall efficiency. Capacitors are arranged in various combinations in each phase to provide balanced capacitance per phase. This Model is the Industrial/Educational model suitable for demonstrating to students the complete know of the Basics, Change of capacitance in steps, Study of Efficiency & Maintenance of these Loads packaged in small rating. Students can make connections of their own with the help of the terminations provided.

Technical Specifications:

Power ratings available : 1KW / 2KW / 5 KW / 10KW
 Voltage Primary : 440VAC 3Phase/ 220VAC
 Single phase

Enclosed in cabinet with Steps provided for loading, meters provided for each phase & terminations brought out on Banana terminals

List Of Experiments:

01. Calculation of total capacitance
02. Effect of capacitance on power system
03. Capacitive load provided for Alternators & Generators
04. Efficiency evaluation
05. Study of losses
06. Basic Overhauling Know how

Inductive Load Bank

Order Code - 69021



Voltage utilized in industry are of either Resistive, Inductive or Capacitive types these provide various types of power factor and the power system behaves accordingly. Inductive load banks provide lagging power factor, these are made by a 3phase core & with the help of wheel the Inductance is increased or decreased, each phase. These are used to simulate industrial loads which are mostly lagging in nature. This Model is the Industrial/Educational model suitable for demonstrating to students the complete know of the Basics, Change of Inductance measured in henry, Study of Efficiency & Maintenance of these Loads packaged in small rating. Students can make connections of their own with the help of the terminations provided.

Technical Specifications :

Power ratings available : 1KVA / 2KVA / 5 KVA /

Voltage Primary : 10KVA
: 440VAC 3Phase/ 220VAC
Single phase

Enclosed in cabinet with Wheel provided for loading/unloading, meters provided for each phase & terminations brought out on Banana terminals

List of Experiments:

01. Calculation of total Inductance in Henry
02. Effect of Inductance on power system
03. Inductive load provided for Alternators & Generators
04. Efficiency evaluation
05. Study of losses
06. Basic Overhauling Know how

Electrical Machine Trainer

Order Code - 69025



Electrical Machine tutor/trainer is a CKD (Complete Knocked Down) kit for building various types of machines. It is useful for construction of 23 types of different Electrical Machines.

It is useful in giving student confidence & understanding constructional details & functional characteristics of electrical machines. The experience achieved by students, by themselves assembling various components viz, Armature, Stator, Slipring, Caron, Rocker, Shaft, Pulley, Belt, Dial,..Assembling all components, Fitting & tightening, Connecting with Panel & Starting the system with desired results--this gets confidence in students & the feel of Industrial products.

Machine Trainer:

Specification of 1HP Electric Machine trainer is given ahead. Electric Machine Trainer is suitable for demonstrating the construction & working of DC Motor/DC Generator (Shunt, series & compound) with Interpole, Single phase capacitor run motor, 3Phase Induction motor, (Sq. cage & Slipring), AC Alternator (Single/Three Phase), Single phase universal & repulsion motor, AC Synchronous Generator. Set will be provided with metering panel, power supply panel, for 3Phase & Single phase supply, DC Rectifier panel for DC Motor & DC/AC Single phase variable supply source complete with common base frame & friction bracket dynamometer. Rating of DC Prime mover will be 1HP, 220V, 3000RPM, & other rating will be according to requirement.

Assemblies:

01. DC MACHINES

- * DC Shunt motor without Interpole
- * DC Shunt motor with Interpole
- * DC Series motor without Interpole
- * DC Series motor with Interpole
- * DC Compound motor without Interpole
- * DC Compound motor with Interpole
- * DC Shunt Generator without Interpole
- * DC Shunt Generator with Interpole
- * DC Series Generator without Interpole
- * DC Series Generator with Interpole

- * DC Compound Generator without Interpole
- * DC Compound Generator with Interpole
- * DC Separately excited Generator without Interpole
- * DC Separately excited Generator with Interpole

02. AC MACHINES (Single Phase)

- * Single Phase 4 Pole, Induction motor Capacitor Start/Run.
- * Single Phase AC Series motor.
- * Single Phase AC Generator Rotating Field
- * Single Phase AC Generator Rotating Armature.
- * Single Phase Universal motor.

03. AC MACHINES (Three Phase)

- * AC 3 Phase Induction motor Squirrel cage type.
- * AC 3 Phase Induction motor Slipring type.
- * AC 3 Phase Generator Rotating field type.
- * AC 3 Phase Generator Rotating Armature type.
- * AC 3 Phase Synchronous Generator Rotating field type..
- * This is the Basic model, Advanced models are available on request with a wide range of Advanced Machines & Drives as per your request.

DC Starters (Resistance Cut off Starters)

Order Code - 69026



DC Motors cannot be started directly with the applied voltage as the back emf is very low hence very heavy current flows in the motor, to reduce the inflow of current resistance is inserted in series with the motor armature & once the motor starts rotating the resistances are gradually cut off.

This concept of starting of DC Motors has 3 Basic types of DC Starters

- 2Point DC Starter for DC Series motors
- 3Point DC Starter for DC Shunt motor
- 4Point DC Starter for DC Compound motor

Technical Specifications:

Power ratings available : 350W / 750W / 1KW / 2 KW
/ 3KW/ 5KW
Voltage Input : 220V DC

List of Experiments:

01. DC Series motor starting with 2Point DC Starter
02. DC Shunt motor starting with 3Point DC Starter
03. DC Compound motor starting with 4Point DC Starter
04. Educational type with components visible
05. Basic Overhauling Know how

Variable DC Power Source / Power Distribution Panel

Order Code - 69027



Performance Specification For Static Converter

01. SCOPE: Our specification covers design, manufacturing, inspection, testing, supply of the DRIVE.

02. INPUT SYSTEM:

Normal Voltage	: 415V +/- 10%
No of phases	: Three phase, four wire
Frequency	: 50Hz +/- 2%
Fault level	: 20KA RMS at 415 V.
Neutral earth	: Solidly earthed.

03. TECHNICAL PARTICULARS :

- * Output Voltage.

Armature	: 440V DC Max.
Field	: 220V DC
DC Motor Blower	: 415V +/-10%, 50Hz +/- 2%, 3Ph.
- * Output Current.

Armature :	
Field :	
- * **Speed Control.**
- * Accuracy of speed control. +/-2% under Arm. Voltage feedback.
- * Soft start. Acceleration and deceleration control from 5sec to 30sec adjustable.
- * Type of control : Tacho/Arm. Voltage feedback.
- * Direction of rotation.:
- * Braking.
- * Type of cooling : Forced air cooling

04. CONVERTER MODULES.

It consists of the following modules.

- * Input module
- * Thyristor module
- * Regulation module
- * Output module
- * Excitation module
- * Indicating and operating module
- * Protection module

4.1 Input module

The incoming 415V 3PH four wire supply will be brought into this module. It consists of

- * Tripple pole and neutral incoming AC heavy duty isolator switch.
- * Three nos. HRC fuse link for mains.
- * Main contactor
- * Line surge suppressor consisting of capacitors, resistors & MOVs.

4.2 Thyristor module

It will consist of three phase, full wave, fully controlled thyristor bridge assembly comprising of

- * Six nos. derated thyristors each mounted on Aluminium heat sinks
- * RC Snubber circuit for power semi-conductors.
- * MOVs to protect thyristors against spikes.
- * Pulse transformers to isolate the control circuit from power circuit.
- * Forced cooling arrangement.

4.3 Regulation module

It consists of modular glass-epoxy based printed circuit boards of height 4U with plug-in type gold plated connectors for easy replacement and servicing.

These are green masked, legend printed PCBs housed in a card frame and interconnected by a mother PC Board.

The different blocks are as under.

- * Power supply and regulator.
- * Ramp generator with adjustable accn. Decn.

Circuit.

- * Voltage and current control amplifier which controls the output voltage with adjustable voltage and current limiting.
- * Pulse amplifier feeding the pulse transformer primary and the gate trigger circuits.
- * Tripping circuit for single phasing, phase sequence, under voltage, field failure and Electronic overload. The settings petentiometers (presets), coloured test points and LED indicators are located at the front of the cards.

4.4 Output module

It consists of a shunt for DC Ammeter and current feedback components.

4.5 Excitation module

This module consists of the following

- * Step down transformer 415/220V
- * Link type HRC fuses.
- * Single phase full wave diode bridge.

4.6 Indicating and operating module.

It consists of operational controls

- * Start push button
- * Stop push button
- * Emergency stop push button.
- * Set speed potentiometer.
- * Fault Reset push button
- * Mains ON Indicator
- * Motor ON indicator
- * Drive tripped
- * DC Voltmeter for Armature
- * DC Ammeter for Armature
- * Motor RPM Indicator
- * AC Voltmeter with selector switch for mains supply.

4.7 Protection module

This module protects the Drive against various faults...

- * MOVs (Metal Oxide Variastors) for mains voltage spikes.
- * Electronic Overload for DC Motor.
- * Bimetallic thermal overload relay for DC Motor blower.
- * Bimetallic thermal overload relay for Converter blower (if used)
- * Electronic instantaneous overcurrent trip.
- * Single phasing or negative sequence trip which blocks the gate triggering pulses to the thyristors.
- * Electronic current sensing type field failure protection.

HIGHLIGHTS OF SYSTEMS.**01. Protectional features.**

- * Single phasing. If one of the line voltages is absent the load is shared by the other two lines and the corresponding thyristors get overloaded. To prevent this, single phasing preventor trips the main contactor.
- * Phase reversal. If the incoming mains are not connected in proper sequence the main contactor cannot be switched on.
- * Soft start features. The system will consist of soft start, so that on giving the 'start' command the motor builds up to the set speed gradually. The rate of acceleration is adjustable. In case of step changes, the overshoot will not exceed 8% of the rated speed.
- * Surge suppression. The system devices will be protected against line surges and switching surges by RC noise suppression networks.

- * dv/dt protection. To avoid accidental triggering of the thyristors due to high dv/dt, RC snubber circuits are provided across each thyristor. These are properly designed so as to limit dv/dt rating to less than 200 volts per sec.
- * di/dt protection. A.C line chokes are connected in series with the supply lines connected to the thyristor bridge. These chokes limit the maximum di/dt rating to 50Amp. Per sec.
- * Peak inverse voltage. The power semiconductor devices will be so selected that their PIV rating will be 2.5 times the normal voltage.
- * Blocking of pulses. In the event of fault, the pulse to the converter thyristors will be blocked. There is no transfer of power from a.c mains to motor and motor eventually stops.

02. Rating of Resistors. The wattage of the resistors used will be such that their temperature will not exceed 100deg C. The high wattage types will be wirewound on rigid cylinder of ceramic material. Potentiometer will be single turn, wirewound for high stability giving reliable contact between the moving arm and wire track.

03. Temperature rise. The large heat sinks and proper ventilation are provided so that the junction temperature of power semi-conductor devices do not exceed the permissible limits.

04. Printed Circuit boards. It will be made of 1.6mm thick glass-epoxy, copper clad laminates having 35 micron thick copper. The copper tracks will be tin plated & green masked. PCBs will be coated on both sides with anti-corrosive solderable protective lacquer. Suitable test points and indications will be provided on the PCB.

05. Component Selection. All components mounted on PCB will be mostly defence approved to ensure reliability. Cores of transformers and chokes will be made of CRGO Laminations. The copper conductors will be of low loss and electrolytic grade copper. Contactors and circuit breakers will be of reputed make.

06. Workmanship. The component layout will be such that it will facilitate easy maintenance. The interconnections will be made by cables and wires routed through PVC channels. All cables and wires will be ferruled in accordance with wiring diagrams. All the components will have suitable identification tags. Terminal strip diagram will be provided inside the panel.

07. Earthing and insulation. Power earth terminals in effective contact with the cubicle frame-work will be provided outside the panel.

These can be suitably connected to the external earth conductors. All metal parts that do not carry currents will be electrically connected to earth. The insulation resistance will be not less than 10Mohms, when measured at 50volts DC between

- * AC input terminals of thyristor control drive and earth.
- * DC output terminals of unit to armature and earth.
- * DC output terminals of unit to field and earth.
- * AC output terminals of unit to blower motor and earth.

GENERAL SPECIFICATIONS FOR DRIVE SYSTEMS

01. Reference standard

- * Design, manufacture and testing of Static converter as per the latest applicable Indian

standard or equivalent.

- * IS 1885 (part XXVII) : Static power Converter.
- IS 1885 (part VII) : Thyristor.
- IS 4253 : General requirement for switchgear & control gear for voltage not exceeding 1000 volts
- IS 2959 : Specification for Current transformers.
- IS 1243 : Specification for electrical indicating instruments.
- IS 220 : HRS Fuse links upto 650volts
- IS 591 : Transformers for electronic components.
- * Our static converter will also conform to the requirement of the latest Indian Electricity rules or equivalents.

02. Site conditions.

Drive systems are designed for conditions operation under the following site conditions.

- * Altitude : less than 1000 mts. From MSL.
- * Maximum relative humidity : 67%
- * Ambient temperature : 50degC. (maximum)
- * Atmospheric conditions : dusty.
- * Installation : indoor.

03. Drive systems are designed for the following load conditions.

- * 100% load for continuous operation (24 hrs. per day)
- * 125% load for 2 hrs.
- * 200% for 60sec.

04. System Design

Static Converters are designed for the speed regulation of +/- 0.1% of base speed under tachofeedback. The system will also be designed to operate under following conditions.

- * 100% change in load.
- * +/- 10% variation in supply voltage.
- * +/-2% variation in supply frequency.

05. Execution

The different components of the system will be housed in a cabinet which will be either floor mounting or wall mounting. The cabinet will be fabricated from M.S. sheet of 16 or 14 guage. The frame will be fabricated from 2mm. thick cold rolled sheet steel. The arrangement of different components inside the panel will be logical and various sections will be easily accessible for inspection and maintenance.

06. Painting and Finishing

All sheet Steel fabrication work will be thoroughly cleaned. It will undergo a treatment of degreasing and pickling before giving the prime coats. The prime will consist of one coat of epoxy based anticorrosive primer paint. The panels will be finished with two coats of synthetic enamel paint.

07. Cabling

We will provide cable entries at the bottom of the panel for incoming and outgoing power and control cables. The cables will be of sufficient size to carry the required electrical power.

8. Terminals

All power connections will be terminated on stud power terminals with spring washers and locknuts. For Control

terminals in each module terminal blocks of suitable ratings will be provided. The PCBs terminals will be of easily removable but reliable contact type. The blower motor connections and field wires will be terminated on 16Amps. rated terminal blocks.

9. Wiring

Internal wiring of the Thyristor control panel will be carried out with 650/1000 grade PVC insulated copper wires and cables will be provided with ferrules having numbers printed on it.

10. Name Plate

All the main components inside the panel will be provided with proper plates for quickly locating their positions. All the front mounted equipments will be provided with individual labels.

11. Earthing

The Control panel will be provided with two external earthing terminals complete with plain and spring washers suitable for connecting main earth.

12. Spares.

We will furnish a list of recommended spares to cover two years of trouble free operation.

13. Inspection and testing

We offer 'no load' test at our works for the panel prior to dispatch.

14. User handbook

We furnish one set of user handbook consisting of installation, operation fault finding chart and bill of material along with the respective drawings.

15. Guarantee.

The Drive is guaranteed against manufacturing defects for a period of 18months from the date of dispatch or 21months from the date of commissioning whichever is earlier.

Electrical Machine Trainer

Order Code - 69033



The Electrical Machine Trainer system is provided with specially designed integrated machines of nominal 300 W / 0.5 HP rating. Control Panels containing power supplies, drives, loading arrangements, electronic and digital instruments are provided along with Machines. The training system is suitable to study a wide range of electrical machine syllabi starting from the basic principle and operation to the detailed study of characteristics of different types of AC and DC Machines

This Machine Trainer consists of the following Machine and Control Panel Sets:-

Machine Set - 1

0.5 HP / 180 V / 1500 RPM / DC Integrated Machine, Coupled with 350 VA / 3 Phase / 415 V / 1500 RPM / Star connected / Rotor Wound / Stator Excited / 220 V DC Separate excitation / Manually regulated / 3 Phase Synchronous Machine with Damper winding. Provided

with base and couplings. DC Machine will be Trunnion Mounted Dynamometer type with Linear scales (2 nos.) for torque measurement. DC Machine can run as DC Shunt, Series & Compound Motor as well as Generator. 3 Phase Synchronous machine can run as 3 Phase Synchronous Alternator & 3 Phase Auto Synchronous Motor

Machine Set - 2

0.5 HP / 415 V Stator / 200 V Star connected Rotor / 1440 RPM / 3 Phase / Slip Ring Induction Motor complete with Mechanical Loading Arrangement having Aluminum Drum Mounted on Motor Shaft, Linear spring balances (2 nos.), Friction belt & necessary frame work for Torque Measurement

Machine Set - 3

0.5 HP / 415 V / 1440 2880 RPM / 3 Phase / SQ. Cage Induction Motor with Dhalandar Winding for 2 speed operation. Complete with Mechanical Loading Arrangement having Aluminum Drum Mounted on Motor Shaft, Linear spring balances (2 nos.), Friction belt & necessary frame work for Torque Measurement

Machine Set - 4

0.5 HP / 230 V / 1 Phase / 1440 RPM / SQ. cage Induction Integrated Motor. Complete with Mechanical Loading Arrangement having Aluminum Drum Mounted on Motor Shaft, Linear spring balances (2 nos.), Friction belt & necessary frame work for Torque Measurement. This Motor can run as Capacitor Start Capacitor Run (CSCR), Capacitor Start Induction Run (CSIR) and Split Phase Single Phase Sq. Cage Induction Motor

Machine Set - 5

0.5 HP / 160 V DC 220 V AC / 1500 2000 RPM / Universal (AC Series) Motor. Complete with Mechanical Loading Arrangement having Aluminum Drum Mounted on Motor Shaft, Linear spring balances (2 nos.), Friction belt & necessary frame work for Torque Measurement

Machine Set - 6

0.5 HP / 230 V AC / 1500 RPM / Repulsion Motor Complete with Mechanical Loading Arrangement having Aluminum Drum Mounted on Motor Shaft, Linear spring balances (2 nos.), Friction belt & necessary frame work for Torque Measurement

Control Panel (Common for all Machine sets) Control Panel is made of 16 SWG SS Sheet metal with Poly Carbonate Facia displaying Mimic diagrams. The Control Panel will consist of the following components:-

- Digital DC Ammeters 3 Nos
- Digital AC Ammeter
- Digital DC Voltmeters 3 Nos
- Digital AC Voltmeter
- 3 Phase / 1E AC Combimeter
- Digital RPM Indicator with sensor
- Single Phase DC Thyristor Power Supply 3 Nos
- 1 Phase Resistive Load Bank
- 3 Phase Resistive Load Bank
- DOL cum Star Delta starter
- DC Starter
- Field Regulator
- Fix resistance as Field Diverter
- 3 Phase Variac (External) and all other required Indicators, switches, MCB & Educational Type terminals

Note: Individual Control panels for each machine set

can be provided at an extra cost to facilitate multiple student batches to perform experiments simultaneously

Salient features:

- Control Panel contains all safety and tripping measures
- Panel has Polycarbonate Facia with mimic diagrams of components with all terminals brought outside for easy and shock free connections
- The trainer unit covers a wide range of machine syllabus. More than 45 experiments can be conducted
- Easy and safe wiring due to use of colour coded & Electrically insulated terminals (binding posts) on Top
- Dynamically balanced rotors to minimise vibration / noise
- Acrylic viewing window is provided to observe internal structure of machine and to make students familiar with parts of the machines like commutator, slip ring, brush holder, carbon brush, stator, rotor, centrifugal switch etc
- Digital indication of electrical parameters like Voltage, Current, RPM, etc. giving a broad introduction of measuring instruments
- Separates Machines with Common Control Panel of option for individual Control Panels which enables multiple batches of students to conduct experiments simultaneously
- Performance conforming to IS/IES Standards
- Complete Hard and Soft copy of Manual

List of Practicals that can be covered by Electrical Trainer Unit At a glance DC Integrated Machine

- Speed torque characteristic for self/separately excited Shunt Motor
- Speed torque characteristic for over/under/level excited compound Motor
- Speed torque characteristic for Series Motor
- Study of cumulative and differential compounded motor
- Swinburne's test on DC Machine
- Starting methods of DC Machine using 2P/3P/4P Starters
- Speed control of Shunt Motor using armature/field control
- Speed control of Compound Motor using armature/field control
- Speed control of Series Motor using armature control
- O.C.C on DC Generator
- V/I characteristic for separately/self excited DC shunt Generator
- V/I characteristic for over/under/level excited Compound Generator
- V/I characteristic for Series Generator
- Study of cumulative and differential compounded Generator
- Efficiency curve for DC integrated Machine
- Study of a Dynamometer

3 Phase AC Synchronous Machine

- Load characteristic of 3 phase Synchronous Motor
- V curve/inverse V curve for 3 phase synchronous machine
- Current Locus for Synchronous Motor
- Voltage regulation of Three Phase Alternator by

EMF, MMF & Direct Loading (UPF)

- Load characteristic of 3 phase Alternator
- O.C.C/S.C.C. test for 3 phase Alternator
- Slip test for 3 Phase Synchronous machine
- Efficiency curve 3 Phase Alternator and synchronous Motor Universal Motor
- Load test of Universal Motor with AC supply
- Load test of Universal Motor with DC supply
- Speed control of Universal Motor
- Efficiency curve for Universal Motor

1 Phase AC Integrated Machine

- Load characteristic of 1 Phase AC Motor as capacitor start-induction run
- Load characteristic of 1 Phase AC Motor as capacitor start-capacitor run
- Load characteristic of 1 Phase AC Motor as split phase
- Blocked rotor Test
- Efficiency curve for 1 phase AC Induction Motor
- 3 Phase AC Integrated Machine
- Load characteristic of 3 Phase Slip Ring Induction Motor
- Star/Delta starting of 3 Phase Slip Ring Induction Motor
- DOL starting of 3 Phase Slip Ring Induction Motor
- Load characteristic of 3 Phase self start Synchronous Induction Motor
- Blocked rotor test
- Efficiency curve for 3 phase Slip Ring Induction Motor
- Repulsion Motor
- Load test of Repulsion Motor
- Speed control of Repulsion Motor. (with Brush Adjustment)
- Efficiency curve for Repulsion Motor

3 Phase Sq. Cage Induction Motor

- Load characteristic of 3 phase SQIM @ 2 Pole & 4 Pole
- DOL starting of 3 phase SQIM
- Blocked rotor test
- Efficiency curve for 3 phase SQIM
- To study Dhalandar Winding. (2 Pole 4 Pole connection) MG Set
- 3 phase AC to DC converter & vice versa

Technical Specification:

Common Specifications

- Frame : 90 /100 Watts : 300/375 RPM : 1500
- Insulation Class : B Enclosure : SPDP /IP22 Duty : S1 (Continuous)
- Cooling : IC01 Mounting : B3 (Foot) Hz. : 50 (if AC)

DC Integrated Machine

- Field V : 180 Field A : 0.45
- Armature V/A For Motor : 180 V / 2 A
- Shunt Generator : 170 V / 1.75 A
- Series Generator : 120 V / 2.5 A
- Compound Generator : 190 V / 1.6 A

3 Phase Synchronous Machine

- ROTOR : 415 V / 0.6 A / 3 Phase 4 WAC
- Star Connection
- Stator : 220 V / 0.5 A DC

Single Phase AC Integrated Machine

- Volts : 230 Hz : 50
- AMPS : CSCR : 2.6 A CSIR : 4.7 A

- Split Phase : 4.7 A

Three Phase AC SQIM (2 Speed)

- With Dhalandar Winding
- Hz : 50 VOLTS : 415
- 0.5 HP AMPS : 1.0 RPM : 1500
- HPAMPS : 2.0 RPM : 3000

Repulsion Motor

- AC
- Volts 230
- AMPS 4.5

Three Phase AC Slipring Machine

- Hz : 50 CONN : Delta
- SYN. Induction
- SLIM Motor
- V (Stator) 415 VAC 415 VAC
- A (Stator) 1.4 A AC 0.8 A AC
- EX. V (Stator) 50 V DC 50 V DC
- EX. A (Stator) 2.0 A DC 2.0 A DC

Universal Motor

- AC DC
- Volts 230 150
- AMPS 4.5 3.5
- RPM 2000 1500

Electrical Workshop Lab Panels

Order Code - 69501 To 69532

INDEX

SN.	Item Name	Order Code
01	Single Phase Power Supply	69501
02	Switches and Commutator	69502
03	Intermediate Switch	69503
04	Intermediate Switch and Two-Way Switches	69504
05	Light Push Button	69505
06	Bell/Door Opener Push Buttons	69506
07	Maid/Valet/Port ER Push Buttons	69507
08	Universal Socket	69508
09	Halogen Lamps	69509
10	Low Consumption Fluorescent lamps	69510
11	Single phase Transformer	69511
12	Latching Relay	69512
13	Ming Relay	69513
14	Incandescent and Fluorescent lamps	69514
15	Bells	69515
16	Bell and Buzzer	69516
17	Power Supply	69517
18	Emergency Push Button	69518
19	Alarms	69519
20	Signalling Lamps	69520
21	Twilight Switch	69521
22	Timer Switch	69522
23	Three Phase Power Supply	69523
24	Single Phase Transformer	69524
25	Emergency Push Button	69525
26	Three Push Button	69526
27	Three Pilot Lamps	69527
28	Contacto	69528
29	Time Relay	69529
30	Thermal Relay	69530
31	Three Phase Induction Motor	69531
32	Three Pole Switch	69532

SINGLE PHASE POWER SUPPLY - 69501

Single Phase Power Supply is designed to familiarize students with various methods of protection of power circuits. It has been made with safety and protection in mind and with strong insulation.



Procedure:

01. Connect the Input AC Voltage at Input Terminal
02. Switch ON the Two Pole MCB
03. Turn the key lock switch
04. Check the light indication
05. Observe the Output at Output Terminal

SWITCH AND COMMUTATOR - 69502

Switch modules come in a wide variety and are designed to familiarize students with various methods of switching voltages, currents and loads.



They have been made with safety and protection in mind and with strong insulation.

01. Left side Both the Terminal are internally connected with Left switch
02. Right side Both the Terminal are internally connected with the Right switch
03. When the switch is 'ON' than both the contact to terminal are connect.
04. When the switch is 'OFF' than both the contact to terminal are disconnect.

INTERMEDIATE SWITCH - 69503

Switch modules come in a wide variety and are designed to familiarize students with various methods of switching voltages, currents and loads.



They have been made with safety and protection in mind and with strong insulation.

An intermediate switch is used to control something from more than one location. The modules is provided with one switch. The intermediate switch is used where 3 or more switch control one light at a time

INTERMEDIATE SWITCH AND TWO-WAY SWITCHES - 69504

Switch modules come in a wide variety and are designed to familiarize students with various methods of switching voltages, currents and loads.



They have been made with safety and protection in mind and with strong insulation.

This allows a single light to be turned on or off from and of the switches. The module is provided with 2 two way switches, and, one intermediate switch.

01. Make the connection as per connection diagram
02. Use the intermediate switch as per desired output in the circuit.

LIGHT PUSH BUTTON - 69505

Switch modules come in a wide variety and are designed to familiarize students with various methods of switching voltages, currents and loads.



They have been made with safety and protection in mind and with strong insulation.

Light Push Button switch is a switch most commonly used to operate electric lights, permanently

connected equipment, or electrical outlets. This module is provided with a single pole switch.

01. When we push the switch then both the contact of terminal are Connect.

BELL / DOOR OPENER PUSH BUTTONS - 69506

Switch modules come in a wide variety and are designed to familiarize students with various methods of switching voltages, currents and loads.

They have been made with safety and protection in mind and with strong insulation. This module is supplied with 2 switches



- 01 When we push the right side button than make / connect the contact of right side terminal
- 02 When we push the Left side button than make / connect the contact of Left side terminal

MAID / VALET / PORTER PUSH BUTTONS - 69507

Switch modules come in a wide variety and are designed to familiarize students with various methods of switching voltages, currents and loads.

They have been made with safety and protection in mind and with strong insulation. The maid / valet / porter module is supplied with 3 single pole push button switches.



- 01. Contact of the Right side terminal are connected to right side switch
- 02. Contact of the Middle terminal are connected to Middle switch
- 03. Contact of the Left side terminal are connected to Left side switch
- 04. When we push the switch than contact of terminal are connect

UNIVERSAL SOCKET - 69508

Universal Socket is meant to be used for different types of plugs. They have been made with safety and protection in mind and with strong insulation. Safety Terminal and insulated panels are used throughout.

The socket has a earth contact also. Can be used for the following types of plugs:



- 01. Each Terminal are connect with respect to Neutral, Phase, Ground of the socket.
- 02. Green Terminal are indicated as a ground
- 03. Red Terminal are indicated as a Phase
- 04. Black Terminal are indicate as a Neutral

HALOGEN LAMPS - 69509

Halogen lamp is an incandescent lamp that has a small amount of a halogen. produces light temperature. The module has two halogen lamps and has been made with safety and protection in mind and with strong insulation



- 01. Connect the 230AC input at input terminal
- 02. connect the 12V output to any one lamp input
- 03. See the effect of respected lamp is glow

Note:- Use any one lamp at a time

LOW CONSUMPTION FLUORESCENT LAMPS - 69510

Low consumption fluorescent lamp is a A compact

fluorescent lamp (CFL) is a fluorescent lamp designed to replace an incandescent lamp; some types fit into light fixtures formerly used for incandescent lamps.

The lamps use a tube which is curved or folded to fit into the space of an incandescent bulb, and compact electronic ballast in the base of the lamp. The module has two low consumption fluorescent lamps . The module has been made with safety and protection in mind and with strong insulation..



- 01. Connect the CFL at CFL Holder
- 02. Apply the 230V AC at input terminal
- 03. Switch ON the 230V AC Supply
- 04. Check the CFL is glow with respect to input voltage

SINGLE PHASE TRANSFORMER - 69511

Single Phase Transformer is meant to step down the voltage at the secondary side. This module has the one transformer in which two different input voltage range. We apply only one input at a time and observe the center tap output. For protection we use the primary fuse 600 mA The module has been made with safety and protection in mind and with strong insulation.



- 01. Apply the 230VAC input at input terminal
- 02. Check the output at secondary 12-0-12 Volt at 2.21Amp / 50VA

LATCHING RELAY - 69512

Latching Relay works with the use of two coils. These coils control the relay. It generates a magnetic field. As the circuit generates electricity, the switch pushes from one side to the other. The module has two relays with bistable operating contacts. They have been made with safety and protection in mind and are ruggedly built with strong insulation. Safety Terminal and insulated panels are used throughout.



- 01. Apply input 24V AC at input terminal
- 02. Initially One relay is on condition than
- 03. Press the set switch than change the position of relay is off condition and other (second) relay is on condition
- 04. Again press the reset switch than change the position of above relay

MING RELAY - 69513

Ming relay has an automatic staircase lighting control switch with adjustable or continuous timing. The module has been made with safety And protection in mind and is ruggedly built with strong insulation. Safety Terminal and insulated panels are used throughout.



- 01. Apply input 230V AC at input terminal
- 02. Put load across terminal bulb/etc.

INCANDESCENT AND FLUORESCENT LAMPS 69514

The Incandescent light appears yellowish compared to fluorescent light as incandescent lamps produce light from heat. The fluorescent lamp is a low pressure

mercury-vapour gas-discharge lamp that uses fluorescence to produce visible light. The module has two incandescent lamps and one fluorescent lamp with starter. The module has been made with safety and protection in mind and strong insulation.



01. Apply the input AC 220V at input (L-N)
02. Check the incandescent lamp is glow
03. Make the circuit as connection diagram

BELLS - 69515

A doorbell is a signaling device typically placed near an entry point. When a switch is pressed the bell rings. bells module has two bells and has been made with safety and protection in mind and with strong insulation.



01. Apply input at input terminal
02. Switch ON the any one switch than BELL is working condition and here the BELL sound.

BELL AND BUZZER - 69516

Bell & Buzzer module has one bell switch and one buzzer switch. These are Low-voltage hardwired push button switches. The module has been made with safety and protection in mind and with strong insulation.



01. Apply the input 230V AC at input terminal
02. Switch ON the first switch than BELL is working condition and here the sound of BELL
03. Switch ON the second switch than Buzzer is working condition and here the sound of Buzzer

POWER SUPPLY - 69517

Power supply has 3 output for entry phones. The module has been made with safety and protection in mind and with strong insulation.

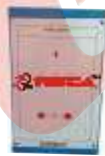

- 01 Apply the 250V AC at input terminal
- 02 See the Light indicator that is glow
- 03 Observe the DC Output at terminal with respect to ground

EMERGENCY PUSH BUTTON - 69518

Emergency stop push button are a must for automated machines and plants in an emergency. Anyone pressing the button immediately puts a machine in a safe state by stopping the hazardous movement. The emergency push button module has a red emergency push button. The switch has one contact. The module has been made with safety and protection in mind and with strong insulation.



01. Connect the emergency switch in the circuit
02. Normal condition the contact are connect
03. When we press the switch than contact are break
04. After that the emergency switch move in clockwise direction for further use

ALARMS - 69519

An alarm device or system of alarm devices gives an audible, visual or other form of alarm signal about a problem or condition. Alarm module comes with a buzzer and a red LED optical indicator. The module has

been made with safety and protection in mind and with strong insulation.



01. Apply the input 230V AC at input terminal
02. Check the RED LED optical indicator blink and hear the sound

SIGNALLING LAMPS 69520

A signal lamp is a visual signalling device for communication. Traffic lights, are signalling devices positioned at road intersections, pedestrian crossing and other locations to control competing flows of traffic. The module signalling lamp has 9 pilot lamps. The module has been made with safety and protection in mind and with strong insulation.



01. Apply the 24V AC at any terminal of signalling lamp
02. See the effect of the indicator is on which the input apply

TWILIGHT SWITCH - 69521

Twilight switches switch the outdoor lighting on and off. As soon as the light intensity falls under a preset lux level, the switch turns on the lighting. On the other hand, if the light intensity is higher than the preset level, then the lighting switches off. The module Twilight switch has adjustable output. The module has been made with safety and protection in mind and with strong insulation.



TIMER SWITCH - 69522

Timer switch is a timer that operates an electric switch controlled by the timing mechanism. It is a daily timer switch with tappets. The module has been made with safety and protection in mind and with strong insulation.



01. Time Setting

Rotate the switching dial in clockwise direction untill the current (day / time incase of weekly model) is almost opposite to the marking arrow F. For fine adjustment rotate the minute hand in the clockwise direction untill the clock shows the current time.

02. Programming

Required switch ON time is set on the switching dial by radially pulling outwards the corresponding black segments. Each segment on daily corresponding to 15mins. & on weekly dial corresponding to 2 Hours.

THREE PHASE POWER SUPPLY - 69523

Three Phase power supply is suitable for a three-phase supply at the mains voltage and frequency. The module has been made with safety and protection in mind and with strong insulation.



01. Connect the three phase R,Y,B,N input at input terminal
02. Switch ON the MCB
03. Turn the key lock switch
04. Push the start switch
05. Check the three phase input indicator light is glow
06. Take the output R,Y,B,N at output terminal

SINGLE PHASE TRANSFORMER - 69524

Single phase transformer is meant to step down to low voltage at the secondary side. The module has been

made with safety and protection in mind and with strong insulation.

01. Apply the input 230V at input terminal
02. Take the output at secondary 12V, 2.2Amp / 50VA



EMERGENCY PUSH BUTTON - 69525

Emergency stop push button are a must for automated machines and plants in an emergency. Anyone pressing the button immediately puts a machine in a safe state by stopping the hazardous movement. The emergency push button module has a red emergency mushroom type push button. It is provided with 1 NO and 1 NC contacts. The module has been made with safety and protection in mind and with strong insulation.



01. At normal position the contact is normally connect
02. When we press the emergency switch than NO is connect and NC is open

THREE PUSH BUTTON - 69526

Push button switches are manually operated switches that are available in many colors, red, yellow, green. The module consists of three push button, red, yellow and green, complete with 1 NO and 1 NC contacts, suitable for the manual control of electric circuits in direct and alternate current.



01. Red push button is meant for stop
02. Yellow push button work as interval to cancel undesired conditions
03. Green push button is used for start or insertion.

The module has been made with safety and protection in mind and with strong insulation

THREE PILOT LAMPS - 69527

Pilot signalling LED lamps and specialty push buttons are designed for heavy-duty applications and hazardous locations. The module has been made with safety and protection in mind and with strong insulation. Three signalling pilot lamps are provided.



- 01 Red lamp indicates danger or alarm of a potential ranger or of a situation that requires an immediate action.
- 02 Yellow lamp indicates warning and a change or imminent change of operating conditions.
- 03 Green lamp indicates safety condition or of an authorization to proceed.

CONTACTOR - 69528

A contactor is an electrically controlled switch used for switching a power circuit, similar to a relay except with higher current ratings. A contactor is controlled by a circuit which has a much lower level than the switched circuit. The module contactor has been made with safety and protection in mind and with strong insulation. Contactor operates as a three-pole power switch through the use of an electromagnet



01. Apply 24V AC at input terminal
02. Internally connected contactor is on
03. Three NO power circuit and one NO auxiliary contact is connect

TIME RELAY - 69529

Time relays are simply control relays with a time delay built in. The module has been made with safety and protection in mind and with strong insulation. Time Relay refers to a multi-voltage and multifunction electronic timer, delayed at the excitation and at the deexcitation.



THERMAL RELAY - 69530

Thermal overload relays are protective devices. They are designed to cut power if the motor draws too much current for an extended period of time. The module has been made with safety and protection in mind and with strong insulation. Thermal relay consists of a three-phase protection against overload and phase loss through a high sensitivity different device with protection against faulty starting.



THREE PHASE INDUCTION MOTOR - 69531



An electric motor converts electrical energy into a mechanical energy which is then supplied to different types of loads. 3 phase Induction Motor consists of an induction motor with slip ring rotor, complete with built-in manual braking device and 3-step starting rheostat. It is supplied with a switch to select different loads. It is supplied with a hooked module with safety terminals for the electric connection. It shows a schematic diagram of the electrical circuits of the motor.

01. Nominal Power 250V / 370W
02. Operating Voltage 380V, 50Hz

THREE POLE SWITCH - 69532

Switch modules come in a wide variety and are designed to familiarize students with various methods of switching voltages, currents and loads. They have been made with safety and protection in mind and are with strong insulation.



PCB Art Work Film Maker

Order Code - 71521



It is a tabletop unit which serves as a negative making contact printer as well as an illuminated Artwork table for Circuit Artwork taping and Inspection of Films and Negatives.

The user can directly make Negatives for IX scale artworks. It has a working area of 300 mm x 250 mm (12"x10") with diffused light and a push button operated exposure.

The overall dimensions are : 380 mm x 230 mm x 330 mm

Electrical Power : 230V/ 50Hz, 5A Socket required

Artwork Table (Illuminated)

Order Code - 71522



Tabletop artwork and PCB inspection table with bottom illumination and diffused light.

Max working area : 350 mm x 450 mm (14"x18")

PCB Shearing Machine

Order Code - 71523



Benchtop Guillotine type shearing machine to cut PCB's and Laminates. Compact structure with central handle allows ease of cutting.

Width : 300 mm (12")

Size : 400 mm x 350 mm

Photo Resist Dip Coating Machine

Order Code - 71524

The machine is table top and compact. A single operation unit designed for coating of laminates with Photo resist. The machine ensures uniform controlled thickness of Photo resist on copper clad.



Max Board Size : 250 mm x 300 mm (10"x 12")

Rectangular Tank Capacity : 2 liters

Dips one PCB at a Time

Electrical Power : 230V/ 50Hz, 5A Socket required

Double Sided UV Exposure Machine

Order Code - 71525



A tabletop double sided exposing unit for high resolution exposure of PCBs. The new small footprint takes minimum space & power.

Maximum Size : 300 mm x 250 mm (12"x10")

U.V. Tubes : 2 x 4 (imported) actinic tubes with single/ double side Option

Chokes : Electronic Type

Timer : Provided

Electrical Power : 230 V -50Hz, 5A Socket required

Dye/ Developer Machine

Order Code - 71526



A unique tabletop unit which gives you the convenience to dyeing and developing PCB laminates both in 1 machine. A diaphragm pump agitates the developing solution chamber. A separate dye chamber is also provided.

Technical Specification:

Max. PCB Size : 250 mm x 300 mm (10"x10")

Tank Capacity : 2 Ltr. For Developer solution, 2 Ltr. For Dye solution

Air pump : Diaphragm type compressor pump

Mechanical Time : Provided to operate air pump

Roller Tinning Machine

Order Code - 71527



It is a table top unit for Tin/ Solder coating of PCB's This coating also improves the solder ability of the PCB. The machine is ideal for polytechnics & engineering colleges.

A hand operated flywheel allows easy coating of boards.

Maximum PCB Width : 250 mm (10")

Maximum PCB Thickness : 6 mm

Solder Bath Capacity : 5 kgs

Heaters : 2 x 500 Watts

Rollers : Silicon Coated

Bearings : Teflon

Electrical Power : 230V - 50 Hz, 5A Socket required

PCB Etching Machine

Order Code - 71528



For fast single and double sided PCB etching. Full PVC structure.

Useful etching area : 250 mm x 300 mm (10" x 12")
 Tank Capacity : 20 Liters. Includes a heater and air flow compressor. All construction materials are corrosion free.
 Heater : Titanium non-corrosive with thermostat control
 Timer : Provided
 Electrical Power : 230/50Hz, 5A Socket required

PCB Drilling Machine

Order Code - 71529



A compact tabletop High speed PCB drilling machine with a Quick change Chuck

- * Drill holding by precision chuck with lapped jaws
- * Mains operated DC motor Direct drive (no belt and pulley)
- * 3 Step Speed Control and Illumination of work Area

Technical Specifications:

Motor Speed : upto 20,000 R.P.M.
 Range : 0.6 to 3.0 mm
 Base : Metal
 Working Area : 280 mm x 170 mm
 Electrical Power : 230/ 50Hz, 5 A Socket required

Chemicals For The PCB Lab Machines

Order Code - 71530

71530I - Chemicals & Accessories Set for PCB Lab (India Market All Chemicals)

71530E - Chemicals & Accessories Set for PCB Lab (Export Market Without Lith Film Developer/Fixer, Photo Resist Liquid/Thinner/Developer, FeCl₃ Etching Crystals and Roller Tin Machine Chemicals)

Board Preparation & Cleaning

- * Single Sided PCB Laminate : 5 Nos.
 Paper Phenolic 300 x 300mm (1 x1 feet)

For Dark Room:

- * Safe Lamp : 1Unit
- * Lith Film 250 x 300 mm (10 x 12") : 10Nos.
- * Lith Film Developer A & B (5 Liters) : 1Pkt

(Not for Exports)

- * Lith Film Fixer (Not for Exports) : 1Bottle
- * Developing Trays : 3 Nos.

For Photoresist Dip Coating Machine

- * Photoresist Liquid (Not for Exports) : 2 Liters
- * Photoresist Thinner (Not for Exports) : 1 Liters
- * Photoresist Developer (Not for Exports) : 5 Liters
- * Photoresist Dye : 5 Liters

For Etching Machine

- * Etching Crystals (Not for Exports) : 5 Kgs.

For PCB Drilling Machine

- Drill Bits
- * 0.80mm : 2 Nos.
 - * 1.00mm : 2 Nos.

For Roller Tin Machine

- * Solder 63.37 : 5 Kgs.
- * Roll Salt : 2 Kgs.
- * Flow Coat : 0.5 Liter.

Note: For export certain chemical are not allowed which are to be arranged from local market.

PCB Drafting Aids Kit

Order Code - 71531

The PCB Drafting Kit includes various tapes, pad and other materials for making PCB Artworks.

PCB Curing Machine (Oven)

Order Code - 71532



Tabletop unit for curing of liquid photoresist, pre-heating substrates etc. A timer controlled heating system allows fast and efficient curing. Complete metal construction.

Max : 250 mm x 300 mm (10" x 12")
 Heating : Heaters with thermostat controls
 Fan : For air circulation
 Timer : Provided
 Shelf : Included
 Electrical Power : 230/ 50 Hz. 5A Socket required

Single Sided Ultra Violet Exposure Machine

Order Code - 71533



For exposure of single sided photosensitive PCBs

U.V. Tubes : 4 Nos X 8 Watts Actinic tubes
 Tube length : 300 mm (12")
 Area : 300 mm X 255 mm (12" X 10")
 Contact : Pressure Type
 Timer : 0-4.0 minutes
 Electrical Power : 230V-50Hz, 5A Socket required

Solderable laquer Tank

Order Code - 71534

This is a table top unit which is used for protecting the PCB from environment. This chemical coated on PCB ensures protection for long time.

Supply : 230V AC \pm 10%
 50Hz
 Timer : Adjustable from 1
 Sec to 30 Sec at interval of 5 Sec.
 Display : 16 X 2 LCD for timer
 Buzzer : For indication
 Dipping area : 12" X 10"



6-Axis Robotics Trainer

Order Code - 49501



6-Axis Robotics Trainer is versatile training equipment, not only for Mechatronics students but also for all robotics enthusiasts to understand the very basic concept of robotics i.e. study of axis motions. To make it simple we have provided a programmable robotic arm with an interactive front panel. Accompanied software demonstrates complete functioning of trainer as well as allows user to develop their own programs.

- * Study of Stepper motor and Servo motor
- * Study of Sensors
- * Each axis can be controlled individually
- * Ideal to understand basics of CNC machine
- * Can be operated from 8 bit microcontroller to ARM processors
- * Can be controlled from computer
- * Programmable tasks
- * Record and Play capability
- * Optional interfacing with PLC
- * Ample work area
- * Touch operated ON/OFF switch
- * Auto set to home position
- * User can develop own applications
- * Self-contained and easy to operate
- * Data acquisition using USB
- * Graphical representation
- * User friendly software
- * Exhaustive course material & references

Technical Specification:

Work Area	:	400 × 400 mm
Gripper AOF	:	180°
Gripper Payload	:	250 g
Number of Stepper Motors	:	3
Number of Servo Motors	:	4
Number of IR Switches	:	2

Stepper Motor Specifications

Type	:	6 wire, Unipolar
Step Angle	:	1.8°
Holding Torque	:	4.1 Kg cm
Operating Voltage	:	5 Volts

Servo Motor Specifications

Control System	:	PWM 1520 ìsec Neutral
Stall Torque	:	3.2 Kg cm
Operating Voltage	:	5 Volts
Sensor	:	IR as Limit Switch

Drive type

X & Y Axis	:	Belt Driven – 2 Axis
Z Axis	:	Servo Motor Driven – 4 Axis

Dimensions (mm)	:	610 × 500 × 490
Weight	:	7 Kg (approximately)
Power Supply	:	230 V ±10%, 50 Hz (others on request)

Robotic Arm

Order Code - 49502



An industrial robot with five joints closely resembles a human arm - it has the equivalent of a shoulder, an elbow and a wrist. Robotic arm has a vital role in industrial development. Study of Robotic Arm is a combination of physics, mathematics, mechanical, electronics, structural engineering and computer science.

Robotic Arm is versatile training equipment for all robotics enthusiasts to understand the very basic concept of robotics. Robotic arm can be controlled from software or control panel. Control panel has LCD, switches, home sensor LED, connector for external interface with DIP switches and USB interface. From software user can control each DOF individually through mouse click or key board. Programming a robot was never so easy before our software where user can write instructions in editor window which after compiling can directly downloaded into the processor of robotic arm for defined Automation Task.

- * Study of Stepper motor, Servo motor, DC Motor and feedback control system
- * Easy steps for programming robotic Arm
- * Each servo can be controlled individually by giving start angle, stop angle and speed
- * Each axis can be controlled individually
- * Can be operated from 8 bit microcontroller to ARM processors
- * Can be controlled from computer
- * Easy instruction programming editor for Programmable tasks
- * Optional interfacing with PLC
- * Ample work area
- * Touch operated ON/OFF switch
- * Auto set to home position
- * User can develop own applications
- * Self-contained and easy to operate
- * Data acquisition using USB
- * User friendly software
- * Exhaustive course material, references and Demo Programs

Technical Specifications:

Work volume	:	2100000 mm ³
Base AOF	:	300°
Elbow AOF	:	90°
Wrist AOF	:	180°
Wrist Turn AOF	:	180°
Gripper AOF	:	80°
Allowed Payload	:	350 g
Number of Stepper Motor	:	1
Number of DC Motor	:	2
Number of Servo Motors	:	3
Number of limit Switch	:	1

Stepper Motor Specifications :

Type	:	6 wire, Unipolar
Step Angle	:	1.8°
Holding Torque	:	20 Kg.cm
Operating Voltage	:	5 Volts

Servo Motor Specifications:

Control System	:	PWM 1520 ìsec Neutral
Stall Torque	:	16 Kg-cm
Operating Voltage	:	5 Volts

DC Motor Specifications:

Control System	:	PWM 1520 ìsec Neutral
Stall Torque	:	7.5 Kg-cm
Operating Voltage	:	12 Volts
Sensor	:	Limit Switch
Dimensions (mm)	:	W 190 ´ D 190 ´ H 650

Weight : 3 Kg (approximately)
 Power Supply : 230 V \pm 10%, 50 Hz
 (others on request)

Robotic Kits

Order Code - 49503-49509

Technical Education Training Equipments

Robotic DIY (Do It Yourself) Kits enhances learning skills for Hobbyist, Science & Engg. Students. The kits enhances technical skills in the field of soldering, electronics, sensors (light, sound, infrared) and mechanical systems. They provide hands on experience for co-ordination of electronics with mechanical arrangements to give shape to a science, ROBOTICS. All the kits are complete with different parts, electronic & mechanical components, step by step write up, circuits and mechanical arrangements. The system can be assembled by learner to give them PRACTICAL EDGE.



Order Code - 49503
 Line Tracking Mouse
 (Light Sensor)



Order Code - 49504
 Sound Reversing Car
 (Sound Sensor)



Order Code - 49505
 Turning Frog
 (Sound Sensor)

**Order Code - 49507
 Scab Robot Kit (Sound Sensor):**



Scrab is a robot that makes use of two touch sensorsto detect obstacles. When its Antennal (Touch Sensor) detects an object in its path, Scrab will go backward first and automatically follow a two step maneuver to overcome the obstacle. The step can be a combination of Right, Left, Reverse or Stop. The robo can be configured for different set of movements.

**Order Code - 49508
 Ladybug Robot Kit (Infrared Sensor):**



Ladybug Robot works on its six legs and makes use of infrared light emitting diodes as its eyes to avoid obstacles. The Robo makes a left turn when there is shadow in front of it and continues to move unless there is again shadow. The electronic settings can be changed to give different sets of movement andprovides fun to the learners.

**Order Code - 49509
 Escape Robot Kit (Infrared Sensor):**



Escape Robot Kit works on A. I. And never fails to find its way out of maze. It uses 3 Infrared emitting diodes and 1 Infrared receiving module to send and receive signals and detect obstacles. The Robo thinks on its own, due to the inbuilt microprocessor, which gives him edge. The kit comes with 2 types of six legs, which gives endless fun and excitement.

Infrared Remote Control Kits

Order Code - 49510



Titan Tank

Titan Tank is an infrared remote control kit, its microprocessor provides 4 different channels to have 4 titans to fight with each other at same time. Each titan was set with 8 shots and it is designed to make a sound when shooting. Once the titan was struck, it will turn 360 and make a sound like ambulance, you have to restart it to play again. Titan moves by 6 wheels which can move forward, backward, right & left for total 8 movements which provides endless fun and excitement.

Robot Arm Kit

Order Code - 49513



Wired Control Robot ARM

Learning basic robotic technology and build your own wired control Robot Arm with five motors and five joints. With its five-switch wired controller, the Robot features base Rotation, Shoulder, elbow and wrist motion, and functional gripper. The 5 motors operate the grab, lift lower, and release smoothly maximum lifting capacity : 100G

Robot Arm Kit With USB PC Interface

Order Code - 49515



Learning basic robotic technology and build your own wired control Robot Arm with five motors and five joints. With its five-switch wired controller, the Robot features base Rotation, Shoulder, elbow and wrist

motion, and functional gripper. The 5 motors operate the grab, lift lower, and release smoothly maximum lifting capacity : 100Gm.

This Robotic Arm connects to the Windows personal computer USB port, suitable for Windows XP /Vista/ Windows 7 (works with 32 & 64 bit version) operation system. Software includes below functions. It creates a fun way of learning and experimenting your Robotic Arm with computer.

- * Basic : By using keyboard or mouse to have real time manual control of the arm
- * Regarding : Record, save and replay the movements
- * Programming : Creating & editing a program, save and load
- * Just like normal computer files

It comes with USB interface kit which connects our 49513 Robotic Arm to a Windows personal computer USB port suitable for windows XP/ Vista / Windows 7 operation system. (works with 32 & 64 bit version)

Kit Includes:

01. CD
02. All mechanical parts to make working robot
03. Printed Circuit Boards
04. USB cable & other necessary parts
05. Detailed instruction manual

Universal Robotics Development Platform

Order Code - 49517



URDP (Universal Robotics Development Platform)

It's a versatile development platform designed for beginners to implement their ideas at speed. With perforated side walls, incorporation of various sensors, actuators, mechanical assemblies is a simple task.

It comes with 8051 based microcontroller development board equipped with many features. It also includes IR proximity sensors and Line sensors to implement projects like Obstacle avoider ,Line following robot and more..

This kit comes unassembled, after assembling it can be easily reprogrammed through a simple desktop computer.

Features of chassis:

01. Die cut high quality aluminum
02. High Quality anti rust powder coating
03. Innovative prototyping area
04. Easy implementation of wide variety of robots

Features of Robot Controller:

01. 8051 Core NXP P89V51RD2
02. On-board motor drivers, for driving 4 DC motors or 2 stepper motors
03. On board level converter for serial communication
04. On board power regulator
05. 16X2 LCD screen
06. Terminal block for easy connection of motors
07. Protection against noise and back EMF
08. Protection against wrong polarity wiring of battery/power supply

09. On-board LEDs for debugging and testing
10. Berg expansion slots

Features of IR Sensors:

01. Range: 20 cm
02. Ambient light protection
03. Easy interface with microcontroller
04. On board LED to indicate logic signals

Features of Line Sensors:

01. Array of 5 sensors
02. 5 TTL compatible outputs for interfacing with microcontroller
03. Immunity against ambient light
04. 5 LEDs to indicate logic levels
05. 5 individual presets to control ref voltage of each pair

Package Includes:

01. Microcontroller: NXP 89V51RD2
02. Pack of essential electronic components and ICs
03. Robot Controller PCB:1
04. IR Sensor PCB:2
05. Line Sensor assembled and tested PCB: 1
06. Powder coated Aluminum chassis:1
07. 100rpm,12VDC Geared Motors :1
08. Plastic wheels:2
09. Front castor wheel :1
10. DPDT switches with holder plate:2
11. Power supply components: 1 set
12. Pack of Nuts and bolts:1
13. Manual in CD

Application Examples

01. Manually controlled robot
02. Automated guided vehicle
03. Obstacle avoiding robot
04. Edge avoiding Robot
05. Micro mouse
06. Wall hugging Robot
07. Line following robot
08. Grid following robot
09. Wired Computer Controlled Robot

Other Modules Worth Buying(NOT included in kit):

01. Cellphone Control Module: To control your machine through cell phone.
02. Wireless control: To control your machine wirelessly through computer and through voice commands also

Golbo

Order Code - 49518



URDP (Universal Robotics Development Platform)

01. 8051 Core NXP P89V51RD2 microcontroller
02. On-board motor drivers, for driving 4 DC motors or 2 stepper motors
03. On board level converter for serial communication
04. On board power regulator
05. 16X2 LCD screen
06. Terminal block for easy connection of motors

07. Protection against noise and back EMF
08. On-board LEDs for debugging and testing
09. Berg expansion slots

Features of IR Sensors:

01. Range: 20 cm
 02. Ambient light protection
 03. Easy interface with microcontroller
 04. On board LED to indicate logic signals
- It comes completely unassembled with instruction manual in CD.

Other Modules Worth Buying(NOT included in kit):

01. Microcontroller : NXP 89V51RD2:1
02. Pack of Necessary IC and Electronics components:1
03. Main PCB:1
04. Sensor PCB:2
05. Aluminum Chassis:1 set
06. Castor wheel:1
07. Plastic Wheels:2
08. 5rpm,12VDC,Geared Motor:2
09. Serial Programming Cable
10. Pack of Nuts and Bolts:1
11. Instruction Manual in CD:1
12. Power Supply components
13. DPDT switches with holder plate:2
14. Manual in CD

Application Examples

01. Manually controlled robot
02. Automated guided vehicle
03. Obstacle avoiding robot
04. Edge avoiding Robot
05. Wall hugging Robot
06. Wired Computer Controlled Robot

Suggested other modules worth buying: (NOT included in Kit)

01. Cellphone control Module: To make it move by keypress command from cellphone.
02. Line Sensor Array: To make it behave as line follower or grid follower
03. Wireless Computer Control Kit: To control this machine wirelessly through computer just like your video game. This modules also allows you to control machine through voice commands.

Hexapod-DC Motor Based

Order Code - 49519



Hexapod

6 legged member of our family, helps to cultivate programming and analytical skills. Motion of Geared servo is controlled by AVR based microcontroller development board, equipped with motor driving circuitry. This kit comes unassembled and can be easily programmed by simple desktop computer and knowledge of embedded C.

Features of Robot Controller:

01. Arduino based on ATmega8
02. On-board motor drivers, for driving 4 DC motors or 2 stepper motors
03. On board level converter for serial communication
04. On board power regulator
05. 16X2 LCD screen
06. Terminal block for easy connection of motors
07. Protection against noise and back EMF
08. Protection against wrong polarity wiring of battery/power supply
09. On-board LEDs for debugging and testing
10. Berg expansion slots

Package Includes:

01. Arduino Kit: ATmega8
02. Pack of essential electronic components and ICs
03. Robot Controller PCB:1
04. Motor Driver PCB:2
05. Powder coated Aluminum parts:1 set
06. 5 rpm,12VDC Geared Motors :12
07. Plastic wheels:2
08. Serial Programming Cable:1
09. Connecting Cables:2
10. Power supply components: 1 set
11. Pack of Nuts and bolts:1
12. Manual in CD

URDP Arm Kit

Order Code - 49520



This kit consist of aluminum parts, assemblies , motors, wheels and tracks. Combining all these parts user can create a pick and place robot with gripper. Unique design of gripper allows it to hold object as huge as 10cms and as small as 1 cm in width. This kit gives the machine an additional 2 degrees of freedom. High torque motor at arm joint gives it ability to lift load of 200grams.

The controlling part of kit is based around 8051 microcontroller, equipped with motor drivers and ISP facility to program it on board.

Features of mechanical assembly:

01. Lead screw arrangement for gripper
02. Unique set of shaft couplers
03. Rubber tracks for extra traction
04. 4 wheel assemble extension for better stability

Features of Robot Controller:

01. 8051 Core NXP P89V51RD2
02. On-board motor drivers, for driving 4 DC motors or 2 stepper motors
03. On board level converter for serial communication
04. On board power regulator
05. 16X2 LCD screen
06. Terminal block for easy connection of motors
07. Protection against noise and back EMF
08. Protection against wrong polarity wiring of battery/power supply
09. On-board LEDs for debugging and testing

Application Examples:

- 01. Manually Controlled Robot
- 02. Automated Guided Vehicle
- 03. Wired Computer controlled Robot

Package Includes:

- 01. Microcontroller: NXP 89V51RD2
 - 02. Pack of essential electronic components and ICs
 - 03. Robot Controller PCB: 1
 - 04. Powder coated Aluminum partd1
 - 05. 100 rpm, 12VDC Geared Motors : 3
 - 06. 5 rpm, 12VDC Geared Motors : 3
 - 07. Plastic wheels: 4
 - 08. Rubber track belts: 2
 - 09. DPDT Switches : 4
 - 10. Power supply components: 1 set
 - 11. Pack of Nuts and Bolts: 1
 - 12. Manual in CD
- Suggested other modules worth buying: (NOT included in Kit)

Other Modules Worth Buying(NOT included in kit):

- 01. Cellphone control Module: To make it move by keypress command from cellphone.
- 02. Line Sensor Array: To make it behave as line follower or grid follower
- 03. Wireless Computer Control Kit: To control this machine wirelessly through computer just like your video game. This modules also allows you to control machine through voice Commands.

Edge Avoiding Robot

Order Code - 49521



This is a 8051 Microcontroller based kit, equipped with IR sensors and motor driver. It basically sense the presence or absence of ground below it through IR Sensors and take a proper motion accordingly. It comes completely unassembled with instruction manual in CD.

Package Include:

- 01. Microcontroller : NXP 89V51RD2:1
- 02. Pack of Necessary IC and Electronics components:1
- 03. Main PCB:1
- 04. Sensor PCB:1
- 05. Aluminum Chassis
- 06. Castor wheel:1
- 07. Plastic Wheels:2
- 08. 100rpm,12VDC,Geared Motor:2
- 09. Pack of Nuts and Bolts:1
- 10. Instruction Manual in CD:1
- 11. Power Supply Components

WatchVideo:http://www.youtube.com/watch?v=5oB8ow_OncM

Wall Following Robot

Order Code - 49522



This machine is based on 8051 microcontroller, equipped with three IR proximity sensors. Basic operation of this machine is to sense the presence of wall and follow it while taking proper turns around the corners.

It comes completely unassembled with instruction manual in CD.

- 01. Microcontroller : NXP89V51RD2:1
- 02. Pack of Necessary IC and Electronics components : 1
- 03. Main PCB : 1
- 04. Sensor PCB : 3
- 05. Aluminum Parts : 3
- 06. Red translucent, top plate : 1
- 07. Castor wheel : 1
- 08. Plastic Wheels : 2
- 09. 100rpm,12VDC,Geared Motor : 2
- 10. Pack of Nuts and Bolts : 1
- 11. Instruction Manual in CD : 1
- 12. Power Supply Components : 1

Vacuum Cleaning Robot

Order Code - 49523



This machine demonstrates functioning of a robotic vacuum cleaner. It is preprogrammed to move in a particular fashion while collecting small dirt particles. It is build around 8051 microcontroller with motor drivers to control motion of machine and operation of a small vacuum creating fan.

It comes completely unassembled with instruction manual in CD.

Package Include:

- 01. Microcontroller : NXP 89V51RD2:1
- 02. Pack of Necessary IC and Electronics components:1
- 03. Main PCB:1
- 04. Red translucent acrylic base plate:1
- 05. Aluminum Top Cover:1
- 06. Castor wheel:1
- 07. Plastic Wheels:2
- 08. 5rpm,12VDC,Geared Motor:2
- 09. Pack of Nuts and Bolts:1
- 10. Instruction Manual in CD:1
- 11. Power Supply components (Included 30 Sept, 2010 Onwards)

Obstacle Avoiding Robot

Order Code - 49524



This ROBOT has sufficient intelligence to cover the maximum area of provided space. It has a infrared sensor which are used to sense the obstacles coming in between the path of ROBOT. It will move in a particular direction and avoid the obstacle which is coming in its path. It is built around 8051 microcontroller, equipped with motor drivers and IR sensors on 3 sides to detect absence or presence of obstacles and take movement according

It comes completely unassembled with instruction manual in CD.

Package Include:

01. Microcontroller : NXP 89V51RD2:1
02. Pack of Necessary IC and Electronics components:1
03. Main PCB:1
04. Sensor PCB:3
05. Red translucent acrylic base plate:1
06. Aluminum Top Cover:1
07. Castor wheel:1
08. Plastic Wheels:2
09. 5rpm,12VDC,Geared Motor:2
10. Pack of Nuts and Bolts:1
11. Instruction Manual in CD:1
12. Power Supply components

Robotic Fork Lift

Order Code - 49525



An Industrial forklift (also called a lift truck, a high/low, a stacker-truck, trailer loader, sideloader, fork truck, tow-motor or a fork hoist) is a powered industrial truck used to lift and transport materials. The modern forklift was developed in the 1920s by various companies including the transmission manufacturing company Clark and the hoist company Yale & Towne Manufacturing.[1] The forklift has since become an indispensable piece of equipment in manufacturing and warehousing operations. This machine is a demonstrator of operation a real fork lift. It is manually operated through set of DPDT switches It comes completely unassembled with instruction manual in CD.

Package Include:

01. Red translucent acrylic base plate:1
 02. Aluminum Parts:1 set
 03. Castor wheel:1
 04. Plastic Wheels:4
 05. 100 rpm,12VDC,Geared Motor:3
 06. Rubber Track belts:2
 07. Pack of Nuts and Bolts:1
 08. Instruction Manual in CD:1
 09. Power Supply components
01. Robot Controller: This module will provide intelligence to the machine through 8051 microcontroller.
 02. Cellphone control Module: To make it move by keypress command from cellphone.
 03. Line Sensor Array: To make it behave as line

follower or grid follower

04. Wireless Computer Control Kit: To control this machine wirelessly through computer just like your video game. This modules also allows you to control machine through voice Commands.

Agriculture Robot

Order Code - 49526



An agricultural robot or agribot is a robot deployed for agricultural purposes. The main area of application of robots in agriculture is at the harvesting stage. Fruit picking robots and sheep shearing robots are designed to replace human labor. The agricultural industry is behind other complementary industries in using robots because the sort of jobs involved in agriculture are not straightforward, and many repetitive tasks are not exactly the same every time. In most cases, a lot of factors have to be considered (e.g., the size and color of the fruit to be picked) before the commencement of a task. Robots can be used for other horticultural tasks such as pruning, weeding, spraying and monitoring. Our Agriculture robot is designed around 8051 microcontroller that help machine to maneuver and operate autonomously to demonstrate the process of sowing seeds in farm.

Package Include:

01. Microcontroller NXP 89V51RD2
02. Pack of Necessary IC and Electronics components:1 set
03. Aluminum Parts:1 set
04. Plastic Wheels:4
05. 5 rpm,12VDC,Geared Motor:4
06. Rubber Track belts:2
07. Pack of Nuts and Bolts:1
08. Instruction Manual in CD:1
09. Power Supply components

Object Sorting Robot

Order Code - 49527



In many industries it is required to sort objects from a mixture of materials. This machine is an demonstrator of industrial object sorting robot based on color of object. It is based on 8051 microcontroller equipped with IR Black/White and LDR as object sensors to sense position and color of object. After sensing object and its color robotic arm place them left or right of conveyer belt accordingly. It comes completely unassembled with instruction manual in CD.

Package Include:

01. Microcontroller NXP 89V51RD2
02. Pack of Necessary IC and Electronics components:1 set
03. Aluminum Parts:1 set

- 04. Plastic Wheels:3
- 05. 5 rpm,12VDC,Geared Motor:2
- 06. 100 rpm,12VDC,Geared Motor:1
- 07. Robot Controller PCB:1
- 08. Comparator PCB:1
- 09. Conveyer Belt:1
- 10. Pack of Nuts and Bolts:1
- 11. Instruction Manual in CD:1
- 12. Power Supply components

Fire Fighting Robot

Order Code - 49528



Firefighting is an important but dangerous occupation. A firefighter must be able to get to a fire quickly and safely extinguish the fire, preventing further damage and reduce fatalities. Technology has finally bridged the gap between firefighting and machines allowing for a more efficient and effective method of firefighting. Robots designed to find a fire, before it rages out of control, could one day work with firefighters greatly reducing the risk of injury to victims.

Features:

- 01. Based on 8051 development board for modularity
- 02. On- board serial programmer
- 03. On board 16x2 LCD display
- 04. Motor driving ports capable of driving 4 motors
- 05. Wireless control supported (optional, Not included)
- 06. Manual and computer control (optional, Not included)

Package Include:

- 01. Microcontroller NXP 89V51RD2
- 02. Pack of Necessary IC and Electronics components:1 set
- 03. Aluminum Parts:1 set
- 04. Plastic Wheels:4
- 05. 5 rpm,12VDC,Geared Motor:2
- 06. 100 rpm,12VDC,Geared Motor:1
- 07. Robot Controller PCB:1
- 08. Comparator PCB:1
- 09. RubberBelts:2
- 10. Pack of Nuts and Bolts:1
- 11. Instruction Manual in CD:1
- 12. Power Supply components
- 13. Water pump:1
- 14. Water tank:1
- 15. Water jet:1

Pipe Climbing Robot

Order Code - 49529



Industrial pipe systems are inaccessible and narrow. The pipes can be vertical and have junctions. Just as challenging, leakage points in the water system must be located, the condition of oil and gas pipelines must be checked and ventilation systems need to be cleaned.

Features:

- 01. Based on 8051 development board for modularity
- 02. On- board serial programmer
- 03. On board 16x2 LCD display
- 04. Motor driving ports capable of driving 4 motors
- 05. Wireless control supported (optional, Not included)
- 06. Manual and computer control (optional, Not included)

Package Include:

- 01. Microcontroller NXP 89V51RD2
- 02. Pack of Necessary IC and Electronics components:1 set
- 03. Aluminum Parts:1 set
- 04. Plastic Wheels:4
- 05. 5 rpm,12VDC,Geared Motor:4
- 06. Robot Controller PCB:1
- 07. Pack of Nuts and Bolts:1
- 08. Instruction Manual in CD:1
- 09. Power Supply components

MATLAB Based Surveillance Robot

Order Code - 49530



This machine is a unique blend of software and hardware. It's a mobile platform that user can control through his computer with a proper feedback through wired webcam. The GUI is made through MATLAB software which gives an opportunity to user to understand basic MATLAB and its toolboxes. It also helps to understand serial interfacing of devices through MATLAB. This project can be extended by user for developing applications such as Football playing robot etc..

Features:

- 01. Based on 8051 development board for modularity
- 02. On- board serial programmer
- 03. On board 16x2 LCD display
- 04. Motor driving ports capable of driving 4 motors
- 05. Wireless control supported (optional, Not included)
- 06. MATLAB basics and code explained in detail
- 07. On-Machine camera

Package Include:

- 01. Microcontroller NXP 89V51RD2
- 02. Pack of Necessary IC and Electronics components:1 set
- 03. Aluminum Parts:1 set
- 04. Plastic Wheels:2
- 05. 100 or 60 rpm,12VDC,Geared Motor:2
- 06. Robot Controller PCB:1
- 07. Pack of Nuts and Bolts:1
- 08. Instruction Manual in CD:1
- 09. Power Supply components
- 10. Webcam
- 11. Serial Cable

Robot Controller

Order Code - 49531



It is 8051 microcontroller based development board equipped with many on-board peripherals that makes it suitable for developing various autonomous robots, electronic projects and other embedded systems applications. With In-system programming facility it becomes a very easy and handy tool for any developer.

Features:

01. 8051 Core NXP P89V51RD2 microcontroller clocked at 11.0592Mhz
02. On-board motor drivers, capable of driving 4 DC motors or 2 stepper motors
03. On board level converter for serial communication
04. On board power regulator
05. 16X2 LCD screen
06. Terminal block for easy connection of motors
07. Protection against noise and back EMF
08. Protection against wrong polarity wiring of battery/power supply
10. On-board LEDs for debugging and testing
11. Berg expansion slots

Package Includes:

01. Robot controller board
02. Serial Cable
03. Software CD with operating manual and sample codes

Freeduino-USB

Order Code - 49532



Freeduino Serial is a low cost arduino derivate, and is 100% hardware and software compatible to the popular Arduino Open Source Hardware platform.

Features:

01. Easy configuration from Software
02. Input/Output lines can be expanded easily using I2C or SIPO
03. Upload and run programs directly from Arduino Software
04. Easy USB connectivity to Personal Computer
05. Easy programming interface in C/C++ using Arduino software (free)

Experiments:

01. Based on ATmega8
02. Advanced RISC Architecture based powerful processor
03. CPU Clock @ 16MHZ
04. On board Hardware reset
05. 14 direct Digital I/O Lines
06. 6 direct Analog I/O Lines
07. ICSP Compatible with many programmers
08. On board 8-16KB Programmable Flash memory & 512 Bytes EEPROM
09. All pins can be programmed for interrupt on change

URDP Chassis

Order Code - 49533



URDP (Universal Robotics Development Platform)

It's a versatile Development platform designed for students and enthusiasts to implement their ideas at speed. With perforated side walls, incorporation of various sensors, actuators, mechanical assemblies is a simple task.

Features:

01. Die cut high quality aluminum
02. High Quality anti rust powder coating
03. Innovative prototyping area
04. Easy implementation of wide variety of robots

Package Includes:

01. Powder coated Aluminum chassis
02. Two Motors
03. Two Wheels
04. Front castor wheel
05. Pack of Nuts and bolts

List of machines that can be developed using URDP and modules:

01. Manually controlled robot
02. Automated guided vehicle
03. Obstacle avoiding robot
04. Edge avoiding Robot
05. Micro mouse
06. Wall hugging Robot
07. Line following robot
08. Grid following robot
09. Pick and place robot
10. Color based object sorting robot
11. Computer control robot
12. Gamepad control robot
13. Speech control robot
14. Remote controlled robot
15. Cell phone control module
16. Temperature sensing
17. Temperature activation
18. Light activated robot
19. Light following robot
20. Ultrasonic obstacle avoider
21. Distance programmable obstacle avoider
22. Object mapping robot

Arm & Gripper Kit

Order Code - 49534



Robotic Arm and Gripper Kit

This kit consist of aluminum parts, assemblies , motors, wheels and tracks. Combining all these parts user can create a pick and place robot with gripper. Unique design of gripper allows it to hold object as huge as 10cms and as small as 1 cm in width. This kit gives the machine an additional 2 degrees of freedom. High torque motor at arm joint gives it ability to lift load of 200grams.

Features:

01. Lead screw arrangement for gripper
02. Unique set of shaft couplers
03. Rubber tracks for extra traction
04. 4 wheel assemble extension for better stability

05. Powerful gripper

Package Includes:

- 01. Powder coated aluminum parts
- 02. Set of shaft couplers
- 03. Set of rubber tracks
- 04. Wheels
- 05. 100rpm motor-1
- 06. 3.5 rpm motor-1

Scoobot Beginners, Advance, Microcontroller Kit

Order Code - 49536-49538



Scoobot is designed specially for school kids to enhance their learning and creativity through fun.

What`s so special about this kit?

- * It's a multifunctional kit: With kit and its modules students can make 10 + machines.
- * Learning's: This kit is based on CBSE/ICSE class 7 to class 12 physics activities, with animated tutorials of book concepts.
- * Modularity: Kit comes in a modular form hence students can exchange modules just as they exchange video game CDs. Therefore more learning more fun and more relaxation to parents pocket.
- * Animated Tutorials: Students gets all the guidance and instructions through an animated series of tutorials with exercises and quizzes at proper interval.

What all can be learned/made from this kit?

Learning's

- 01. Fundamental of physics
- 02. Controlling Motors
- 03. About different electronic components
- 04. Developing Logic for diving the machine
- 05. Wiring of machine
- 06. Basics of mechanics
- 07. Use of tools and many more...

Constructions

- 01. Manually Controlled Robot
- 02. Obstacle Avoiding Robot
- 03. Line following Robot
- 04. Cell Phone Controlled Robot
- 05. TV remote controlled Robot
- 06. Computer Controlled Robot
- 07. Voice Controlled Robot
- 08. Computer Programmed Robot
- 09. Wireless Remote Controlled Robot
- 10. Light Controlled Robot and more...

49536-Scoobot Beginners Kit:

Experiments Included:

- 01. Manually Controlled Robot
- 02. Obstacle Avoiding Robot
- 03. Edge Avoiding Robot
- 04. Line following Robot
- 05. Cell Phone Controlled Robot
- 06. TV remote controlled Robot

49537-Scoobot Advance Kit:

Experiments Included:

- 01. Manually Controlled Robot
- 02. Obstacle Avoiding Robot
- 03. Edge Avoiding Robot
- 04. Line following Robot
- 05. Cell Phone Controlled Robot
- 06. TV remote Controlled Robot
- 07. Computer Controlled Robot
- 08. Voice Controlled Robot
- 09. Computer Programmed Robot
- 10. Wireless Remote Controlled Robot
- 11. Light Controlled Robot
- 12. Sound Activated Robot and more...

49538-Scoobot Microcontroller Kit:

Experiments Included:

- 01. All the experiments included of Advance kit will be implemented using "Arduino Board" via "C Programming Language"

Robotics in 10 Days

Order Code - 49539



Kit Includes:

Modules:

- 01. IR Sensor Module
- 02. 1xCell phone controlled module
- 03. 1xLine follower Module
- 04. 1xAmbient Light Sensor (Unassembled)
- 05. 2x lead acid Rechargeable Battery
- 06. 2x DC Motors
- 07. 1x Digital Multimeter
- 08. 1x Wire stripper or cutter
- 09. 1x Battery Charger Adaptor
- 10. 1x Soldering paste (FLUX)
- 11. 1x Soldering Iron
- 12. 1x forceps
- 13. 1x Breadboard

Electronic Components

- 01. 1x7805 IC
- 02. 1x3mm LED
- 03. 1x470e resistor
- 04. 1xL293D IC (Motor Driver IC)
- 05. 1x74HC04 Inverter IC
- 06. 1x Caster wheel
- 07. 2x Motor wheels
- 08. 2x Motor support strips
- 09. 1xConnecting wires
- 10. 1xTwo pin Reliment connector (Charger Battery Connector)
- 11. 1xChassis-top & bottom Plate
- 12. 1xSoldering Wire, Heat Sinkable Sleeve, 1000uf capacitor
- 13. 2xBattery tie clips
- 14. 1xManual in CD
- 15. 1xScrew driver
- 16. 1xAll screws & nuts

Robotics in 10 Days-GOLBO MINI is a FIVE in ONE

versatile tool for students to learn basics of Robotics and electronics in a fast pace . The instructional guide is self explanatory with many full color pictures and video. That allows user to learn without anyone else`s help.



Obstacle Avoider Mobile Controlled Light Activated Edge Avoider Line Follower

What all can be learned/made from this kit? Learning's

01. Fundamental of physics
02. Controlling Motors
03. About different electronic components
04. Developing Logic for diving the machine
05. Wiring of machine
06. Basics of mechanics
07. Use of tools and many more....

Constructions

01. Obstacle Avoiding Robot
02. Line following Robot
03. Cell Phone Controlled Robot
04. Edge Avoiding Robot
05. Light Controlled Robot and more...

Voice Controlled Robot Arm

Order Code - 49540



Imagine how fascinating it would be, if you can control machines/devices through your voice commands. Here we introduce our voice controlled robot that is fully functional through human voice commands. It accepts all the words in English in male as well as female voices. High torque motor at arm joint gives it ability to lift load of 200grams.

The controlling part of kit is based around 8051 microcontroller, equipped with motor drivers and ISP facility to program it on board.

Features of mechanical assembly:

01. Lead screw arrangement for gripper
02. Unique set of shaft couplers
03. Rubber tracks for extra traction
04. 4 wheel assemble extension for better stability

Features of Robot Controller:

01. 8051 Core NXP P89V51RD2
02. On-board motor drivers, for driving 4 DC motors or 2 stepper motors
03. On board level converter for serial communication
04. On board power regulator
05. 16X2 LCD screen
06. Terminal block for easy connection of motors
07. Protection against noise and back EMF
08. Protection against wrong polarity wiring of battery/power supply
09. On-board LEDs for debugging and testing

Package Includes:

01. Microcontroller: NXP 89V51RD2
02. Pack of essential electronic components and ICs
03. Robot Controller PCB:1
04. Powder coated Aluminum partd1
05. 100 rpm,12VDC Geared Motors :3
06. 5 rpm,12VDC Geared Motors :3
07. Plastic wheels:4
08. Rubber track belts:2
09. Power supply components: 1 set
10. Pack of Nuts and Bolts:1
11. Manual in CD

Working: The system consists of microcontroller that is connected with a computer via serial port. Over computer a special program runs that is being developed by Technido. This software receiver voice signals from microphone and process them in order to recognize the word. According to received word software sends signals to microcontroller in a predefined protocol. Upon reception of signal from computer microcontroller transmits these signals wirelessly to mobile platform.

Pluton Mini-8051 Robotic Kit

Order Code - 49541



Most popular robot for beginners, the Line followers is now available with the legacy of 8051 and choice of Serial or USB programming.

The controlling part of kit is based around 8051 microcontroller, equipped with motor drivers and ISP facility to program it on board.

Features of mechanical assembly:

01. Laser cut chassis
02. Aluminum brackets
03. 150 Rpm BO motors
04. Special slots for Line sensors

Features of Robot Controller and Modules:

01. 8051 Core NXP P89V51RD2 (For serial version)
02. 8051 core AT89S52 (For USB version)
03. On-board motor drivers, for driving 2 DC motors or 1 stepper motors
04. On board level converter for serial communication
05. On board power regulator
06. Terminal block for easy connection of motors
07. Protection against noise and back EMF
08. Protection against wrong polarity wiring of battery/power supply
09. On-board LEDs for debugging and testing
10. On-board preset for sensor adjustments

Prerequisites:

01. Working Knowledge of C.
02. Syntax and semantics
03. loops and conditions
04. Functions

Package Includes:

01. Microcontroller: NXP 89V51RD2 or AT89S51
02. Pack of essential electronic components and ICs

03. Controller PCB:1
04. Aluminum parts; 1 set
05. 150 rpm,12VDC Geared Motors :2
06. Plastic wheels:2
07. Castor Wheels
08. IR sensor
09. DTMF decoder
10. Line Sensor
11. Battery: 8.2 Volts, 750mAh
12. Battery charger: 1
13. Pack of Nuts and Bolts: 1
14. Programming Cable

Experiments:

01. Obstacle Avoiding robot
02. Edge Avoiding Robot
03. Line Following Robot
04. Light Activated Robot
05. Cell Phone Controlled Robot
06. Computer Controlled Robot

Pluton Mini-Arduino Robotic Kit

Order Code - 49542



The controlling part of kit is based around Arduino microcontroller, equipped with motor drivers and ISP facility to program it on board.

Features of mechanical assembly:

01. Laser cut chassis
02. Aluminum brackets
03. 150 Rpm BO motors
04. Special slots for Line sensors

Features of Robot Controller and Modules:

01. AVR Core ATmega8
02. On-board motor drivers, for driving 2 DC motors or 1 stepper motors
03. On board level converter for USB communication
04. On board power regulator
05. Terminal block for easy connection of motors
06. Protection against noise and back EMF
07. Protection against wrong polarity wiring of battery/power supply
08. On-board LEDs for debugging and testing
09. On-board preset for sensor adjustments

Prerequisites:

01. Working Knowledge of C.
02. Syntax and semantics
03. loops and conditions
04. Functions

Package Includes:

01. Microcontroller: Arduino
02. Pack of essential electronic components and ICs
03. Controller PCB:1
04. Aluminum parts; 1 set
05. 150 rpm,12VDC Geared Motors :2
06. Plastic wheels:2
07. Castor Wheels
08. IR sensor

09. DTMF decoder
10. Line Sensor
11. Power Supply
12. Pack of Nuts and Bolts:1
13. Programming Cable

Experiments:

01. Obstacle Avoiding robot
02. Edge Avoiding Robot
03. Line Following Robot
04. Light Activated Robot
05. Cell Phone Controlled Robot
06. Computer Controlled Robot

Mobile Multifunctional Robot

Order Code - 49543



As engineering systems become more complex, robotics education is key in training the modern engineering workforce for the future. This multidisciplinary field provides hands-on design opportunities for future mechanical engineers, electrical engineers, and computer scientists and prepares them for a rapidly growing robotics market.

Features:

01. Computational Device: ATmega8
 - 8 bit RISC MCU
 - 6 Channel, 8 bit PWM
 - Programming Through VPL and C
02. Communication:
 - Zigbee Series II
 - Bluetooth Module: AUBTM
 - Wireless Hand Held Controls
03. Sensors:
 - IR Proximity Sensor: 20 cm
 - Light Sensor
 - Visible Light Sensor
 - Accelerometer
 - Ultrasonic Sensor
04. Modules:
 - DTMF Decoder: 8870
 - RCS Decoder with TV remote

Package Includes:

01. Microcontroller Unit: 1
02. Zigbee Series II: 1
03. Bluetooth Module: 1
04. IR Proximity Sensor: 3
05. Light Sensor: 1
06. Visible Light sensor: 1
07. Accelerometer: 1
08. Ultrasonic sensor: 1
09. DTMF Decoder: 1
10. Interfacing Mother Board: 1
11. Wireless Computer Control Module: 1
12. Geared DC motors: 4
13. Set of switches: Toggle, DPDT etc
14. Software CD: 1
15. Instruction manual: 1
16. USB cable: 1
17. Connecting Leads
18. Battery

19. Battery Charger

List of Experiments:

01. Manual Controlled Robot-Wired
02. Line Following robot
03. Light activated robot
04. PC Controlled Robot- Wireless
05. Obstacle avoider
06. Wireless manual controlled robot
07. Android Controlled Robot
08. Edge Avoider
09. Step programmable robot
10. Speech controlled Robot
11. Ultrasonic based obstacle avoider
12. Cell Phone Controlled Robot
13. Accelerometer based robot

Softbot

Order Code - 49544



This multifunctional platform is ready for your next Software based project. With ability to carry your laptop it significantly reduces the complexities and delays introduced by adding wireless communication modules.

The platform is equipped with 8 Bit AVR microcontroller that directly receives signals from computer through USB and drives motors accordingly.

Developers can also add various sensors modules to make system aware of the environment.

Features:

01. Capable of taking payload of a laptop
02. High performance motors with compatible drivers
03. Special mounting slots for sensors(Not included)
04. On board 8-bit AVR microcontroller
05. Laser cut acrylic chassis
06. Long Life battery.

Package Includes:

01. Chassis with wheels
02. DC Motors
03. Motor driver
04. 8 bit-AVR Microcontroller development board
05. Battery with charger

Pluton Android Based Robotic Platform

Order Code - 49545



The Pluton is high performance robotic platform that can be controlled from your Android smart phone via bluetooth interface. The application on phone is a freeware that can be downloaded from google play. Once programmed user can control the machine from touch switches, voice commands, accelerometer and even joystick .Its truly amazing to see in action. This

economy version of our research level robot is perfect for the hobbist or college robotics labs.

Features:

01. Controlled from Android Phone
02. Bluetooth wireless link
03. Touch switches-Phone
04. Voice control-Phone
05. Accelerometer control-Phone
06. Based on Arduino
07. High performance chassis
08. High ground clearance
09. Rechargeable battery
10. On board motor driver
11. On board Bluetooth module

Package Includes:

01. Aluminum Chassis with tyres
02. 12 VDC geared motors
03. Freeduino USB board w/ ATmega8
04. Bluetooth Module
05. Rechargeable battery
06. Documentation CD
07. USB cable
08. Battery charger

Hand Gesture Recognition And Replication Robot

Order Code - 49546



This intelligent machine will read the sensors mounted on your arm and instruct the robotic arm to move accordingly. This will make the mechanical arm exactly as your own human hand. The sensor used are rotatory position sensors that accurately measures position and speed to human arm. This machine has 4 degrees of freedom ie grip, elbow, shoulder and base. All the arm motors are servo motors that makes the machine precise and accurate.

Features:

01. Based on arduino
02. All servo motors
03. 4 Degrees of freedom
04. Exactly replicate human arm motion
05. High quality aluminum parts
06. High performance aluminum gripper
07. Movable base with geared DC motors

Package Includes:

01. Aluminum Chassis with tyres
02. 12 VDC geared motors
03. Freeduino USB board w/ ATmega8
04. Rechargeable battery
05. Documentation CD
06. USB cable
07. Battery charger

5 Axis Servo based Robotic Arm Trainer Kit

Order Code - 49547



Robotic Arm is a 5 Axis robotic Arm + Servo Gripper. It uses 4 gear servo motors with 5Kg/cm torque and two servo motors with 7Kg/cm torque. Robot Arm has 5 degrees of freedom which includes: Base rotation, Shoulder rotation, Elbow rotation, Wrist pitch and roll. Robotic arm comes preassembled along with versatile servo motor controller which can simultaneously control 6 servo motors with velocity trajectory profile at the same time, an advanced GUI with Interface for robotic ARM motion and 5V-5A SMPS.

Features:

01. 5 Axis articulated robotic arm
02. Special designed gripper
03. Arduino development board with ISP
04. On board 16x2 LCD display
05. Six motor driving ports
06. Many sensor options
07. Wireless control supported
08. Wired remote-control with five switches
09. Manual and computer control options
10. Supports Technido Machine vision module (Not included)
11. Technido human speech control module (NOT included)
12. USB connectivity

Technical Specifications:

Total Degrees of freedom	: 5
Base AOF	: 180° (approximately)
Elbow AOF	: 180° (approximately)
Shoulder AOF	: 180° (approximately)
Base AOF	: 180° (approximately)
Gripper Displacement	: 45 mm linear
Sensor	: Color Sensor (contrast Black/ white)(Included)
	: Accelerometer (optional)
	: Proximity sensor (Included)
Payload	: 50 grams
Resolution	: 5mm+-20%
Repeatability	: 5mm +-20%
Gripper	: Parallel Jaw
Actuators	: Geared DC motor
Weight	: 2 Kg (approximately)

Scoobot NXT

Order Code - 49548



As engineering systems become more complex, robotics education is key in training the modern engineering workforce for the future. This multidisciplinary field provides hands-on design opportunities for future mechanical engineers, electrical engineers, and computer scientists and prepares them for a rapidly growing robotics market.

Features:

01. Computational Device: ATmega8
 - 8 bit RISC MCU
 - 6 Channel, 8 bit PWM

- Programming Through VPL and C
02. Communication:
 - Zigbee Series II
 - Bluetooth Module: AUBTM
 - Wireless Hand Held Controls
 03. Sensors:
 - IR Proximity Sensor: 20 cm
 - Light Sensor
 - Visible Light Sensor
 - Accelerometer
 - Ultrasonic Sensor
 04. Modules:
 - DTMF Decoder: 8870
 - RCS Decoder with TV remote

Package Includes:

01. Microcontroller Unit: 1
02. Zigbee Series II: 1
03. Bluetooth Module: 1
04. IR Proximity Sensor: 3
05. Light Sensor: 1
06. Visible Light sensor: 1
07. Accelerometer: 1
08. Ultrasonic sensor: 1
09. DTMF Decoder: 1
10. Interfacing Mother Board: 1
11. Wireless Computer Control Module: 1
12. Geared DC motors: 4
13. Set of switches: Toggle, DPDT etc
14. Software CD: 1
15. Instruction manual: 1
16. USB cable: 1
17. Connecting Leads
18. Battery
19. Battery Charger

5 Axis Robotic Arm Trainer Kit With Voice Control

Order Code - 49549



8.7 Million is the total number of industrial robots in the world, many of us might not have seen even single industrial robot. Technido brings you an opportunity to have a feel of real 5 axis industrial robot in your own laboratory at most affordable price.

Features:

01. 5 Axis articulated robotic arm
02. Special designed gripper
03. Arduino development board with ISP
04. On board 16x2 LCD display
05. Six motor driving ports
06. Wired remote-control with five switches
07. Manual and computer control options
08. Technido human speech control module (included)
09. USB connectivity

Technical Specifications:

Total Degrees of freedom	: 5
Base AOF	: 270° (approximately)
Elbow AOF	: 300° (approximately)
Shoulder AOF	: 180° (approximately)
Base AOF	: 270° (approximately)
Gripper Displacement	: 45 mm linear

Sensor	: Color Sensor (contrast-Black/white)(Included)
	: Accelerometer (optional)
	: Proximity sensor (Included)
Payload	: 50 grams
Resolution	: 5mm+-20%
Repeatability	: 5mm +-20%
Gripper	: Parallel Jaw
Actuators	: Geared DC motor
Weight	: 2 Kg (approximately)

Quark-Servo based hexapod

Order Code - 49550



The Quark round body symmetry makes this a very unique hexapod walker. The three DOF (degree of freedom) leg design provides the flexibility required to walk in any direction! The robot uses 18 HS-475 / HS-485 or equivalent servos for the legs. The combo kit includes everything you need to make a functional robot plus batteries. This is one of our most sophisticated walking robot offerings.

It's truly amazing to see in action. This economy version of our research level robot is perfect for the hobbyist or college robotics labs.

Specifications:

- * Processing
- * ATmega8 based Arduino Compatible Board
- * DOF for each leg: 3
- * Actuator: Servo Motor
- * Total Number of Legs: 6

Communication:

- * USB 2.0 Wired Communication
- * Development Application:
- * Full development kit including SDK, data protocol and sample codes.

Others:

01. Rechargeable Battery: Li-Po 6V , 2AH
02. Battery Charger
03. Documentation and tutorials
04. Necessary set of tool kit
05. All required cables and connectors

Research Robot Plutonx

Order Code - 49551



The Pluton X is a popular research mobile robot. Its versatility, reliability and durability have made it the reference platform for robotics research. Unlike hobby and kit robots, It is fully programmable, and will last through years of tough classroom and laboratory use.

Computational Block: Mamba Dual-Core

Computer

01. Microcontroller: CPU: dual-core 2.26 GHz 32-bit Intel Core 2 Duo P8400
02. Flash : Ethernet: dual 10/100/1000 ports
03. USB: six USB 2.0 ports with standard connectors
04. Serial: four RS-232 serial ports (two of which are RS-422 capable)
05. Generic digital I/O: 32 with SPI interface
06. Generic analog I/O: 8 inputs, 4 outputs with SPI interface
07. Disk: 40GB solid state SATA (computer supports two SATA devices)
08. OS Preinstalled and configured: Linux or Windows XP Embedded
09. 2 X PC/104+ Slots
10. Fire Wire : IEEE 1394

Sensors

Rear Sonar Sensors- 3 Units

01. Supply Voltage – 5 VDC
02. Supply Current – 30 mA typ; 35 mA max
03. Range – 2 cm to 4 m
04. Input Trigger – positive TTL pulse, 2 uS min, 5 ms typ.
05. Burst Frequency – 40 kHz for 200 ms
06. Burst Indicator LED shows sensor activity
07. Delay before next measurement – 200 ms

WiFi to UART Module : High Speed Wireless Ethernet

01. Data Rate : 11M bps
02. Support the STA applications in the infrastructure network
03. Support the OPEN/WEP mode authentication
04. Support the WEP64/WEP128/CCMP/WPI data encryption

Others:

01. Rechargeable Battery: Li-Po 11.1V , 7Amp/HR
02. Battery Charger
03. Switching Interface
04. Rework docking station
05. Documentation and tutorials
06. Necessary set of tool kit
07. All required cables and connectors
08. SD MMC card holder
09. Expansion headers for GPIOs, I2C, SPI,UARTs, Power etc.
10. 4 switches and 4 LED displays

Communication:

Zigbee : 60mW with Wire Antenna : 2 Units

01. 3.3V @ 215mA
02. 250kbps Max data rate
03. 60mW output (+18dBm)
04. 1 mile (1500m) range
05. AT or API command set
06. USB interface adapter

USB 2.0 Wired Communication

RS232 wired Communication

Indications

01. Indicator LEDs
02. Piezo Electric Buzzer

Development Application:

01. Development Support: Eclipse

02. Serial protocol based firmware for accessing robot data and controlling the robot via Matlab / Labview / Beagle board / ARM based board etc

GOLBO-SWARM Robotics Research Platform

Order Code - 49552



The machine is small, low powered indoor moving platform. 3 wheels drive mobile robot utilizing omni wheels. It is capable of moving in any direction by changing the velocity and direction of each wheel without changing its orientation. It includes microcontroller, IO expansion board, DC motor with encoder, IR and ultrasonic sensors and pre-drilled screw holes.

- Microcontroller : Atmel ATmega328
- Flash (Kbytes) : 32 Kbytes
- Operating Frequency : 20 MHz
- CPU : 8-bit
- I/O Pins : 20
- Ext Interrupts : 24
- SPI : 1
- TWI (I2C) : 1
- UART : 1
- ADC channels : 5
- ADC Resolution (bits) : 10
- ADC Speed (ksps) : 15
- Analog Comparators : 1
- SRAM (Kbytes) : 1
- Self Program Memory
- I/O Supply Class : 1.8 to 5.5
- Operating Voltage (Vcc) : 1.8 to 5.5
- Programming : ISP programmable with Onchip code transfer program.

USB interface for downloading hex codes

Sensors:

Line Finder 1 Units Array of 5

- * Power supply : 5 VDC
- * Indicator LED
- * Output: Analog/ digital
- * Sensing Distance: Adjustable
- * 3mm screw hole for mounting

Ultrasonic range finder - 3 Units

- * Supply Voltage 5 VDC
- * Supply Current 30 mA typ; 35 mA max
- * Range 2 cm to 4 m
- * Input Trigger positive TTL pulse, 2 uS min, 5 uS type.
- * Burst Frequency 40 kHz for 200 uS
- * Burst Indicator LED shows sensor activity
- * Delay before next measurement 200 uS

Analog IR distance sensor- 1 Units

- * Operating voltage: 4.5 V to 5.5 V
- * Average current consumption: 30 mA (typical)
- * Distance measuring range: 10 cm to 80 cm (4" to 32")
- * Output type: analog voltage
- * Response time: 38 ± 10 ms

Wheel:

- * Type: 90° Omni wheel

- * Material: Nylon or Aluminium Alloy
- * Load Capacity : 15kg
- * Material : Rubber or Nylon
- * Coupled Mode: Brass Tube or bearings

Communication:

- * Zigbee : 60mW with Wire Antenna : 2 Units 3.3V @ 215mA
- * 250kbps Max data rate
- * 60mW output (+18dBm)
- * 1 mile (1500m) range
- * Fully FCC certified
- * 6, 10-bit ADC input pins
- * 8, digital IO pins
- * 128-bit encryption
- * Local or over-air configuration
- * AT or API command set
- * USB interface adapter
- * USB 2.0 Wired Communication
- * RS232 wired Communication

Compass:-

- * Resolution: 400µG Minimum
- * Offset (°) from North 2° Typical

Indications

- * 16X2 Alphanumeric Display
- * Indicator LEDs
- * Piezo Electric Buzzer

Development Application:

- * Sample codes: Supporting Microsoft ® Robotics Studio, Microsoft ® Visual Studio, MATLAB ®.

Others:

01. Rechargeable Battery: Li-Po 11.1V , 5AH
02. Battery Charger
03. Switching Interface
04. Rework docking station
05. Documentation and tutorials
06. Necessary set of tool kit
07. All required cables and connectors

Fibre Optic Set

INTRODUCTION AND APPLICATION OF FIBRE OPTICS

HISTORY OF FIBRE

In 1870, John Tyndall demonstrated that light follows the curve of a stream of water pouring from a container, it was this simple principle that led to the study and development of applications for this phenomenon. John Logie Baird patented a method of transmitting light in a glass rod for use in an early colour TV, but the optical losses inherent in the materials at the time made it impractical to use. In the 1950's more research and development into the transmission of visible images through optical fibre led to some success in the medical world, as they began using them in remote illumination and viewing instruments. In 1966 Charles Kao and George Hockham proposed the transmission of information over glass fibre, and they also realised that to make it a practical proposition, much lower losses in the cables were essential. This was the driving force behind the developments to improve the optical losses in fibre manufacturing, and today optical losses are significantly lower than the original target set out by Charles Kao and George Hockham.

TYPES OF FIBRE

- 01. Step-Index multi mode Fibre
- 03. Plastic Fibre
- 05. Step - Index single mode Fibre
- 07. Dispersion - Flattened Single mode Fibre
- 09. Sen Sing and special-purpose Fibre
- 11. NID - Infrared Fibre
- 02. Ultraviolet Fibre
- 04. Graded - Index multi mode Fibre
- 06. Dispersion - Shifted Single mode Fibre
- 08. Polarization - Sensitive Fibre
- 10. Bundled Fibre

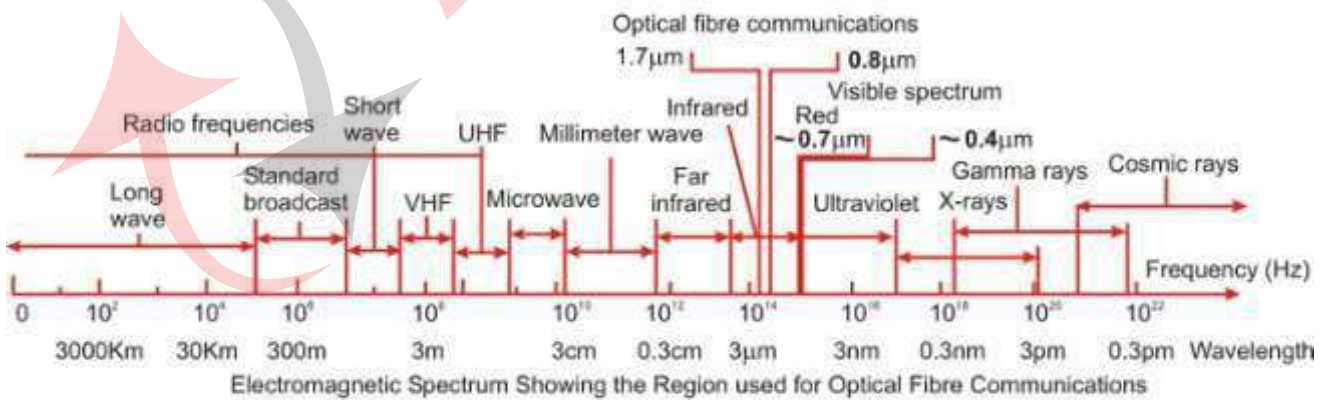
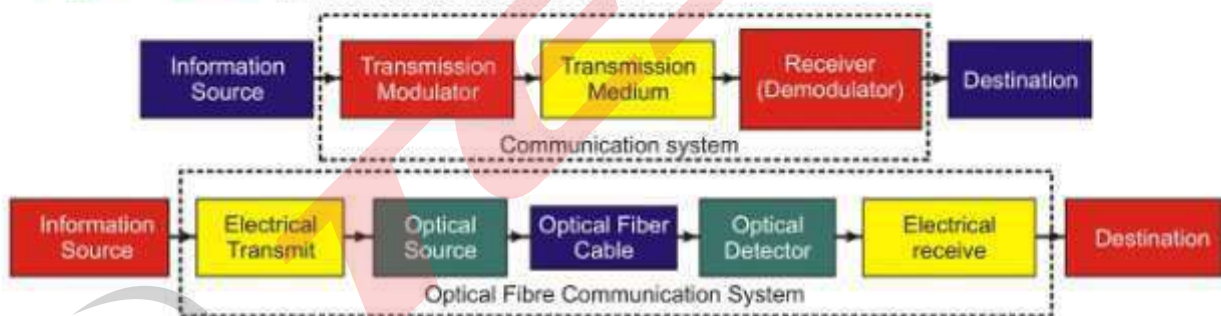
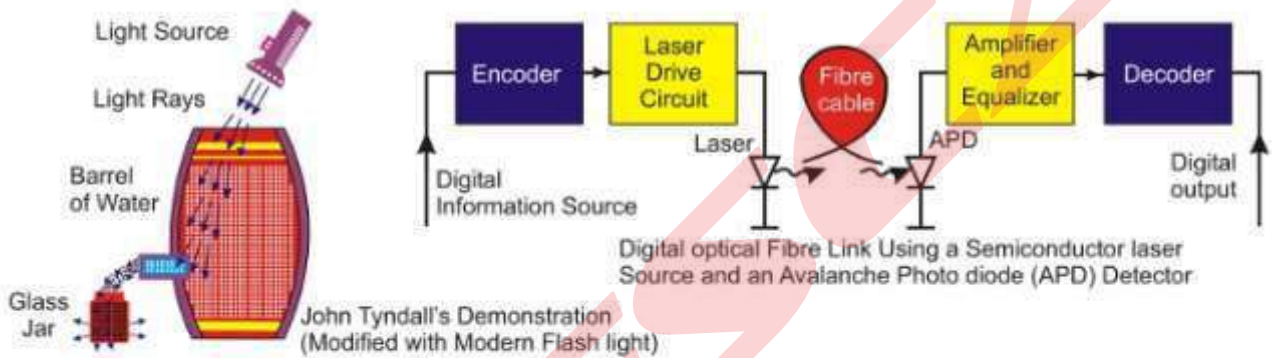

APPLICATION :-

- 01. Analog and Digital Communication,
- 03. Long Distance Tele communication
- 05. Computer Data Communication
- 07. Ships, Auto Mobiles, and Airplanes
- 09. Illumination
- 11. Sensors
- 02. Converting Analog and Digital signal
- 04. Satellites for Inter - continental Communication
- 06. Video Trans mission
- 08. Military Systems
- 10. Imaging and Inspection

Microprocessor Set

8085A 8-BIT MICROPROCESSOR

- Single + 5V power supply.
- 100 % Software compatible with 8080A.
- 1.3 uS instruction cycle (8085A); 0.8 uS (8085A-2)
- On-chip clock generator (with external crystal, LC or RC network)
- On-chip system controller ; Advanced cycle. status information available for large system control.
- Four vectored interrupt inputs (one is non-maskable) plus an 8080A compatible interrupt.
- Serial in / serial out port.
- Decimal, Binary and double precision arithmetic.
- Direct addressing capability to 64k Bytes of memory.

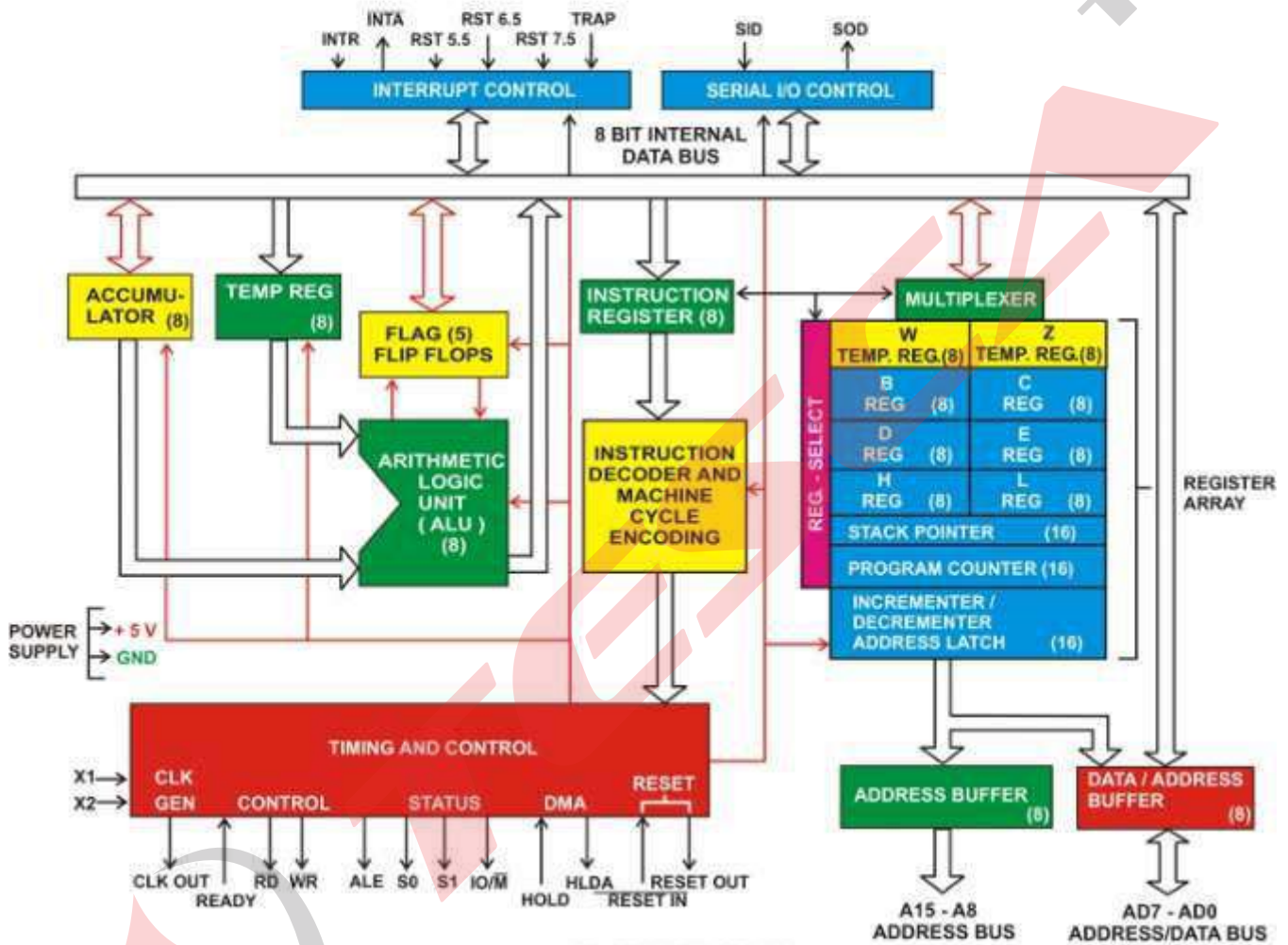

BLOCK DIAGRAM



PIN CONFIGURATION

Physics Set

INTRODUCTION TO PHYSICS

Physics is the science of matter and its motion as well as space and time. It is the science that deals with concepts such as force, energy, mass, and charge. Physics is an experimental science. It is the general analysis of nature. Research is often divided into four subfields: condensed matter physics; atomic, molecular, and optical physics; high-energy physics; and astronomy and astrophysics.

Although physics encompasses a wide variety of phenomena, the fundamental branches of physics are classical mechanics, electromagnetism quantum mechanics and Relativistic Mechanics. Classical mechanics correctly describes the motion of objects in everyday experience, but it breaks down at the atomic scale, where it is superseded by quantum mechanics, and at speeds approaching the speed of light, where relativistic effects become important.

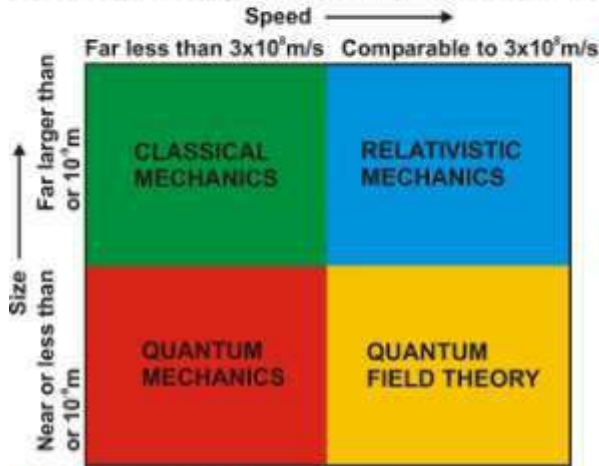

Fundamental topics of Physics:

Classical Mechanics

Classical mechanics is used for describing the motion of macroscopic objects, from projectiles to parts of machinery, as well as astronomical objects. For simplicity, it often models real-world objects as point particles, objects with negligible size.

Newton Third Law of motion:

To every action there is an equal and opposite reaction. They act simultaneously, but act on different bodies.

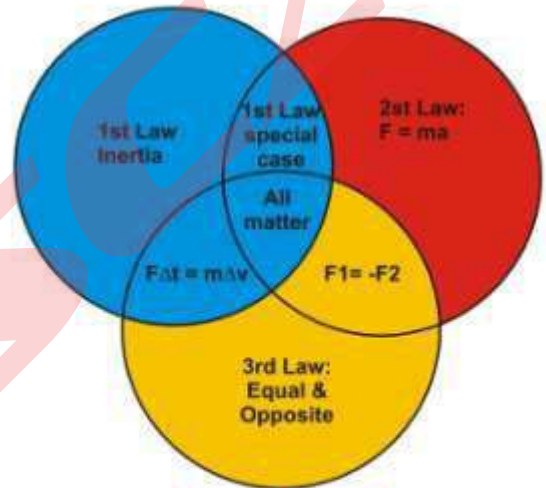

Newton's Laws

Waves and Oscillations

Oscillation is the repetitive variation, typically in time, of some measure about a central value or between two or more different states. The simplest mechanical oscillating system is a mass attached to a linear spring, subject to no other forces; except for the point of equilibrium, this system is equivalent to the same one subject to a constant force such as gravity.

A Wave is a disturbance that propagates through space and time, usually with transference of energy. While a mechanical wave exists in a medium, waves of electromagnetic radiation can travel through vacuum, that is, without a medium

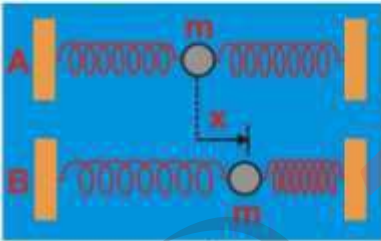

Magnetic effects of Current and Magnetism

In physics, Magnetism is one of the phenomena by which materials exert attractive or repulsive forces on other materials. Magnetism also has other manifestations in physics, particularly as one of the two components of electromagnetic waves such as light.

P = Power V = Voltage

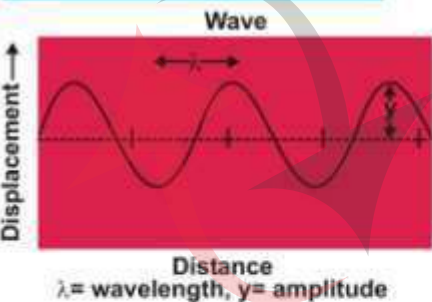

λ = wavelength, y = amplitude



I = Current R = Resistance

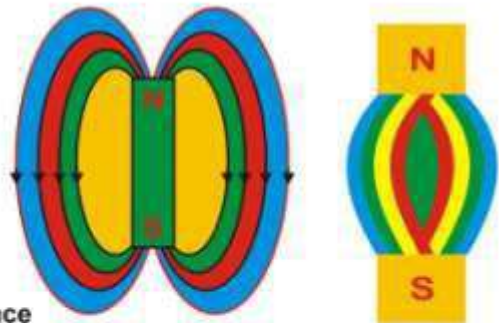

Current Electricity and Thermoelectric effects

Electricity is a general term that encompasses a variety of phenomena resulting from the presence and flow of electric charge. These include many easily recognizable phenomena such as Current and Static electricity. Electric current is the movement or flow of electrically charged particles, typically measured in amperes.

Electrostatics

Electrostatics is the branch of science that deals with the phenomena arising from what seems to be stationary electric charges. Electrostatic phenomena arise from the forces that electric charges carry out on each other.

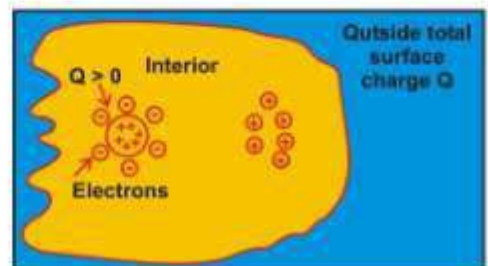

Power Electronics Set

POWER ELECTRONICS AT A GLANCE

Power Electronics deals with the use of electronics for control and conversion of large amounts of electric power from one form to another. The block diagram shows the dynamic power circuit controlling the amount of power flow from the source to the load through control circuit parameters. Main power source may be an AC supply system or a DC supply system. The output from the power electronic circuit may be variable DC or AC voltage or it may be a variable voltage and frequency. The feedback component measures a parameter of the load and compares it with the command. The difference of two, through the digital circuit components, controls the instant of turn - on of semiconductor devices forming the solid-state power converter system.

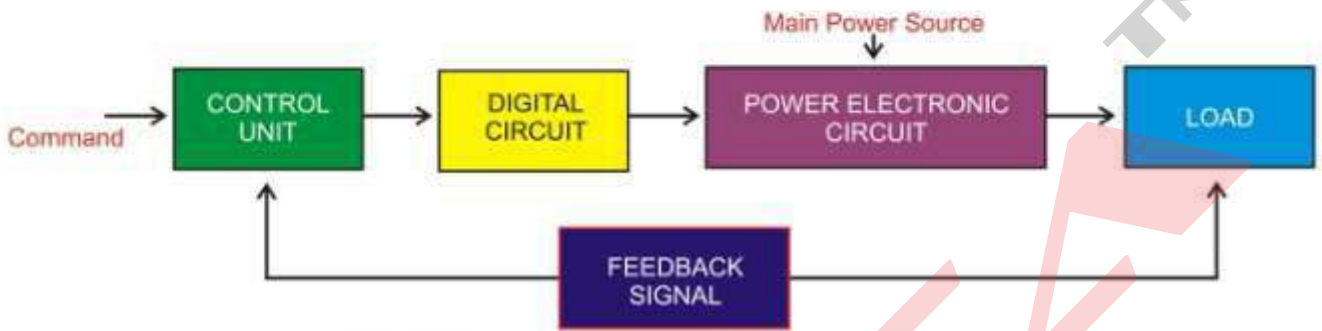

Block Diagram of a Typical Power Electronic System

AREAS OF SPECIALIZATION :-

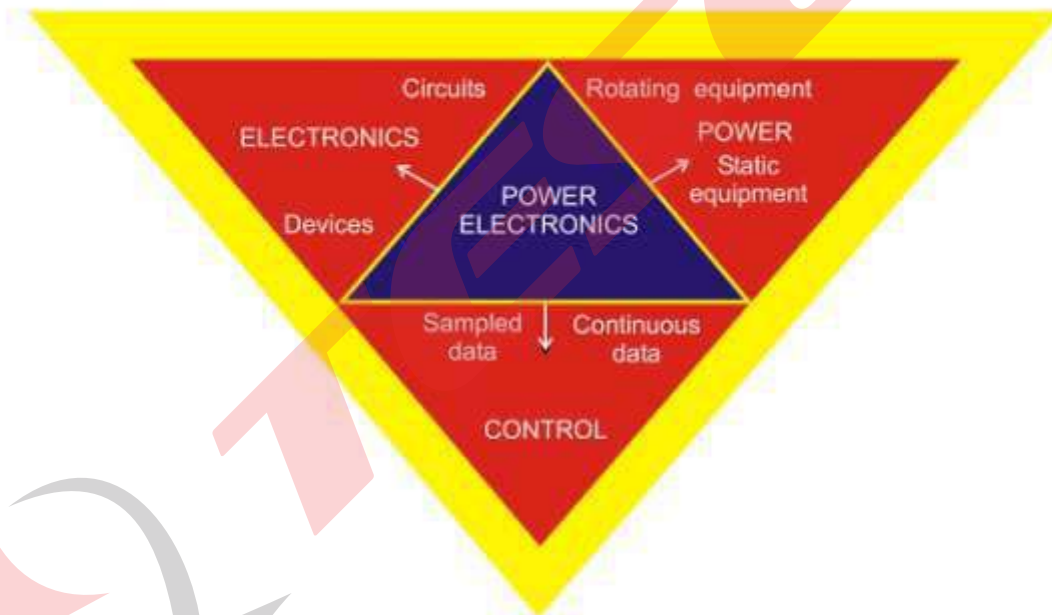

ELECTRONICS :- Electronics deals primarily with devices and circuits for processing information.

POWER :- Power deals with both rotating and static equipment for the Generation, Transmission, Distribution and Utilisation of vast quantities of electric power.

CONTROL :- Control deal with the stability and response characteristics of closed loop systems using feedback on a continuous / sampled data basis.

- ADVANTAGE** :-
1. High efficiency
 2. High Reliability
 3. Long life and less maintenance
 4. Fast dynamic response
 5. Small size and less weight
 6. Low cost

- DISADVANTAGE** :-
1. Generate harmonics in the supply system
 2. Low input power factor
 3. Low overload capacity
 4. Regeneration of power is difficult

- APPLICATION AREAS** :-
- | | |
|----------------------|-------------------|
| 1. Aerospace | 2. Commercial |
| 3. Industrial | 4. Residential |
| 5. Telecommunication | 6. Transportation |
| 7. Utility systems | |

Work Station ESD Safe -120 x 60 x 180 cm

Order Code - 78001



Today's electronic manufacturers need a workstation designed to help reduce harmful discharges from reaching vulnerable parts and assemblies. Part of the overall solution is to have a workstation designed with the proper grounding system to dissipate any charge away from the product you're producing. Our custom made workstations are designed to withstand the toughest of environments, allow total flexibility for future upgrades and meet your organization's ESD needs.

Special Size Available on Request

Standard Features

01. Table Top Size 120 x 60 cm; Overall Height 180 cm
02. Workstation structure made from 20 x 40mm rectangular pipes of 18 Gauge. Available in powder coated grey colour.
03. ESD Mat for table top with grounding cord.
04. Universal spike protector 230V / 50Hz, 15 Amps with four sockets.
05. Four conductive leveling screws for base with height adjustment facility.
06. Foot rest for user convenience
07. 28 W flicker free swivel Light
08. Louver panel
09. Conductive Bins
10. Writing & Felt Board
11. Tool Tray with option of fitting on Left or Right side
12. Modular System with lock
13. Special sizes available on request.

Work Station ESD Safe -120 x 60 x 150 cm

Order Code - 78002



Today's electronic manufacturers need a workstation designed to help reduce harmful discharges from reaching vulnerable parts and assemblies. Part of the overall solution is to have a workstation designed with the proper grounding system to dissipate any charge away from the product you're producing. Our custom made workstations are designed to withstand the toughest of environments, allow total flexibility for future upgrades and meet your organization's ESD needs.

Special Size Available on Request

Standard Features

01. Table Top Size 120 x 60 cm; Overall Height 150 cm

02. Workstation structure made from 20 x 40mm rectangular pipes of 18 Gauge. Available in powder coated grey colour.
03. ESD Mat for table top with grounding cord
04. Universal spike protector 230V / 50Hz, 15 Amps with four sockets
05. Four conductive leveling screws for base with height adjustment facility
06. Foot rest for user convenience Optional Accessories 28 W flicker free swivel Light
07. Louver panel
08. Conductive Bins
09. Tool Tray with option of fitting on Left or Right side
10. Modular System with lock
11. Special sizes available on request

Component Organiser - 25 Drawers

Order Code - 78003



Component Organiser:

- * Ideal for storing electronic parts, hardware etc
- * Suitable for homes workshops and factories
- * Comes with clear see through plastic drawers for easy visibility of contents
- * Comes with 25 Drawers, 5 Each in Row and Column

Cabinet Size:

- * 400mm x 250mm x 160mm

Size of Drawers:

- * 150mm x 75mm x 35mm

Electronics/Electrical Work Bench

Order Code - 78004 - 78005



Assembly: Table made from 3 sub assemblies a) Bottom stand Pi type structure with table top, drawers etc. b) Hind rectangular box, also called as switch box, to hold 1ph. & 3ph. power sources etc. C) Optional top side rectangular box mounted on top of hind or switch box to house various instruments like CRO, FG, & power supplies etc.

Frame: 16 gage MS square tube (Heavy duty) Color: Brown/off white powder coating, optionally with sturdy aluminum profile frame.

Table top Material/Colour: The nova pan or Rubber wood with white / silver gray colour & smooth finish, Veneer finish table top (18 mm thickness)

Drawer: Drawers to have position options: Horizontal (optional) or vertical (Default). Horizontal drawers have restriction of height else they will obstruct knees of tall person while sitting in front of tab. Vertical drawer

has limitation of no. of students which can be accommodated in front of table i.e. only one but advantage here is bottom drawer can be heighted · Out of 3 drawers, one is open type & would double up as PC keyboard drawer with mouse pad on its side. Other two drawers are closed type, lockable. Of these two. bottom drawer has double height to accommodate tall (pneumatic /hydraulic) components. · Pull out writing pad provided above upper drawer on right hand side of table. · Dimensions - Upper Drawer : 600mm (L) X 400 (W) X 200mm (H), Tall Drawer : 600mm (L) X 400(W) X 20mm (H), Open Drawer : 700mm (L) X400mm (W) X045mm (H), Writing pad : 335mm (L) X 300mm (W) X010 0mm (H)

Bottom Legs: Four rubber bottom legs are provided support the table optionally Castor wheel with locking mechanism is provided so that table can be easily moved.

Dimensions Overall: 1200mm (L) X 750mm (W) X 1325mm (H), Nt. Wt. 190kg, Gr. Wt.230kg

Electrical: Hind (Switch) box with screwable hind side panel to facilitate wiring & controlling 6 separate sets of 5 Amp switch & 5 pin 3 phase proof protective Socket with 4pole MCB Neon indicator provided on the facing panel of switch box.

Electronics Bench - Order Code - 78004

DC Power supplies

Regulated DC Power supply : XPO RPS consisting of 2 Meters select to read voltage/current of each output for dual Power supply (0 30V). Ripple & Noise : <2mVrms Output current: max rated Current with over load RED LED indication. Regulation : Line :<0.01% 2mV for load change from zero to full load Ripple & Noise : <1mV rms max Indication, Constant Current Mode output Range :0 to RATED CURRENT continuously adjustable Regulation. Line <0.1%+250uA for +10% change in line. Load : <0.1%+250uA for change in output voltage from 0 to max.

Multifunction Meters

3 3/4 Digital multimeter

Technical Specification: 3/4 Digital multimeter, 4000 Counts, Large LED Display with Auto/Manual Range, power off under natural operation. Data Hold, Max.,<in. Value Hold, Capacitance, Frequency / Duty Cycle, Temperature and Transistor Test Transistor Test

Technical data

Basics Functions	Range	Basics Accuracy
DC Voltage	0.1mV~1000V	±(0.5%+4digit)
AC Voltage	0.8%~750V	±(0.5%+6digit)
DC Current	0.1uA~20A	±(1.0%+5digit)
AC Current	0.1uA~20A	±(1.5%+5digit)
Resistance	0.1 ohm~40Mohm	±(0.8%+2digit)
Capacitance	10pF~200pF	±(3.5%+8digit)
Frequency	0.1Hz~30MHz	±(0.5%+4digit)
Celcus	-40°C~1000°C	±(0.8%+4digit)
hhFE(NPIN ro PNP)	0~1000	----

Measuring Instruments

A] 25 MHz Colour LCD Digital Storage oscilloscope Sampling: ACQU Mode: Sample, Average Sampling Rate100MS/s.

Input Coupling:

DC, AC, Input , Impedance :1M_±2%, connect-ed with 20pF ± pF in parallel., Max Input voltage Level :300V, Peak value. Sampling Rate Range :10S/s~100MS/S

Record Length:

6000 sampling points per channel Scanning Speed Range (s/div) : 5ns/div~5ns/div, according to the stepping mode of 1- 2.5. Measuring accuracy of time.

Display Type:

7.8" Colored LCD (Liquid Crystal Display) Display Colors 56 Colours. Power Mains voltage : 100~240 VAC RMS, 50Hz. Accessories: 1) Mains cord: 01 Nos 2) X1, X10CRO Probe:02Nos 3) Aligner: 01 Nos 4) USB Cable: 01 Nos 5) Manual: 01Nos

B] 3 MHz Function Generator with 50MHz Frequency counter

Sine, Triangle, Square, duty cycle. Pulse and Ramp. Wide frequency ranges. Frequency/Universal counter & voltmeter. With internal & external frequency counter upto 50MHz, AM/FM Frequency Range : 0.03 MHz to 3 MHz. aveform: Sine square, Triangle, Accuravy+1% plus 1digit, Maximum Output level : 20Vpp & 10Vpp into 50W, Sine wave Disttion : <1% typical <100KHz; 3%>100KHz

Electrical Bench - Order Code - 78005

DC Power supplies

1) Regulated DC Power Supply: RPS Cosisting of 2 meters select to read voltage/current of each output for dual power supply (0-30V). Ripple & Noise: <2mVrms output current : Max rated current with over load RED LED indication. Regulation: Line <0.01% ± 2mV for 10% change in line, load: <0.01% ± 2mV for load change from zero to full load Ripple & Noise: <1mV rms max Indication.

2) 3 phase Auto Transformer: 0 440B / 5AVoltage : 0 - 440V., Current: 5A

3) Unregulated variable DC supply: 0 300 VD/5A, Voltage : 0 - 300VDC variable current 5A

Pair Patch Cord Stakcable Spring Loaded Plug

Order Code - 77001 - 77002

**Order Code - 77001**

Patch Cord one end 2mm stakcable banana plug & other end Insulated crocodile clip

Specification:

Material : Brass nickle plated
Wire : 23 strands of 38 SWG, 3.0 mm O.D
Colour : Red, Black, Blue, Green, Yellow,

Order Code - 77002

Patch Cord one end 4mm stakcable banana plug & other end Insulated crocodile clip

Specification:

Material : Brass nickle plated
Wire : 80 strands of 42 SWG, 3.8 mm O.D
Colour : Red, Black, Blue, Green, Yellow,

Connecting Jumper Wire Cable

Order Code - 77201A - 77201D

**Description:**

Jumper wires are simple wires that have connector pins at each end, allowing them to be used to connect two points to each other without soldering. Jumper wires are typically used with breadboards and other prototyping tools in order to make it easy to change a circuit as needed. Fairly simple. In fact, it doesn't get much more basic than jumper Wires.

Technical Specification:

Type : Male to Male, Female to Female, Male to Female
Line : Customize
Pitch : 2.54mm
Color : Colorful
Material : Plastic

Order Code	Description
77201A1	10 Connecting Jumper Wire Male to Male - 12cm
77201A2	10 Connecting Jumper Wire Female to Female - 12cm
77201A3	10 Connecting Jumper Wire Male to Female - 12cm
77201B1	10 Connecting Jumper Wire Male to Male - 16cm
77201B2	10 Connecting Jumper Wire Female to Female - 16cm
77201B3	10 Connecting Jumper Wire Male to Female - 16cm
77201C1	10 Connecting Jumper Wire Male to Male - 20cm
77201C2	10 Connecting Jumper Wire Female to Female - 20cm
77201C3	10 Connecting Jumper Wire Male to Female - 20cm
77201D1	10 Connecting Jumper Wire Male to Male - 24cm
77201D2	10 Connecting Jumper Wire Female to Female - 24cm
77201D3	10 Connecting Jumper Wire Male to Female - 24cm

Soldering and De-Soldering Stations

Order Code - 72001 - 72011

We are a leading and also pioneer in developing for the first time in India a soldering station with imported ceramic heater element with micro controller based and de-soldering stations and digital rework stations which are a must for any R & D lab and production facility. After carefully studying for over a decade, and with due consultation with different customers in labs, production, R & D, after years of trial and error, a very unique table top work station, which has unbelievable nine different operations with which operator can rework any sort printed circuit efficiently. (SMD + PTH REWORK). The Units we have developed have very unique features and also with high utility and very long life, perhaps these units are serviceable for the first time in indigenous industry.

Soldering Station with Indigenous Heater

Order Code - 72001 (60W) - 72002 (90W)



Specifications:

Temperature Range	: 180-480°C
I/P Voltage	: 190-270VAC
O/P Voltage	: 24 VAC
Max Power	: 60 -90 Watts
Time to temperature Rising	
From ambient - 350°C	: 45 Sec.
Heater Type	: Ceramic
Tip to ground Resistance	: < 0.2 Ohms
Tip to ground potential	: < 2mV
Auto Sleep Function	: No
Temperature Lock mode	: Optional
Application	: High Mass Components Solar PV Cells

Soldering Station with Japanese Ceramic heater

Order Code - 72003



Features :

01. Auto turn PID Control Circuit
02. Ease of operation
03. Set / Read of Operation
04. Separate switches for increase & decrease of temperature, after two seconds the actual read of temp will display
05. Intelligent Power management auto stand by on mains interruption to save power
06. Temperature control accuracy $\pm 1^\circ\text{C}$
07. If sensor fails power to the element is shut off
08. Burn proof silicon cable thermal resistance up to 600 °C

Specifications:

Temperature Range	: 180-480°C
I/P Voltage	: 190-270VAC
O/P Voltage	: 24 VAC
Max Power	: 60 Watts
Time to temperature Rising	
From ambient - 350°C	: 45 Sec.
Heater Type	: Ceramic
Tip to ground Resistance	: < 0.2 Ohms
Tip to ground potential	: < 2mV
Auto Sleep Function	: No
Temperature Lock mode	: Optional
Application	: General

Accessories :

- | | | |
|---------------------------|-------|-------|
| 01. Control Unit | ----- | 1 No. |
| 02. Stand | ----- | 1 No. |
| 03. Soldering Iron Handle | ----- | 1 No. |
| 04. Cleaning Sponge | ----- | 1 No. |

Soldering Station with Japanese Ceramic heater

Order Code - 72004



Features :

01. Auto turn PID Control Circuit
02. Ease of operation
03. Set / Read of Operation
04. Separate switches for increase & decrease of temperature, after two seconds the actual read of temp will display
05. Intelligent Power management auto stand by on mains interruption to save power
06. Temperature control accuracy $\pm 1^\circ\text{C}$
07. If sensor fails power to the element is shut off
08. Burn proof silicon cable thermal resistance up to 600 °C

Specifications:

Temperature Range	: 180-480°C
I/P Voltage	: 190-270VAC
O/P Voltage	: 24 VAC
Max Power	: 60 Watts
Time to temperature Rising	
From ambient - 350°C	: 45 Sec.
Heater Type	: Ceramic
Tip to ground Resistance	: < 0.2 Ohms
Tip to ground potential	: < 2mV
Auto Sleep Function	: No
Temperature Lock mode	: Optional
Application	: General

Accessories :

- | | | |
|---------------------------|-------|-------|
| 01. Control Unit | ----- | 1 No. |
| 02. Stand | ----- | 1 No. |
| 03. Soldering Iron Handle | ----- | 1 No. |
| 04. Cleaning Sponge | ----- | 1 No. |

Lead Free Soldering Station (100W)

Order Code - 72005



Features :

01. Auto turn PID Control Circuit
02. Ease of operation
03. Set / Read of Operation
04. Separate switches for increase & decrease of temperature, after two seconds the actual read of temp will display
05. Intelligent Power management auto stand by on mains interruption to save power
06. Temperature control accuracy $\pm 1^{\circ}\text{C}$
07. If sensor fails power to the element is shut off
08. Burn proof silicon cable thermal resistance up to 600°C

Specifications:

Temperature Range	: 180-480°C
I/P Voltage	: 190-270VAC
O/P Voltage	: 30 VAC
Max Power	: 100 Watts
Time to temperature Rising	
From ambient - 350°C	: 25 Sec.
Heater Type	: Ceramic
Tip to ground Resistance	: < 0.2 Ohms
Tip to ground potential	: < 2mV
Auto Sleep Function	: Yes
Temperature Lock mode	: Optional
Application	: Lead Free Soldering

Accessories :

01. Control Unit -----1 No.
02. Stand -----1 No.
03. Soldering Iron Handle-----1 No.
04. Cleaning Sponge -----1 No.

De-Soldering Station

Order Code - 72006



Specifications:

Temperature Range	: 180-480°C
I/P Voltage	: 190-270VAC
O/P Voltage	: 24 VAC
Max Power	: 60 Watts
Temp. Accuracy	: $\pm 1^{\circ}\text{C}$
Tip to ground potential	: Under 2M.V
Tip to ground Leakage	: Under 2
Vacuum	: 600 mm/Hg.
High Quality 24V DC Pump with 4000 RPM	

Accessories :

01. Control Unit -----1No.
02. Soldering Iron-----1No.
03. De-Soldering Iron -----1No.
04. Combined Soldering & De-Soldering Stand ---1No.
05. Power Cord-----1No.

Tool Box Containing :

01. Primary Filter -----15 Nos
02. Secondary Filters -----5 Nos
03. Silicon Washer Set -----1Set
04. Glass Tube-----1No.
05. Nozzle Cleaning Spring -----1No.

Soldering & De-Soldering Station

Order Code - 72007



Specifications:

Temperature Range	: 180-480°C
I/P Voltage	: 190-270VAC
O/P Voltage	: 24 VAC
Max Power	: 70 Watts
Temp. Accuracy	: $\pm 1^{\circ}\text{C}$
Tip to ground potential	: Under 2MV
Tip to ground Leakage	: Under 2
Vacuum	: 600 mm/Hg.
High Quality 24V DC Pump with 4000 RPM	

Accessories :

01. Control Unit -----1No.
02. Soldering Iron-----1No.
03. De-Soldering Iron -----1No.
04. Combined Soldering & De-Soldering Stand ---1No.
05. Power Cord-----1No.

Tool Box Containing :

01. Primary Filter -----15 Nos
02. Secondary Filters -----5 Nos
03. Silicon Washer Set -----1Set
04. Glass Tube-----1No.
05. Nozzle Cleaning Spring -----1No.

SMD Rework Station

Order Code - 72008



Specifications:

Specifications	: (SMD Hot Air)
Input Voltage	: 220 V AC
Power Consumption	: 300 Watts
Air Pump	: Diaphragm type
Capacity	: 24 L/min
Hot Air Temperature	: 200 to 550
Temp Accuracy	: $\pm 1^{\circ}\text{C}$
Motor will switch off automatically after reaching 100°C when the element is switched off	

Accessories : 2 In One Unit

01. Control Unit-----1No.
02. SMD Hot Air Iron -----1No.
03. Soldering Iron-----1No.

- 04. Soldering Iron Stand ----- 1No.
- 05. SMD Hot Air Stand ----- 1No.
- 06. Single Hole Nozzle ----- 1No.

Digital Rework Station 3 in one

Order Code - 72009



Specifications:

- Input Voltage : 190 V 270V
- Output Voltage : 24V AC
- Soldering/De-Soldering (W) : 60 / 70 watts
- Temp Range : 180-480°C
- Temp Accuracy : ± 1°C
- Tip to ground Potential : Under 2 MV
- Tip to ground Leakage : under 2
- Vacuum : 600mm/Hg
- High Quality 24V DC Pump with 4000 RPM

SMD Hot Air

- Input Voltage : 220 V AC
- Power consumption : 300 Watts
- Air Pump : Diaphragm Type
- Capacity : 24 L/min
- Hot Air Temperature : 200 to 550
- Temp Accuracy : ± 1°C
- Motor will switch off automatically after reaching 100°C when the element is switched off

Accessories :

- 01. Control Unit ----- 1 No.
- 02. Soldering Iron ----- 1 No.
- 03. De-Soldering Iron ----- 1 No.
- 4. SMD Hot Air Iron Combined Soldering & de-Soldering Stand ----- 1No.
- 05. SMD Hot Air Stand ----- 1No.
- 06. Power Cord ----- 1No

Tool Box Containing

- 01 Primary Filter ----- 15 Nos
- 02. Secondary Filters ----- 5Nos
- 03. Silicon Washer Set ----- 1Set
- 04. Glass Tube ----- 1No.
- 05. Nozzle Cleaning Spring ----- 1No.
- 06. Single Nozzle ----- 1No.

Digital Rework Station 4 in one

Order Code - 72010



Soldering & De-Soldering Station

Specifications:

- Input Voltage : 190 V to 270V
- Output Voltage : 24V AC
- Soldering Wattage : 60 Watts
- De-Soldering Wattage : 70 Watts
- Temp range : 180-480°C
- Temp Accuracy : ± 1°C

- Tip to ground potential : Under 2MV
- Tip to ground Leakage : Under 2
- Vacuum : 600mm/Hg
- High Quality 24 DC Pump with 4000RPM
- SMT Tweezer : 2 x 25 watts
- SMD Hot Air
- Input Voltage : 220V AC
- Power Consumption : 300 Watts
- Air Pump : Diaphragm Type
- Capacity : 24 L/min
- Hot Air temperature : 200 to 550
- Temp Accuracy : ± 1°C
- Motor will switch off automatically after reaching 100°C when the element is switched off

Accessories :

- 01. Control Unit ----- 1 No.
- 02. Soldering Iron ----- 1 No.
- 03. De-Soldering Iron ----- 1 No.
- 4. Combined Soldering & De-Soldering Stand --- 1No.
- 05. SMD Hot Air Iron ----- 1No.
- 06. SMT Hot Tweezer Handle ----- 1No.
- 07. SMD Hot Air Stand ----- 1No.
- 08. Hot Tweezer Stand ----- 1No.
- 09. Power Cord ----- 1No.

Tool Box Containing

- 01. Primary Filter ----- 15 Nos
- 02. Secondary Filters ----- 5Nos
- 03. Silicon Washer Set ----- 1Set
- 04. Glass Tube ----- 1No.
- 05. Nozzle Cleaning Spring ----- 1No.
- 06. Single hole Nozzle ----- 1No.

The Complete Rework Station

Order Code - 72011



The Complete Rework Station

General Features:

- 01. Accurate and advanced temperature, control with micro controller technology
- 02. Set / Read of Operation
- 03. Separate of increase & decrease of temperature, after two seconds the actual read of Temperature will display
- 04. Intelligent power Management auto stand by mains interruption to save power
- 05. Temperature control accuracy ± 1°C
- 06. If sensor fails, power to the element shut off
- 07. The unit designed for digitally calibration thru advanced software
- 08. Burn Proof silicon cable thermal resistance up to 600°C
- 09. Power full DC Pump with 4000 RPM

Features:

- 01. Clear LCD Display
- 02. Nine Simultaneously Operations, all nine Ops Independent
- 03. Completely Indigenously developed
- 04. The Mini Lab Features in a tabletop Unit

System Includes:

01. Soldering Station : 24V / 60W
02. De-Soldering Stations : 24V / 70W
03. Thermal wire Stripper
04. DC Power Supplies : 1.5V to 18V DC
05. SMD Hot Air (with Built in Vacuum Pick Up)
06. SMT Hot Tweezer (2 x 25W)
07. Electric Screw driver

Soldering & De-Soldering Irons:

Input Voltage : 190 V to 27V
 Output Voltage : 24VAC
 Soldering element : 60 W
 De-Soldering element : 70W
 Temp range : 180-480 Deg.C
 Temp Accuracy : ± 1 deg.c
 Tip to ground Potential : Under 2MV
 Tip to Ground leakage : Under 2 E
 Vacuum : 600mm/Hg.
 High Quality 24 V DC Pump with 4000 RPM

SMD Hot Air

Input Voltage : 220VAC
 Power Consumption : 300 W
 Air Pump : Diaphragm Type
 Capacity : 24 L / min
 Hot Air Temperature : 200 to 550 Deg. C
 SMT Tweezer : 2 x 25 W
 Thermal Wire Stripper : 1.5V / 1Amps
 Quick heat Up : With in 2 Seconds
 Stepless increase of Temperature
 (Soft PVC to tough PTFE / Teflon)
 Electric screw driver
 Machine Centre
 DC power Supplies : 1.5V - 15V DC / 1Amps
 Auto Range Multimeter

Universal IC Tester

Order Code - 68001



It Can test gates, buffers and decoder ICs in-circuit. IC test clip is optionally provided with which the IC could be tested without removing from board. A maximum of six logic inputs could be driven and three logic outputs could be monitored in-circuit testing mode (F9) It is the latest Microcontroller based UNIVERSAL IC TESTER. It functionally tests a wide variety of Analog / Linear ICs including Microprocessor, Microcontrollers, EPROMs, Peripheral devices apart from 74 series of TTL ICs and 40/45 series of CMOS ICs.

Features:

01. No personality cards / reference IC / IC Data required.
02. ONE mode to test IC Once
03. CON Mode to test IC continuously
04. STEP mode to test step by step
05. Buzzer to indicate bad ICs
06. Reliable PC Keyboard to enter IC number and commands
07. Potential free 40 pin ZIF socket for easy insertion of IC under test
08. Protection against wrong insertion
09. Simple cable tester with learn facility.
10. Alphanumeric 40 x 2 backlit LCD for displaying messages
11. RS 232 serial interface expansion of IC Test Library
12. Built in self Test to test hardware, display, Keyboard and buzzer
13. Built in Word processor mode which converts system into an Electronic typewrite
14. Indigenously developed universal pin driver technology used
15. Help message through F1 key

One System Many Functions.

01. IC Tester
02. Word Processor
03. nC Development system
04. Simple Cable Tester

It has facility for expansion of test library through RS232C serial interface. If the data sheets of the new IC is furnished along with sample ICs, we could develop the testing program if the IC is testable. After downloading this test program in the tester, the new IC could be tested.

Technical Specifications:

- * Test Range Digital Analog/Linear ICs 6, 8, 14, 18, 20, 24, 28 & 40 Pin in dual in line (DIP) package
- * Socket 40 Pin Universal type ZIF (Zero Insertion Force)
- * Display 40 x 2 Backlit alphanumeric LCD display
- * Keyboard External IBM-PC PS/2 keyboard
- * Voltage 230V, AC 50Hz ± 10%
- * Enclosure Sheet Metal cabinet with powder coating and Engraving

Electronic Components Tester

Order Code - 68002



It is the latest Microcontroller based Electronic Components Functional Tester. It functionally tests a variety of electronic active components and linear ICs including Diodes, Zener Diode, Transistor, SCR, UJT, FET Operational Amplifiers, Comparators, Transistor Arrays, Optocouplers, Analog switches, Multiplexers, Voltage followers, A to D converters, D to A converters, Timers, VCO, PLL, Waveform Generators, Voltage Regulators, Seven Segment Displays, Relays & Other selected special function analog ICs.

- * No Personality cards/reference IC/IC data required.
- * Automatic testing of IC after entering the IC number. No wiring is required.
- * Continuous mode of testing ICs until aborted. Number of times the test was successful is displayed.
- * Step mode to locate the faulty pin. Step number and faulty pin number are displayed.
- * Backspace clear select option and number keys for editing IC number.
- * Remembers the IC number for repeated testing of same IC.
- * Self test facility during power-on and through keyboard.
- * Help key for short description of the various key function.
- * Potential free 20 pin ZIF (Zero Insertion Force) socket for easy insertion and removal of ICs under test and component holder to hold components.
- * Computer Interface through RS232C for enhancement of IC test library
- * Buzzer to indicate bad IC.

Digital IC Tester

Order Code - 68003



It is the latest MICROPROCESSOR based Digital IC Testers. It functionally tests a variety of digital ICs including Microprocessors, Peripheral ICs, EPROMs, RAMs, etc., apart from the standard 74 & 54 series of TTL ICs and 40 & 45 series of CMOS ICs.

Features:

01. No. personality cards / reference IC/IC data required.
02. Automatic testing of ICs at 4.75V & 5.25V to locate marginally bad ICs.
03. Continuous mode for testing ICs until Aborted. Number of times the test was successful if displayed.

04. Step mode to locate faulty pin through discrete LEDs for find the number of unknown good digital IC with facility to locate its functional equivalents for ICs upto 20 pins
05. Memory test for EPROM indicates non blank location address with data content. For RAMs bad location address is displayed.
06. Buzzer to indicate bad IC,
07. Separate field for display of mode of operation (ONE/CON/STP)
08. Current drawn is displayed in s separate field for Good ICs.
09. Backspace, clear and double digit entry keys for editing IC number
10. Remembers IC Numbers for repeated testing of same IC.
11. SELFTEST facility during power ON and through keyboard
12. Potential free 20 pin and 40 pin ZIF (zero insertion force)
13. Protection against wrong insertion of IC under test.

Linear IC Functional Tester (Microprocessor Based)

Order Code - 68004



It is the latest Microprocessor controlled linear IC Functional tester. It functionally test a variety of linear ICs including commonly used Operational amplifiers, Comparators, Transistor arrays, Optocouplers, Analog switches, Multiplexers, Voltage followers, Timers, A to D converters, D to A converters, cross point switches and other selected special function analog Ics.

Features:

01. No personality cards/reference IC/IC data required.
02. Automatic testing of IC after entering the IC number. No wiring is required.
03. Continuous mode of testing ICs until Aborted. Number of times the test was successful id displayed.
04. Buzzer to indicate bad IC
05. Separate field for display of mode of operation (One/Con/Stp).
06. Backspace, clear, select option and number keys for editing IC number.
07. Remembers the IC number for repeated testing of same IC
08. Self Test facility during Power ON and through keyboard
09. Help key for short description of the various key functions
10. Potential free 20 pin (ZIF Insertion Force) socket for easy insertion and removal of IC under test
11. Computer interface through RS232C for enhancement of IC test library

Technical Specifications:

Package Linear ICs and Analog & digital combined Ics of 6 , 8, 10, 14, 16, 18, 20, pins dual in line.
(Also round pack if inserted after

Range	bending leads to suit DIP) Operational Transistor arrays, Optocouplers, Analog switches, Multiplexers, Voltage Followers, Timers, A to D converters, D to A converters and other selected special function analog ICs,
Method	Output test with simulated inputs and at nominal loads. It performs only functional test and not parameter test.
Socket	20 pin DIP ZIF
Keyboard	24 feather touch keys
Display	16 character LCD dot matrix display
Voltage	230V ± 10% 50Hz AC
Enclosure	Sheet metal box with powder coating and screen printing

Analog & Digital IC Tester

Order Code - 68005



It is the latest MICROPROCESSOR based IC Tester. It functionally tests a wide variety of digital ICs upto 40 pins and Linear / Analog ICs upto 20pins

Display	: 16 x 2Backlit Alphanumeric LCD
Keyboard	: 24 keys keyboard
Package Digital IC	: Digital ICs 14, 16, 20, 24, 28 & 40 Pin DIP & Analog / Linear ICs 6, 8, 14, 16 & 20 Pin DIP
Range	: 74 Series of TTL ICs, 40 and 45 Series of CMOS ICs, Microprocessors (8085, 8086, 8088, Z80, 6502) Peripheral ICs (8255, 8253, 8251, 8259, 8155, 8279, Z80 PIO) EPROMs (blank check only) RAM ICs 6116,6264, 62256 etc.,
Analog IC Range	: Operational Amplifiers, Comparators, transistor arrays, optocouplers, Analog Switches, Multiplexers, Voltage followers, timers, cross point switches, ADC, DAC etc.,
Method	: Output test with simulated input and at nominal loads/Truth table comparison
Sockets	: 20 Pin ZIF for Linear and 40 Pin ZIF for Digital Ics
Voltage	: 230V 50Hz AC ± 10%
Enclosure	: Sheet Metal box with powder coating and Engraving

Specialized IC Programmer - Universal IC Programmer + IC Tester

Order Code - 68013



Hardware Features:

- * **Computer Interface**
 - USB port
- * **Universal Pin Drivers**
 - 40 Pin ZIF socket with universal 48pin-drivers., No. adapter required for DIP devices
 - Algorithms with machine architecture
 - Constructed around FPGA to achieve ultra-high programming speed.
- * **Super programming speed**
 - Programs 89C58 in less than 4 seconds.
- * **Over current & over voltage protection**
 - Added on each pin, to protect programmer hardware from destroying, due to bad chip, short circuit and ESD.
 - User-selectable verification.
 - Select verification voltage, e.g., Vcc, Vcc±5%, Vcc±10%, . This verification ensures that your device has been programmed properly, preventing failures due to programming errors and ensuring data retention.
 - Device insertion and contact checks
 - Performs device insertion and contact check before it programs each device & can detect poor pin contact & devices inserted upside down or in the wrong position. This function prevents chip from getting damaged due to operator error.
 - Remote Laptop Programming
 - No external AC adapter needed for most devices [for Devices having Vp < 12V]. Works on supply taken from USB port.
 - Universal PLCC, SOIC, SSOP.. to DIP adapters
 - No need to purchase a new adaptor for different devices of same package.
- * **Over 45 different adapters**
 - To support PLCC, SOIC, TQFP, TSSOP & other SMD devices.

Software features:

- * **Support Windows OS**
 - WIN98 SP2/NT/2000ME/XP/Vista OS.
- * **File Formats supported**
 - Binary, Intel Hex, Motorola S, Tektronix, formats and auto find format.
- * **Identifies the manufacturer and type of E(E)PROMs#**
 - Many EPROM and Flash memories have a build-in device ID and manufacturer ID. Programmer can read the device ID by selecting a checkbox, to detect the ID and compare its database to determine the chip's correct vendor and product number. This feature is especially useful with second hand chips and devices that have had their part number accidentally (or intentionally) removed (function only applies to 28/32 pin EPROM and Flash memories only.
- * **User-friendly interfaces**
 - With pull-down menus, pop-up dialogue box and help.
- * **OTP-security for AT89C5X.**
 - Function available for AT89C51/32. Applying this function will disable re-programming.
- * **Mass Production mode**
 - Programmer automatically detects & programs device, you don't need to press any accidental mistakes. For Quantity Production, user can connect 4 programmers to a single computer.

Quantum users who would like know more about this feature please contact our Customer Support Engineer.

- * **Project file save and load**
 - User can create and save a project file which contains device selection, buffer data and all the programming set-up options. This project file can be called upon at any time for future use, without having to go through the setting up procedure again. Your design file can easily be sent to production department without any operator error.
- * **Make your own SMD Adapter**
 - If you wish to build a adapter on your own, UNIP ro Software provides SMD adapter pin swapping tables.
- * **Support all operations**
 - such as read, blank check, erase, program, secure, verify and so on.
- * **Set addresses intelligently**
 - Device start address, device and address, from buffer address and so on.
- * **Integrated editors**
 - To modify HEX files, JEDEC files with commands-fill, copy, move, swap, etc.
- * **supports most of the compilers for PLD'S in JEDC, format**
 - ABEL, CUPL, PALASM, OrCAD PLD, PLD Designer and ISDATA
- * **Adjustable IC parameters**
 - Adjustable programming algorithms such as Vpp voltage, and impulse width. N.B - To be used by an experienced user only.p,etc.
- * **Serialization parameters**
 - If your devices need individual serial numbers with different increment sequence and initial value, the programmer simply increments the serial numbers in the buffer each time a new device is inserted.
- * **Digital IC Tester**
 - Tests TTL 74 xxx 54/74 (LS/HC/HCT/ALS/S/AS/F/..) xxx series. Tests 40XX, 45XX CMOS IC's. You can add a new device by entering test vector tables of the new device is inserted.
- * **Auto Find Device**
 - Conducts exhaustive functional tests & finds out of the number of an unknown device (TTL & CMOS).
- * **Add on's**
 - Built in 8-channel, logic analyzer, Frequency generator 125Khz, & Frequency meter upto 100KHz.

Specifications:

- * Programmer dimensions : 110mm L x 165mm W x 20mm H
- * Power supply : Input : AC 100 to 240V Output : 9V/1A.
- * Weight : 265gms

Specialized IC Programmer for PIC MCU's / 12C EEPROM's

Order Code - 68026



The 68026 Programmer is an affordable, reliable, and fast production grade programmer for OTP Micro controllers and 24Cxx 12C EEPROM's*.

Hardware Features:

01. Single 40 Pin ZIF for 8 to 40 Pin Devices.
02. RS232 Serial Port Interface.
03. Programmer firmware update through computer.
04. Programmer hardware verifies IC's at 3 different voltage levels after programming for improved reliability.
05. ISP programming supported.

Software Features:

01. Automatic device identification before programming.
02. Supports all operations program, verify, blank check, read, secure, erase & so on.
03. Auto Batch Program function for faster programming i.e. Mass Production mode.
04. User-friendly interfaces with pull-down menus, pop-up dialogue box and help.
05. Works on all windows platform 95/98/2000/XP.
06. Supports Intel (linear & segmented) HEX (INHX8M).
07. Auto execution of multiple functions.
08. Easy to use integrated HEX Editor on main software window.
09. Device insertion test.
10. Support for programming only a selected memory in the microcontroller e.g. Code memory, Data memory or configuration memory.

Devices Supported:

12F508	12F509	12F629	12F675	16F630
16F676	16C83	16C84	16F627	16F627A
16F628	16F628A	16F648A	16F83	1 6 F 8 4
16F84A	16LF627	16LF628	16LF648A	18F1220
18F1320	16F72	16F73	16F737	1 6 F 7 6
16F767	16F870	16F872	16F873	16F873A
16F876	16F876A	18F242	18F248	18F252
18F258	18F2220	18F2320	18F2439	18F2539
16F74	16F747	16F77	16F777	16F871
16F874	16F874A	16F877	16F877A	18F442
18F448	18F452	18F458	18F4220	18F4320
18F4439	18F4539			
12C508	12C508A	12C509	12C509A	16C505
16C61	16C620	16C620A	16C621	16C621A
16C622	16C622A	16C71	16C71A	16C710
16C71 1	16C712	16C716	16CE623	16CE624
1 6CE625	16CR83	16CR84	16C62	16C62A
16C62B	16C63	16C63A	16C66	16C66A
16C72	16C72A	16C73	16C73A	16C73B
16C745	16C76	16C773	16C64	16C64A
16C65	16C65A	16C65B	16C67	1 6 C 7 4
16C74A	16C74B	16C765	16C77	16C77A

Serial Eeprom's

24C01	24C01A	AT24C01A	24C02	AT24C02
24C04	24C04A	24C08	2 4 C 1 6	2 4 C 3 2
24C64	24C128	24C256	24C512	

Specifications:

- * Programmer Dimensions : 105mm L x130mm W x 25mm H
- * Power Supply : Input AC 100 to 240V, Output: DC16V/600mA.
- * Weight : 375 gms

Programmer Package Contents System Requirements

Standard Package Contains The Following :

01. A programmer
02. Serial cable, 10 Pin FRC F-F cable for ISP
03. An AC adapter
04. Installation software CD

The minimum requirements are as follows:

01. A PC, IBM or compatible, desktop or laptop, with one Serial port.
02. Win Xp
03. CD-ROM driver
04. Hard disk of at least 1 00MB of spare capacity

Digital IC Tester

Order Code - 68027



Features:

Device Supports

01. Tests a wide range of Digital IC's such as 74 Series, 40/45 Series of CMOS IC's
02. It has Auto search facility of IC's
03. Test by: Truth table/sequence table comparison.
04. ZIF: 28 pin DIP ZIF sockets.
05. Keys: 16 keys Key pad with numerical & functional keys.
06. Display: 16x2 LCD Display.
07. Supply Input Voltage:9V DC Adaptor.

T.T.L. 74XXX series

4000	4001	4002	4006	4007	4008	4009	4010	4011
4012	4013	4014	4015	4016	4017	4018	4019	4021
4022	4023	4024	4025	4026	4027	4028	4029	4030
4031	4032	4033	4034	4035	4038	4040	4041	4042
4043	4044	4048	4049	4050	4051	4052	4053	4055
4056	4060	4063	4066	4067	4068	4069	4070	4071
4072	4073	4075	4076	4077	4078	4081	4082	4085
4086	4093	4094	4095	4096	4097	4099	40101	40106
40109	40147	40160	40161	40162	40163	40174	40175	40192
40193								

7400	7401	7402	7403	7404	7405	7406	7407	7408
7409	7410	7411	7412	7413	7414	7415	7416	7417
7418	7419	7420	7421					

7422	7423	7424	7425	7426	7427	7428	7430	7431
7432	7433	7434	7435	7437	7438	7439	7440	7442
7443	7444	7445	7446	7447	7448	7449	7450	7451

7452 7453 7454 7455 7456 7457 7458 7460 7461
 7462 7463 7464 7465 7473 7474 7475 7476 7485
 7486 7492 7493 7495 74107 74109 74112 74113
 74114 74123 74125 74126 74128 74131 74132 74133
 74134 74135 74136 74137 74138 74139 74140 74141
 74145 74147 74148 74149 74150 74151 74152 74153
 74154 74155 74156 74157 74158 74160 74161 74162
 74163 74164 74165 74166 74168 74170 74173 74174
 74175 74180 74181 74182 74183 74190 74191 74192
 74193 74194 74195 74237 74240 74241 74242 74243
 74244 74245 74246 74247 74248 74249 74251 74252
 74253 74257 74258 74259 74260 74265 74266 74273
 74278 74279 74280 74283 74290 74292 74293 74294
 74295 74298 74299 74323 74348 74351 74352 74353
 74354 74356 74363 74364 74365 74366 74367 74368
 74373 74374 74375 74377 74378 74386 74390 74393
 74399 74425 74426 74465 74466 74467 74468 74490
 74518 74519 74520 74521 74522 74533 74534 74540
 74541 74563 74564 74573 74574 74575 74576 74577
 74580 74589 74595 74597 74620 74621 74622 74623
 74638 74639 74640 74641 74642 74643 74644 74645
 74646 74670 74688 74689 74LS51 74LS54

4501 4502 4503 4504 4506 4508 4510 4511 4512
 4514 4515 4518 4519 4520 4529 4532 4538 4543
 4553 4555 4556 4572 4584 4585

Universal IC Tester

Order Code - 68028



Features:

Device Supports

01. Tests a wide range of Digital IC's such as 74 Series, 40/45 Series of CMOS Ic's
02. It can test Microprocessor 8085, 8086, Z80
03. It tests Peripherals like 8255, 8279, 8253, 8259, 8251, 8155, 6264, 62256, 8288, 8284
04. It tests Opamp, 555, Transistor Arrays, Analog switches, Opto couplers and Others
05. It tests Seven segment display of common cathode & common anode type
06. It has Auto search facility of Ic's
07. Test by: Truth table/sequence table comparison.
08. ZIF: 40 pin DIP ZIF sockets.
09. Keys: 28 Touch-keys Key pad with numerical & functional keys
10. Display: 9 Digit Seven Segment Display.
11. Supply Input Voltage: 230VAC.

T.T.L. 74XXX series

7400 7401 7402 7403 7404 7405 7406 7407 7408
 7409 7410 7411 7412 7413 7414 7415 7416 7417
 7418 7419 7420 7421 7422 7423 7424 7425 7426
 7427 7428 7430 7432 7433 7437 7438 7439 7440
 7442 7443 7444 7445 7446 7447 7448 7449 7450
 7451 7453 7454 7462 7464 7465 7470 7471 7472
 7473 7474 7475 7476 7478 7483 7485 7486 7489
 7490 7491 7492 7493 7495 7496 7497 74107 74109
 74112 74113 74114 74116 74121 74122 74123 74125
 74126 74128 74132 74133 74134 74135 74136 74137
 74138 74139 74140 74141 74145 74147 74148 74150

74151 74152 74153 74154 74155 74156 74157 74158
 74159 74160 74161 74162 74163 74164 74165 74166
 74168 74169 74170 74172 74173 74174 74175 74176
 74177 74180 74181 74182 74183 74184 74185 74189
 74190 74191 74192 74193 74194 74195 74196 74197
 74198 74200 74221 74238 74240 74241 74242 74243
 74244 74245 74246 74247 74248 74249 74251 74253
 74256 74257 74258 74259 74260 74266 74273 74279
 74280 74283 74290 74293 74298 74299 74322 74340
 74341 74344 74347 74348 74350 74351 74352 74353
 74354 74365 74366 74367 74368 74373 74374 74375
 74377 74378 74379 74381 74382 74386 74390 74393
 74395 74398 74399 74412 74423 74425 74426 74445
 74447 74490 74521 74534 74540 74541 74590 74591
 74595 74543 74544 74563 74564 74573 74574 74575
 74577 74580 74589 74596 74620 74621 74622 74623
 74638 74639 74640 74641 74642 74643 74645 74646
 74647 74648 74649 74652 74657 74668 74669 74670
 74688 74689 74786 74800 74802 74804 74805 74808
 74832 74841 74874 74901 74902 74903 74904 74906
 74C923 74C925 74C926 74C927 74C928 74C929
 74989 41244 741245 741623 741621 741639 741640
 741641 741642 741643 741644 741645 743037
 743038 74H01 74LS51 74H54 74L54 74L71 74H71
 74LS73 74LS76 74LS78 74L85 74L86 74C89 74L93
 74L95 74LS107 8280 8281 8290 8291

CMOS (CD 4XXX SERIES)

4000 4001 4002 4006 4007 4008 4009 4010 4011
 4012 4013 4014 4015 4017 4018 4019 4020 4021
 4022 4023 4024 4025 4026 4027 4028 4029 4030
 4031 4032 4033 4034 4035 4038 4040 4041 4042
 4043 4044 4046 4047 4048 4049 4050 4051 4052
 4053 4054 4055 4056 4060 4063 4066 4067 4068
 4069 4070 4071 4072 4073 4075 4076 4077 4078
 4081 4082 4085 4086 4093 4094 4095 4096 4098
 4099 40105 40106 40107 40109 40147 40160 40161
 40162 40163 40174 40175 40181 40182 40192 40193
 40194 40195 40244 40245 40257 40373 40374 40097
 40098 4490 4502 4503 4504 4506 4507 4508 4510
 4511 4512 4514 4515 4516 4518 4519 4520 4522
 4526 4527 4528 4531 4532 4534 4538 4539 4541
 4543 4544 4555 4556 4558 4562 4566 4572 4584
 4585 4599 4723 4724 4727

MEMORIES

2102 2114 2115 2125 2147 2148 2149 6116 6264
 62256 621024 9101 91L22 93412 93422 93425 41256
 4256 50256

NV RAMS

1220 1225 1230 1235 1240 1245 2210 2212

CPU

8085 8086 V20 8088 8400(Z80) 6502 65C02 65SC02

PERIPHERALS

8155 8156 8205 8212 8216 8226 8237 8251 8253
 8254 8255 8257 8259 8279 8282 8283 8284 8286
 8287 8288 8250 82450 6350 6820 6821 6822 6840
 6844 6845 6850 6851 6852 6854 6520 6521 6522
 6524 6551 65C51 8420(Z80PIO) 8430 (Z80CTC)
 8440(SIO-0) 8441 (SIO-1) 8442 (SIO-2) 8449 (SIO-
 90) 1852 1871 1879 2681

TRANSISTOR ARRAYS ULN

2001 2003 2004 2005 2011 2013 2014 2015 2021
 2023 2024 2025 2064 2065 2066 2067 2801 2803

2804 2805 2811 2813 2814 2815 2821 2823 2824
2825

RCA

3083 3086 75468 75491 75492

LATCH/DRIVERS

UCN4801 UCN5801

LINE DRIVERS & RECEIVERS

26LS31 26LS32 743037 743038 75174 75175 75176
75182 75183 75450 75451 75452 75453 75454 8820
8830 96174 96175

LINEAR ICs

124 224 324 339 358 386 393

ANALOG SWITCHES

DG200 DG201 DG202 DG211 DG212 DG509 4016
4051 4052 4053 4066

TIMERS

555 556

CROSSPOINT SWITCHES

22100 42100 45100 22101

REAL TIME CLOCKS

1879 5832 58167 82C8167 Ds1287

PHASE FREQUENCY DETECTORS

MC4044 Mc4344

DECODER/ENCODER

1441 1442

SUPERVISORY CIRCUITRY Dallas

1231 1232 MX690 Mx691

7 SEGMENT DISPLAYS

LT312 LT542 Lt543 5082 Hp5501

OSCILLATOR / DIVIDER

5369

Universal IC Tester

Order Code - 68029



Features:

Digital IC's

01. Tests a wide range of Digital IC's such as 74 Series, 40/45 Series of CMOS IC's.
02. It can test Microprocessor 8085, 8086, Z80.
03. It tests Peripherals like 8255, 8279, 8253, 8259, 8251, 8155, 6264, 62256, 8288, 8284.
04. It tests a wide range of Analog IC's such as ADC, DAC, Opamp, 555, Transistor Arrays, Analog Switches, Waveform Generator, Line Drivers, Voltages Regulators, PLL's, VCO, PWM Generator, Sample & Hold, Voltages References, Opto couplers, Comparators, Voltages Followers and Others.
05. It tests Seven segment display of common cathode & common anode type

06. It has Auto search facility for Digital IC's.
07. Test by: Truth table/sequence table comparison.
08. ZIF: Two Nos. of 40 pin DIP ZIF sockets for Digital & Analog IC's.
09. Keys: 50 cherry keys Key pad with numerical & functional keys.
10. Display: 16x2 Backlit LCD Display
11. Supply Input Voltage: 230VAC.

Device Supports

T.T.L. 74XXX series

7400 7401 7402 7403 7404 7405 7406 7407 7408
7409 7410 7411 7412 7413 7414 7415 7416 7417
7418 7419 7420 7421 7422 7423 7424 7425 7426
7427 7428 7430 7432 7433 7437 7438 7439 7440
7442 7443 7444 7445 7446 7447 7448 7449 7450 7451
7453 7454 7462 7464 7465 7470 7471 7472 7473
7474 7475 7476 7478 7483 7485 7486 7489 7490
7491 7492 7493 7495 7496 7497 74107 74109 74112
74113 74114 74116 74121 74122 74123 74125 74126
74128 74132 74133 74134 74135 74136 74137 74138
74139 74140 74141 74145 74147 74148 74150 74151
74152 74153 74154 74155 74156 74157 74158 74159
74160 74161 74162 74163 74164 74165 74166 74168
74169 74170 74172 74173 74174 74175 74176 74177
74180 74181 74182 74183 74184 74185 74189 74190
74191 74192 74193 74194 74195 74196 74197 74198
74221 74238 74240 74241 74242 74243 74244 74245
74246 74247 74248 74249 74251 74253 74256 74257
74258 74259 74260 74266 74273 74279 74280 74283
74290 74293 74298 74299 74322 74340 74341 74344
74347 74348 74350 74351 74352 74353 74354 74365
74366 74367 74368 74373 74374 74375 74377 74378
74379 74381 74382 74386 74390 74393 74395 74398
74399 74412 74423 74425 74426 74445 74447 74490
74521 74534 74540 74541 74543 74544 74563 74564
74573 74574 74575 74577 74580 74589 74590 74591
74595 74596 74620 74621 74622 74623 74638 74639
74640 74641 74642 74643 74645 74646 74647 74648
74649 74652 74668 74669 74670 74688 74689 74786
74800 74802 74804 74805 74808 74832 74841 74874
74901 74902 74903 74904 74906 74C923 74C925
74C926 74C927 74C928 74C929 74989 741244
741245 741623 741621 741639 741640 741641
741642 741643 741644 741645 743037 743038
74H01 74LS51 74H54 74L54 74L71 74H71 74LS73
74LS76 74LS78 74L85 74L86 74C89 74L93 74L95
74LS107 8280 8281 8290 8291

CMOS (40/45 XX SERIES)

4000 4001 4002 4006 4007 4008 4009 4010 4011
4012 4013 4014 4015 4017 4018 4019 4020 4021
4022 4023 4024 4025 4026 4027 4028 4029 4030
4031 4032 4033 4034 4035 4038 4040 4041 4042
4043 4044 4047 4048 4049 4050 4054 4055 4056
4060 4063 4067 4068 4069 4070 4071 4072 4073
4075 4076 4077 4078 4081 4082 4085 4086 4093
4094 4095 4096 4098 4099 40105 40106 40107 40109
40147 40160 40161 40162 40163 40174 40175 40181
40182 40192 40193 40194 40195 40244 40245 40257
40373 40374 40097 40098 4490 4502 4503 4504 4506
4507 4508 4510 4511 4512 4514 4515 4516 4518 4519
4520 4522 4526 4527 4528 4531 4532 4534 4538
4539 4541 4543 4544 4555 4556 4558 4562 4566
4572 4584 4585 4599 4723 4724 4727 4801 5801

CPU

8085 8086 V20 8088 8400(Z80) 6502 65C02 65SC02
8035 8039 8748 8749

PERIPHERAL

8155 8156 8205 8212 8216 8226 8237 8251 8253
 8254 8255 8257 8259 8279 8282 8283 8284 8286
 8287 8288 8250 82450 6350 6820 6821 6822 6840
 6844 6845 6850 6851 6852 6854 6520 6521 6522
 6524 6551 65C51 8420(Z80-PIO) 8430(Z80-CTC)
 8440 (SIO-0) 8441 (SIO-1) 8442 (SIO-2) 8449 (SIO-
 90) 1852 1871 1879 2681

MEMORY

2102 2114 2115 2125 2149 6116 6264 62256 621024
 9101 91L22 93412 93422 93425 4256 41256 5025

REAL TIME CLOCK

1879 5832 58167 82C8167 Ds1287

PHASE FREQUENCY DETECTOR

MC4044 Mc4344

DECODER/ENCODER

1441 1442

SUPERVISORY CIRCUITRY

Dallas 1231 1232

SEVEN SEGMENT DISPLAY

LT542 LT543

OSCILLATOR / DIVIDER

5369

LINEAR IC'S

ANALOG TO DIGITAL CONVERTER

ADC0800 ADC0801 ADC0802 ADC0803 ADC0804
 ADC0805 ADC0808 ADC0816 ADC0817 AD574 7109
 3162 ADC0809

DIGITAL TO ANALOG CONVERTER

DAC08 DAC0800 DAC0801 DAC0802 DAC0808
 DAC1408 DAC1508 DAC558 DAC1020 DAC1021
 DAC1022 DAC1220 DAC1221 DAC1222 DAC7520
 DAC7521 DAC7523 DAC7524 DAC7530 DAC7531
 DAC7533 DAC7541

COMPARATOR

106 111 160 193 211 260 293 311360 393 2903 17393
 Ca3290 111 119 139 161 211 219 239 261 311 319 339
 361 2901 3302 17339 521 522 527 529 2111 2211
 2311

OP-AMP

AD548 AD648 AD707 AD708 AD711 AD712 AD744
 Ad746 AD821 AD845 AD846 AD847 AD848 AD849
 CA081 Ca082 CA307 CA3100 CA3130 CA3140 CA3193
 Ca3240 CA3160CA3260 LF 351 353 386 412 442 LM 10
 11 101 107 108 112 118 143 155 156 157 158 201 207
 208 212 218 255 256 257 258 301 307 308 312 318
 343 355 356 357 358 411 441 530 531 532 538 714
 725 741 748 1458 1558 2904 3080 33181 4250 4558
 5204 5205 5230 5512 5532 5534 5535 13741 17301
 17741 17458 17558 OP05 OP07 OP21 OP27 OP37
 OPA121 OPA602 OPA606 OPA11 TL061 TL062 TL071
 TL072 TL081 TI082 LT1013 709 1709 7611 7612 7621
 AD713 AD840 AD841 AD842CA084 LM 11 101 107 108
 112 118 124 147 148 149 201 207 208 212 218 224
 248 249 301 307 308 312 318 324 347 348 349 442
 444 534 725 741 747 748 2900 2902 3303 3403 3503

5514 17301 17741 TL064 TL074 TL084 OPA404 7641
 7642 LT1014524 5533

VOLTA GE FOLLOWER

110 210 310 102 110 202 210 302 310

LINE DRIVERS & RECEIVER

1488 1489 3486 3487 75107 75108 75110 75114
 75121 75174 75175 75176 75182 75183 75188 75189
 75450 75451 7545275453 75454 75477 75491 75492
 75494 7820 7830 7831 7832 8820 8830 8831 8832
 26LS31 26LS32 96174 96175 145406 10125

TRANSISTOR ARRAY

394 CA3028 CA3046 CA3053 CA3054 Ca3146
 CA3083CA3086 ULN2001 ULN2003 ULN2004 ULN2005
 ULN2015 ULN2011 ULN2013 ULN2014 ULN2021
 ULN2023 ULN2024 ULN2069 ULN2025 ULN2064
 ULN2065 ULN2068 ULN2801 ULN2803 ULN2815
 ULN2804 ULN2805 ULN2811 ULN2813 ULN2814
 ULN2821 54566 ULN2823 ULN2824 ULN2825 L601
 L603 L604

ANALOG SWITCH

4016 4051 4052 4053 4066 6108 6208 11201 11202
 11331 11508 11509 13201 13202 13331 11332 13332
 13508 13509 14016 14051 14052 14053 14066 DG200
 DG201 DG202DG308 DG309 DG211 DG212 DG506
 DG507 DG508 Dg509

WAVEFORM GENERATOR

8038

TIMER

555 556 7555

PLL

565 567N 4046

VCO

131 231 331 131A 231A 331A 4151 566N

SAMPLE AND HOLD

198 298 398 5537

PWM GENERATOR

1524 2524 3524 494 594 3525

DPM IC

7106 7107 7116 7117 7126 7136 7137

OPTO-COUPLER

4N25 4N26 4N27 4N28 4N32 4N33 4N35 4N36 4N37
 4N38 6N135 6N136 6N137 6N138 6N139 6N140
 CNY171 CNY172 CNY173 H11A1 H11C1 H11C4 H11D1
 H11D2 H11G1 H11G2 MCT2 MCT2E MCT6 MCT26
 MCT210 MCA230 MCA231 MCA255 MOC3006
 MOC3010 MOC3020 MOC3021 MOC3022 MOC3023
 MOC3030 MOC3040 MOC3041 MOC3061 MOC3063
 TIL111 TIL112 TIL113 TIL114 TIL115 TIL116 TIL117
 TIL118 TIL119 TIL126 TIL155 HCPL 2531 26312731
 2502 2602 2601 2630 3700 SFH600_0 SFH600_3
 SFH610_1 SFH610_2 SFH611_1 SL5500 SI5501
 PC817PS2041 2501 EECF CROSS POINT SWITCH
 22100 22101 42100 45100

LATCH DRIVER

UCN4801 UCN5801

VOLTAGE REGULATOR

7805 78L05 78M05 78T05 7806 7808 7812 7815 7824
7905 79L05 79M05 7906 7908 7915 7918 117 117L
117M 217 217L 217M 317 317L 317M 337 18512 28512
38512 18525 28525 38525 2930 2931 723

VOLTAGE REFERENCE

185_1.2 185_2.5 285_1.2 285_2.5 385_1.2 385_2.5
DOT/BAR Display Driver 3914 3915

OPAMP AND COMPARATOR

192 292 392 2924

OVER VOLTAGE CROWBAR SENSING CIRCUIT

3423 3523

LED FLASHER

3909

FREQUENCY TO VOLTAGE CONVERTER

2907 2917

WAVEFORM GENERATOR

8038

TIMER

555 556 7555

PLL

565 567N 4046

VCO

131 231 331 131A 231A 331A 4151 566N

SAMPLE AND HOLD

198 298 398 5537

Linear IC Tester

Order Code - 68030



Features

Device Supports

01. Tests a wide range of Analog Ic's such as ADC, DAC, Opamp, 555, Transistor Arrays, Analog Switches, Waveform Generator, Line Drivers, Voltages Regulators, PLL's, VCO, PWM Generator, Sample & Hold, Voltages References, Opto couplers, Comparators, Voltages Followers and Others. Test by : Truth table/sequence table comparison.
02. ZIF: 40 pin DIP ZIF sockets.
03. Keys: 50 cherry keys Key pad with numerical & functional keys.
04. Display: 16x2 Backlit LCD Display
05. Supply Input Voltage: 230VAC.

LINEAR IC'S

ANALOG TO DIGITAL CONVERTER

ADC0800 ADC0801 ADC0802 ADC0803 ADC0804
ADC0805 ADC0808 ADC0816 ADC0817 AD574 7109
3162 ADC0809

DIGITAL TO ANALOG CONVERTER

DAC08 DAC0800 DAC0801 DAC0802 DAC0808
DAC1408 DAC1508 DAC558 DAC1020 DAC1021
DAC1022 DAC1220 DAC1221 DAC1222 DAC7520
DAC7521 DAC7523 DAC7524 DAC7530 DAC7531
DAC7533 DAC7541

COMPARATOR

106 111 160 193 211 260 293 311360 393 2903 17393
CA3290 111 119 139 161 211 219 239 261 311 319
339 361 2901 3302 17339 521 522 527 529 2111 2211
2311

OP-AMP

AD548 AD648 AD707 AD708 AD711 AD712 AD744
AD746 Ad821 AD845 AD846 AD847 AD848 AD849
CA081 CA082 CA307 Ca3100 CA3130 CA3140 CA3193
CA3240 CA3160 CA3260 LF 351 353 386 412 442 LM 10
11 101 107 108 112 118 143 155 156 157 158 201 207
208 212218 255 256 257 258 301 307 308 312 318 343
355 356 357 358 411 441 530 531 532 538 714 725
741 748 1458 1558 2904 3080 33181 4250 4558 5204
5205 5230 5512 5532 5534 5535 13741 17301 17741
17458 17558 OP05 OP07 OP21 OP27 OP37 OPA121
OPA602 OPA606 OPA11 TL061 TL062 TL071 TL072
TL081 TL082 LT1013 709 1709 7611 7612 7621 AD713
AD840 AD841 AD842 CA084 LM 11 101 107 108 112
118 124 147 148 149 201 207 208 212 218 224 248
249 301 307 308 312 318 324 347 348 349 442 444
534 725 741 747 748 2900 2902 3303 3403 3503 5514
17301 17741 TL064 TL074 TL084 OPA404 7641 7642
LT1014 524 5533

VOLTAGE FOLLOWER

110 210 310 102 110 202 210 302 310

LINE DRIVERS & RECEIVER

1488 1489 3486 3487 75107 75108 75110 75114
75121 75174 75175 75176 75182 75183 75188 75189
75450 75451 75452 75453 75454 75477 75491 75492
75494 7820 7830 7831 7832 8820 8830 8831 8832
26LS31 26LS32 96174 96175 145406 10125

TRANSISTOR ARRAY

394 CA3028 CA3046 CA3053 CA3054 CA3146 CA3083
Ca3086 ULN2001 ULN2003 ULN2004 ULN2005
ULN2015 ULN2011 ULN2013 ULN2014 ULN2021
ULN2023 ULN2024 ULN2069 ULN2025 ULN2064
ULN2065 ULN2068 ULN2801 ULN2803 ULN2815
ULN2804 ULN2805 ULN2811 ULN2813 ULN2814
ULN2821 54566 ULN2823 ULN2824 ULN2825 L601
L603 L604

ANALOG SWITCH

4016 4051 4052 4053 4066 6108 6208 11201 11202
11331 11508 11509 13201 13202 13331 11332 13332
13508 13509 14016 14051 14052 14053 14066 DG200
DG201 DG202 DG308 DG309 DG211 DG212 DG506
DG507 DG508 DG509

WAVEFORM GENERATOR

8038

TIMER

PLL

565 567N 4046

VCO

131 231 331 131A 231A 331A 4151 566N

SAMPLE AND HOLD

198 298 398 5537

PWM GENERATOR

1524 2524 3524 494 594 3525

DPM IC

7106 7107 7116 7117 7126 7136 7137

OPTO-COUPLER

4N25 4N26 4N27 4N28 4N32 4N33 4N35 4N36 4N37
 4N38 6N135 6N136 6N137 6N138 6N139 6N140
 CNY171 CNY172 CNY173 H11A1 H11C1 H11C4 H11D1
 H11D2 H11G1 H11G2 MCT2 MCT2E MCT6 MCT26
 MCT210 MCA230 MCA231 MCA255 MOC3006
 MOC3010 MOC3020 MOC3021 MOC3022 MOC3023
 MOC3030 MOC3040 MOC3041 MOC3061 MOC3063
 TIL111 TIL112 TIL113 TIL114 TIL115 TIL116 TIL117
 TIL118 TIL119 TIL126 TIL155 HCPL 2531 2631
 27312502 2602 2601 2630 3700 SFH600_0 SFH600_3
 SFH610_1 SFH610_2 SFH611_1 SL5500 SL5501
 PC817 PS2041 2501 EECF

CROSS POINT SWITCH

22100 22101 42100 45100

LATCH DRIVER

UCN4801 UCN5801

VOLTAGE REGULATOR

7805 78L05 78M05 78T05 7806 7808 7812 7815 7824
 7905 79L05 79M05 7906 7908 7915 7918 117 117L
 117M 217 217L 217M 317 317L 317M 337 18512 28512
 38512 18525 28525 38525 2930 2931 723

VOLTAGE REFERENCE

185_1.2 185_2.5 285_1.2 285_2.5 385_1.2 385_2.5
 DOT/BAR Display Driver 3914 3915

OPAMP AND COMPARATOR

192 292 392 2924

OVER VOLTAGE CROWBAR SENSING CIRCUIT

3423 3523

LED FLASHER

3909

FREQUENCY TO VOLTAGE CONVERTER

2907 2917.

Digital IC Tester

Order Code - 68031



Features

01. Tests a wide range of Digital IC's such as 74 Series, 40/45 Series of CMOS IC's.

02. It can test Microprocessor 8085, 8086, Z80.

03. It tests Peripherals like 8255, 8279, 8253, 8259, 8251, 8155, 6264, 62256, 8288, 8284.

04. It tests Seven segment display of common cathode & common anode type.

05. It has Auto search facility of Ic's.

06. Test by: Truth table/sequence table comparison.

07. ZIF: 40 pin DIP ZIF sockets.

08. Keys: 28 Touch-keys Key pad with numerical & functional keys.

09. Display: 9 Digit Seven Segment Display.

10. Supply Input Voltage: 230VAC.

Device Supports

T.T.L. 74XXX series

7400 7401 7402 7403 7404 7405 7406 7407 7408
 7409 7410 7411 7412 7413 7414 7415 7416 7417
 7418 7419 7420 7421 7422 7423 7424 7425 7426
 7427 7428 7430 7432 7433 7437 7438 7439 7440
 7442 7443 7444 7445 7446 7447 7448 7449 7450
 7451 7453 7454 7462 7464 7465 7470 7471 7472
 7473 7474 7475 7476 7478 7483 7485 7486 7489
 7490 7491 7492 7493 7495 7496 7497 74107 74109
 74112 74113 74114 74116 74121 74122 74123 74125
 74126 74128 74132 74133 74134 74135 74136 74137
 74138 74139 74140 74141 74145 74147 74148 74150
 74151 74152 74153 74154 74155 74156 74157 74158
 74159 74160 74161 74162 74163 74164 74165 74166
 74168 74169 74170 74172 74173 74174 74175 74176
 74177 74180 74181 74182 74183 74184 74185 74189
 74190 74191 74192 74193 74194 74195 74196 74197
 74198 74200 74221 74238 74240 74241 74242 74243
 74244 74245 74246 74247 74248 74249 74251 74253
 74256 74257 74258 74259 74260 74266 74273 74279
 74280 74283 74290 74293 74298 74299 74322 74340
 74341 74344 74347 74348 74350 74351 74352 74353
 74354 74365 74366 74367 74368 74373 74374 74375
 74377 74378 74379 74381 74382 74386 74390 74393
 74395 74398 74399 74412 74423 74425 74426 74445
 74447 74490 74521 74534 74540 74541 74590 74591
 74595 74543 74544 74563 74564 74573 74574 74575
 74577 74580 74589 74596 74620 74621 74622 74623
 74638 74639 74640 74641 74642 74643 74645 74646
 74647 74648 74649 74652 74657 74668 74669 74670
 74688 74689 74786 74800 74802 74804 74805 74808
 74832 74841 74874 74901 74902 74903 74904 74906
 74C923 74C925 74C926 74C927 74C928 74C929
 74989 741244 741245 741623 741621 741639
 741640 741641 741642 741643 741644 741645
 743037 743038 74H01 74LS51 74H54 74L54 74L71
 74H71 74LS73 74LS76 74LS78 74L85 74L86 74C89
 74L93 74L95 74LS107 8280 8281 8290 8291

CMOS (CD 4XXX SERIES)

4000 4001 4002 4006 4007 4008 4009 4010 4011
 4012 4013 4014 4015 4017 4018 4019 4020 4021
 4022 4023 4024 4025 4026 4027 4028 4029 4030 4031
 4032 4033 4034 4035 4038 4040 4041 4042 4043
 4044 4046 4047 4048 4049 4050 4051 4052 4053
 4054 4055 4056 4060 4063 4066 4067 4068 4069
 4070 4071 4072 4073 4075 4076 4077 4078 4081
 4082 4085 4086 4093 4094 4095 4096 4098 4099
 40105 40106 40107 40109 40147 40160 40161 40162
 40163 40174 40175 40181 40182 40192 40193 40194
 40195 40244 40245 40257 40373 40374 40097 40098
 4490 4502 4503 4504 4506 4507 4508 4510 4511
 4512 4514 4515 4516 4518 4519 4520 4522 4526
 4527 4528 4531 4532 4534 4538 4539 4541 4543

4544 4555 4556 4558 4562 4566 4572 4584 4585
4599 4723 4724 4727

MEMORIES

2102 2114 2115 2125 2147 2148 2149 6116 6264
62256 621024 9101 91L22 93412 93422 93425 41256
4256 50256

NV RAMS

1220 1225 1230 1235 1240 1245 2210 2212

CPU

8085 8086 V20 8088 8400(Z80) 6502 65C02 65SC02

PERIPHERALS

8155 8156 8205 8212 8216 8226 8237 8251 8253
8254 8255 8257 8259 8279 8282 8283 8284 8286
8287 8288 8250 82450 6350 6820 6821 6822 6840
6844 6845 6850 6851 6852 6854 6520 6521 6522
6524 655165C51 8420(Z80PIO) 8430 (Z80CTC)
8440(SIO-0) 8441 (SIO-1) 8442 (SIO-2) 8449 (SIO-
90) 1852 1871 1879 2681

TRANSISTOR ARRAYS

ULN

2001 2003 2004 2005 2011 2013 2014 2015 2021
2023 2024 2025 2064 2065 2066 2067 2801 2803
2804 2805 2811 2813 2814 2815 2821 2823 2824
2825

RCA

3083 3086 75468 75491 75492

LATCH/DRIVERS

UCN4801 UCN5801

LINE DRIVERS & RECEIVERS

26LS31 26LS32 743037 743038 75174 75175 75176
75182 75183 75450 75451 75452 75453 75454 8820
8830 96174 96175

Universal Tester with LCR Meter

Order Code - 68032



68032 is the latest Micro controller based Universal IC Tester with LCR Meter. It functionally tests 74 series of TTL Ics 40 & 45 series of CMOS IC, Analog/ Linear ICs opamps, comparators, timers, transistor arrays, ADC, DAC etc., It also tests components like diode, transistors, UJT, FET, SCR, Displays, regulators, (78/79) and DIP relays. It also measures the values of Inductance (L), capacitance (C) and Resistance (R). 68032 has RS 232 Serial interface through which IC Test Library could be expanded.

Features:

- 01. Digital IC Tester to test Digital ICs TTL/ CMOS (14/16/20 Pins)
- 02. Analog IC Tester to test Linear/ analog ICs (4, 6, 8, 14, 20 Pins)
- 03. LCR Meter - Measures L, C, R, with Calibration

- Facility
- 04. Micro controller Development System
- 05. Serial Port for Upgradation
- 06. Buzzer for Bad IC indication.
- 07. Components Tester to test Diode, Transistors, SCR, UJT, FET Regulator & Displays

Technical Specification:

- Display : 40x2 Backlit Alphanumeric LCD
- Keyboard : 24 keys Membrane Keyboard
- Socket : 20 Pin ZIF Socket for DIP ICs Components Holder/ Machine base for D/L/C/R, 3 pin Machine base for Transistors, UJT, FET, SCR, 3 pin Machine base for 78XX/ 79XX Regulator
- Test Range : Digital & Linear ICs, 6, 8, 14, 16, 20 Pin in DIP Pack. Active & ssive Components
- Enclosure : Sheet Metal Cabinet with powder coating and Engraving
- Voltage : 230VAC 50 Hz ± 10%

EPROM Eraser

Order Code - 68035

General Description:

68035 is a very versatile Ultra-Violet light source, along with on time, useful as EPROM Eraser, it has electronic time and electronic driver circuits for the UV tube. Most of the EPROMs will get erased in 10 minutes, when exposed to UV light in this eraser, however on exposure of 15 minutes will give sufficient safety margins for guaranteed erasing.



Important Features:

Electronic UV tube driver circuit can tolerate a wide variation in mains supply: Typically +/- 20% (Ballast type driver circuits can not turn on the UV tube at low voltages like 220 VAC

Electronic Timer

Very convenient for use with an accuracy of better than +/- 10%

Door Safety Lock

The UV tube will be turned off whenever the EPROM Drawer is withdrawn, Thus dangerous of exposure to UV light are avoided.

Automatic Operation

This is a very important feature. You can just plug in the power cord of the EPROM ERASER into a mains outlet and forget about it. The UV light will always remain off. Whenever you want to erase any EPROMs just remove EPROM drawer, put EPROMs and slide in the drawer. The UV lights will automatically turn-on and the timer will start. After the present time is elapsed the lights will go off and remain off thereafter.

Noise Immunity

It is insensitive to minor glitches in the mains supply. The lights will remain off if they were off and on if they were on before the glitch occurred. Also whenever the

mains is turned (OFF to) ON, the UV lights will always remain off, thus allowing permanent connection of the unit to a mains outlet.

Technical Specifications:

Ultra-Violet Light Source

- Source Type : Germicidal Lamp G6T5
- Wavelength of Light : 2537 Angstrom U
- Average Power input : 5.0-5.5 Watts
- Appx. Lamp Life : 500 Hours
- Electronic Timer : 2 to 22 / 1 min. steps Timing Range
- Accuracy : +/- 10%
- Start : Auto Start by closing of EPROM drawer
- Stop : Auto Stop on Time-out- or by opening EPROM drawer

EPROM Compartment (Drawer)

- Type : Sliding with position sensing switch inside
- Active Area : 8 of 24/28 pin EPROMs
6 of 32 pin EPROMs
4 of 40 pin EPROMs

General

- Operating Power : 230 VAC +/- 20%
- Overall Dimensions : 320 x 90 (H) x 65 mm (W)
- Appx. Weight : 2200gms. (Approx)

Universal Programmer

Order Code - 68043



Features

- * USB interface with auto-switch power
- * Support 5V and 3.3V low voltage devices, 1.8V chip support through low voltage Adapter.
- * Less than 2 seconds per Mbit Programming speed for high density flash chip.
- * No adapter for DIL chip up to 48-pin
- * 48-pin universal pin driver and current limit
- * Auto-sense/ Self programming with statistical report
- * Device insertion /continuity check
- * Universal adapter for 44-pin PLCC/ QFP/ QFP/PSOP and 40/48 TSOP, Optional
- * Supports Windows 98SE / ME / 2000 / XP / Vista(32bit) / 7(32bit/ 64bit)
- * Automatic EPROM/ Flash ID search
- * Serialization for Memory/iP chip
- * Memory buffer H / L byte swap
- * Project file save / load function
- * User-selectable verify Vcc with one or Twopass verify voltage
- * Automatic file format detection and conversion.
- * User-changeable programming parameters
- * 48-pin DIL/ ZIF socket with receptacle for 8-pin to 48-pin 300/ 600-mil devices.
- * Four DACs for Vcc, Vpp1, Vpp2 and Vpp3 with 8-bit resolution. Software controllable rises time and current limit protection.
- * Logic driver supports pull-up/ pull-down or high impedance on all 48 pins with 2.0V-5V level
- * Memory : PROM, EPROM, EEPROM,Flash, Serial

PROM, NVRAM

- * Logic: PAL, GAL, CEPAL, PEEL, CDLD, EPLD
- * Others: OTP/ Flash Micro-controllers.
- * Read, blank check, device insertion/ contact check, verify, checksum, EPROM ID check, compare, erase chip, function test, program, memory protect, device configuration setting, device search, edit buffer, mass production mode, modify vector, serialization, H/L byte buffer swap, buffer search
- * Accepts JEDEC test vectors up to 48 pins
- * 2500V/usec. rise time
- * File format conversion
- * JEDEC, POB, Binary, Intel HEX, Intel EXT HEX, Motorola S, HP 64000ABS, Straight Hex, Automatic detection and conversion.

Universal IC Tester

Order Code - 68051



Features:

01. Tests a wide range of Digital IC's such as 74 Series, 40/45 Series of CMOS IC's.
02. It can test Micro- processor 8085, 8088, Z80, 6502
03. It tests Peripherals & Memory IC's like 8255, 8279, 8253, 8259, 8251, 8420, 6264, 62256, 2764, 27128, 27256
04. Tests a wide range of Analog IC's such Op-amp, 555 Timers
05. Tests a wide range of Transistor Arrays, Analog switches, Cross Point Switch.
06. Tests a wide range of Opto- couplers.
07. Tests a wide range of 8 bit ADC, 8 bit DAC, Comparators.
08. It has Auto search facility for Digital IC's.
09. Test by: Truth table/sequence table comparison.
10. ZIF: 40 pin & 28 pin DIP ZIF sockets.
11. Keys: 20 Touch-keys Key pad with numerical & functional keys.
12. Display: 16x2 LCD Display.
13. Audio alarm indication.
14. Device Supports: Supply Input Voltage: 230V AC.

Device Supports:

DIGITAL IC's

TTL IC's(74xx & 74xxx Series): 00 01 02 03 04 05
06 07 08 09 10 11 12 13 14 15 16 17 18 19 20 21 22 24
25 26 27 28 30 32 33 37 38 39 40 42 43 44 45 46 47 48
49 50 51 54 55 64 70 72 73 74 75 76 77 80 82 83 85 86
87 90 92 93 94 95 96 101 102 103 016 107 108 019 112
113 114 125 126 128 132 133 134 135 136 137 138
139 140 145 147 148 150 151 152 153 154 155 156
157 158 160 161 162 163 164 165 166 168 169 170
173 174 175 176 177 180 182 190 191 192 193 194
195 196 197 198 199 240 241 242 243 244 245 247
274 249 251 253 256 257 258 259 260 266 273 279
280 283 290 293 295 298 299 322 350 352 353 363
364 365 366 367 368 373 374 375 377 378 379 390
393 395 425 426 445 447 490 534 540 541 563 564
573 574 640 641 642 643 645 670 688

CMOS IC's (40xx & 40xxx Series): 00 01 02 06 08
09 10 11 12 13 14 15 17 18 19 20 21 22 23 24 25 26 27
28 29 30 32 33 34 35 37 38 40 41 42 43 44 48 49 50 51
52 53 63 66 68 69 70 71 72 73 75 76 77 78 81 82 85 86
93 94 95 96 99 101 102 103 104 106 107 117 147 160
161 162 163 174 175 182 192 193 194 195 257

CMOS IC's (45 Series): 4501 4502 4503 4506 4508
4510 4511 4512 4513 4514 4515 4516 4518 4519
4520 4529 4530 4531 4532 4543 4553 4554 4555
4560 4561 4572 4584 4585 4724

93 and 96 series IC's
9300 9301 9302 9309 9321 9322 9324 9346 96101
96103 96106

Microprocessor IC's
8088 8085 Z-80CPU(8400) 6502

Peripherals IC's
8155 8251 8253 8255 8259 8279 Z-80 PIO(8420) 8121
8123 8205 8212 8216 8221 8226 8555

Memory IC's
2716 2732 2764 27128 27256 27512 2147 6116 6264
62256 4164 DS7810 DS7811 DS7812 DS7819 DS8810
DS8811 DS8812 Ds8819

LINEAR IC's
Operational Amplifiers
Lm101 LM107 LM108 LM112 LM124 LM143 LM144
LM148 Lm149 LM158 LM192 LM201 LM207 LM208
LM212 LM216 LM224 Lm228 LM249 LM258 LM292
LM301 LM307 LM308 LM312 LM316 Lm324 LM343
LM344 LM348 LM349 LM351 LF356 LF357 LM358
Lm392 LM709 LM714 LM725 LM741 (8/14 pin) LM747
(10/14 pin) Lm748 LM1458 LM1558 LM2902 LM2924
LM3301 LM3401 Ha17080 HA17082 HA17083
HA17084 HA17301 HA17324 Ha17358 Ha17458
HA17474 HA17558 HA17741(8/14 pin) HA17747
HA17902 Ha17904 UCOP01 UCOP02 OP07 OP27
CA3130 CA3140 TL074 TI084

Comparators
LM111(8/14 pin) LF111 LM119 LM139LM160(8/14 pin)
LM161 Lm193 LM211(8/14pin) LF211 LM219 LM239
LM260(8/14 pin) LM261 Lm293 LM311(8/14pin) LF311
LM319 LM339 LM360 (8/14pin) LM361 Lm393 LH2111
LH2211 LH2311 LM2901 LM3302 HA17339 HA17393
Ha17901 Ha17903

Transistor Arrays
ULN2001 ULN2002 ULN2003 ULN2004 ULN2005
ULN2064 ULN2065 ULN2066 ULN2067 ULN2068
ULN2069 ULN2074 ULN2075 Td62501 TD62502
TD62503 TD62504 TD62505 TD62506 TD62507 75064
75065 75066 75067 75068 75069 75074 75075 75430
75446 75447 75448 75449 75450 75460 75465 75466
75467 75468 75469 75470 75491 75492

Opto Couplers
MCT2 MCT2E 4N25 4N26 4N27 4N28 4N32 4N33 4N35
4N36 4N37 6N135 6N136 6N137 6N138 6N139 TIL111
TIL112 TIL113 TIL114 TIL115 TIL116 TIL117 TIL118
TIL119 TIL127 TIL128 TIL153 TIL154 TIL155 TIL156
TIL157 TIL181 TIL189 TIL190 MOC3009 MOC3010
MOC3011 MOC3012 MOC3020 MOC3021 MOC3022
MOC3023 HCPL2502 HCPL2601 HCPL2630 OPI8012

OPI8013 OPI8014 OPI8015

Analog Switches
CD4016 CD4066 CD4051 CD4052 CD4053 HI200
HI201 HI300 Hi301 HI302 HI303 HI304 HI305 HI306
Hi307

Cross Point Switches
Cd22100

Voltage Followers LM102 LM202 LM302 LM110(14
pin) LM210(14 pin) LM310(8/14 pin) LM2110 LM2210
Lm2310

Timers LM555 NE555 Ha17555

A to D Converters ADC0801 ADC0802 ADC0803
ADC0804

D to A Converters DAC0800 DAC0806 DAC0807
DAC0808 HA17008R Ha17408

General Linear IC's 75182 75183 75189 DS7820A
DS8820A Ds8830 Mc1489

Linear IC Tester
Order Code - 68052



- Features:**
01. Tests a wide range of Analog IC's such Op-amp, 555 Timers.
 02. Tests a wide range of Transistor Arrays, Analog switches, Cross Point Switch.
 03. Tests a wide range of 8 bit ADC, 8 bit DAC, Comparators.
 04. Test by: Truth table/sequence table comparison.
 05. ZIF: 28 pin DIP ZIF sockets.
 06. Keys: 20 Touch-keys Key pad with numerical & functional keys.
 07. Display: 16x2 LCD Display
 08. Audio alarm indication.
 09. Supply Input Voltage: 230V AC.

Device Supports:
LINEAR IC's
Operational Amplifiers
Lm101 LM107 LM108 LM112 LM124 LM143 LM144
LM148 Lm149 LM158 LM192 LM201 LM207 LM208
LM212 LM216 LM224 Lm228 LM249 LM258 LM292
LM301 LM307 LM308 LM312 LM316 Lm324 LM343
LM344 LM348 LM349 LM351 LF356 LF357 LM358
Lm392 LM709 LM714 LM725 LM741 (8/14 pin) LM747
(10/14 pin) Lm748 LM1458 LM1558 LM2902 LM2924
LM3301 LM3401 HA17080 Ha17082 HA17083
HA17084 HA17301 Ha17324 HA17358 HA17458
Ha17474 HA17558 HA17741(8/14 pin) HA17747
HA17902 HA17904 UCOP01 UCOP02 OP07 OP27
CA3130 CA3140 TL074 TI084

Comparators
LM111(8/14 pin) LF111 LM119 LM139LM160(8/14 pin)
LM161 Lm193 LM211(8/14pin) LF211 LM219 LM239
LM260(8/14 pin) LM261 Lm293 LM311(8/14pin) LF311

LM319 LM339 LM360 (8/14pin) LM361 Lm393 LH2111
LH2211 LH2311 LM2901 LM3302 HA17339 HA17393
Ha17901 Ha17903

Transistor Arrays

ULN2001 ULN2002 ULN2003 ULN2004 ULN2005
ULN2064 ULN2065 ULN2066 ULN2067 ULN2068
ULN2069 ULN2074 ULN2075 Td62501 TD62502
TD62503 TD62504 TD62505 TD62506 TD62507 75064
75065 75066 75067 75068 75069 75074 75075 75430
75446 75447 75448 75449 75450 75460 75465 75466
75467 75468 75469 75470 75491 75492

Opto Couplers

MCT2 MCT2E 4N25 4N26 4N27 4N28 4N32 4N33 4N35
4N36 4N37 6N135 6N136 6N137 6N138 6N139 TIL111
TIL112 TIL113 TIL114 TIL115 TIL116 TIL117 TIL118
TIL119 TIL127 TIL128 TIL153 TIL154 TIL155 TIL156
TIL157 TIL181 TIL189 TIL190 MOC3009 MOC3010
MOC3011 MOC3012 MOC3020 MOC3021 MOC3022
MOC3023 HCPL2502 HCPL2601 HCPL2630 OPI8012
OPI8013 OPI8014 OPI8015

Analog Switches

CD4016 CD4066 CD4051 CD4052 CD4053 HI200
HI201 HI300 Hi301 HI302 HI303 HI304 HI305 HI306
Hi307

Cross Point Switches

Cd22100

Voltage Followers LM102 LM202 LM302 LM110(14
pin) LM210(14 pin) LM310(8/14 pin) LM2110 LM2210
Lm2310

Timers LM555 NE555 Ha17555

A to D Converters ADC0801 ADC0802 ADC0803
ADC0804

D to A Converters DAC0800 DAC0806 DAC0807
DAC0808 HA17008R Ha17408

General Linear IC's 75182 75183 75189 DS7820A
DS8820A Ds8830 Mc1489

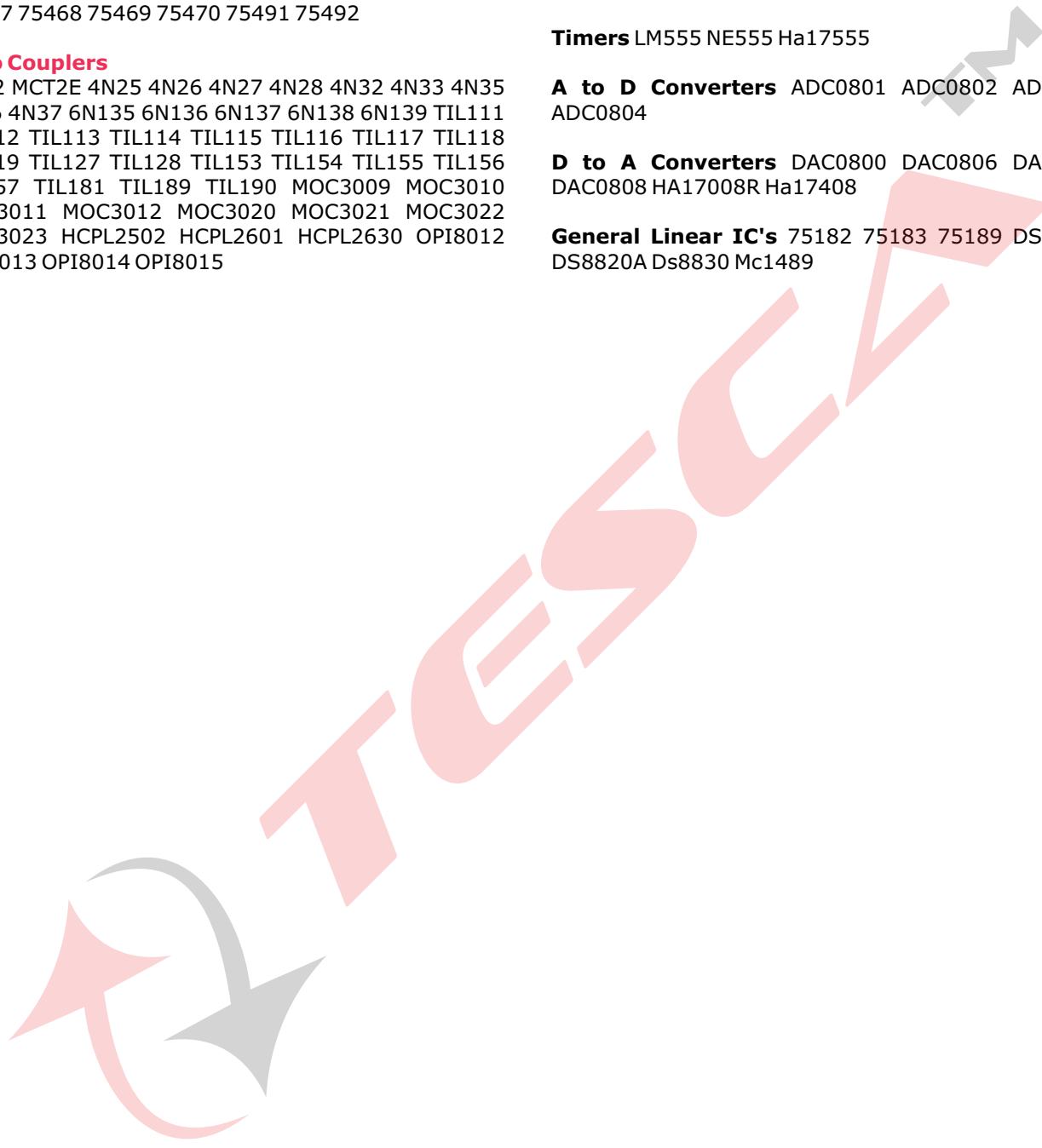

 <p>Digital Multimeters</p>	 <p>Logic Probes</p>	 <p>AC/DC Power Supplies</p>
 <p>Semiconductor Component Checker and Curve Tracer</p>	 <p>Electronic Coulomb Meter (Charge Measuring Device)</p>	 <p>Signal Generators</p>
 <p>Digital Clamp Meters</p>	 <p>Lux Meters</p>	 <p>Digital Nanometer</p>
 <p>Infrared Thermometers</p>	 <p>Tachometers</p>	 <p>Digital Insulation Testers</p>
 <p>LCR Meters</p>	 <p>Ohmmeters</p>	 <p>Transformer Turns Ratio Meters</p>
 <p>Automotive Battery Meters</p>	 <p>Solar Module / Solar System Analyzer</p>	 <p>Digital & Analog Oscilloscopes</p>

 <p>Spectrum Analyzers</p>	 <p>Frequency Counters</p>	 <p>Programmable DC Electronic Lods</p>
 <p>Environment Testing Instruments</p>	 <p>Power and Harmonics Analyzers / Testers</p>	 <p>Calibrating Equipment</p>
 <p>Clamp - On CT's and Flexible AC Current Probes</p>	 <p>Digital Multifunction Meters</p>	 <p>Oil Insulation Tester</p>
 <p>Analog Portable Meters</p>	 <p>Digital Portable Meter</p>	 <p>Educational Desk Stand Meters</p>



Decade Boxes (R, L, C)

Order Code - 19001-07, 19051-19053, 19100



Decade Resistance Boxes

Decade Resistance Boxes are precision instruments intended for general laboratory use, R&D and educational purposes. These are used as a multiplier, shunt, substitution resistor, or as an arm for AC or DC bridges.

Specifications:

- * Metal Film Resistor Accuracy : $\pm 1\%$
- * Power Rating : 1Watt
- * Maximum Working Voltage : 500 Volts.

Model	In Steps of	Total Resistance
-------	-------------	------------------

Nine Dials (Total Steps : 90)

19006 1W 1,11,11,11,110W

Eight Dials (Total Steps : 80)

19001 1W 11,11,11,110W

19007 0.01W 11,11,111.1W

Six Dials (Total Steps : 60)

19002 1W 11,11,110W

19003 100W 11,11,11,000W

Four Dials (Total Steps : 40)

19004 1W 11,110W

19005 10KW 11,11,00,000W

Decade Inductance Boxes

Decade Inductors Boxes are used in Education & Research of electronic circuits, tuned circuits, wavefilters, equalizers, oscillators, frequency analyzers in the range of audio and low radio frequencies, as an alternative to determine optimum inductance values.

Specifications:

- * Accuracy : $\pm 2\%$ at 1KHz
- * Watt/Volt : 1/2W (150VPP)
- * Max. current for 0.01, 0.1, 1mH= 730mA, 10,100mH= 100 mA, 1H= 20mA

Common Features:

- * 2 jack-topped binding posts are used as output terminals and 1 terminal has been provided for grounding

Model	In Steps of	Total Inductance
-------	-------------	------------------

Three Dials (Total Steps : 40)

19050 1mH 1.11H

Four Dials (Total Steps : 40)

19051 1mH 11.11H

Five Dials (Total Steps : 50)

19052 0.1mH 11.111H

Six Dials (Total Steps : 60)

19053 0.01mH 11.1111H

Decade Condenser Boxes

Decade Condensers comprise of high quality Polyester Condensers. The units can be used for experimental purpose in turned circuits, wave filters, oscillators, analyzers, amplifiers, equalizers and experimental hook-ups in laboratory work.

Specifications:

- * Accuracy : $\pm 1\%$
- * Max. D.C. Voltage : 400Volts
- * Dielectric : Polystyrene

Model	In Steps of	Total Microfarads
-------	-------------	-------------------

Two Dials (Total Steps : 20)

19101 0.01mF 1.1mF

Five Dials (Total Steps : 50)

19100 0.0001 11.111

Six Dials (Total Steps : 60)

19102 0.0001 111.111

 <p>Electronics Tool Kit</p>	 <p>Soldering Irons</p>	 <p>Coil Winding Machines</p>
 <p>Adjustable Spanners</p>	 <p>All Type Pliers</p>	 <p>Screw Drivers</p>
 <p>Screw Driver Bits</p>	 <p>Square Drive Socket</p>	 <p>Socket Accessories</p>
 <p>Wrenches</p>	 <p>Hammer</p>	 <p>C, F - Clamp</p>
 <p>Spanners</p>	 <p>Double Ended & Ring Spanners</p>	 <p>Chisels, Punches, Centre Punch</p>
 <p>Magnetic Products</p>	 <p>Bolt Cutters</p>	 <p>Knife & Cutter Blade</p>

 <p>Gear Pullers</p>	 <p>Allen & T- Handle Keys</p>	 <p>Tools Box & Iroiley</p>
 <p>Spirit Levels</p>	 <p>Cutting Blade</p>	 <p>SDS Hammer Drill Bits</p>
 <p>Steel File</p>	 <p>Non Sparking Tools</p>	 <p>Safety Boots</p>
 <p>Electric Pipe Threading Machine</p>	 <p>Die & Die Head For Pipe Threading Machine</p>	 <p>Oil Guns</p>
 <p>Thread Nipple Holders</p>	 <p>Adapter For Close Threading Nipples</p>	 <p>Portable Electric Pipe Threader with Die & Die Head</p>
 <p>Pipe Stands</p>	 <p>Hydraulic Thread Rolling Machine</p>	 <p>Thread Cutting Oil</p>

 <p>Universal Electric Pipe Grooving Threading Machines</p>	 <p>Digital Voltage Stabilizer</p>	 <p>Pipe Saw For Stainless Steel Pipe</p>
 <p>Ratchet Pipe Thread</p>	 <p>Hand Pvc Pipe Threader</p>	 <p>Ratchet Pipe Hammer</p>
 <p>Pipe Vices</p>	 <p>Pipe Vice Stands</p>	 <p>Pipe Vice Tristands</p>
 <p>Bench Vices</p>	 <p>Chain Vices</p>	 <p>Pipe Lifters</p>
 <p>Load Benchers</p>	 <p>Pipe Wrenches</p>	 <p>Hacksaw Blade & Frames</p>
 <p>Tire Scraper Tools</p>	 <p>Bolt Cutter</p>	 <p>Sheet Hole Cutter</p>

 <p>Pipe Reamers</p>	 <p>Tube Cutters</p>	 <p>Plastic Pipe Cutters</p>
 <p>Pipe Welding Set</p>	 <p>Pipe Welding Machines</p>	 <p>Gasoline Pipe, Pillars & Road Cutter</p>
 <p>Electric Concrete Cutters</p>	 <p>Diamond Core Drillers For Concrete</p>	 <p>Gas Pipe Cutting Machines</p>
 <p>Electric Metal Saw</p>	 <p>Pipe Hole Cutting Machine</p>	 <p>Hydraulic Under Pressure Drilling Machine Auto Feeding With Power Pack</p>
 <p>Ratchet Drill Machine Multipurpose</p>	 <p>Combined Tap Drill</p>	 <p>Water Pump Pliers</p>
 <p>Grease Guns</p>	 <p>Oil Can</p>	 <p>Rotary Barrel Pump</p>

 <p>Iron Jack & Block Plane</p>	 <p>Tin Cutter & Pincers</p>	 <p>Tubular Axes</p>
 <p>Anvil</p>	 <p>Chain Pully Block</p>	 <p>Brushes</p>
 <p>Handy Cleaner</p>	 <p>Economy Toilet Auger</p>	 <p>Power And Cordless Handy Cleaner</p>
 <p>Rod Pipe Cleaner</p>	 <p>Spare Cutters For Mini & Heavy Power Rooter</p>	 <p>Automatic Power Pipe Cleaner Mini Rooter</p>
 <p>Long Distance Power Pipe Cleaner</p>	 <p>Pipe Benders</p>	 <p>Spare Bending Formers</p>
 <p>2 Way Tube Bender</p>	 <p>Spring Tube Bender</p>	 <p>Tube Roller Bender</p>



Circle Making Machine



Special Purpose Hydraulic Pipe Bender



Bending Radius Gauge



Reinforcement Bar Bending Machine



Reinforcement Bar Braking Machine



Portable Reinforcement Hydraulic Bar Cutter



Gasoline Concrete Mixer



Tapping Machine



Hydraulic Press



Hydraulic Hand Pallet Trucks

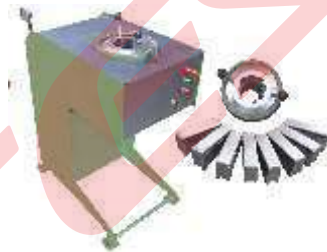

Hydraulic Hose Crimping Machine



Hydraulic Crimping Plier

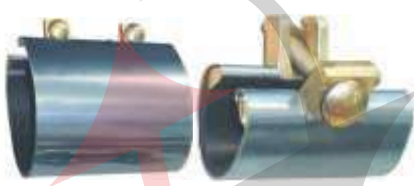

Puncture Pipe Repair Clamps



Electric Hoist



Electric Trolley



Hand, Electric & Battery Winch



Drill Machines



Drill & Professional Hammer

 <p>Angle Grinder</p>	 <p>Sander Polisher/Waxer</p>	 <p>Marble & Slot Cutter</p>		
 <p>Orbital Sander</p>	 <p>Electric Router</p>	 <p>High Pressure Washer & Blower</p>		
 <p>Cordless Circular Saw</p>	 <p>Chain Saw For Tree Service With Petrol Engine</p>	 <p>Clear Scope Digital</p>		
 <p>Iron & Aluminium Level</p>	 <p>Square</p>	 <p>Figure & Letter Set</p>		
 <p>Scales</p>	 <p>Scraper Brass Plane</p>	 <p>Inside & Digital Micro Meter</p>		
 <p>Depth Gauge</p>	 <p>Callipers</p>	 <p>Scissors</p>	 <p>Pocket & Tool Bag</p>	 <p>Canadian Gloves</p>

Electricity

 <p>Post Office Box</p>	 <p>Determination of Internal Resistance of Primary Cell</p>	 <p>Determination of Mechanical Equivalents</p>
 <p>Study of Resonance in LCR Circuit and Damping Effect</p>	 <p>Study of Rise and Decay of Current in an Inductive Circuit & Plotting Curves</p>	 <p>Determination of Hysteresis Loss of a Transformer by C.R.O.</p>
 <p>Determination of the Ballistic Constant of a Ballistic Galvanometer</p>	 <p>Measurement of Resistivity of Semiconductor</p>	 <p>Hall Effect Experimental Training Set</p>
 <p>Temperature Co-Efficient of Resistance of Conductors</p>	 <p>Conductivity of a Solution</p>	 <p>Lattice Dynamics Through Electrical Analogue</p>
 <p>Demountable Transformer</p>	 <p>Induction Accessories Set</p>	 <p>Ring Launcher</p>
 <p>Power Supplies</p>	 <p>Solenoid</p>	 <p>Magnetizing/ Demagnetizing Coil</p>

Electricity



Wimshurst Machine



Plug Type Resistance Boxes



Potentiometers



Tangent Galvanometer



Joule Meter



Screw Drivers



Basic Electricity Kit



Current and Voltage Sources



Transistors as Amplifier



Demonstration Dynamo AC/DC



Magnets



Magnetic Compass In An Aluminium Case

Energy

 <p>Solar & Wind Energy Trainers</p>	 <p>Immersion Heater</p>	 <p>Hand Wheel Driving Unit</p>
 <p>Mounted Solar Cell</p>	 <p>Calorimeter Joule's</p>	 <p>Half Life Analogue</p>
 <p>Spark Discharge Apparatus</p>	 <p>Melting Point Apparatus</p>	 <p>Model of Thermostat</p>
 <p>Wood And Metal Cylinder</p>	 <p>Ingen - Hausz's Apparatus</p>	 <p>Determination of Stefan`s constant</p>
 <p>Bar and Gauge</p>	 <p>Thermopile</p>	 <p>Metal Rivets</p>
 <p>Expansion of Liquid Apparatus</p>	 <p>Gunther's Apparatus</p>	 <p>Engine Models</p>

Light

 <p>Light Box With Fixed Mirror</p>	 <p>Laser Kit</p>	 <p>Set Of Coloured Cards</p>
 <p>Circular Block</p>	 <p>Spectrum Tube Power Supply</p>	 <p>Spectrometers</p>
 <p>Laurent's Half Shade Polarimeter</p>	 <p>Compact Quartz Polarimeter</p>	 <p>Polarimeter</p>
 <p>Optical Bench</p>	 <p>Fixed, Transverse Saddle</p>	 <p>Optical Bench Wooden With Lamp House</p>
 <p>Optical System</p>	 <p>Object Needle Mounted</p>	 <p>Lenses Holder</p>
 <p>Pin Hole Camera Wooden</p>	 <p>LED Array</p>	<p>And Many More... Visit Our Website www.tescaglobal.com</p>



Free Fall Apparatus



Vibration Generator



Wave Form Helix Slinky & Wooden Stand



Wave Demonstration Apparatus



Pump Plate For Bell Experiment



Magdeburg Hemispheres Plastic

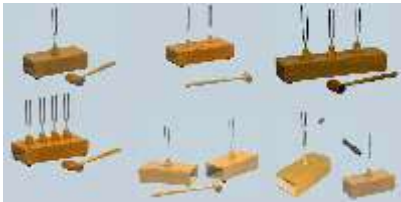

Tuning Fork on Resonance Box



Sonometer Wooden



Melde's Apparatus



Boyle's Law Apparatus



Density Set



Metal Cylinder Set Equal In Mass



Spherometer



Horizontal & Vertical Travelling Microscope



Force Table



Dynamic Trolley Metallic With Mass



Inclined Plane With Scale



Pulleys With Hook Set



Microscopes



Mechanical Stage Standard



Dissecting Instruments



Kymograph Electrical



Microscope Slides

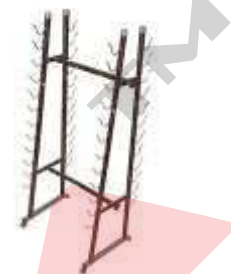
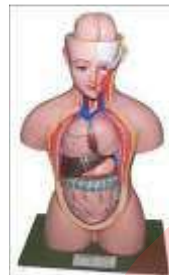

Chart Stand



Chart



Human Torso



Human Skeleton With Stand



Model of Human Eye



Human Brain



Human Lungs



DNA Model



Animal Cell



Frog Dissection



2 Way Tube Bender



Rabbit Skull



Micro Biology Kit

And Many More...

Variac - Single Phase Flush Back of Panel Open

Order Code - F1



Variac - Single Phase Portable Table / Floor Mounting Enclosed

Order Code - P1



Variac - Three Phase Flush Back of Panel

Order Code - F3



Variac - Three Phase Portable Table / Floor Mounting Enclosed



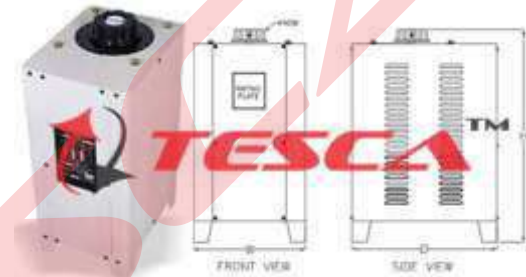

Order Code - P3



		Input 230V A.C., Output 270V A.C., 50-60Hz		Input 415V A.C., Output 470V A.C., 50-60Hz	
S. No.	Output Current Rating in Amps	F1- Variac - Single Phase Flush Back of Panel, Open	P1- Variac - Single Phase Portable Table/Floor Monuting Enclosed	F3- Variac - Three Phase Flush Back of Panel,Open	P3- Variac - Three Phase Portable Table/Floor Monuting Enclosed
1	0.75A	0.75F1	0.75P1	0.75F3	0.75P3
2	1A	1F1	1P1	1F3	1P3
3	2A	2F1	2P1	2F3	2P3
4	3A	3F1	3P1	3F3	3P3
5	4A	4F1	4P1	4F3	4P3
6	5A	5F1	5P1	5F3	5P3
7	6A	6F1	6P1	6F3	6P3
8	8A	8F1	8P1	8F3	8P3
9	10A	10F1	10P1	10F3	10P3
10	15A	15F1	15P1	15F3	15P3
11	17.5A	17.5F1	17.5P1	17.5F3	17.5P3
12	20A	20F1	20P1	20F3	20P3
13	28A	28F1	28P1	28F3	28P3
14	40A	40F1	40P1	40F3	40P3
15	50A	50F1	50P1	50F3	50P3

 <p>Active Networks</p>	 <p>Laptops & Desktop PC</p>	 <p>Passive Network - Cat6/Patch Panel</p>
 <p>Printers</p>	 <p>Projectors</p>	 <p>Racks</p>
 <p>ThinClient & Nodes</p>	 <p>UTM Hardware Firewall</p>	 <p>Video Conferencing</p>

Web & Software Application

 <p>Mobile Applications</p>	 <p>Website Development</p>
 <p>ERP Solution</p>	 <p>IT Solution</p>



Tesca Learning Platform

One Platform to Meet all Your Online Learning and Live Classroom Needs



Features at a glance:

- Join Courses and Access Valuable Course-Ware
- Enhance Learning with Tests and Quizzes
- Quick Grading
- Issue Online Certificates
- Analyze Progress with Report That Make Sense
- Dashboards
- Reliable and Secure
- Connect Live With Instructors
- View Instructors Shared Files And
- Learning Material in Virtual Live Classroom
- Curriculum Management
- Student Tracking
- Collaborative Learning
- Easy To Use and Manage



Online E-Learning Solutions

An easy to use system to train your students, employees, partners or customers.

Tesca Classroom Management System (CMS)

Tesca Classroom Management System (CMS) is new generation of software that assists teachers in utilizing and managing a computer multimedia lab or 1:1 classroom. It transforms traditional classrooms into educational platforms which allow students to develop 21st Century skills and teachers to manage an ICT rich classroom without compromising the way they naturally would like to teach. CMS should utilize cutting edge features which allow for a broad range of learning techniques and communication methods, while harnessing features such as screen-spying, broadcasting, computer/screen locking, file sharing, and many more to maximize learning effectiveness in a 21st Century classroom.

Specification:

CMS supports additional apps which are able to be purchased directly from the website provider administrator. While, not a comprehensive platform, these apps help educators who want to bring specific 21st Century Elements into the classroom. Examples of these apps are:

- Polling: Using any device, teachers will be able to immediately poll their students to get real time responses and assessment.
- Digital Whiteboard: Teachers can use their device to replicate many of the same features as a digital whiteboard at a fraction of the cost. Now a teacher can use ICT in their demonstrations with minimal infrastructure.
- Exam Creation: Teachers can build exams for students using exam authoring tools.
- Exam Dissemination: Teachers can digitally disseminate exams to their students and retrieve them for automatic scoring.
- Compatibility:
 - Windows 7
 - Windows 8
 - Windows XP
 - Linux
 - Android mobile devices
 - Local, Not online & No Server Needed
- Devices Control Features
- Learner Monitoring Features
- Device Sharing Features
- Utility Features
- Learner Features Summary
- Administration:
 - Differentiated Instruction

Tesca Learning Management System (LMS)

Features:

The Tesca LMS is comprehensive education tool designed to enrich courses by embedding digital content and assessments into traditional teaching and learning. A full suite of content creation tools is included to enable instructors and instructional designers to enhance their courses with customized digital content. Scheduling, communication, and web 2.0 tools allow multiple options for students and instructors to meet The diverse needs of learners in the 21st Century.

The LMS incorporates many instructor friendly features which enable complete course delivery or supplemental course materials. Instructors are able to design their own curriculum, modify content, and import SCORM compliant modules for students to view. Instructors have complete control over content, assessment and grading scales. The LMS content delivery system tracks individual students' progress as they are guided through technology rich curriculum, which enhances 21st Century Skill competency, in addition to ensuring students meet the required learning outcomes of the course.

The LMS is a versatile learning platform which supports 21st Century learning models such as blended learning, and flipping the classroom. This flexibility enables institutions to create the most valuable learning opportunities possible and to maximize student capacity for independent learning.

Specifications:

- WEB 2.2 Tools:
- Curriculum Development
- Instruction Design
- Content Delivery



All Courses:

Course Status Report:

Reports from Admin Dashboard:

Admin Dashboard:

User Enrollment:



Installations Worldwide

Services

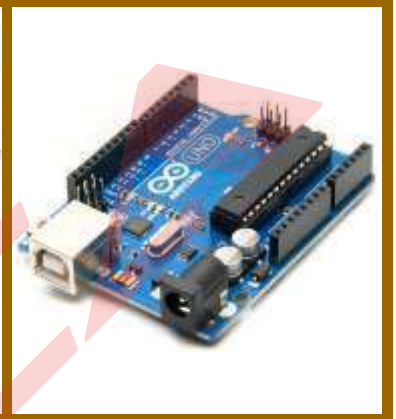

Agri. Products



Milk Analyser



Digital Soil Testing Mini Lab



Vermi Compost Bio Fertiliser



On - Grid Solar Power Plant



Solar Panels



All in One Solar Light



Solar Street Light



Solar Street Light- High Mast



Solar Water Heater



Solar Lantern



Solar Power Inverter



Solar Home Lighting System



Advance Solar Home Lighting System



Solar Water Pump



LED Tubelight (non Solar)



LED bulb (non Solar)



Beakers



Burette



Pipette Pumps



Bottles



Flasks



Jar



Clamps



Funnel Holders



Flask Stand

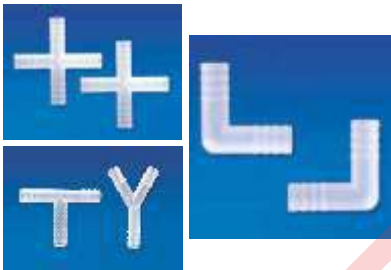

Connectors



Pinch Clip



Cages



Retort Stand



Desiccators



Stop Cocks



Kipp`s Apparatus



Funnels



Petri Dishes

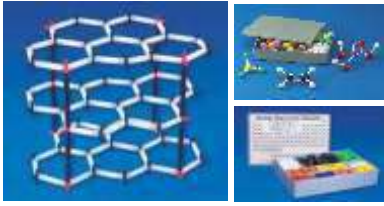

Model Sets

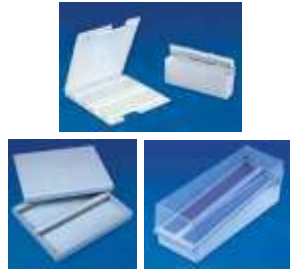

Slide Mailers, Boxes & Rack

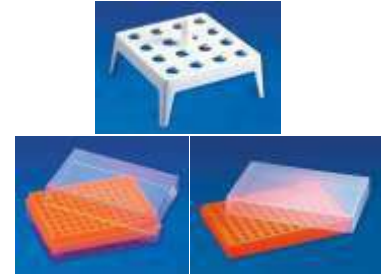

Float, Twin, & Tube Racks



Centrifuge Tubes



Containers



Vials

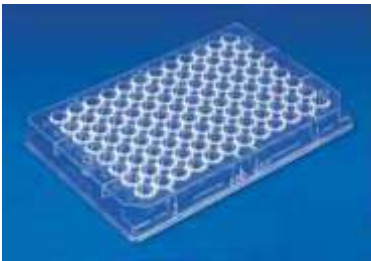

Test Plates



Rack for Petri Dishes



Multi Rack



Multy Type Stands

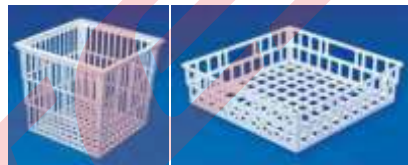

Baskets



Pipette Stand



Universal Reagent Reservoir



Staining Box



Measuring Cylinders



Measuring Jugs



Seperatory Funnel



Scoop & Spatula



Stirrer, Stirring Rods, Spreader



Micro Pestle



Pneumatic Trough



Pots



Tray

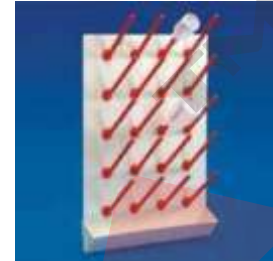

Draining Rack



Storage Boxes



Medicine Cup

**For More Details
visit our Website www.tesca.in**

Soil Testing Range



Automatic Free Fall Hammer



High Speed Stirrer



Sieve Shaker



Direct Shear Apparatus



Digital Static Cone Penetrometer



Sieves Set

Rock Testing Range



Core Cutting & Grinding Machine



Rock Permeability



Point Load Index Tester



Electronic Kit for Rock Triaxial Test



Triaxial Testing of Rocks



Rock Direct Shear

Geotextile Testing Range



Cone Drop Test Apparatus



In-Plane Permeability Test Apparatus



Long Term Flow Test Apparatus



Gradient Ratio Test Apparatus



Geotextile Penetrometer

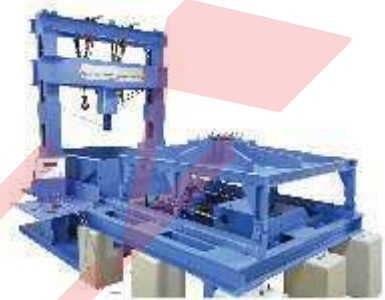

Large Pull Out Test Apparatus

Concrete Testing Range



Core Cutting & Grinding Machine



Slump Test Apparatus



Concrete Mixer, Pan Type



Vibratory Compaction



Portable Compression Testing Machine



Vibratory Hammer

Cement, Lime Plaster & mortar Testing Range



Vibration Machine



Preparation of Flexural Prisms



Jaw Crusher



Crushing & Grinding



Permeability



Fineness of Fly Ash

Sand, Aggregate & Fillers Testing Range Testing Range



Polished Stone Value



Deval Abrasion Testing Machine



Tile Abrasion Testing Machine



Los Angeles Abrasion Testing Machine with Abrasive Charge



Aggregate Impact Value



Tile Flexure Strength Testing Machine

Asphalt Quality Control Testing Range



Abel Flash Point Apparatus



Penetration Cone



Redwood Viscometer



Flow Cup



Modified Marshall Apparatus



Core Drilling

Material Testing Range



Universal Testing Machine



Brinell Cum Rockwell Hardness Tester



Crushing Strength of Iron Ore Pellets



Torsion Testing Machine



Pendulum Impact Tester



Fatigue Testing Machine

Hydraulic Lab Testing Range



Bernoulli`s Theorem Apparatus



Metacentric Height Apparatus



Reynold`s Apparatus



Discharge Over Notches Apparatus



Impact of Jet on Vanes Apparatus

And Many More...



sales 85+ countries

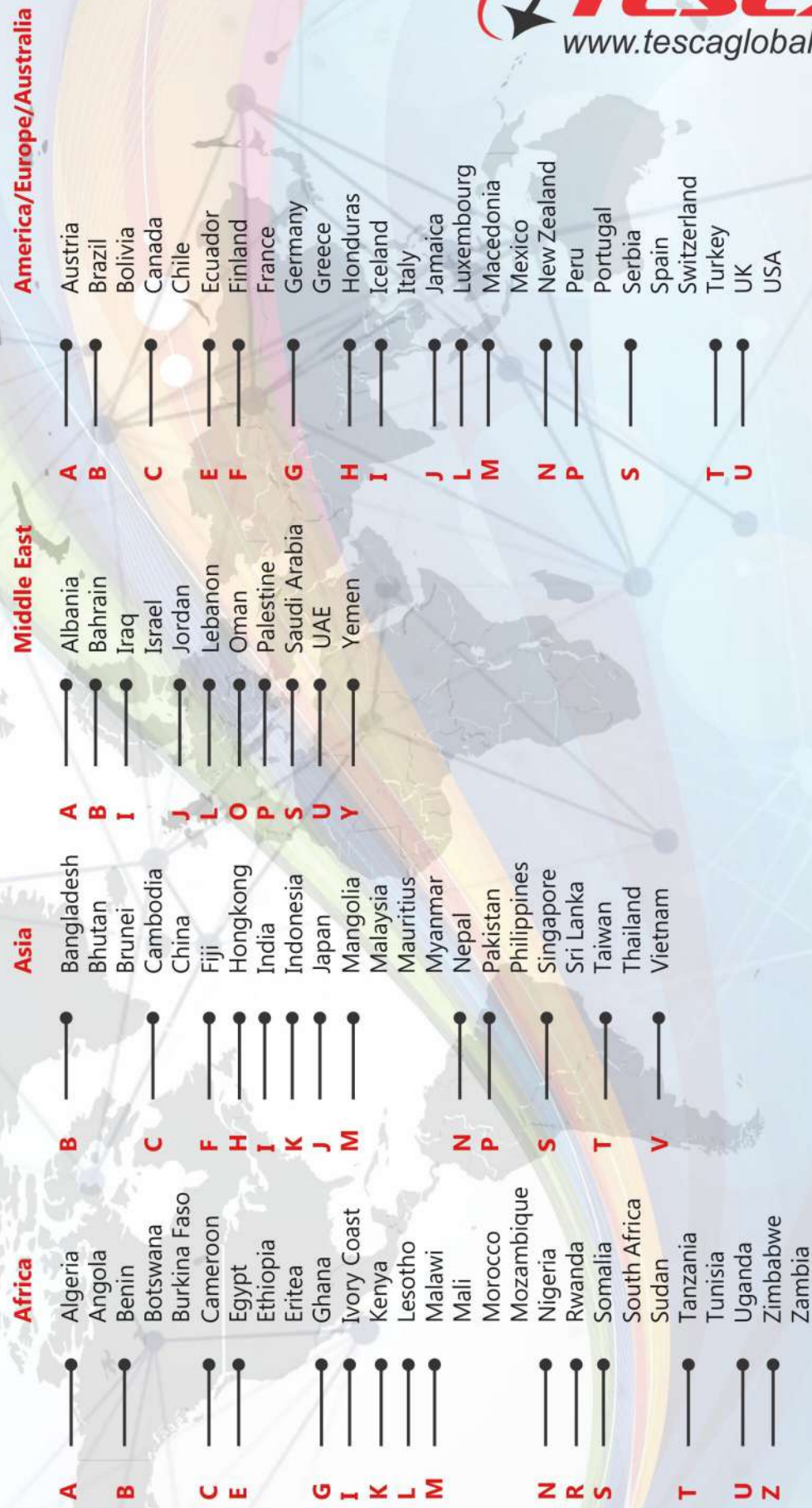



Electrical Machine
Trainer - 46800



Fire Alarm Trainer
46624A



Air Conditioning Trainer
10947A



Function Generator
FG-1515



Electro Pneumatic Workbench
52104B



Digital Trainer
33504



Tesca Technologies Pvt. Ltd.

IT-2013, Ramchandrapura Indl. Area,
Sitapura Extension, Jaipur-302022, India
Ph: +91-9413330765, +91-9829132777
Email: info@tesca.in
Web: www.tescaglobal.com



SCAN ME